

SIEMENS

Data Book 1980/81

Transistors

SIEMENS

Transistors

Data Book 1980/81

**Published by Siemens AG, Bereich Bauelemente, Produkt-Information,
Balanstraße 73, D-8000 München 80**

For the circuits, descriptions, and tables indicated no responsibility is assumed as far as patents or other rights of third parties are concerned.

The information in this data book describes the type of component and shall not be considered as assured characteristics. Terms of delivery and rights to change design reserved.

For questions on technology, delivery and prices please contact the Offices of Siemens Aktiengesellschaft in the Federal Republic of Germany and Berlin (West) or the Siemens Companies and Representatives abroad (see list of Sales Offices).

The sign \emptyset on drawings denotes diameter.

A comma in the outline drawings and tables represents the decimal point.

Contents

1. Indexes	
1.1. Application Reference Index	5
1.2. Index of Types in Alphanumerical Order	13
2. Introduction	
2.1. Designation Code for Semiconductors	31
2.2. Explanation of the Terms 'Maximum Ratings' and 'Characteristics'	32
2.3. Notation and List of the Symbols and Terms Used	33
2.3.1. Symbols	33
2.3.2. Alphabetical list of the symbols used	37
2.3.3. Alphabetical list of the terms used	42
2.3.4. Explanation of the symbols and terms used	47
2.4. Technical Explanations	48
2.4.1. Basic transistor configurations	48
2.4.2. Permissible total power dissipation of transistors	50
2.4.3. Permissible operating range	55
2.4.4. Heat dissipation of transistors	56
2.4.5. Switching characteristics of transistors	57
2.4.6. The transistor as linear two-port	60
2.5. Quality Data on the Components	66
2.6. Mounting Instructions	69
3. Data Sheets (in alphanumerical order)	73
4. List of Sales Offices	967

1.1. Application Reference Index

Application Reference Index

Type	Page	Type	Page
Germanium AF Transistors		BC 167	158
AC 121	75	BC 168	158
AC 151	81	BC 169	158
AC 151r	81	BC 177	161
AC 152	75	BC 178	161
ACY 23	87	BC 179	161
ACY 32	87	BC 182	169
ASY 48	133	BC 183	169
ASY 70	133	BC 201	172
		BC 202	172
Germanium RF Transistors		BC 203	172
AF 106	93	BC 212	180
AF 109R	99	BC 213	180
AF 139	104	BC 237	183
AF 239	112	BC 238	183
AF 239S	118	BC 239	183
AF 240	122	BC 257	191
AF 279S	125	BC 258	191
AF 280S	127	BC 259	191
AF 289	129	BC 307	194
AF 379	131	BC 308	194
		BC 309	194
Silicon AF Transistors		BC 327	202
BC 107	135	BC 328	202
BC 108	135	BC 337	206
BC 109	135	BC 338	206
BC 121	143	BC 368	210
BC 122	143	BC 369	213
BC 123	143	BC 413	216
BC 140	150	BC 414	216
BC 141	150	BC 415	223
BC 160	154	BC 416	223
BC 161	154	BC 546	236
		BC 547	236
		BC 548	236
		BC 549	236
		BC 550	236
		BC 556	242
		BC 557	242
		BC 558	242
		BC 559	242
		BC 560	242

Type	Page	Type	Page
Silicon AF transistors		BCX 71	283
BC 635	252	BCX 71R	283
BC 636	256	BCX 73	338
BC 637	252	BCX 74	338
BC 638	256	BCX 75	342
BC 639	252	BCX 76	342
BC 640	256	BCX 78	346
BCW 60	276	BCX 79	346
BCW 60F	276	BCX 94	300
BCW 60R	276	BCY 58	352
BCW 61	283	BCY 59	352
BCW 61F	283	BCY 65E	352
BCW 61R	283	BCY 66	358
BCW 65	290	BCY 67	365
BCW 65R	290	BCY 77	371
BCW 66	290	BCY 78	371
BCW 66R	290	BCY 79	371
BCW 67	295		
BCW 67R	295	Silicon AF power	
BCW 68	295	transistors	
BCW 68R	295	2N 3055	957
BCX 22	300	BD 135	378
BCX 23	304	BD 136	383
BCX 24	300	BD 137	378
BCX 39	304	BD 138	383
BCX 41	308	BD 139	378
BCX 41R	308	BD 140	383
BCX 42	312	BD 287	388
BCX 42R	312	BD 288	388
BCX 51	316	BD 329	392
BCX 52	316	BD 330	395
BCX 53	316	BD 424	398
BCX 54	320	BD 429	401
BCX 55	320	BD 430	405
BCX 56	320	BD 433	409
BCX 58	324	BD 434	414
BCX 59	324	BD 435	409
BCX 68	330	BD 436	414
BCX 69	334	BD 437	409
BCX 70	276	BD 438	414
BCX 70R	276	BD 439	409
		BD 440	414

Application Reference Index

Type	Page	Type	Page
Silicon AF power transistors		BUX 28	900
BD 441	409	BUX 80	903
BD 442	414	BUX 81	903
BD 487	419	BUX 82	908
BD 488	419	BUX 83	908
BD 524	423	BUX 84	913
BD 611	425	BUX 85	913
BD 612	429	BUX 86	918
BD 613	425	BUX 87	918
BD 614	429		
BD 615	425	Complementarily paired	
BD 616	429	AF transistors	
BD 617	425	BC 140/BC 160	150
BD 618	429	BC 141/BC 161	150
BD 619	425	BC 337/BC 327	206
BD 620	429	BC 338/BC 328	206
BD 825	449	BD 135/BD 136	378
BD 826	454	BD 137/BD 138	378
BD 827	449	BD 139/BD 140	378
BD 828	454	BD 329/BD 330	392
BD 829	449	BD 429/BD 430	401
BD 830	454	BD 433/BD 434	409
BDW 25	479	BD 435/BD 436	409
BDX 27	486	BD 437/BD 438	409
BDX 28	486	BD 439/BD 440	409
BDX 29	486	BD 441/BD 442	409
BDX 30	486	BD 611/BD 612	425
BDY 12	479	BD 613/BD 614	425
BDY 13	479	BD 615/BD 616	425
BU 205	884	BD 617/BD 618	425
BU 208	886	BD 619/BD 620	425
BU 208A	886	BD 643/BD 644	433
BU 326A	890	BD 645/BD 646	433
BU 426	893	BD 647/BD 648	433
BU 426A	893	BD 649/BD 650	433
BU 626A	896	BD 675/BD 676	441
BUW 70	898	BD 677/BD 678	441
BUW 71	898	BD 679/BD 680	441
BUW 72	898	BD 825/BD 826	449
		BD 827/BD 828	449
		BD 829/BD 830	449

Type	Page	Type	Page
Silicon AF Darlington transistors		Silicon switching transistors	
BC 518	230	2N 2218	926
BC 517	233	2N 2218A	926
BC 617	248	2N 2219	926
BC 618	248	2N 2219A	926
BC 875	260	2N 2220	932
BC 876	264	2N 2221	932
BC 877	260	2N 2221A	934
BC 878	264	2N 2222	932
BC 879	260	2N 2222A	934
BC 880	264	2N 2904	938
BCV 26	268	2N 2904A	940
BCV 27	272	2N 2905	938
BCV 46	268	2N 2905A	940
BCV 47	272	2N 2906	945
BD 643	433	2N 2906A	947
BD 644	437	2N 2907	945
BD 645	433	2N 2907A	947
BD 646	437	2N 3019	952
BD 647	433	2N 4033	961
BD 648	437	BFP 22	651
BD 649	433	BFP 23	653
BD 650	437	BSS 63	824
BD 675	441	BSS 64	828
BD 676	445	BSS 79	832
BD 677	441	BSS 80	836
BD 678	445	BSS 81	832
BD 679	441	BSS 82	836
BD 680	445	BSV 15	840
BD 861	459	BSV 16	840
BD 862	463	BSV 17	840
BD 863	459	BSV 65	848
BD 864	463	BSV 65R	848
BD 865	459	BSX 45	853
BD 866	463	BSX 46	853
BD 875	467	BSX 47	853
BD 876	489	BSX 48	861
BD 877	467	BSX 49	861
BD 878	469	BSX 62	865
BD 879	467	BSX 63	865
BD 880	469		
BD 975	471		
BD 976	475		
BD 977	471		
BD 978	475		
BD 979	471		
BD 980	475		

Application Reference Index

Type	Page	Type	Page
Silicon switching transistors			
BSY 17	870	BF 254	513
BSY 18	870	BF 255	513
BSY 34	877	BF 324	519
BSY 58	877	BF 362	523
BSY 62	870	BF 363	523
BSY 63	870	BF 414	528
		BF 450	536
		BF 451	536
		BF 502	551
Silicon transistors for video stages			
BF 420	530	BF 503	553
BF 421	533	BF 505	555
BF 422	530	BF 506	557
BF 423	533	BF 507	559
BF 457	541	BF 550	561
BF 458	541	BF 554	565
BF 459	541	BF 562	567
BF 469	545	BF 568	569
BF 470	548	BF 569	571
BF 471	545	BF 579	573
BF 472	548	BF 599	575
BF 622	579	BF 606A	577
BF 623	581	BF 660	583
BF 847	587	BF 767	585
BF 848	587	BF 926	600
BF 849	587	BF 939	602
BF 857	590	BF 959	604
BF 858	590	BF 967	624
BF 859	590	BF 968	626
BF 869	594	BF 970	628
BF 870	597	BF 979S	630
BF 871	594	BFS 17	736
BF 872	597	BFS 17R	736
BFN 16	632	BFS 18	739
BFN 17	634	BFS 18R	739
BFN 18	632	BFS 19	739
BFN 19	634	BFS 19R	739
BFN 20	636	BFS 20	741
BFN 21	640	BFS 20R	741
BFN 22	644	BFS 55A	743
BFN 23	648	2N 6619	720
		2N 6620	716
		2N 6621	777
Silicon RF transistors			
BF 198	492		
BF 199	497		
BF 240	501		
BF 241	501		

Type	Page	Type	Page
MOS field effect transistors		BFT 12	747
BF 960	607	BFT 65	751
BF 961	616	BFT 66	754
		BFT 67	754
Junction field effect transistors		BFT 75	759
BF 245A	503	BFT 97	762
BF 245B	503	BFT 98	766
BF 245C	503	BFT 99	766
BF 246A	510	BFW 16A	771
BF 246B	510	BFW 30	774
BF 246C	510	BFW 92	777
BF 256A	516	BFW 93	780
BF 256B	516	BFX 55	783
BF 256C	516	BFX 59	788
BF 410A	525	BFX 59F	788
BF 410B	525	BFX 60	792
BF 410C	525	BFX 89	795
BF 410D	525	BFY 90	798
		Microwave transistors	
Transistors for antenna and broadband amplifier		BFQ 28	662
BFQ 17	655	BFQ 57	673
BFQ 19	659	BFQ 58	680
BFQ 28	662	BFQ 59	684
BFQ 29	669	BFQ 60	689
BFQ 57	673	BFR 14A	694
BFQ 58	680	BFR 14B	703
BFQ 59	684	BFR 14C	708
BFQ 60	689		
BFR 14A	694	Transistors for film circuits	
BFR 14B	703	BCV 26	268
BFR 14C	708	BCV 27	272
BFR 15A	712	BCV 46	268
BFR 34A	716	BCV 47	272
BFR 35A	720		
BFR 35AR	720		
BFR 90	724		
BFR 91	727		
BFR 92	730		
BFR 93	730		
BFR 96	733		
BFS 17	736		
BFS 55A	743		

Application Reference Index

Type	Page	Type	Page
Transistors for film circuits		BFR 93	730
BCW 60	276	BFS 17	736
BCW 61	283	BFS 17R	736
BCW 65	290	BFS 18	739
BCW 66	290	BFS 18R	739
BCW 67	295	BFS 19	739
BCW 68	295	BFS 19R	739
BCX 41	308	BFS 20	741
BCX 42	312	BFS 20R	741
BCX 51	316	BFT 75	759
BCX 52	316	BSS 63	824
BCX 53	316	BSS 64	828
BCX 54	320	BSS 79	832
BCX 55	320	BSS 80	836
BCX 56	320	BSS 81	832
BCX 58	324	BSS 82	836
BCX 59	324	BSV 65	848
BCX 68	330	BSV 65R	848
BCX 69	334	Silicon phototransistors	
BCX 70	276	BP 103	1)
BCX 71	283	BPX 38; BPX 43, BPX 81	
BF 550	561	BPY 61	
BF 554	565	Control unit	
BF 568	569	BZW 20	923
BF 569	571	Unijunction transistor	
BF 579	573	BRY 56	819
BF 599	575	Miniature thyristors	
BF 622	579	BR 103	801
BF 623	581	BR 303	805
BF 660	583	BR 403	807
BF 767	585	BRY 20	809
BFN 16	632	BRY 21	813
BFN 17	634	BRY 55/30	815
BFN 18	632	BRY 55/60	815
BFN 19	634	BRY 55/100	815
BFN 20	636	BRY 55/200	815
BFN 21	640	BRY 55/300	815
BFN 23	648		
BFQ 17	655		
BFQ 19	659		
BFQ 29	669		
BFR 35A	720		
BFR 35AR	720		
BFR 92	730		

1) Refer to Data Book "Optoelectronic Semiconductors"

1.2. Index of Types in Alphanumerical Order

Index of Types in Alphanumerical Order

Type	Collector reverse voltage $V_{CB0}; V$ (V_{CES}); V	Collector current $I_C; mA$ (I_{CM}) mA	Cutoff frequency $f_T; MHz$	Thermal resistance $R_{thJA}; K/W$ ($R_{thJC}; K/W$)	Case JEDEC designation	Page
■ AC121 P	-20	-300	1,5	≤ 300 (50)	sim. to TO-1	75
■ AC151 P	-32	-200	1,5	≤ 300 (50)	sim. to TO-1	81
■ AC151r P	-32	-200	1,5	≤ 300 (50)	sim. to TO-1	81
■ AC152 P	-32	-500	1,5	≤ 300 (50)	sim. to TO-1	75
■ ACY23 P	-32	-200	1,5	≤ 300	sim. to TO-1	87
■ ACY32 P	-32	-200	1,5	≤ 300	sim. to TO-1	87
AF106 P	-25	-10	220	≤ 750 (400)	TO-72	93
AF109R P	-20	-10	280	≤ 750 (400)	TO-72	99
AF139 P	-20	-10	550	≤ 750 (400)	TO-72	104
AF239 P	-(20)	-10	700	≤ 750 (400)	TO-72	112
AF239S P	-(20)	-10	780	≤ 750 (400)	TO-72	118
AF240 P	-(20)	-10	500	≤ 750 (400)	TO-72	122
AF279S P	-(20)	-10	820	≤ 600	sim. to TO-119	125
AF280S P	-(20)	-10	550	≤ 600	sim. to TO-119	127
AF289 P	-20	-10	750	≤ 600	sim. to TO-119	129
AF379 P	-20	-20	1250	(≤ 450)	sim. to TO-119	131
■ ASY48 P	-64	-300	1,2	≤ 300	sim. to TO-1	133
■ ASY70 P	-32	-300	1,5	≤ 300	sim. to TO-1	133
BC107 N	(50)	(200)	250	≤ 500	TO-18	135
BC108 N	(30)	(200)	250	≤ 500	TO-18	135
BC109 N	(30)	50	300	≤ 500	TO-18	135
BC121 N	5	75	250	≤ 1000	U 32	143
BC122 N	30	75	250	≤ 1000	U 32	143
BC123 N	45	75	250	≤ 1000	U 32	143
BC140 N	80	1000	> 50	≤ 200	TO-39	150
BC141 N	100	1000	> 50	≤ 200	TO-39	150

■ Not for new design

1) V_{CER}

Type	Collector reverse voltage $V_{CB0}; V_{CES}; V$	Collector current $I_C; mA$ $(I_{CM}) mA$	Cutoff frequency $f_T; MHz$	Thermal resistance $R_{thJA}; K/W$	Case JEDEC designation	Page
(P = PNP) (N = NPN)						
BC160 P	-40	-1000	> 50	≤ 200	TO-39	154
BC161 P	-60	-1000	> 50	≤ 200	TO-39	154
BC167 N	(50)	(200)	250	≤ 420	TO-92	158
BC168 N	(30)	(200)	250	≤ 420	TO-92	158
BC169 N	(30)	50	300	≤ 420	TO-92	158
BC177 P	(-50)	-100	130	≤ 500	TO-18	161
BC178 P	(-30)	-100	130	≤ 500	TO-18	161
BC179 P	(-25)	-50	130	≤ 500	TO-18	161
BC182 N	60	200	> 150	≤ 420	TO-92	169
BC183 N	45	200	> 150	≤ 420	TO-92	169
BC201 P	- 5	-75	80	≤ 1000	U-32	172
BC202 P	-30	-75	80	≤ 1000	U-32	172
BC203 P	-45	-75	80	≤ 1000	U-32	172
BC212 P	-60	-200	> 200	≤ 420	TO-92	180
BC213 P	-45	-200	> 200	≤ 420	TO-92	180
BC237 N	50)	(200)	250	≤ 420	TO-92	183
BC238 N	30)	(200)	250	≤ 420	TO-92	183
BC239 N	30)	50	300	≤ 420	TO-92	183
BC257 P	(-50)	-(200)	130	≤ 420	TO-92	191
BC258 P	(-30)	-(200)	130	≤ 420	TO-92	191
BC259 P	(-25)	-50	130	≤ 420	TO-92	191
BC307 P	(-50)	-(200)	200	≤ 420	TO-92	194
BC308 P	(-30)	-(200)	200	≤ 420	TO-92	194
BC309 P	(-25)	-50	200	≤ 420	TO-92	194
BC327 P	(-50)	-800	100	≤ 200	TO-92	202
BC328 P	(-30)	-800	100	≤ 200	TO-92	202
BC337 N	(50)	800	100	≤ 200	TO-92	206
BC338 N	(30)	800	100	≤ 200	TO-92	206
BC368 N	(25)	1000	65	≤ 156	TO-92	210
BC369 P	(-25)	-1000	65	≤ 156	TO-92	213
BC413 N	45	100	250	≤ 420	TO-92	216
BC414 N	50	100	250	≤ 420	TO-92	216

Index of Types in Alphanumerical Order

Type	Collector reverse voltage $V_{CB0}; V_{(V_{CES})}$ V	Collector current $I_C; \text{mA}$	Cutoff frequency $f_T; \text{MHz}$	Thermal resistance $R_{thJA}; \text{K/W}$	Case JEDEC designation	Page
BC415 P	-45	-100	200	≤ 400	TO-92	223
BC416 P	-50	-100	200	≤ 400	TO-92	223
BC516 ¹⁾ P	-40	-400	220	≤ 200	TO-92	230
BC517 ¹⁾ N	40	400	220	≤ 200	TO-92	233
BC546 N	80	100	300	≤ 250	TO-92	236
BC547 N	50	100	300	≤ 250	TO-92	236
BC548 N	30	100	300	≤ 250	TO-92	236
BC549 N	30	100	300	≤ 250	TO-92	236
BC550 N	50	100	300	≤ 250	TO-92	236
BC556 P	-80	-100	150	≤ 250	TO-92	242
BC557 P	-50	-100	150	≤ 250	TO-92	242
BC558 P	-30	-100	150	≤ 250	TO-92	242
BC559 P	-30	-100	300	≤ 250	TO-92	242
BC560 P	-50	-100	300	≤ 250	TO-92	242
BC617 ¹⁾ N	50	1000	150	≤ 200	TO-92	248
BC618 ¹⁾ N	80	1000	150	≤ 200	TO-92	248
BC635 N	(45)	1000	130	≤ 156	TO-92	252
BC636 P	(-45)	-1000	130	≤ 156	TO-92	256
BC637 N	(60)	1000	130	≤ 156	TO-92	252
BC638 P	(-60)	-1000	130	≤ 156	TO-92	256
BC639 N	(100)	1000	130	≤ 156	TO-92	252
BC640 P	(-100)	-1000	130	≤ 156	TO-92	256
BC875 ¹⁾ N	60	1000	200	≤ 156	TO-92	260
BC876 ¹⁾ P	-60	-1000	200	≤ 156	TO-92	264
BC877 ¹⁾ N	80	1000	200	≤ 156	TO-92	260
BC878 ¹⁾ P	-80	-1000	200	≤ 156	TO-92	264
BC879 ¹⁾ N	100	1000	200	≤ 156	TO-92	260
BC880 ¹⁾ P	-100	-1000	200	≤ 156	TO-92	264

1) Darlington transistors

Type		Collector reverse voltage $V_{CB0}; V_{(V_{CE0})}; V$	Collector current $I_C; mA$	Cutoff frequency $f_T; MHz$	Thermal resistance $R_{thJA}; K/W$ (R_{thJSB}) K/W	Case JEDEC designation	Page
(P = PNP) (N = NPN)							
BCV26	P	- 40	-500	200	≤ 358	TO-236	268
BCV27	N	40	500	200	≤ 358	TO-236	268
BCV46	P	- 80	-500	200	≤ 358	TO-236	272
BCV47	N	80	500	200	≤ 358	TO-236	272
BCW60	N	(32)	200	250	≤ 450	TO-236	276
BCW60F	N	(32)	200	250	≤ 450	TO-236	276
BCW60R	N	(32)	200	250	≤ 450	TO-236	276
BCW61	P	(- 32)	-200	180	≤ 450	TO-236	283
BCW61F	P	(- 32)	-200	180	≤ 450	TO-236	283
BCW61R	P	(- 32)	-200	180	≤ 450	TO-236	283
BCW65	N	(32)	800	100	≤ 375	TO-236	290
BCW65R	N	(32)	800	100	≤ 375	TO-236	290
BCW66	N	(45)	800	100	≤ 375	TO-236	290
BCW66R	N	(45)	800	100	≤ 375	TO-236	290
BCW67	P	(- 32)	-800	100	≤ 375	TO-236	295
BCW67R	P	(- 32)	-800	100	≤ 375	TO-236	295
BCW68	P	(- 45)	-800	100	≤ 375	TO-236	295
BCW68R	P	(- 45)	-800	100	≤ 375	TO-236	295
BCX22	N	(125)	800	100	≤ 390	TO-18	300
BCX23	P	(-125)	-800	100	≤ 390	TO-18	304
BCX24	N	(100)	800	100	≤ 390	TO-18	300
BCX39	P	(-100)	-800	100	≤ 390	TO-18	304
BCX41	N	125	800	100	≤ 380	TO-236	308
BCX41R	N	125	800	100	≤ 380	TO-236	308
BCX42	P	-125	-800	100	≤ 380	TO-236	312
BCX42R	P	-125	-800	100	≤ 380	TO-236	312
BCX51	P	- 45	-1000	50	(≤ 30)	SOT-89	316
BCX52	P	- 60	-1000	50	(≤ 30)	SOT-89	316
BCX53	P	-100	-1000	50	(≤ 30)	SOT-89	316

Index of Types in Alphanumerical Order

Type		Collector reverse voltage $V_{CBO}; V_{(V_{CEO})}; V$	Collector current $I_C; (mA)$	Cutoff frequency $f_T; (MHz)$	Thermal resistance $R_{thJA}; K/W$ $(R_{thJSB}) K/W$	Case JEDEC designation	Page
(P = PNP) (N = NPN)							
BCX54	N	45	1000	50	(≤ 30)	SOT-89	320
BCX55	N	60	1000	50	(≤ 30)	SOT-89	320
BCX56	N	100	1000	50	(≤ 30)	SOT-89	320
BCX58	N	(32)	100	250	≤ 280	TO-92	324
BCX59	N	(45)	100	250	≤ 280	TO-92	324
BCX68	N	(20)	1000	65	(≤ 30)	SOT-89	330
BCX69	P	(-20)	-1000	65	(≤ 30)	SOT-89	334
BCX70	N	(45)	200	250	≤ 450	TO-236	276
BCX70R	N	(45)	200	250	≤ 450	TO-236	276
BCX71	P	-45	- 200	180	≤ 450	TO-236	283
BCX71R	P	-45	- 200	180	≤ 450	TO-236	283
BCX73	N	(32)	800	> 100	≤ 200	TO-92	338
BCX74	N	(45)	800	> 100	≤ 200	TO-92	338
BCX75	P	-32	- 800	> 100	≤ 200	TO-92	342
BCX76	P	-45)	- 800	> 100	≤ 200	TO-92	342
BCX78	P	-32	- 100	> 200	≤ 280	TO-92	346
BCX79	P	-45	- 100	> 200	≤ 280	TO-92	346
BCX94	N	(100)	800	100	≤ 390	TO-18	300
BCY58	N	(32)	200	250	≤ 450	TO-18	352
BCY59	N	(45)	200	250	≤ 450	TO-18	352
BCY65E	N	(60)	100	250	≤ 450	TO-18	352
BCY66	N	(45)	50	250	≤ 450	TO-18	358
BCY67	P	(-45)	- 50	180	≤ 450	TO-18	365
BCY77	P	(-60)	- 100	180	≤ 450	TO-18	371
BCY78	P	(-32)	- 200	180	≤ 450	TO-18	371
BCY79	P	(-45)	- 200	180	≤ 450	TO-18	371

Type		Collector reverse voltage $V_{CBO}; V$ ($V_{CEO}; V$)	Collector current $I_C; (A)$	Cutoff frequency $f_T; MHz$	Thermal resistance $R_{thJA}; K/W$ ($R_{thJC}; K/W$)	Case JEDEC designation	Page
(P = PNP) (N = NPN)							
BD135	N	45	1,5	> 50	≤ 110	TO-126	378
BD136	P	- 45	-1,5	> 75	≤ 110	TO-126	383
BD137	N	60	1,5	> 50	≤ 110	TO-126	378
BD138	P	- 60	-1,5	> 75	≤ 110	TO-126	383
BD139	N	(80)	1,5	> 50	≤ 110	TO-126	378
BD140	P	(- 80)	-1,5	> 75	≤ 110	TO-126	383
BD287	P	- 30	-12	> 50	≤ 100	TO-126	388
BD288	P	- 45	-12	> 50	≤ 100	TO-126	388
BD329	N	(20)	3	130	≤ 100	TO-126	392
BD330	P	(- 20)	-3	100	≤ 100	TO-126	395
BD424	N	(100)	0,8	100	≤ 70	sim.toTO-202	398
BD429	N	(20)	3	130	≤ 62,5	sim.toTO-202	401
BD430	P	(- 32)	-3	100	≤ 62,5	sim.toTO-202	405
BD433	N	22	4	> 3	≤ 100	TO-126	409
BD434	P	- 22	-4	> 3	≤ 100	TO-126	414
BD435	N	32	4	> 3	≤ 100	TO-126	409
BD436	P	- 32	-4	> 3	≤ 100	TO-126	414
BD437	N	45	4	> 3	≤ 100	TO-126	409
BD438	P	- 45	-4	> 3	≤ 100	TO-126	414
BD439	N	60	4	> 3	≤ 100	TO-126	409
BD440	P	- 60	-4	> 3	≤ 100	TO-126	414
BD441	N	80	4	> 3	≤ 100	TO-126	409
BD442	P	- 80	-4	> 3	≤ 100	TO-126	414
BD487	P	- 30	-12	> 50	(≤ 10)	TO-202	419
BD488	P	- 45	-12	> 50	(≤ 10)	TO-202	419
BD524	N	(100)	0,8	100	≤ 110	TO-126	423

Index of Types in Alphanumerical Order

Type		Collector reverse voltage V_{CB0} ; V (V_{CE0}); V	Collector current I_C ; mA (A)	Cutoff frequency f_T ; MHz	Thermal resistance R_{thJA} ; K/W (R_{thJC}); K/W	Case JEDEC designation	Page
BD611	N	22	4	> 3	≤ 62,5	TO-202	425
BD612	P	-22	-4	> 3	≤ 62,5	TO-202	429
BD613	N	32	4	> 3	≤ 62,5	TO-202	425
BD614	P	-32	-4	> 3	≤ 62,5	TO-202	429
BD615	N	45	4	> 3	≤ 62,5	TO-202	425
BD616	P	-45	-4	> 3	≤ 62,5	TO-202	429
BD617	N	60	4	> 3	≤ 62,5	TO-202	425
BD618	P	-60	-4	> 3	≤ 62,5	TO-202	429
BD619	N	80	4	> 3	≤ 62,5	TO-202	425
BD620	P	-80	-4	> 3	≤ 62,5	TO-202	429
BD643 ¹⁾	N	45	8	> 1	< 80	TO-220	433
BD644 ¹⁾	P	-45	-(8)	> 1	< 80	TO-220	437
BD645 ¹⁾	N	60	(8)	> 1	< 80	TO-220	433
BD646 ¹⁾	P	-60	-(8)	> 1	< 80	TO-220	437
BD647 ¹⁾	N	80	(8)	> 1	< 80	TO-220	433
BD648 ¹⁾	P	-80	-(8)	> 1	< 80	TO-220	437
BD649 ¹⁾	N	100	(8)	> 1	< 80	TO-220	433
BD650 ¹⁾	P	-100	-(8)	> 1	< 80	TO-220	437
BD675 ¹⁾	N	45	4	> 1	3,12	TO-126	441
BD676 ¹⁾	P	-45	-4	> 1	3,12	TO-126	445
BD677 ¹⁾	N	60	4	> 1	3,12	TO-126	441
BD678 ¹⁾	P	-60	-4	> 1	3,12	TO-126	445
BD679 ¹⁾	N	80	4	> 1	3,12	TO-126	441
BD680 ¹⁾	P	-80	-4	> 1	3,12	TO-126	445
BD825	N	45	1,5	> 50	(15)	TO-202	449
BD826	P	-45	-1,5	> 50	(15)	TO-202	454
BD827	N	60	1,5	> 50	(15)	TO-202	449
BD828	P	-60	-1,5	> 50	(15)	TO-202	454
BD829	N	(80)	1,5	> 50	(15)	TO-202	449
BD830	P	(-80)	-1,5	> 50	(15)	TO-202	454

1) Darlington transistors

Type (P = PNP) (N = NPN)	Collector reverse voltage $V_{CB0}; V$ (V_{CES}); V	Collector current I_C ; (A)	Cutoff frequency f_T ; MHz	Thermal resistance $R_{thJA}; K/W$ ($R_{thJC}; K/W$)	Case JEDEC designation	Page
BD861 ¹⁾	N 45	4	> 1	(8,3)	TO-202	459
BD862 ¹⁾	P - 45	-4	> 1	(8,3)	TO-202	463
BD863 ¹⁾	N 60	4	> 1	(8,3)	TO-202	459
BD864 ¹⁾	P - 60	-4	> 1	(8,3)	TO-202	463
BD865 ¹⁾	N 80	4	> 1	(8,3)	TO-202	459
BD866 ¹⁾	P - 80	-4	> 1	(8,3)	TO-202	463
BD875 ¹⁾	N 60	1	200	< 100	TO-126	467
BD876 ¹⁾	P - 60	-1	200	< 100	TO-126	469
BD877 ¹⁾	N 80	1	200	< 100	TO-126	467
BD878 ¹⁾	P - 80	-1	200	< 100	TO-126	469
BD879 ¹⁾	N 80	1	200	< 100	TO-126	467
BD880 ¹⁾	P -100	-1	200	< 100	TO-126	469
BD975 ¹⁾	N 60	1	200	78	TO-202	471
BD976 ¹⁾	P - 60	-1	200	78	TO-202	475
BD977 ¹⁾	N 80	1	200	78	TO-202	471
BD978 ¹⁾	P - 80	-1	200	78	TO-202	475
BD979 ¹⁾	N 100	1	200	78	TO-202	471
BD980 ¹⁾	P -100	-1	200	78	TO-202	475
BDW25	N 130	3	30	≤ 85	SOT-9	479
BDX27	P - 40	-5	50	≤ 85	SOT-9	486
BDX28	P - 60	-5	50	≤ 85	SOT-9	486

1) Darlington transistors

Index of Types in Alphanumerical Order

Type		Collector reverse voltage $V_{CBO}; V$ ($\pm V_{DS}$); V	Collector current $I_C; mA$ [I_{DSS}] mA	Cutoff frequency $f_T; MHz$	Thermal resistance $R_{thJA}; K/W$ ($R_{thJC} K/W$)	Case JEDEC designation	Page
BDX29	P	-80	-5000	50	$\leq (3,5)$	SOT-9	486
BDX30	P	-125	-5000	50	$\leq (3,5)$	SOT-9	486
BDY12	N	40 [V_{CE0}]	3000	70 (>30)	$\leq (5)$	SOT-9	479
BDY13	N	60 [V_{CE0}]	3000	70 (>30)	$\leq (5)$	SOT-9	479
BF198	N	40	25	400	≤ 250	TO-92	492
BF199	N	40	25	550	≤ 250	TO-92	497
BF240	N	40	25	400	≤ 420	TO-92	501
BF241	N	40	25	400	≤ 420	TO-92	501
BF245A	N	(30)	[2 to 6,5]	¹⁾	≤ 250	sim. to TO-92	503
BF245B	N	(30)	[6 to 15]	¹⁾	≤ 250	sim. to TO-92	503
BF245C	N	(30)	[12 to 25]	¹⁾	≤ 250	sim. to TO-92	503
BF246A	N	(25)	[30 to 80]	¹⁾	≤ 250	TO-92	510
BF246B	N	(25)	[60 to 140]	¹⁾	≤ 250	TO-92	510
BF246C	N	(25)	[110 to 250]	¹⁾	≤ 250	TO-92	510
BF254	N	30	30	260	≤ 450	TO-92	513
BF255	N	30	30	200	≤ 450	TO-92	513
BF256A	N	(30)	[3 to 7]	¹⁾	≤ 250	sim. to TO-92	516
BF256B	N	(30)	[6 to 13]	¹⁾	≤ 250	sim. to TO-92	516
BF256C	N	(30)	[11 to 18]	¹⁾	≤ 250	sim. to TO-92	516
BF324	P	-30	-25	350	≤ 420	TO-92	519
BF362	N	20	20	800	≤ 580	sim. to TO-119	523
BF363	N	20	20	800	≤ 580	sim. to TO-119	523
BF410A	N	(20)	[0,7 to 3]	¹⁾	≤ 250	sim. to TO-92	525
BF410B	N	(20)	[2,5 to 7]	¹⁾	≤ 250	sim. to TO-92	525
BF410C	N	(20)	[6 to 12]	¹⁾	≤ 250	sim. to TO-92	525
BF410D	N	(20)	[10 to 18]	¹⁾	≤ 250	sim. to TO-92	525
BF414	P	-40	-25	560	≤ 350	TO-92	528
BF420	N	300	25	≤ 60	≤ 150	TO-92	530
BF421	P	-300	-25	≤ 60	≤ 150	TO-92	533
BF422	N	250	25	≤ 60	≤ 150	TO-92	530
BF423	P	-250	-25	≥ 60	≤ 150	TO-92	533
BF450	P	-40	-25	325	≤ 660	TO-92	536
BF451	P	-40	-25	325	≤ 660	TO-92	536
BF457	N	160	100	90	≥ 104	TO-126	541
BF458	N	250	100	90	≤ 104	TO-126	541
BF459	N	300	100	90	≤ 104	TO-126	541
BF469	N	250	30	≥ 60	≤ 100	TO-126	545

1) N channel junction field effect transistors

Type (P = PNP) (N = NPN)		Collector reverse voltage V_{CBO} ; V	Collector current I_C ; mA	Cutoff frequency f_T ; MHz	Thermal resistance R_{thJA} ; K/W	Case JEDEC designation	Page
BF470	P	-250	-30	≥ 60	≤ 100	TO-126	548
BF471	N	300	30	≥ 60	≤ 100	TO-126	545
BF472	P	-300	-30	≥ 60	≤ 100	TO-126	548
BF502	N	40	20	700	≤ 250	TO-92	551
BF503	N	40	20	750	≤ 250	TO-92	553
BF505	N	30	20	≥ 750	≤ 250	TO-92	555
BF506	P	- 40	-30	550	≤ 350	TO-92	557
BF507	N	30	20	≥ 750	≤ 250	TO-92	559
BF550	P	- 40	-25	375	≤ 500	TO-236	561
BF554	N	30	30	260	≤ 500	TO-236	565
BF562	N	30	20	600	≤ 420	TO-92	567
BF568	P	- 40	-30	1100	≤ 500	TO-236	569
BF569	P	- 40	-30	850	≤ 500	TO-236	571
BF579	P	- 20	-30	1600	≤ 500	TO-236	573
BF599	N	40	25	550	≤ 500	TO-236	575
BF606A	P	- 40	-25	650	≤ 350	TO-92	577
BF622	N	250	20	>60	$\leq 45^1)$	SOT-89	579
BF623	P	-250	-20	>60	$\leq 45^1)$	SOT-89	581
BF660	P	- 40	-25	650	≤ 500	TO-236	583
BF767	P	- 30	-20	950	≤ 500	TO-236	585
BF 847	P	-160	-100	90	≤ 70	TO-202	587
BF 848	P	-270	-100	90	≤ 70	TO-202	587
BF 849	P	-300	-100	90	≤ 70	TO-202	587
BF857	N	160	100	90	≤ 70	TO-202	590
BF858	N	270	100	90	≤ 70	TO-202	590
BF859	N	300	100	90	≤ 70	TO-202	590
BF869	N	250	30	≥ 60	≤ 70	TO-202	594
BF870	P	-250	-30	≥ 60	≤ 70	TO-202	597
BF871	N	300	30	≥ 60	≤ 70	TO-202	594
BF872	P	-300	-30	≥ 60	≤ 70	TO-202	597
BF926	P	- 40	-25	600	≤ 350	TO-92	600

1) R_{thJSB}

Index of Types in Alphanumerical Order

Type	Collector reverse voltage $V_{CB0}; V_{CER}; V$	Collector current $I_C; \text{mA}$	Cutoff frequency $f; \text{MHz}$	Thermal resistance $R_{thJA}; K/W$ $(R_{thJB}) K/W$	Case JEDEC designation	Page
BF939	P - 30	- 20	750	≤ 500	TO-92	602
BF959	N 30	30	1100	< 250	TO-92	604
BF960 ¹⁾	N 30 ³⁾	30 ⁴⁾	-	≤ 450	sim.toTO-120	607
BF961 ¹⁾	N 30 ³⁾	30 ⁴⁾	-	≤ 600	sim.toTO-120	616
BF967	P - 30	- 20	950	≤ 600	sim.toTO-119	624
BF968	P - 40	- 30	1100	≤ 600	sim.toTO-119	626
BF970	P - 40	- 30	850	≤ 600	sim.toTO-119	628
BF979S	P - 30 ⁵⁾	- 50	1600	≤ 600	sim.toTO-119	630
BFN16	N 250	200	> 60	≤ 45	SOT-89	632
BFN17	P 250	-200	> 60	≤ 45	SOT-89	634
BFN18	N 300	200	> 60	≤ 45	SOT-89	632
BFN19	P 300	-200	> 60	≤ 45	SOT-89	634
BFN20	N 300	20	> 60	(≤ 45)	SOT-89	636
BFN21	P -300	- 20	> 60	(≤ 45)	SOT-89	640
BFN22	N 250	25	≥ 60	≤ 450	TO-236	644
BFN23	P -250	- 25	≥ 60	≤ 450	TO-236	648
BFP22	N 200	500	> 50	≤ 200	TO-92	651
BFP23	P -200	-500	> 50	≤ 200	TO-92	653
BFQ17	N 40	150	1200	(≤ 60)	SOT-89	655
● BFQ19	N 20	75	5000	(≤ 90)	SOT-89	659
● BFQ28	N 20	15	5000	≤ 250	K.BG.100-Mil.	662
● BFQ29	N 20	30	4000	≤ 400	TO-236	669
● BFQ57	N 25	35	6500	250	K.BG.100-Mil.	673
● BFQ58	N 25	30	6500	250	K.BG.100-Mil.	680
● BFQ59	N 27	35	4000	(≤ 70)	K.BG.200-Mil.	684
● BFQ60	N 27	35	4000	≤ 250	K.BG.100-Mil.	689
● BFR14A	N 20	30	5000	≤ 250	K.BG.140-Mil.	694
● BFR14B	N 20	30	6000	≤ 250	K.BG.100-Mil.	703
● BFR14C	N 27	35	4300	≤ 70 ²⁾	K.BG.200-Mil.	708

1) MOS field effect transistor

2) R_{thJC}

3) V_{DS}

4) I_D

5) V_{CBS}

●) Subject to export licensing

Type	Collector reverse voltage V_{CB0} ; V (V_{CER}); V	Collector current I_C ; mA	Cutoff frequency f ; MHz	Thermal resistance R_{thJA} ; K/W (R_{thJC}); K/W	Case JEDEC designation	Page
(P=PNP) (N=NPN)						
BFR15A	N (20)	30	4500	≤ 700	TO-72	712
BFR34A	N (20)	30	5000	≤ 500	sim.toTO-119	716
BFR35A	N (20)	30	5000	≤ 500	TO-236	720
BFR35AR	N (20)	30	5000	≤ 500	TO-236	720
● BFR90	N (20)	30	5000	≤ 500	sim.toTO-119	724
● BFR91	N (20)	50	5000	≤ 400	sim.toTO-119	727
● BFR92	N (20)	30	5000	≤ 500	TO-236	730
● BFR93	N (20)	50	4500	≤ 500	TO-236	730
● BFR96	N 20	90	5000	≤ 200	sim. to TO-119	733
BFS17	N 25	25	1300	≤ 500	TO-236	736
BFS17R	N 25	25	1300	≤ 500	TO-236	736
BFS18	N 30	30	200	≤ 520	TO-236	739
BFS18R	N 30	30	200	≤ 520	TO-236	739
BFS19	N 30	30	260	≤ 520	TO-236	739
BFS19R	N 30	30	260	≤ 520	TO-236	739
BFS20	N 30	25	450	≤ 520	TO-236	741
BFS20R	N 30	25	450	≤ 520	TO-236	741
● BFS55A	N (20)	50	4500	≤ 700	TO-72	743
BFT12	N 25	150	1900	≤ 120	sim. to TO-119	747
● BFT65	N (20)	50	5000	≤ 700	sim. to TO-119	751
● BFT66	N 20	30	4000	≤ 700	TO-72	754
● BFT67	N 20	30	4000	≤ 700	TO-72	754
● BFT75	N 20	50	5000	≤ 500	TO-236	759
● BFT97	N 20	30	4000	<400	sim.toTO-119	762
● BFT98	N (20) ¹⁾	200	3000	(< 35)	sim.toTO-117	766
● BFT99	N (20) ¹⁾	350	3000	(< 35)	sim.toTO-117	766
BFW16A	N 40	150	1200	≤ 250	TO-39	771
■ BFW30	N 20	50	1600	≤ 700	TO-72	774
BFW92	N 25	25	1900	400	sim.toTO-119	777
■ BFW93	N 18	50	1600	≤ 400	sim.toTO-119	780

■ Not for new design
● Subject to export licensing

1) V_{CES}

Index of Types in Alphanumerical Order

Type	Collector reverse voltage $V_{CB0}; V_{CES}; V$	Collector current $I_C; \text{mA}$	Cutoff frequency $f; \text{MHz}$	Thermal resistance $R_{thJA}; \text{K/W}$	Case JEDEC designation	Page
(P=PNP) (N=NPN)						
BFX55	N 60	400	700	≤ 220	TO-39	783
BFX59	N 30	100	1000	≤ 650	TO-72	788
BFX59F	N 30	100	1050	≤ 650	TO-72	788
■ BFX60	N 40	25	550	≤ 650	TO-72	792
BFX89	N 30	25	1200	≤ 700	TO-72	795
BFY90	N 30	25	1200	≤ 700	TO-72	798
BR103 ⁴⁾	P -30 ⁴⁾	- 6 ⁸⁾	-	-	TO-92	801
BR303 ⁴⁾	P -30 ⁵⁾	-800 ⁶⁾	25	≤ 100	TO-126	805
BR403 ⁴⁾	P -30 ⁵⁾	-800 ⁶⁾	25	≤ 125	sim.to TO-202	807
BRY20 ⁴⁾	40 ⁵⁾	500 ⁶⁾	-	≤ 220	TO-12	809
BRY21 ⁴⁾	80 ⁵⁾	500 ⁶⁾	-	≤ 220	TO-12	813
BRY55/30 ⁴⁾	30 ⁷⁾	8000 ²⁾	-	≤ 230	TO-92	815
BRY55/60 ⁴⁾	60 ⁷⁾	8000 ⁸⁾	-	≤ 230	TO-92	815
BRY55/100 ⁴⁾	100 ⁷⁾	8000 ⁸⁾	-	≤ 230	TO-92	815
BRY55/200 ⁴⁾	200 ⁷⁾	8000 ⁸⁾	-	≤ 230	TO-92	815
BRY55/300 ⁴⁾	300 ⁷⁾	8000 ⁸⁾	-	≤ 230	TO-92	815
BRY56 ¹⁾	N 70 ²⁾	175 ³⁾	-	≤ 250	TO-92	819
BSS63	P -110	-100	> 50	≤ 620	TO-236	824
BSS64	N 120	100	> 50	≤ 620	TO-236	828
BSS79	N 75	800	250	≤ 360	TO-236	832
BSS80	P -60	-800	200	≤ 360	TO-236	836
BSS81	N 75	800	250	<360	TO-236	832
BSS82	P -60	-800	200	≤ 360	TO-236	836
BSV15	P (-40)	-1000	50	≤ 200	TO-39	840

1) Programmable unijunction transistor

2) V_{GA} = Voltage, gate terminal: anode

3) I_A = Anode current

■ Not for new design

4) Miniature thyristor

5) $-V_R$ = Negative reverse voltage

6) I_F = Forward current

7) Repetitive peak reverse voltage

8) Surge current

Type		Collector reverse voltage V_{CB0} ; V (V_{CES}); V	Collector current I_C ; mA (A)	Cutoff frequency f_T ; MHz	Thermal resistance R_{thJA} ; K/W (R_{thJC}); K/W	Case JEDEC designation	Page
(P = PNP) (N = NPN)							
BSV16	P	-(60)	-(1)	> 50	≤ 200	TO-39	840
BSV17	P	-(80)	-(1)	> 50	≤ 200	TO-39	840
BSV65	N	20	150	> 280	≤ 450	TO-236	848
BSV65R	N	20	150	> 280	≤ 450	TO-236	848
BSX45	N	(40)	(1)	> 50	≤ 200	TO-39	853
BSX46	N	(60)	(1)	> 50	≤ 200	TO-39	853
BSX47	N	(80)	(1)	> 50	≤ 200	TO-39	853
BSX48	N	50	600	400	≤ 500	TO-18	861
BSX49	N	60	600	400	≤ 500	TO-18	861
BSX62	N	(40)	(3)	70	≤ 200	TO-39	865
BSX63	N	(50)	(3)	70	≤ 200	TO-39	865
BSY17	N	20	200	> 280	≤ 500	TO-18	870
BSY18	N	20	200	> 280	≤ 500	TO-18	870
BSY34	N	60	600	400	≤ 220	TO-39	877
BSY58	N	50	600	400	≤ 220	TO-39	877
BSY62	N	25	200	> 200	≤ 500	TO-18	870
BSY63	N	40	200	> 300	≤ 500	TO-18	870
BU205	N	(1500)	(2,5)	7,5	(≤ 2,5)	TO-3	884
BU208	N	(1500) ⁴⁾	(5)	1	(≤ 1,6)	TO-3	886
BU208A	N	(1500) ⁴⁾	(5)	7	(≤ 1,6)	TO-3	886
BU326A	N	(900)	(6)	6	(≤ 2)	TO-3	890
BU426	N	(800) ⁴⁾	(6)	6	(≤ 1,1)	SOT-93	893
BU426A	N	(900) ⁴⁾	(6)	6	(≤ 1,1)	SOT-93	893
BU626A	N	1000 ⁵⁾	(10)	6	(≤ 1,5)	TO-3	896
BUW70	N	150	(10)	6	(≤ 1,5)	TO-3	898
BUW71	N	450	(5)	6	(≤ 1,25)	TO-3	898
BUW72	N	450	(10)	6	(≤ 1,25)	TO-3	898
BUX28	N	350 ²⁾	(8)	6	(≤ 1,2)	TO-3	900
BUX80	N	(800)	(10)	6	(≤ 1,1)	TO-3	903
BUX81	N	(1000)	(10)	6	(≤ 1,1)	TO-3	903
BUX82	N	(800)	(6)	6	(≤ 1,65)	TO-3	908
BUX83	N	(1000)	(6)	6	(≤ 1,65)	TO-3	908
BUX84	N	(800)	(2)	20	(≤ 2,5)	TO-220	913
BUX85	N	(1000)	(2)	20	(≤ 2,5)	TO-220	913
BUX86	N	(800)	(0,5)	20	(≤ 4,5)	TO-126	918
BUX87	N	(1000)	(0,5)	20	(≤ 4,5)	TO-126	918
BZW20 ¹⁾	N	20 ²⁾	100	-	≤ 450	TO-236	923

1) Control unit, mark: "TZ"

2) V_{CE0}

4) V_{CESM}

5) V_{CBS}

Index of Types in Alphanumerical Order

Type		Collector reverse voltage $V_{CB0}; V_{(V_{COB})}; V_{(V_{CEO})}$ V	Collector current $I_C; \text{mA}$	Cutoff frequency $f_T; \text{MHz}$	Thermal resistance $R_{thJA}; \text{K/W}$	Case JEDEC designation	Page
2N2218	N	60	800	≥ 250	<188	TO-39	926
2N2218A	N	75	800	≥ 250	<188	TO-39	926
2N2219	N	60	800	≥ 250	<188	TO-39	926
2N2219A	N	75	800	≥ 300	<188	TO-39	926
2N2220	N	60	800	> 250	<300	TO-18	932
2N2221	N	60	800	> 250	<300	TO-18	932
2N2221A	N	75	800	> 250	<300	TO-18	934
2N2222	N	60	800	> 250	<300	TO-18	932
2N2222A	N	75	800	> 250	<300	TO-18	934
2N2904	P	[-40]	-600	≥ 200	<292	TO-39	938
2N2904A	P	[-60]	-600	≥ 200	<292	TO-39	940
2N2905	P	[-40]	-600	≥ 200	<292	TO-39	938
2N2905A	P	[-60]	-600	≥ 200	<292	TO-39	940
2N2906	P	[-40]	-600	> 200	<438	TO-18	945
2N2906A	P	[-40]	-600	> 200	<438	TO-18	947
2N2907	P	[-60]	-600	> 200	<438	TO-18	945
2N2907A	P	[-60]	-600	> 200	<438	TO-18	947
2N3019	N	140	1000	≥ 100	<218	TO-39	952
2N3055	N	100	15000	$\geq 0,8$	< $\leq 1,5^{1)}$	TO-3	957
2N4033	P	-80	-1000	≥ 150	<220	TO-39	961
● 2N6619	N	(20)	30	5000	<500	TO-236	720
● 2N6620	N	(20)	30	5000	<500	sim.to TO-119	716
2N6621	N	25	25	1900	<400	sim.to TO-119	777

●) Subject to export licensing

2. Introduction

2. Introduction

2.1. Designation Code for Semiconductors

1. For types mainly used in radio or television sets and magnetic recorders the type designation code consists of

2 letters and 3 numerals

2. For types mainly used for other applications than those mentioned in section 1 i.e. primarily for commercial purposes, the type designation code consists of

3 letters and 2 numerals

The meaning of letters is as follows:

First letter

- A Base material germanium (material with a band gap of 0.6 to 1.0 eV)
- B Base material silicon (material with a band gap of 1.0 to 1.3 eV)
- C III-V-material, e.g. gallium arsenide (material with a band gap of 1.3 eV and more)
- R Semiconductor material for photo-conductive cells and hall generators

Second letter

- A Diode (except tunnel, power Zener diodes, and radiation-sensitive diode, reference diode, and voltage regulator, tuner diode)
- B Variable capacitance diode (tuning diode)
- C Transistor for AF application ($R_{th\text{ JC}} > 15\text{ K/W}$)
- D Power transistor for AF application ($R_{th\text{ JC}} < 15\text{ K/W}$)
- E Tunnel diode
- F RF transistor ($R_{th\text{ JC}} > 15\text{ K/W}$)
- G Multichips, etc.
- H Hall field probe
- L RF power transistor ($R_{th\text{ JC}} < 15\text{ K/W}$)
- N Opto couplers
- P Radiation-sensitive semiconductor component (e.g. photo voltaic cell)
- Q Radiation generating semiconductor component (e.g. light emitting diode)
- R Electrically triggered control or switching components having a breakdown characteristic ($R_{th\text{ JC}} > 15\text{ K/W}$), e.g. thyristor tetrode
- S Transistor for switching applications ($R_{th\text{ JC}} > 15\text{ K/W}$)
- T Electrically or light-triggered control and switching components having a breakdown characteristic ($R_{th\text{ JC}} < 15\text{ K/W}$), e.g. thyristor tetrode, controllable power rectifier diode
- U Power transistor for switching applications ($R_{th\text{ JC}} < 15\text{ K/W}$)
- X Multiplier-diode, e. g. varactor, step-recovery diode
- Y Power diode, rectifying diode, booster diode
- Z Reference or voltage regulator diode Z diode (formerly Zener diode). For the types described under 2, the letters Z, Y or X are used as a **third letter**.

The numbers following the letter are only used for consecutive numbering, they have no technical significance.

2.2. Explanation of the Terms 'Maximum Ratings' and 'Characteristics' (DIN 41791)

Maximum Ratings

The maximum ratings indicated in the data sheets are absolute maximum values. The exceeding of only one of these values may result in the destruction of the semiconductor component even if the other maximum values are not fully utilized. Unless otherwise specified, the maximum ratings apply to 25 °C.

Characteristics

Characteristics are the features of a semiconductor component which are typical for the behavior at defined operating points.

The static characteristics indicate the DC behavior, the dynamic characteristics the behavior during AC or pulse operation. The behavior of a component type is specified by characteristics (either data or curves), but due to the individual deviations they cannot be considered as the accurate data for each single component. The deviation ranges are shown either as data or as characteristic curves.

2.3. Notation and List of the Symbols and Terms Used (DIN 41785)

The current, voltage, power (AC, DC, or average values) and resistance types (AC or DC values) are indicated by using capital and small letters for the symbols.

2.3.1. Symbols

The instantaneous data of values varying with time are indicated by small letters.

Examples: i, v, p

Capital letters are used for DC, average, rms, and peak values of periodical functions of the current, the voltage, and the power – i.e. for constant quantities.

Examples: I, V, P

Subscripts for the symbols

The following subscripts are used:

E, e	Emitter
B, b	Base
C, c	Collector
F, f	Forward direction (diode operated in forward direction)
R, r	Reverse direction (diode operated in reverse direction)
M, m	Peak value
av	Average value

The subscripts for peak and average values may be omitted, provided that a confusion with other values is impossible.

Total values (instantaneous values, DC values, average, rms, and peak values) referred to a zero point are indicated by subscripts with capital letters.

Examples: $i_C, I_C, v_{BE}, V_{BE}, P_C$

Subscripts with small letters are used for the values of variable components (e.g. for instantaneous values, peak, and rms values referred to an average value).

Examples: $i_c, I_c, v_{be}, V_{be}, P_c$

To distinguish between peak, average, and rms values, further subscripts may be added. The following abbreviations are recommended:

Peak values M, m

Average values Av, av

Examples: $I_{CM}, I_{CAV}, I_{cm}, I_{cav}$

Peak values may also be indicated by placing the symbol "∧" over the letter.

Examples: \hat{I}_C, \hat{I}_c

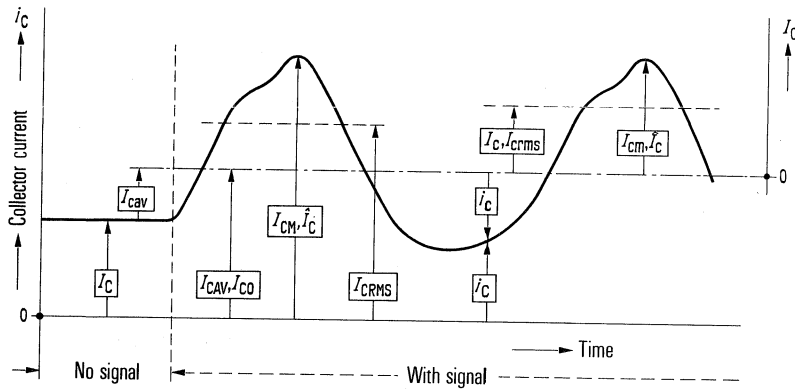

- I_C DC value, no signal
- I_{CAV} Average value of the total current (referred to zero)
- I_{CM}, \hat{I}_C Peak value of the total current (referred to zero)
- I_{CRMS} RMS value of the total current (referred to zero)
- I_{cav} Average value of the variable component superimposed on the closed-circuit direct current I_C (referred to the DC no-signal value I_C).
- $I_c, I_{c,rms}$ RMS value of the variable component (referred to the average value I_{CAV})
- I_{cm}, \hat{I}_c Peak value of the variable component (referred to the average value I_{CAV})
- i_C Instantaneous total value (referred to zero)
- i_c Instantaneous value of the variable component (referred to the average value I_{CAV})

The following relations apply to the values indicated in the above-mentioned diagram:

$$I_{CAV} = I_C + I_{cav}$$

$$\hat{I}_{CM} = I_C + \hat{I}_{cm}$$

$$I_{CRMS} = \sqrt{I_{CAV}^2 + I_{c,rms}^2}$$

$$I_C = I_{CAV} + i_c$$

Basic symbol chart

The following chart illustrates the application of capital and small letter symbols.

		Symbols	
		<i>i, v, p</i>	<i>I, V, P</i>
Subscripts	e b c f r m av	Instantaneous value of the variable component	RMS, average, and peak value of the variable component
	E B C F R M AV	Instantaneous total value (as referred to zero)	DC value, average, rms, and peak value (as referred to zero)

Instructions for the subscript sequence

Voltages

As a rule, two subscripts are used to indicate the points between which the voltage is measured.

Positive numerical values of the voltages correspond to positive potentials on the point indicated by the first subscript as referred to the point indicated by the second subscript (point of reference).

The second subscript may be omitted if this cannot lead to confusion or misunderstandings.

A supply voltage may be indicated by repeating the subscript of the terminal concerned.

Examples: V_{EEB} , V_{BBC} , V_{CCE}

Currents

As a rule, at least one subscript is used. Positive numerical values of the current correspond to positive currents entering the component at the terminal indicated by the first subscript.

Subscripts for Terminals

In the case of components having more than one terminal of the same type, the subscripts for the terminals may be modified by suffixing a number to them. Subscript and suffix must be written on the same line.

Example: V_{B2-E} (voltage between second base terminal and emitter)

If several components form an assembly, the subscripts for the terminals may be modified by prefixing a number to them, subscript and prefix having to be written on the same line.

Example: V_{1B-2B} (voltage between the base of the first component and the base of the second component)

Admittances, resistances, four-pole network coefficients, etc.

Symbols

Small letters with appropriate subscripts are used for four-pole network coefficients, as well as resistances, admittances, capacitances, inductances, etc., which describe the features of the component.

Examples: $h_{11b}, h_{11e}, Z_{21b}, Y_{22c}$

Capital letters with appropriate subscripts are used for four-pole network coefficients, as well as resistances, admittances, capacitances, inductances, etc. of external network or of networks in which the component forms just a part.

Examples: $H_{11b}, H_{11e}, Z_{21b}, Y_{22c}$

Capital-letter subscripts are used for DC values (including large-signal values) of four-pole network coefficients, as well as, of resistances, admittances, etc.

The DC value is the slope of the straight line from the origin of the coordinate system to the operating point on the characteristic of the component.

Examples: r_B, h_{11B}, h_{FE}

Small-letter subscripts are used for AC values (small-signal values) of four-pole network coefficients, as well as of resistances, admittances, capacitances, inductances, etc.

Examples: r_{bb}, h_{11b}, h_{fe}

The first subscript or the first pair of subscripts written in the manner customary for matrix elements is used for determining the elements of a four-pole network matrix.

11 (or i) = input

22 (or o) = output

21 (or f) = forward transfer

12 (or r) = reverse transfer

Examples: $V_1 = h_{11} \cdot I_1 + h_{12} \cdot V_2$
 $I_2 = h_{21} \cdot I_1 + h_{22} \cdot V_2$

Note

When written in matrix representation (or as elements of matrixes) the voltage and current symbols are supplemented by a subscript consisting of a single numeral.

Subscript 1 = input

Subscript 2 = output

The second subscript or the subscript following the pair of numerals indicates the basic circuit.

If the common terminal is self-evident, the second subscript may be omitted.

e = common emitter configuration

b = common base configuration

c = common collector configuration

Examples: (common base configuration):

$$I_1 = y_{11b} \cdot V_{1b} + y_{12b} \cdot V_{2b}$$

$$I_2 = y_{21b} \cdot V_{1b} + y_{22b} \cdot V_{2b}$$

If the transistor is described with a four-pole characteristic, it is recommended to fix the direction arrows for the input and output currents in the direction of the four-pole network.

2.3.2. Alphanumerical list of the symbols used

<i>a</i>	On-off base current ratio
<i>A</i>	Anode
<i>b</i>	Imaginary part of <i>y</i> -parameters
<i>b</i> ₁₁	Imaginary part of the short-circuit input admittance (of parameter <i>y</i> ₁₁)
<i>b</i> ₁₂	Imaginary part of the short-circuit reverse transfer admittance (of parameter <i>y</i> ₁₂)
<i>b</i> ₂₁	Imaginary part of the short-circuit forward transfer admittance of parameter <i>y</i> ₂₁)
<i>b</i> ₂₂	Imaginary part of the short-circuit output admittance (of parameter <i>y</i> ₂₂)
<i>B, b</i>	Base terminal
<i>C, c</i>	Collector terminal
<i>C</i>	Capacitance
<i>C</i> _{b'c}	Intrinsic base collector capacitance
<i>C</i> _{b'e}	Intrinsic base emitter capacitance
<i>C</i> _c	Collector junction capacitance (in general)
<i>C</i> _{case}	Case capacitance (in general)
<i>C</i> _{cb}	Collector base capacitance
<i>C</i> _{CBO}	Collector base capacitance (including case capacitance) with open emitter (<i>I</i> _E = 0)
<i>C</i> _{c,b}	Intrinsic collector base capacitance
<i>C</i> _{ce}	Collector-emitter capacitance
<i>C</i> _{eb}	Emitter-base capacitance
<i>C</i> _{EBO}	Emitter-base capacitance (including case capacitance) with collector open (<i>I</i> _C = 0)
<i>C</i> _{eb,r}	Intrinsic emitter base capacitance
<i>C</i> _{ib}	Input capacitance
<i>C</i> _L	Load capacitance
<i>C</i> _{ob}	Output capacitance
<i>C</i> _{th}	Thermal capacity (disregarding of heat dissipation to the environment)
<i>C</i> ₁₁	Capacitance of the short-circuit input admittance (of parameter <i>y</i> ₁₁)
<i>C</i> ₁₂	Capacitance of the short-circuit reverse transfer admittance (of parameter <i>y</i> ₁₂)
<i>C</i> ₂₁	Capacitance of the short-circuit forward transfer admittance (of parameter <i>y</i> ₂₁)
<i>C</i> ₂₂	Capacitance of the short-circuit output admittance (of parameter <i>y</i> ₂₂)
<i>D</i>	Duty cycle (more recently used abbreviation)
<i>E, e</i>	Emitter terminal
Δf	Frequency difference
<i>f</i>	Frequency
<i>f</i> _c	Cutoff frequency
<i>f</i> _{hfb}	Cutoff frequency of the short-circuit small signal current gain in common base configuration
<i>f</i> _{hfe}	Cutoff frequency of the short-circuit small signal current gain in common emitter configuration
<i>f</i> _{hfe1}	Frequency at which <i>h</i> _{fe} = 1
<i>f</i> _{max}	Maximum frequency of oscillation
<i>f</i> _T	Transition frequency (Current gain-bandwidth product)
<i>g</i>	Real part of the <i>y</i> -parameters
<i>g</i>	Conductance (instantaneous value)

$g_{b'c}$	Intrinsic base collector conductance
$g_{b'e}$	Intrinsic base emitter conductance
g_{ce}	Collector emitter conductance
g_{th}	Coefficient of thermal conductivity (instantaneous total value)
g_{thJC}	Coefficient of thermal conductivity (total instantaneous value) between heat source and case, with infinitely good heat dissipation from the case ($T_{case} = T_{amb}$)
g_{11}	Real component of the short-circuit input admittance (of parameter y_{11})
g_{12}	Real component of the short-circuit reverse transconductance (of parameter y_{12})
g_{21}	Real component of the short-circuit forward transconductance (of parameter y_{21})
g_{22}	Real component of the short-circuit output admittance (of parameter y_{22})
G	Conductance (DC or average value)
G_A	Anode gate
G_g	Internal conductance of generator
G_K	Cathode gate
G_L	Load conductance
G_p	Power gain
G_{pb}	Power gain in common base configuration
G_{pe}	Power gain in common emitter configuration
G_{popt}	Power gain, optimum
G_{pbinv}	Reverse power loss (feedback damping)
G_{pbopt}	Power gain in common base configuration, optimum
G_{peopt}	Power gain in common emitter configuration, optimum
G_{th}	Coefficient of thermal conductivity (thermal conduction constant)
G_{thJC}	Coefficient of thermal conductivity (thermal conduction constant) between heat source and case, with infinitely good heat dissipation from the case ($T_{case} = T_{amb}$)
G_{thA}	Coefficient of thermal conductivity (thermal conduction constant) between heat source and static ambient air when using a cooling plate of defined size
G_{thJA}	Coefficient of thermal conductivity (thermal conduction constant) between heat source and static ambient air.
G_V	Voltage gain
h	Parameter of the hybrid-matrix (h -matrix)
h_{11}	Short-circuit input impedance
h_{12}	Open circuit reverse voltage transfer ratio (voltage feedback ratio h_{re})
h_{21}	Short-circuit forward current transfer ratio (small signal current gain)
h_{22}	Open-circuit output admittance
h_{FE}	DC current gain in common emitter configuration (static forward current transfer ratio)
h_{re}	Small-signal current gain in common emitter configuration ($\beta = h_{21e}$)
h_{feo}	Small-signal current gain in common emitter configuration at $f = 1$ kHz (Dynamic short-circuit forward current transfer ratio in common emitter configuration)

i_1	Input AC current
i_2	Output AC current (in general)
I_B	Base current (DC or average value)
I_{B1}	Control current, base-one current (UJT)
I_{B2}	Turn-off base current, on-off base current (UJT)
I_{BM}	Peak base current
I_C	Collector current (DC or average value)
I_{CBO}	Collector cutoff current with open emitter ($I_E = 0$)
I_{CEO}	Collector cutoff current with open base ($I_B = 0$)
I_{CER}	Collector cutoff current with $R_{BE} = R$ (with a resistance R_{BE} between base and emitter)
I_{CES}	Collector cutoff current with short-circuited emitter diode ($V_{BE} = 0$)
I_{CEV}	Collector cutoff current with reverse emitter diode
I_{CM}	Peak collector current
I_E	Emitter current (DC or average value)
I_{EBO}	Emitter cutoff current with open collector ($I_C = 0$)
I_{EM}	Peak emitter current
I_{FM}	Peak forward current
I_{FS}	Surge current, maximum 1 sec
I_K	Short-circuit current
I_o	Rectified current
I_R	Reverse current
k	Distortion factor
K	Cathode
L	Inductance
L_s	Series inductance
m	In a subscript: maximum (peak value)
m	Degree of modulation
max	in a subscript: maximum (e.g. upper scattering limit)
min	in a subscript: minimum (e.g. lower scattering limit)
M	in a subscript: maximum (peak value)
NF	Noise figure
$P; p$	Power dissipation
P_p	Pulse power dissipation
P_{tot}	Total power dissipation
φ	Phase of y-parameters
φ_{11}	Phase of the short-circuit input admittance (of parameter y_{11})
φ_{12}	Phase of the short-circuit reverse transfer admittance (of parameter y_{12})
φ_{21}	Phase of the short-circuit forward transfer admittance (of parameter y_{21})
φ_{22}	Phase of the short-circuit output admittance (of parameter y_{22})
Q	Quality factor, Q factor

r	Resistance (instantaneous value)
r_{bb}	Base intrinsic resistance
$r_{bb}, C_{b,c}$	Feedback time constant
r_{cc}	Collector intrinsic resistance
r_{eb}	Emitter intrinsic resistance
R	Resistance (DC or average value)
R_{BE}	Resistance between base and emitter
R_g	Internal resistance of generator
R_L	Load resistance
R_s	Series resistance
R_{thJC}	Thermal resistance between junction (heat source) and case at infinitely good heat dissipation from the case ($T_{case} = T_{amb}$)
R_{thc}	Thermal resistance of a chassis plate (cooling plate, no heat sink)
R_{thJA}	Thermal resistance between junction (heat source) and static ambient air
t	Time
t_d	Delay time
t_f	Fall time
t_{gt}	Gate controlled turn-on time
t_{gq}	Gate controlled turn-off time
t_{off}	Turn-off time ($t_{off} = t_s + t_f$)
t_{on}	Turn-on time ($t_{on} = t_d + t_r$)
t_p	Pulse duration
t_h	In a subscript: thermal
t_q	Circuit commutated turn-off time
t_r	Rise time
t_{rr}	Reverse recovery time
t_s	Storage time
T	Temperature
T_{case}	Case temperature
T_j	Junction temperature
Tr	Abbreviation for "transistor"
T_{stg}	Storage temperature
T_{amb}	Ambient temperature
\dot{u}	Saturation factor
v	Voltage (instantaneous value)
V_{FM}	Peak forward voltage
V_{RF}	Input RF voltage
V_{RM}	Peak reverse voltage
V_{RS}	Maximum surge voltage, 1 sec
V_1	Input AC voltage
V_2	Output AC voltage
V	Voltage (DC or average value)
V_{batt}	Battery voltage
V_{BB}	Base supply voltage
V_{BE}	Base emitter voltage
$V_{(BR)}$	Breakdown voltage
V_{CB}	Collector base voltage
V_{CBO}	Collector-base voltage with open emitter ($I_E = 0$)
V_{CC}	Collector supply voltage

V_{CE}	Collector-emitter voltage
V_{CEO}	Collector-emitter (reverse) voltage base open ($I_B = 0$)
V_{CER}	Collector-emitter (reverse) voltage with a resistor between base and emitter
V_{CES}	Collector-emitter voltage with short-circuited emitter diode ($V_{BE} = 0$)
V_{CEsat}	Collector-emitter saturation voltage
V_{CEV}	Collector-emitter (reverse) voltage with reverse base emitter diode
V_i	Input voltage
V_{EBO}	Emitter-base voltage with open collector ($I_C = 0$)
V_F	Forward voltage
V_O	Open-circuit voltage
V_p	Pinch-off voltage
V_{pp}	Output voltage (measured peak-to-peak)
V_t	Tuning voltage
Y	Parameter of the admittance matrix (y-matrix)
Y_{11}	Short-circuit input admittance
Y_{12}	Short-circuit reverse transfer admittance
Y_{21}	Short-circuit forward transfer admittance
Y_{22}	Short-circuit output admittance.
z_{12}	Reverse impedance with open input
Z_1	Input impedance (general)
Z_2	Output impedance (general)
v	Duty cycle (Tr)
ω	Angular frequency $\omega = 2 \times \pi \times f$

2.3.3. Alphabetical list of the terms used

Abbreviation for "transistor"	T_r
Ambient temperature	T_{amb}
Angular frequency $\omega = 2 \times \pi \times f$	ω
Anode	A
Anode gate	G_A
Base, base terminal	B, b
Base current (DC or average value)	I_B
Base dropping resistor	R_{BB}
Base emitter voltage	V_{BE}
Base intrinsic resistance	$r_{bb'}$
Base supply voltage	V_{BB}
Battery voltage	V_{batt}
Breakdown voltage	V_{BR}
Capacitance	C
Capacitance of the short-circuit forward transfer admittance (of parameter y_{21})	C_{21}
Capacitance of the short-circuit input admittance (of parameter y_{11})	C_{11}
Capacitance of the short-circuit output admittance (of parameter y_{22})	C_{22}
Capacitance of the short-circuit reverse transfer admittance (of parameter y_{12})	C_{12}
Case capacitance (in general)	C_{case}
Case temperature	T_{case}
Cathode gate	G_K
Circuit commutated turn-off time	t_q
Coefficient of thermal conductivity (thermal conduction constant)	G_{th}
Coefficient of thermal conductivity (thermal conduction constant) between heat source and case, with infinitely good heat dissipation from the case ($T_{case} = T_{amb}$)	G_{thJC}
Coefficient of thermal conductivity (thermal conduction constant) between heat source and static ambient air when using a cooling plate of defined size	G_{thA}
Coefficient of thermal conductivity (thermal conduction constant) between heat source and static ambient air	G_{thJA}
Coefficient of thermal conductivity (instantaneous total value)	g_{th}
Coefficient of thermal conductivity (total instantaneous value of thermal conduction between heat source and case, with infinitely good heat dissipation from the case)	g_{thJC}
Collector, collector terminal	C, c
Collector base capacitance	C_{cb}
Collector base capacitance (incl. case capacitance) with open emitter, $I_E = 0$	C_{CBO}
Collector base voltage	V_{CB}
Collector-base voltage with open emitter ($I_E = 0$)	V_{CBO}
Collector current (DC or average value)	I_C
Collector cutoff current with open emitter ($I_E = 0$)	I_{CBO}
Collector cutoff current with open base ($I_B = 0$)	I_{CEO}
Collector cutoff current with $R_{BE} = R$ (with a resistance R_{BE} between base and emitter)	I_{CER}
Collector cutoff current with short-circuited emitter diode ($V_{BE} = 0$)	I_{CES}
Collector cutoff current with reverse emitter diode	I_{CEV}
Collector-emitter case capacitance	C_{ce}
Collector emitter conductance	g_{ce}
Collector intrinsic resistance	r_{cc}

Collector emitter voltage	V_{CE}
Collector-emitter (reverse) voltage base, open ($I_B = 0$)	V_{CEO}
Collector-emitter (reverse) voltage with a resistor between base and emitter $R_{BE} = R$	V_{CER}
Collector-emitter voltage with short-circuited emitter diode ($V_{BE} = 0$)	V_{CES}
Collector-emitter saturation voltage	V_{CEsat}
Collector-emitter (reverse) voltage with reverse base emitter diode	V_{CEV}
Collector junction capacitance (in general)	C_C
Collector supply voltage	V_{CC}
Collector terminal	C, C
Conductance (DC or average value)	G
Conductance (instantaneous value)	g
Control current, base – one current (UJT)	I_{B1}
Cutoff frequency	f_C
Cutoff frequency of the short-circuit small signal current gain in common base configuration	f_{hfb}
Cutoff frequency of the short-circuit small signal current gain in common emitter configuration	f_{hfe}
DC current gain in common emitter configuration (static forward current) transfer ratio)	h_{FE}
Degree of modulation	m
Delay time	t_d
Distortion factor	k
Duty cycle	$v(D)$
Emitter	E, e
Emitter base capacitance	C_{eb}
Emitter base capacitance (incl. case capacitance) with collector open $I_C = 0$	C_{EBO}
Emitter base voltage	V_{EB}
Emitter-base voltage with open collector ($I_C = 0$)	V_{EBO}
Emitter current (DC or average value)	I_E
Emitter cutoff current with open collector ($I_C = 0$)	I_{EBO}
Emitter intrinsic resistance	r_{eb}
Fall time	t_f
Forward current (DC or average value)	I_F
Forward voltage	V_F
Frequency	f
Frequency at which $h_{fe} = 1$	f_{hfe1}
Gate controlled turn-on time (thyristors)	t_{gt}
Gate controlled turn-off time	t_{gq}
Imaginary part of y-parameters	b
Imaginary part of the short-circuit input admittance (of parameter y_{11})	b_{11}
Imaginary part of the short-circuit reverse transfer admittance (of parameter y_{21})	b_{12}
Imaginary part of the short-circuit forward transfer admittance (of parameter y_{21})	b_{21}
Imaginary part of the short-circuit output admittance (of parameter y_{22})	b_{22}
In a subscript: maximum (peak value)	m
In a subscript: maximum (e.g. upper scattering limit)	max

In a subscript: minimum (e.g. lower scattering limit)	min
In a subscript: maximum (peak value)	M
In a subscript: thermal	th
Inductance	L
Input AC current	i_1
Input AC voltage	v_1
Input impedance (general)	Z_1
Input RF voltage	v_{RF}
Input voltage	V_i
Interbase resistance	r_{BB}
Internal conductance of generator	G_g
Internal resistance of generator	R_g
Intrinsic base collector capacitance	C_{brc}
Intrinsic base collector conductance	g_{brc}
Intrinsic base emitter conductance	g_{bre}
Intrinsic base emitter capacitance (incl. base capacitance) with collector open ($I_C = 0$)	$C_{b're}$
Intrinsic collector base capacitance	$C_{c'b}$
Junction temperature	T_j
Load capacitance	C_L
Load conductance	G_L
Load resistance	R_L
Maximum frequency of oscillation	f_{max}
Maximum surge voltage, 1 sec.	v_{RS}
Noise figure	NF
On-off base current ratio	a
Open-circuit output admittance	h_{22}
Open circuit reverse voltage transfer ratio (voltage feedback ratio h_{re}) $h_{12} \triangleq h_r$	h_{12}
Open circuit voltage	V_o
Output AC (in general)	i_2
Output AC voltage	v_2
Output capacitance	C_{ob}
Output impedance (general)	Z_2
Parameter of the admittance matrix (y-matrix)	y
Parameter of the hybrid-matrix (h-matrix)	h
Peak base current	I_{BM}
Peak collector current	I_{CM}
Peak emitter current	I_{EM}
Peak forward current	I_{FM}
Peak forward voltage	V_{FM}
Peak reverse voltage	V_{RM}
Phase of y-parameters	φ
Phase of the short-circuit input admittance (of parameter y_{11})	φ_{11}
Phase of the short-circuit reverse transfer admittance (of parameter y_{12})	φ_{12}
Phase of the short-circuit forward transfer admittance (of parameter y_{21})	φ_{21}
Phase of the short-circuit output admittance (of parameter y_{22})	φ_{22}
Pinch-off voltage	V_p

Power dissipation	$P;p$
Power gain	G_p
Power gain in common base configuration	G_{pb}
Power gain in common emitter configuration	G_{pe}
Power gain, optimum	G_{popt}
Power gain in common base, optimum	G_{pbopt}
Power gain in common emitter configuration, optimum	$G_{pe opt}$
Pulse duration	t_p
Pulse power dissipation	P_p
Quality factor, Q factor	Q
Real part of the y-parameters	g
Real component of the short-circuit input admittance (of parameter y_{11})	g_{11}
Real component of the short-circuit reverse transconductance (of parameter y_{12})	g_{12}
Real component of the short-circuit forward transconductance (of parameter y_{21})	g_{21}
Real component of the short-circuit output admittance (of parameter y_{22})	g_{22}
Rectified current	I_O
Resistance (instantaneous value)	r
Resistance (DC or average value)	R
Resistance between base and emitter	R_{BE}
Reverse current	I_R
Reverse impedance with open input	Z_{12}
Reverse power loss	$G_{pb inv}$
Reverse recovery time, reverse delay time	t_{rr}
Reverse transfer capacitance (feedback capacitance)	$-C_{12e}$
Rise time	t_r
Saturation factor	\ddot{u}
Series inductance	L_s
Series resistance	R_s
Short-circuit current	I_K
Short-circuit forward current transfer ratio $h_{21} = h_f$	h_{21}
Short-circuit forward transfer admittance	Y_{21}
Short-circuit input admittance	Y_{11}
Short-circuit input impedance	h_{11}
Short-circuit output admittance	Y_{22}
Short-circuit reverse transfer admittance	Y_{12}
Small signal current gain in common-emitter configuration ($\beta = h_{21e}$)	h_{fe}
Small signal current gain in common emitter configuration at $f = 1$ kHz	h_{feo}
Storage temperature range	T_{stg}
Storage time	t_s
Surge current, maximum 1 sec.	i_{FS}
Temperature	T
Thermal capacity (disregarding of heat dissipation to the environment)	C_{th}
Thermal resistance	R_{th}
Thermal resistance between junction (heat source) and case with infinitely good heat dissipation from the case ($T_{case} = T_{amb}$)	R_{thJC}
Thermal resistance of a chassis plate (cooling plate no heat sink)	R_{thc}

Thermal resistance between junction (heat source) and static ambient air when using a cooling plate of defined size	R_{thL}
Thermal resistance between junction (heat source) and static ambient air	R_{thJA}
Time	t
Total power dissipation	P_{tot}
Transition frequency (current gain bandwidth product)	f_T
Tuning voltage	V_t
Turn-off base current, On-off base current	I_{B2}
Turn-off time ($t_{off} = t_s + t_f$)	t_{off}
Turn-on time ($t_{on} = t_d + t_r$)	t_{on}
Voltage (DC or average value)	V
Voltage gain	G_v
Voltage (instantaneous value)	v

2.3.4. Explanation of the symbols and terms used

This section contains brief explanations of the symbols and terms used in the data sheets for transistors.

In order to distinguish between the different voltages and currents of the transistor, suffix letters are used.

The letters provide information on the connection mode of the transistor terminals. The order on which they are indicated together with the sign (+ or -) indicates the direction of the voltage or current. The technical concept of current flow applies (current flow from + to -).

The three transistor terminals are denoted as follows:

Emitter	<i>E</i>
Base	<i>B</i>
Collector	<i>C</i>

In order to characterize the cutoff currents and reverse voltages a third suffix letter is used. This letter provides information on the connection mode of the third terminal which is otherwise not mentioned.

The following abbreviations are used:

- O** The third, unmentioned terminal is open.
- R** Ohmic resistance between the terminal mentioned in the second place and the unmentioned terminal.
- S** Short circuit between the terminal mentioned in the second place and the unmentioned terminal.
- V** Reverse bias voltage between the terminal mentioned in the second place and the unmentioned terminal.

2.4. Technical Explanations

2.4.1. Basic transistor configurations

Common emitter configuration

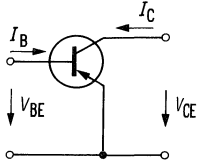

Common base configuration

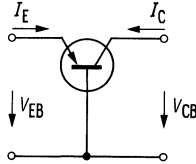

Common collector configuration

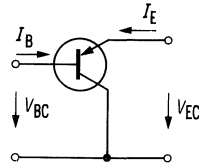

Characteristics of the basic configurations

	Common emitter configuration	Common base configuration	Common collector configuration
Input impedance	medium	low	high
Z_1	Z_{1e}	$Z_{1b} \approx \frac{Z_{1e}}{h_{fe}}$	$Z_{1c} \approx h_{fe} \cdot R_L$
Output impedance	high	very high	low
Z_2	Z_{2e}	$Z_{2b} \approx Z_{2e} \cdot h_{fe}$	$Z_{2c} \approx \frac{Z_{1e} + R_g}{h_{fe}}$
Small-signal current gain	high	< 1	high
	h_{fe}	$h_{fb} \approx \frac{h_{fe}}{h_{fe}+1}$	$\gamma \approx h_{fe} + 1$
Voltage gain	high	high	< 1
Power gain	very high	high	medium
Cutoff frequency	low	high	low
	f_{hfe}	$f_{hfb} \approx h_{fe} \cdot f_{hfe}$	$\approx f_{hfe}$

Explanations of important electrical characteristics

e.g. current and voltage at silicon NPN transistors

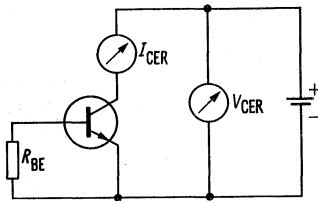

V_{CER} (I_{CER})
 Collector-emitter reverse voltage
 (collector-emitter cutoff current)
 with a resistor between base
 and emitter. The maximum
 permissible resistance value R_{BE}
 is specified in the data sheets. The
 reverse voltage V_{CEO} applies to
 higher values of R_{BE}

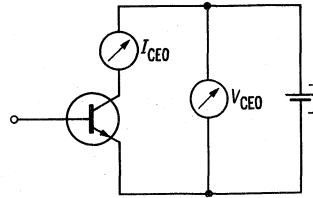

V_{CEO} (I_{CEO})
 Collector-emitter reverse voltage
 (collector-emitter cutoff current)
 with base open: $I_B = 0$. The state
 $I_B = 0$ may also occur for a short
 while, e.g. in operation as a
 switch, with a resistance
 interposed between base and
 emitter.

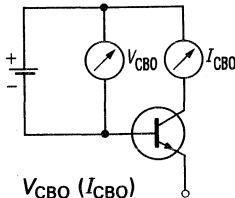

V_{CBO} (I_{CBO})
 Collector-base reverse voltage
 (collector-base cutoff current)
 with emitter open: $I_E = 0$

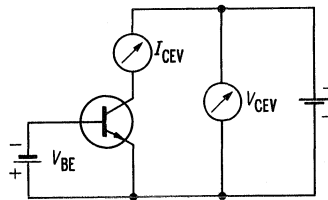

V_{CEV} (I_{CEV})
 Collector-emitter reverse voltage
 (collector-emitter cutoff current)
 with blocked emitter diode, i.e.,
 reverse bias voltage between
 base and emitter

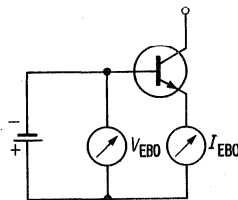

V_{EBO} (I_{EBO})
 Emitter-base reverse voltage
 (emitter-base cutoff current)
 with collector open: $I_C = 0$

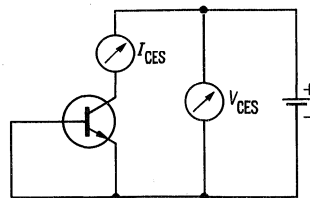

V_{CES} (I_{CES})
 Collector-emitter reverse voltage
 (collector-emitter cutoff current)
 with shorted emitter diode:
 $V_{BE} = 0$

2.4.2. Permissible total power dissipation of transistors

The permissible dissipation of power transistors versus the ambient temperature T_{amb} , with the voltage V_{CE} as parameter, is stated in a family of curves.

These curves are based on uniform reliability. According to these curves, the permissible total power dissipation decreases with increasing collector voltage.

The following curves have to be considered as examples

At load operation, the heat in the chip of the semiconductor component is not equally distributed, but depends on the current and the applied voltage. At high collector voltages, the cross section in the semiconductor leading the current flow changes with increasing temperature gradient in the chip, so that the thermal resistance increases.

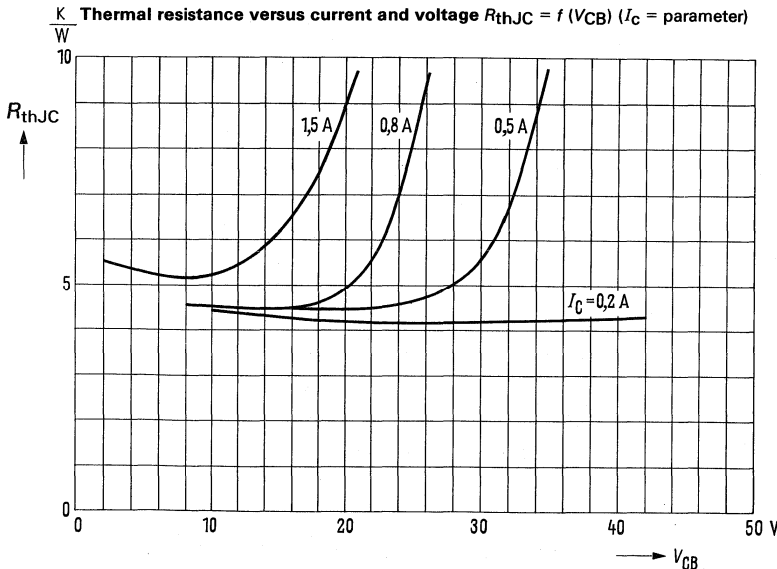
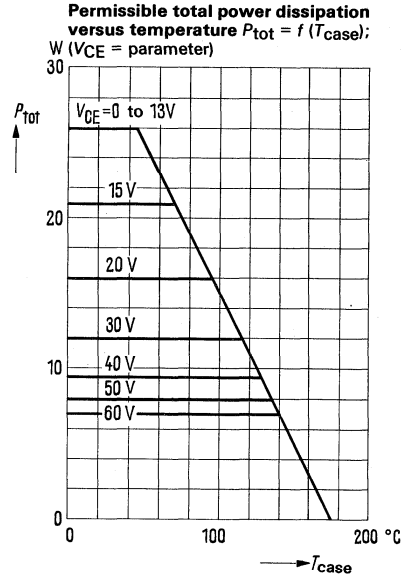

If this design and size-dependent behavior, of the semiconductor component, is not observed, a strong pinchoff effect sets in. Thus, at relatively low powers compared to the maximum permissible power dissipation the chip is heated to such an extent that it melts in certain areas, i. e. the transistor may be destroyed. The heat capacity of such a current channel is extremely low, so that time constants of, e.g., 10^{-7} sec. occur in spite of the high thermal resistance. The reverse voltage breaks down due to the suddenly existing high temperature. This effect is therefore called "second breakdown" which is practically in dependent of temperature. With transistors loads can be switched, the powers of which are higher than the static power dissipation. Usually the power dissipation valid for continuous load will be exceeded during a switching process. This is allowable, if the heat capacity of the chip and the heat dissipation prevent the losses occurring for a short time from heating the transistor chip beyond the maximum permissible junction temperature.

Diagrams are given to calculate the maximum occurring junction temperature. The demonstration of such diagrams is particularly necessary for power transistors and transistors where a higher load carrying capacity is achieved by mounting heat sinks.

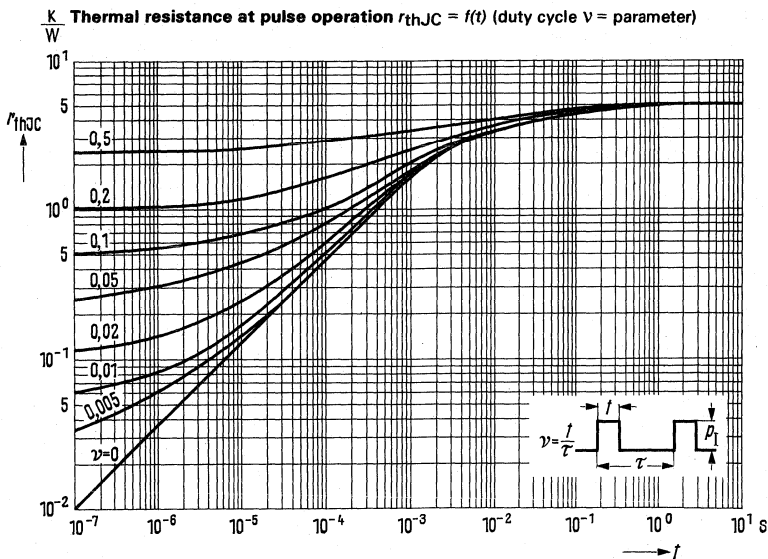

The diagram below has been derived from the thermal transient process of a transistor. The equivalent circuit of the thermal resistance R_{th} can be demonstrated as a line with distributed R and C networks. Due to the existing heat capacities transistors are able to withstand pulse powers greater than the statically permissible total power dissipation (compare DIN 41862).

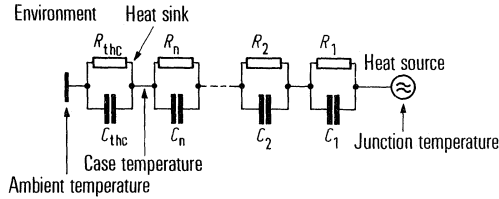

If the component is operated near the maximum permissible junction temperature two diagrams have to be considered for the calculation of the maximum junction temperature. The diagram for the thermal resistance versus time is valid without reservation for operation at a voltage range with no second breakdown. The voltage dependence of the thermal resistance has to be considered, however, if the voltage range is limited by a second breakdown. In this case the pulse thermal resistance $r_{thJC} = f(t)$ has to be multiplied by a voltage dependent correction factor K_V . This factor is determined from the diagram $P_{tot} = f(T_{case})$ as the ratio P_{tot} to P_v . P_{tot} is the maximum permissible power dissipation, P_v is the maximum permissible pulse dissipation at the voltage V_{CE} . The voltage dependent correction factor can also be calculated in a similar way for static load.

$$R_{thJC(V)} = K_V R_{thJC} = \frac{P_{tot}}{P_v} R_{thJC}$$

$$r_{thJC(V)} = K_V r_{thJC} = \frac{P_{tot}}{P_v} r_{thJC}$$

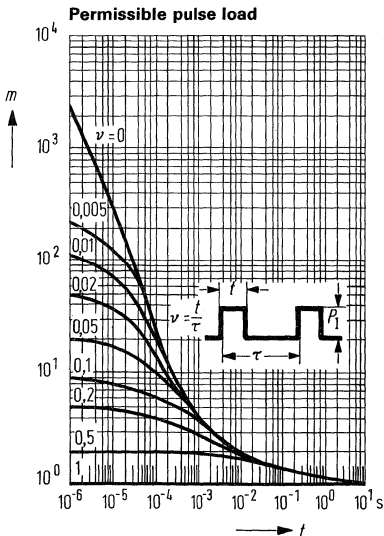

A maximum permissible pulse power dissipation P_p can be calculated with the help of the diagram 'permissible pulse load'.

First a factor m , valid for a specific duty cycle v (more recently D) and a specific pulse duration t , is read of the diagram.

Then P_v is determined by means of the diagram 'permissible total power dissipation versus temperature.'

Hence the maximum permissible pulse power dissipation results from the equation $P_p = m \cdot P_v$.

If the pulse shape is not rectangular the full pulse height has to be considered and for the pulse duration an approximation has to be made, which results from the pulse width at 20% of the total pulse height. A conversion into a rectangle of equal area is not permissible due to the complex thermal resistance.

The maximum of the junction temperature may then be calculated according to the equation:

$$T_j = (P_o + vP_p) \frac{(R_{thJV} - K_V R_{thJC})}{R_{thC}} + P_o K_V R_{thJC} + P_p K_V r_{thJC} + T_{amb}$$

If the maximum permissible junction temperature is exceeded the calculation has to be repeated with a larger heat sink.

The individual contributions to increase the junction temperature may be derived from the following example.

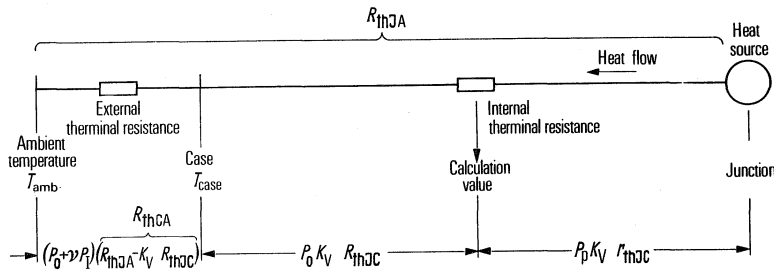

Meanings of the used symbols:

- P_p Peak value of the power dissipation (pulse power dissipation)
- P_o DC power dissipation
- vP_p Average value of the pulse power dissipation during a cycle
- t Duration of, the pulse power dissipation
- v^* Duty cycle $\frac{t}{\tau}$
- τ Period
- r_{thJC} Pulse thermal resistance
- K_V Voltage-dependent correction factor
- P_V Maximum permissible total power dissipation at V_{CE}
- R_{thCA} Thermal resistance between case and ambient air.

*) In more recent diagrams the duty cycle is indicated with a 'D'.

Power dissipation in a transistor when operated as a switch

Output pulse

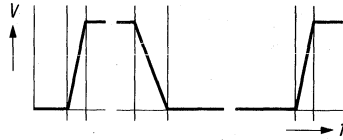

During a switching period the transistor is loaded by reverse, turn-on, forward, and turn-off power dissipation. The following illustrations show the timing diagrams of the power dissipation occurring in the transistor, for inductive, resistive, and capacitive load.

Transistor power dissipation at:

Inductive load

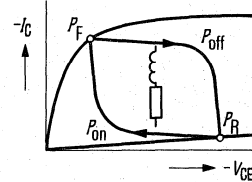
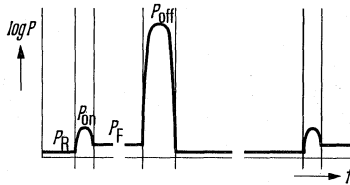

Resistive load

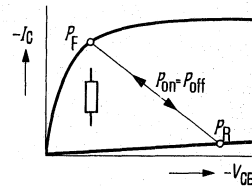

Capacitive load

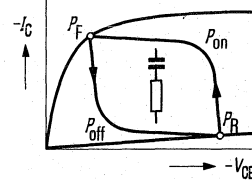

Instead of a wave-type curve a rectangular pulse form may be assumed when turning on or off. In case of a resistive or predominantly resistive load the simplifying assumption can be made that the turn-on pulse is immediately followed by the turn-off pulse. Under these conditions the following deductions may be made:

Load	Pulse	Pulse power dissipation	Power dissipation averaged over one cycle
L	t_{off}	P_{off}	$P_R + P_{on} + P_F$
R	$t_{on} + t_{off}$	$P_{on} = P_{off}$	$P_R + P_F$
C	t_{on}	P_{on}	$P_R + P_F + P_{off}$

- P_R Reverse power dissipation
- P_{on} Peak value of the turn-on power dissipation
- P_F Forward power dissipation
- P_{off} Peak value on the turn-off power dissipation

2.4.3. Permissible operating range

For almost all transistor types the permissible operating range (see diagram below) is indicated in the I_C/V_{CE} curves, like in the diagram below. Any combination of I_C and V_{CE} is permitted within this range.

Care must be taken that the idle period, specified in the characteristic curves, is not exceeded.

The families of curves stated in the diagrams comprise the voltage dependence ($P_{tot} = f(T_{case})$ curve) as well the current dependence. Moreover, they also show the repetition frequency of the maximum possible load.

The jogs of the curves result from the different maximum ratings, like maximum junction temperature, current carrying capability, and effects of the voltage dependence (second breakdown).

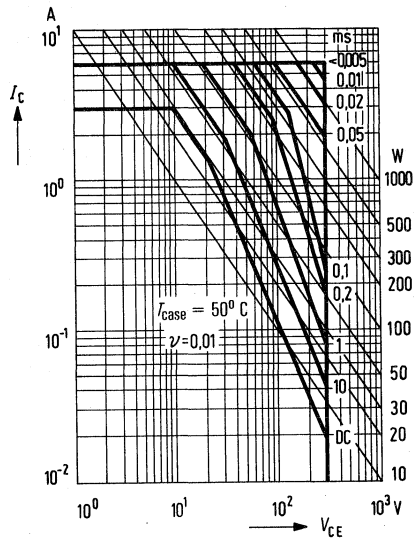

2.4.4. Heat dissipation of transistors

In order to obtain a more favorable heat dissipation, power transistors are mounted on chassis plates. In this case, R_{thJA} (see preceding section) is replaced by a thermal resistance applied between the junction via the chassis to the ambient R_{thA} .

$$R + hL = R_{thc} + R_{thJC}$$

The thermal resistance of the chassis plate R_{thc} is calculated on the basis of the following approximate equation (applies only to cooling plates – not for heat sinks):

$$R_{thc} = \frac{3,3}{\sqrt{\lambda d}} C^{0,25} + \frac{650}{A} C$$

λ Thermal conductivity coefficient for the chassis plate, in W/K cm

Material	λ (W/K cm)
Aluminum	2.1
Copper	3.8
Brass	1.1
Steel	0.46

d Thickness of chassis plate, in mm

A Surface of chassis plate, in cm^2

C Correction factor for position and surface characteristics of the chassis plate

Surface \ Position	Bare	Black
Vertical	0.85	0.43
Horizontal	1	0.5

The equation applies to chassis plates not deviating too much from the square form, and with the transistor, mounted in the center of the cooling plate, constituting the only heat source at the chassis. The values of the constants λ and C apply in static air up to an ambient temperature of approximately 45 °C, provided there are no heat-radiating parts nearby.

Heat-transfer resistance of a mica washer R_{th} (K/W)

Case	Disc thickness, dry		Disc greased on both sides will reduce resistance by:
	50 μ	100 μ	
TO-3	1.25	1.5	0.9 K/W
SOT-9	2.5	3	1.5 K/W
TO-126	8	10	4 K/W
TO-202	8	10	4 K/W

2.4.5. Switching characteristics of transistors

If transistors are used as switches, the output pulse is distorted and delayed compared with the input pulse.

The following diagram shows the switching behavior of a transistor in a common emitter configuration:

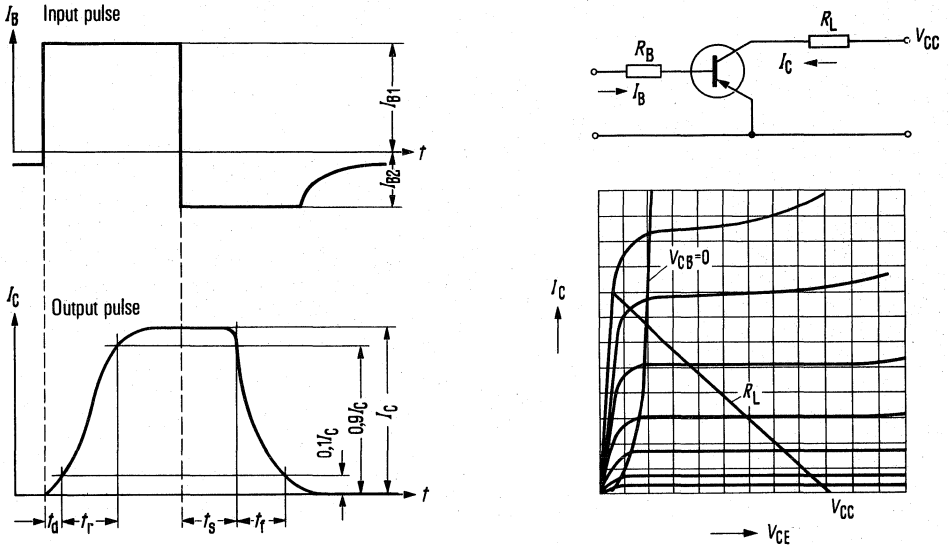

With the aid of the preceding illustration, the following times can be defined:

Turn-on time $t_{on} = t_d + t_r$

The turn-on time is the time required by the output current (collector current) to rise to 90% of its maximum value after the control current (base current) has been applied.

It is composed of the delay time t_d and the rise time t_r .

The delay time is the time required by the collector current to rise to 10% of its final value after the control pulse has been applied. The rise time is the time required by the collector current to rise from 10% to 90% of its final value.

Turn-off time $t_{off} = t_s + t_f$

The turn-off time is the time required by the output current to drop to 10% of its maximum value after completion of the control pulse.

It is composed of the storage time t_s and the fall time t_f .

The storage time is the time required by the output current (collector current) to drop to 90% of its maximum value after the control current (base current) has been removed.

The fall time is the time required by the output current (collector current) to drop from 90% to 10% of its maximum value.

The shortest switching times can be obtained, because of the high control currents, in common base configuration, whereas the turn-off time at collector stages is particularly low which is due to a lacking saturation.

The following explanation of the switching times applies to a saturated operation in common emitter configuration.

The symbols indicate in this case:

I_{B0} Base current which drives the transistor up to the saturation limit

$I_{B1} > I_{B0}$ Turn-on base current

$I_{B2} \geq I_{B0}$ On-off base current

a) Delay time t_d

t_d is the time which passes after the control signal has been applied until the emitter base junction capacitance C_{EB} is recharged and the emitter diode polarized in forward direction. t_d grows shorter at an increasing control current I_{B1} . With power transistors it can often be noticed that $t_d \ll t_r$.

b) Rise time t_r

During the rise time, the control load in the base has to be built up via the control current.

According to the definition $t_r = T_C \ln \frac{I_{B1}/I_{B0} - 0,1}{I_{B1}/I_{B0} - 0,9}$

The component factor T_C (time constant at current control) approximates the service life of a carrier, i.e. typical value with power transistors is 1-10 μs , and with fast switches it is one to two orders of magnitude lower. The operating point factor shows that t_r becomes very low at high control currents $I_{B1} \gg I_{B0}$. t_r rises with an increasing I_C , owing to its dependence on the current gain.

c) Storage time t_s

After the saturation limit has been reached, the base current portion $I_{B1} > I_{B0}$ is used for building up the maximum possible stored load.

When turning off, I_C cannot reduce itself until this stored load has been decreased during t_s first.

This means that $t_s = T_{stg} \ln \frac{I_{B2}/I_{B0} + I_{B1}/I_{B0}}{I_{B2}/I_{B0} + 1} + t(90\% I_C)$

The second term which describes the decrease of I_C down to 90%, as stated in the definition, can generally be neglected with respect to the first term. The storage time constant T_{stg} can also be compared with the service life of a carrier (see b). The operating point factor shows that short storage times can be obtained at a low I_{B1} together with a high on-off current I_{B2} . If h_{FE} decreases – I_{B0} increases – towards high collector currents, the storage time decreases accordingly.

d) Fall time t_f

During the fall time, the base control load together with I_C decrease theoretically according to the following equation

$$t_f = T_C \ln \frac{I_{B2}/I_{B0} + 0,9}{I_{B2}/I_{B0} + 0,1}$$

This equation, which results in a reduction of t_f at a high on-off current, applies in practice only to transistors without any collector storage load, i.e. to epibase, and single diffused transistors, or to the voltage planar transistors. With high voltage triple diffused types, however, t_f depends on how the collector residual load can be removed via the base from the transistor during turning off. In practical applications this process frequently results in an increase of t_f with I_{B2} , and of I_C . A rise with I_{B1} is also often noticed, though this is not expressed in the above-mentioned equation.

The switching time specifications for fast high voltage power switches can particularly easily be indicated and examined in the following approved test circuit.

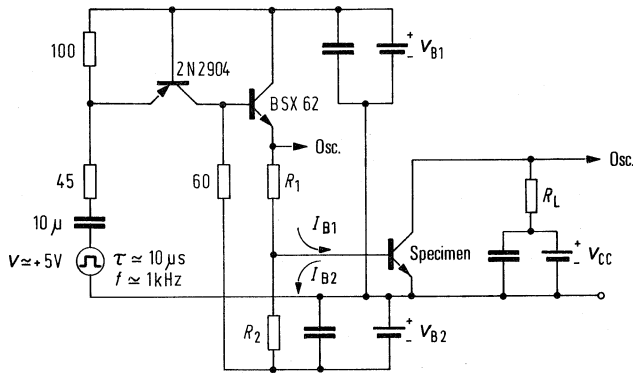

The designed control circuit is appropriate if there is no pulse generator for several Amperes control current. The following relation between the desired currents and the corresponding resistances applies:

$$R_1 \approx \frac{V_{B1} - V_{BEsat}}{I_{B1} + |I_{B2}|} \quad (V_{CEsat} \text{ of the BSX 62} \approx 0 \text{ V})$$

$$R_2 = \frac{|V_{B2}| + V_{BEsat}}{|I_{B2}|}$$

$$R_L = \frac{V_{CC} - V_{CEsat}}{I_C}$$

The voltage specifications below are recommended for triple diffused transistors:

$$V_{CC} = 60 \text{ V}$$

$$V_{B1} = 11 \text{ V}$$

$$|V_{B2}| = 5 \text{ V}$$

The approximation $V_{BEsat} \approx 1 \text{ V}$, $V_{CEsat} \approx 0 \text{ V}$ can be assumed for the tested transistors.

2.4.6. The transistor as linear two-port

Description of the transistor by h parameters in the AF range

The h or hybrid parameters are generally specified as real values.

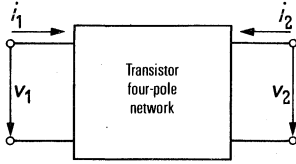

$$v_1 = h_{11} \cdot i_1 + h_{12} \cdot v_2$$

$$i_2 = h_{21} \cdot i_1 + h_{22} \cdot v_2$$

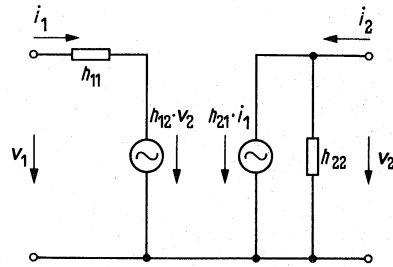

$$h_{11} = \left(\frac{v_1}{i_1} \right)_{v_2=0} \quad \text{Short-circuit input impedance}$$

$$h_{12} = \left(\frac{v_1}{v_2} \right)_{i_1=0} \quad \text{Open-circuit reverse voltage transfer ratio}$$

$$h_{21} = \left(\frac{i_2}{i_1} \right)_{v_2=0} \quad \text{Short-circuit forward current transfer ratio}$$

$$h_{22} = \left(\frac{i_2}{v_2} \right)_{i_1=0} \quad \text{Open-circuit output admittance}$$

Relation between the h parameters in common base and common emitter configurations

$$\begin{pmatrix} h_{11b} & h_{12b} \\ h_{21b} & h_{22b} \end{pmatrix} = \frac{1}{1 + h_{21e} - h_{12e} + \Delta h_e} \begin{pmatrix} h_{11e} & -(h_{12e} - \Delta h_e) \\ -(h_{21e} + \Delta h_e) & h_{22e} \end{pmatrix}$$

$$\begin{pmatrix} h_{11b} & h_{12b} \\ h_{21b} & h_{22b} \end{pmatrix} \approx \frac{1}{1 + h_{21e}} \begin{pmatrix} h_{11e} & -(h_{12e} - \Delta h_e) \\ -h_{21e} & h_{22e} \end{pmatrix}$$

$$\begin{pmatrix} h_{11e} & h_{12e} \\ h_{21e} & h_{22e} \end{pmatrix} = \frac{1}{1 + h_{21b} - h_{12b} + \Delta h_b} \begin{pmatrix} h_{11b} & -(h_{12b} - \Delta h_b) \\ -(h_{21b} + \Delta h_b) & h_{22b} \end{pmatrix}$$

$$\begin{pmatrix} h_{11e} & h_{12e} \\ h_{21e} & h_{22e} \end{pmatrix} \approx \frac{1}{1 + h_{21b}} \begin{pmatrix} h_{11b} & -(h_{12b} - \Delta h_b) \\ -h_{21b} & h_{22b} \end{pmatrix}$$

$$\Delta h = h_{11} \cdot h_{22} - h_{12} \cdot h_{21}$$

Description of the transistor by y parameters in the RF range

The y or admittance parameters are generally specified as complex values.

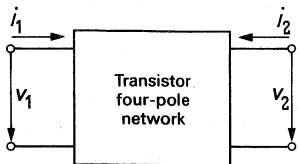

$$i_1 = y_{11} \cdot v_1 + y_{12} \cdot v_2$$

$$i_2 = y_{21} \cdot v_1 + y_{22} \cdot v_2$$

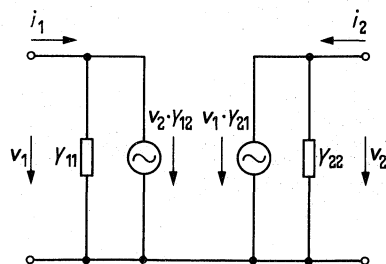

$$Y_{11} = g_{11} + jb_{11} = \left(\frac{i_1}{v_1} \right)_{v_2=0}$$

Short-circuit
input admittance

$$Y_{12} = g_{12} + jb_{12} = \left(\frac{i_1}{v_2} \right)_{v_1=0}$$

Short-circuit
reverse transfer admittance

$$Y_{21} = g_{21} + jb_{21} = \left(\frac{i_2}{v_1} \right)_{v_2=0}$$

Short-circuit
forward transfer admittance

$$Y_{22} = g_{22} + jb_{22} = \left(\frac{i_2}{v_2} \right)_{v_1=0}$$

Short-circuit
output admittance

Relation between the y parameters in common base and common emitter configurations

$$\begin{pmatrix} Y_{11b} & Y_{12b} \\ Y_{21b} & Y_{22b} \end{pmatrix} = \begin{pmatrix} Y_{11e} + Y_{12e} + Y_{21e} + Y_{22e} & -(Y_{12e} + Y_{22e}) \\ -(Y_{21e} + Y_{22e}) & Y_{22e} \end{pmatrix}$$

$$\begin{pmatrix} Y_{11e} & Y_{12e} \\ Y_{21e} & Y_{22e} \end{pmatrix} = \begin{pmatrix} Y_{11b} + Y_{12b} + Y_{21b} + Y_{22b} & -(Y_{12b} + Y_{22b}) \\ -(Y_{21b} + Y_{22b}) & Y_{22b} \end{pmatrix}$$

Calculation hints if h or y parameters are applied.
(There are solely real values in the equations for h parameters).

Relation between the h and y parameters

$$h_{11} = \frac{1}{Y_{11}} \quad h_{21} = \frac{Y_{21}}{Y_{11}} \quad Y_{11} = \frac{1}{h_{11}} \quad Y_{21} = \frac{h_{21}}{h_{11}}$$

$$h_{12} = -\frac{Y_{12}}{Y_{11}} \quad h_{22} = \frac{\Delta Y}{Y_{11}} \quad Y_{12} = -\frac{h_{12}}{h_{11}} \quad Y_{22} = \frac{\Delta h}{h_{11}}$$

$$\Delta h = h_{11} \cdot h_{22} - h_{12} \cdot h_{21} = \frac{Y_{22}}{Y_{11}} \quad \Delta Y = Y_{11} \cdot Y_{22} - Y_{12} \cdot Y_{21} = \frac{h_{22}}{h_{11}}$$

$$V_1 = V_0 - i_1 \cdot Z_G$$

$$V_2 = -i_2 \cdot Z_L$$

$$Z = R + jX$$

$$y = G + jB$$

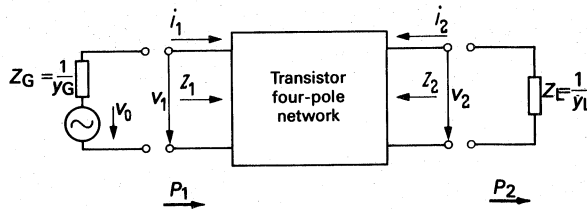

Input impedance

$$Z_1 = \frac{1}{Y_1} = \frac{v_1}{i_1} = \frac{h_{11} + \Delta h \cdot R_L}{1 + h_{22} \cdot R_L} = \frac{Y_L + Y_{22}}{Y_L Y_{11} + \Delta Y}$$

Output impedance

$$Z_2 = \frac{1}{Y_2} = \frac{v_2}{i_2} = \frac{h_{11} + R_G}{\Delta h + h_{22} \cdot R_G} = \frac{Y_G + y_{11}}{Y_G Y_{22} + \Delta Y}$$

Current gain

$$G_i = \frac{i_2}{i_1} = \frac{h_{21}}{1 + h_{22} \cdot R_L} = \frac{y_{21} Y_L}{Y_L Y_{11} + \Delta Y}$$

Voltage gain

$$G_v = \frac{v_2}{v_1} = \frac{-h_{21} \cdot R_L}{h_{11} + \Delta h \cdot R_L} = \frac{-y_{21}}{Y_L + Y_{22}}$$

Power gain (amplification not dependent on the generator resistance)

$$g_P = \frac{P_2}{P_1} = |G_V|^2 \cdot \frac{G_L}{G_1} = \frac{h_{21}^2 \cdot R_L}{(1 + h_{22} \cdot R_L)(h_{11} + \Delta h \cdot R_L)} = \frac{|y_{21}|^2 \cdot G_L}{\operatorname{Re} \{ (Y_L \cdot y_{11} + \Delta y)(Y_L^* + y_{22}^*) \}}$$

Power gain referred to the generator performance available (the data sheet specification G_p is generally based on this definition)

$$G_P = \frac{P_2}{P_{\text{Gopt}}} = \frac{4 \cdot h_{21}^2 \cdot R_G \cdot R_L}{P_{\text{Gopt}} [(1 + h_{22} \cdot R_L)(h_{11} + R_G) - h_{12} \cdot h_{21} \cdot R_L]^2} = \frac{4 |y_{21}|^2 \cdot G_G \cdot G_L}{[(Y_G + y_{11})(Y_L + y_{22}) - y_{12} \cdot y_{21}]^2}$$

With adaptation at input and output, i.e. with $Z_g = Z_1^*$, $Z_L = Z_2^*$, an ideal power gain can only be achieved if the stability conditions are observed

$$1 - \operatorname{Re} \left\{ \frac{y_{12} \cdot y_{21}}{g_{11} \cdot g_{22}} \right\} \frac{1}{4} \cdot \left(I_m \left\{ \frac{y_{12} \cdot y_{21}}{g_{11} \cdot g_{22}} \right\} \right)^2 > 0; \Delta h > 0 \text{ (every } h \text{ is real)}$$

In a (supposed) case without feedback $h_{12} = 0$; $y_{12} = 0$, G_{popt} is calculated:

$$G_{\text{popt}} = \frac{h_{21}^2}{4 \cdot h_{11} \cdot h_{22}} = \frac{|y_{21}|^2}{4 \cdot g_{11} \cdot g_{22}}$$

In the case of neutralization, the values h'_{ik} , y'_{ik} , modified by the neutralization four-pole network have to be applied.

Description of the transistor by S parameters in the RF range

The S or scattering parameters are specified as complex values and referred to the characteristic impedance Z_0 .

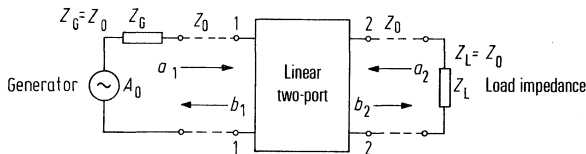

$$\begin{aligned} b_1 &= s_{11} a_1 + s_{12} a_2 \\ b_2 &= s_{21} a_1 + s_{22} a_2 \\ a_{1,2} &\text{ Ingoing waves} \\ b_{1,2} &\text{ Outgoing waves} \end{aligned}$$

$$s_{12} = S_{12} e^{j\varphi_{21}} = \left(\frac{b_1}{a_2} \right)_{a_1=0} \quad \text{Input reflection factor}$$

$$s_{11} = S_{11} e^{j\varphi_{11}} = \left(\frac{b_1}{a_1} \right)_{a_2=0} \quad \text{Reverse transfer factor}$$

$$s_{21} = S_{21} e^{j\varphi_{21}} = \left(\frac{b_2}{a_1} \right)_{a_2=0} \quad \text{Forward transfer factor}$$

$$s_{22} = S_{22} e^{j\varphi_{22}} = \left(\frac{b_2}{a_2} \right)_{a_1=0} \quad \text{Output reflection factor}$$

$$\Delta s = D = s_{11} s_{22} - s_{12} s_{21}$$

Calculation hints if S parameters are applied

Input reflection factor at any output Z_L $s'_{11} = s_{11} + \frac{s_{12} s_{21} \Gamma_L}{1 - s_{22} \Gamma_L}$

Output reflection factor at any output Z_G $s'_{22} = s_{22} + \frac{s_{12} s_{21} \Gamma_G}{1 - s_{11} \Gamma_G}$

Reflection factors of Z_G, Z_L referred to Z_0 Γ_G, Γ_L

Voltage gain at any output Z_G, Z_L $G_v = \frac{V_2}{V_1} = \frac{s_{21} (1 + \Gamma_L)}{(1 - s_{22} \Gamma_L) (1 + s_{11})}$

Power gain $G_p = \frac{P_2}{P_1} = \frac{|s_{21}|^2 (1 - |\Gamma_L|^2)}{(1 - |s_{11}|^2) + \frac{|s_{21}|^2 (1 - |\Gamma_L|^2)}{|s_{22}|^2 (1 - |D|^2) - 2 \operatorname{Re} \{ \Gamma_L N \}}$

Power gain referred to the generator performance available $G_p = \frac{P_2}{P_{Gopt}} = \frac{|s_{21}|^2 (1 - |\Gamma_S|^2) (1 - |\Gamma_L|^2)}{|(1 - s_{11} \Gamma_S) (1 - s_{22} \Gamma_L) - s_{12} s_{21} \Gamma_L \Gamma_S|^2}$

Stability factor

Maximum power gain available ($K > 1$)

$$K = \frac{1 + |D|^2 - |s_{11}|^2 - |s_{22}|^2}{2 |s_{12} s_{21}|}$$

$G_{pmax} = \frac{s_{21}}{s_{12}} (K + \sqrt{K^2 - 1})$ for positive h_{FE1}

$G_{pmax} = \frac{s_{21}}{s_{12}} (K - \sqrt{K^2 - 1})$ for negative h_{FE2}

whereby $\left[\begin{array}{l} \Gamma_G = M^* \frac{h_{FE1} \pm \sqrt{h_{FE1}^2 - 4M^2}}{2 |M|^2} \\ \Gamma_L = N^* \frac{h_{FE2} \pm \sqrt{h_{FE2}^2 - 4|N|^2}}{2 |N|^2} \end{array} \right]$

$h_{FE1} = 1 + \left| \frac{s_{11}}{s_{22}} \right| \frac{2 - \left| \frac{s_{22}}{s_{11}} \right| \frac{|D|^2}{|D|^2}}$
 $h_{FE2} = 1 + \left| \frac{s_{11}}{s_{22}} \right| \frac{2 - \left| \frac{s_{22}}{s_{11}} \right| \frac{|D|^2}{|D|^2}}$

$M = s_{11} - D s_{22}^*$
 $N = s_{22} - D s_{11}^*$

Unilateral power gain ($s_{12} = 0$)

$G_{pV} = G_{p0} \cdot G_{p1} \cdot G_{p2}$; $G_{p0} = |s_{21}|^2$; $G_{p1} = \frac{1 - |\Gamma_G|^2}{|1 - s_{11} \Gamma_G|^2}$; $G_{p2} = \frac{1 - |\Gamma_L|^2}{|1 - s_{22} \Gamma_L|^2}$

Ideal power gain ($s_{12} = 0$; adaptation

$G_{popt} = G_{p0} \cdot G_{p1max} \cdot G_{p2max}$, where $\Gamma_G = s_{11}^*$, $\Gamma_L = s_{22}^*$ $= \frac{|s_{21}|^2}{|(1 - |s_{11}|^2) (1 - |s_{22}|^2)|^2}$

Relation between the S and y parameters

$s_{11} = \frac{(1 - y'_{11}) (1 + y'_{22}) + y'_{12} y'_{21}}{(1 + y'_{11}) (1 + y'_{22}) - y'_{12} y'_{21}}$

$y'_{11} = \frac{(1 + s_{22}) (1 - s_{11}) + s_{12} s_{21}}{(1 + s_{11}) (1 + s_{22}) - s_{12} s_{21}}$

$s_{12} = \frac{-2 y'_{12}}{(1 + y'_{11}) (1 + y'_{22}) - y'_{12} y'_{21}}$

$y'_{12} = \frac{-2 s_{12}}{(1 + s_{11}) (1 + s_{22}) - s_{12} s_{21}}$

$s_{21} = \frac{-2 y'_{21}}{(1 + y'_{11}) (1 + y'_{22}) - y'_{12} y'_{21}}$

$y'_{21} = \frac{-2 s_{21}}{(1 + s_{11}) (1 + s_{22}) - s_{12} s_{21}}$

$s_{22} = \frac{(1 + y'_{11}) (1 - y'_{22}) + y'_{12} y'_{21}}{(1 + y'_{11}) (1 + y'_{22}) - y'_{12} y'_{21}}$

$y'_{22} = \frac{(1 + s_{11}) (1 - s_{22}) + s_{12} s_{21}}{(1 + s_{22}) (1 + s_{11}) - s_{12} s_{21}}$

The y parameters of these equations are standardized to Z_0

The actual values $y_{ik} = y'_{ik} \cdot Z_0$; $i, k = 1, 2$

Relation between the S parameters and the h parameters

$$s_{11} = \frac{(h'_{11}-1)(h'_{22}+1) - h'_{12}h'_{21}}{(h'_{11}+1)(h'_{22}+1) + h'_{12}h'_{21}}$$

$$h'_{11} = \frac{(1+s_{11})(1+s_{22}) - s_{12}s_{21}}{(1-s_{11})(1+s_{22}) + s_{12}s_{21}}$$

$$s_{12} = \frac{2h'_{12}}{(h'_{11}+1)(h'_{22}+1) + h'_{12}h'_{21}}$$

$$h'_{12} = \frac{2s_{12}}{(1-s_{11})(1+s_{22}) + s_{12}s_{21}}$$

$$s_{21} = \frac{-2h'_{21}}{(h'_{11}+1)(h'_{22}+1) + h'_{12}h'_{21}}$$

$$h'_{11} = \frac{-2s_{21}}{(1-s_{11})(1+s_{22}) + s_{12}s_{21}}$$

$$s_{22} = \frac{(1+h'_{11})(1-h'_{22}) + h'_{12}h'_{21}}{(h'_{11}+1)(h'_{22}+1) - h'_{12}h'_{21}}$$

$$h'_{22} = \frac{(1-s_{22})(1-s_{11}) - s_{12}s_{21}}{(1-s_{11})(1+s_{22}) + s_{12}s_{21}}$$

The h parameters of these equations are standardized to Z_0

The true values h are:

$$h_{11} = h'_{11} Z_0; \quad h_{12} = h'_{12}; \quad h_{21} = h'_{21}; \quad h_{22} = \frac{h'_{22}}{Z_0}$$

Physical equivalent circuits of transistors

Apart from describing the characteristics of a transistor by means of four-pole parameters (formal equivalent circuits), it is also possible to use an illustration in the form of so-called physical equivalent circuits. Elements of these equivalent circuits are sometimes mentioned in the characteristic data.

π -equivalent circuit of a transistor (according to Giacoletto; common emitter configuration)

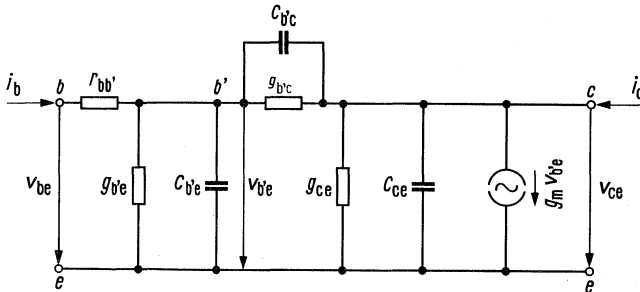

Approximately applies

$$g_{b'e} = \frac{1}{r_e \beta_0}$$

$$C_{b'e} = \frac{1}{r_e 2\pi f_T}$$

$$g_m = 1/r_e$$

$$g_{b'c} \text{ and } g_{ce} \approx \sigma$$

$$r_e = V_T / I_E$$

$$V_T = 26 \text{ mV}$$

Relation between the y parameters and the elements of the π -equivalent circuits

$$\begin{pmatrix} Y_{11e} & Y_{12e} \\ Y_{21} & Y_{22e} \end{pmatrix} = \frac{1}{M} \begin{pmatrix} Y_{b'c} + Y_{b'e} & -Y_{b'c} \\ g_m - Y_{b'c} & (Y_{b'c} + Y_{ce}) M + r_{bb'} Y_{b'c} (g_m - Y_{b'c}) \end{pmatrix}$$

$$Y_{b'c} = g_{b'c} + j\omega C_{b'c}$$

$$Y_{ce} = g_{ce} + j\omega C_{ce}$$

$$Y_{b'e} = g_{b'e} + j\omega C_{b'e}$$

$$M = 1 + (Y_{b'c} + Y_{b'e}) r_{bb'}$$

Radio frequency T equivalent circuit of a transistor (common base configuration)

This equivalent circuit is not suitable for application in the AF range

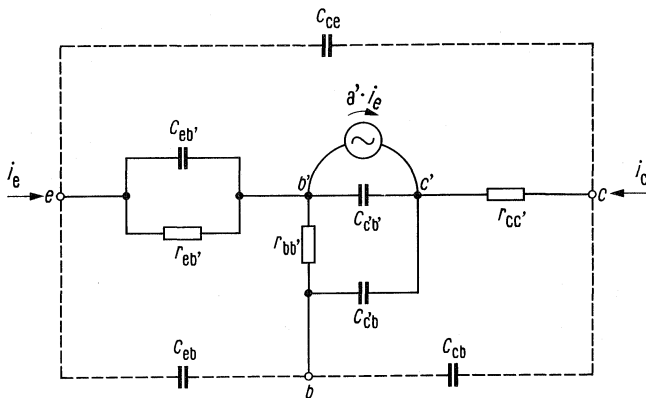

2.5. Quality Data on the Components

Siemens releases a production lot on discrete components only after a hundred percent examination and an additional random sampling test have been carried out. The slipping through of defective components is statistically mentioned by the so-called AQL figures (acceptable quality level). Should, however, the applicator make a random sampling test as well, then the following random sampling test plans are recommended in connection with which the acceptance characteristics must be considered in relation to the random sample amount:

Mil Std 105 D, DIN 40080

In order to classify the quality of semiconductor devices in the data sheets, the following indications have been made for industrial types:

a) Maximum ratings, as well as maximum and minimum scattering values in the case of characteristics.

b) AQL figures, i.e. maximum share of defective components, for the values mentioned in a).

The principles of statistics have to be considered when judging the quality of delivery.

The delivery quality is specified by the AQL figure as follows:

Standard types		Industrial types		Max. possible defects
Defect type		Defect type		
Defects in packages and leads	AQL	Electrical defects	AQL	Σ AQL
Hundred percent defect	0.25	Hundred percent defect	0.25	0.25
Major defect	1.5	Major defect	0.65	1.5
Minor defect	2.5	Minor defect	1.5	2.5

Definition of the defects

For each defect class, for which an AQL figure has been determined, only the number of defective units (defective in respect of one or more characteristics within this defect class) is taken into account, i. e. a defective component is valued only once.

Hundred percent defects (decisive defects)

If such a defect is present, any functional application of the component is considerably effected or impossible. Origins can lie in broken leads or packages, false or missing type marking, bad cracks and voids, contact break, or short circuits, as well as rough discrepancy in characteristics.

Major defects

The serviceability of the component is noticeably impaired.

Minor defects

The component is entirely operable. Such defects are e.g. slightly bent terminals, minor damage to the package, marking difficult to identify, or unimportant exceeding of dynamical or optical characteristics.

Hints for the random sampling test

If a random sampling test in accordance with DIN 40080 with the main test level II for a lot amount of 3200 to 10000 units is carried out, the characteristic letter L with a random sample amount of 200 units will result. The permissible defects can be quoted from table II A (see page 59).

Since canceled lots must be measured again very precisely, the rejection share after the hundred percent test must be kept as low as possible.

Hence, the actual defect portion of the supplied goods lies considerably below the AQL figures stated in our data sheets.

Characteristic letters

Table I Characteristic letters for the random sample size

Lot or batch size	Special test levels				Main test levels		
	S-1	S-2	S-3	S-4	I	II	III
2 to 8	A	A	A	A	A	A	B
9 to 15	A	A	A	A	A	B	C
16 to 25	A	A	B	B	B	C	D
26 to 50	A	B	B	C	C	D	E
51 to 90	B	B	C	C	C	E	F
91 to 150	B	B	C	D	D	F	G
151 to 280	B	C	D	E	E	G	H
281 to 500	B	C	D	E	F	H	J
501 to 200	C	C	E	F	G	J	K
1201 to 3200	C	D	E	G	J	K	L
3201 to 10000	C	D	F	G	J	L	M
10001 to 35000	C	D	F	H	K	M	N
35001 to 150000	D	E	G	J	L	M	P
150001 to 500000	D	E	G	J	M	P	Q
500001 and more	D	E	H	K	N	Q	R

Table II-A Simple random sampling test plan for normal test (guiding table)

Characteristic letter	Sample size		Acceptable quality limits (normal test)																										
	c	d	0.010	0.015	0.025	0.040	0.065	0.10	0.15	0.25	0.40	0.65	1.0	1.5	2.5	4.0	6.5	10	15	25	40	65	100	150	250	400	650	1000	
A	2	1	→	→	→	→	→	→	→	→	→	→	→	→	→	→	→	→	→	→	→	→	→	→	→	→	→	→	→
B	3	2	→	→	→	→	→	→	→	→	→	→	→	→	→	→	→	→	→	→	→	→	→	→	→	→	→	→	→
C	5	4	→	→	→	→	→	→	→	→	→	→	→	→	→	→	→	→	→	→	→	→	→	→	→	→	→	→	→
D	8	7	→	→	→	→	→	→	→	→	→	→	→	→	→	→	→	→	→	→	→	→	→	→	→	→	→	→	→
E	13	12	→	→	→	→	→	→	→	→	→	→	→	→	→	→	→	→	→	→	→	→	→	→	→	→	→	→	→
F	20	19	→	→	→	→	→	→	→	→	→	→	→	→	→	→	→	→	→	→	→	→	→	→	→	→	→	→	→
G	32	31	→	→	→	→	→	→	→	→	→	→	→	→	→	→	→	→	→	→	→	→	→	→	→	→	→	→	→
H	50	49	→	→	→	→	→	→	→	→	→	→	→	→	→	→	→	→	→	→	→	→	→	→	→	→	→	→	→
J	80	79	→	→	→	→	→	→	→	→	→	→	→	→	→	→	→	→	→	→	→	→	→	→	→	→	→	→	→
K	125	124	→	→	→	→	→	→	→	→	→	→	→	→	→	→	→	→	→	→	→	→	→	→	→	→	→	→	→
L	200	199	→	→	→	→	→	→	→	→	→	→	→	→	→	→	→	→	→	→	→	→	→	→	→	→	→	→	→
M	315	314	→	→	→	→	→	→	→	→	→	→	→	→	→	→	→	→	→	→	→	→	→	→	→	→	→	→	→
N	500	499	→	→	→	→	→	→	→	→	→	→	→	→	→	→	→	→	→	→	→	→	→	→	→	→	→	→	→
P	800	799	→	→	→	→	→	→	→	→	→	→	→	→	→	→	→	→	→	→	→	→	→	→	→	→	→	→	→
Q	1250	1249	→	→	→	→	→	→	→	→	→	→	→	→	→	→	→	→	→	→	→	→	→	→	→	→	→	→	→
R	2000	1999	→	→	→	→	→	→	→	→	→	→	→	→	→	→	→	→	→	→	→	→	→	→	→	→	→	→	→

Use the first pair of figures below the arrow. Should the sample size be larger, or equal to the lot or batch size, make 100% test.

Use the first pair of figures above the arrow.

c Number of acceptances

d Number of rejections

SIMPLE NORMAL

2.6 Mounting Instructions

General information

Each semiconductor component is extraordinarily sensitive to an exceeding of the maximum permissible junction temperature. When designing the devices, care must be taken that the distance between heat generators and semiconductors is large enough. If a preheating up to 75°C is applied, the soldering times have to be shortened by 30%.

Soldering instructions

Soldering specifications for plastic encapsulated components

Lead length L = ¹⁾	0.5	1.5	5	mm
Soldering temperature 245°C	4	5	10	s
Soldering temperature 260°C	3	5	5	s
Soldering temperature 300°C ²⁾	2.5	3	5	s

Soldering specifications for hermetically sealed components

Lead length L = ¹⁾	1.5	2.5	5	mm
Soldering temperature 245°C	5	6	13	s
Soldering temperature 260°C	3.5	4	10	s
Soldering temperature 300°C ²⁾	3	3.5	8	s

Mounting instructions

Transistors and diodes can be mounted in any position. The following points should be observed when bending the terminal strips:

1. For the bending process, the strips should be discharged between bending point and plastic case in order to avoid mechanical stress between case and connecting point.
2. When bending the leads vertically to the mounting plane, a minimum distance of once the terminal strip diagonal must be observed. Bending radius not below twice the terminal strip diagonal.
3. Bending in the mounting plane should be carried out with a minimum distance from the case of at least four times the terminal strip diagonal and a minimum bending radius of at least four times the terminal strip diagonal.
4. Avoid repeated bendings since the bending strength is limited to three bendings (90°).
5. Do not bend leads directly at the case, except in the case of version 50 B 3 (similar to TO 50).
6. The leads of the cases TO 126, TO 202, and TO 220 can only resist minor axial forces. Hence bending without a bending device is only permissible to a slight degree (approx 30°). The little flexible leads should therefore not be bent or twisted excessively. It is recommended to use a bending device or long-nose pliers, with the pliers held between case and bending point in order to stabilize the terminal strips. In this way, mechanical stress on the case is avoided.

1) The lead length is measured from the soldering point on, i.e. with normally clad plates from plate bottom on, and with through-plated holes from the plate top on. If the case won't be touched by the solder iron, a thyristor lead length of L = 0 is permissible. A special soldering instruction additionally applies to this case, as well as for thick and thin film circuit components (TO 236 etc.)

2) Only valid for iron soldering

Mounting and soldering instructions for transistors in plastic encapsulation, especially for types 12, A 3 DIN 41869 (TO 126) and 10 A 3 DIN 41868 (TO 92).

Mounting of TO 126 packages should be carried out by means of an M 3 screw with a starting torque minimum of 5 cm/kp, to a maximum of 8 cm/kp (corresponding to 50 to 80 cm N)

A washer, or better an A 3 DIN 137 spring washer is to be applied (ordering code Q 62902-B 63).

Insulation of TO 126 packages is feasible by means of a mica washer, 50 μm thick (Ordering code Q 62902-B 62). In the case of a dry washer, the thermal resistance is increased by 8 K/W, and with a washer greased with thermally conductive paste by 4 K/W.

Too large holes for mounting (larger than 3.5 \varnothing), as well as axial forces on the leads during mounting are to be avoided.

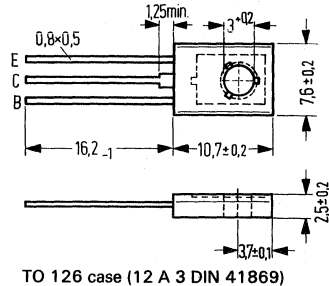

TO 126 case (12 A 3 DIN 41869)

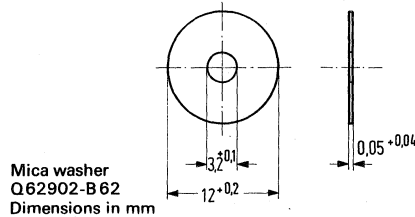

Mica washer
Q 62902-B 62
Dimensions in mm

Soldering instruction for semiconductors in TO 236 (similar to SOT 89) plastic packages

Semiconductors in SOT 23 packages are intended to be used as active components in thin and thick film circuits. The specified soldering instructions are based on the application of substrates with resistors and conductor paths, with the conductor paths being dip-soldered with a tin-lead coating.

The following points are to be observed for obtaining a reliable connection:

1. Important are the right soldering temperature and the suitable flux. The flux must not attack the resistors and an easy removal of its remainder from the substrate has to be provided.
2. In order to avoid broken substrates and cracks, the temperature (max. 240°C during max. 5 s) and the temperature change during soldering may not exert high mechanical stress on the substrate.
3. The semiconductors must be mounted on the substrate with the utmost precision. It must be achieved that the terminals lie exactly on the conductor paths, as there is a high danger in cracks originating at areas where the heated terminals directly touched the substrate.

The selection of the soldering mode is determined by the series size, the number of semiconductor units per circuit, the required mounting precision, and by the possibility of exchanging semiconductor components.

The most important mounting methods are as follows:

Method 1: Flow soldering

The components in the SOT 23 case are stuck onto the thick film substrate (glass, ceramic) or onto the etched PCB (glass fiber) by a silicone adhesive. The adhesive can be applied by means of silk screening. With this process, care must be taken of the contacting areas not to be covered by the adhesive.

The components are pressed onto the substrate. An excellent adherence is ensured by a glue depth of 60 to 80 μm , and this amount will also not contaminate the contacting areas while contacting pressure is applied. Soldering can be effected by flow or dip soldering. An Sn-Po alloy next to the eutecticum with an Ag additive of 3.5 to 4% has proved successful as a solder (e.g. Soldamo/ 170 Sn/Pb/Ag: 60/35/4). The solder bath temperature should amount to $225 \pm 10^\circ\text{C}$; a maximum soldering time of 5 sec. is permitted. An non-activated 45% resin dissolved in a 55% ethyl alcohol with glycerin additive is a suitable flux. The flux remainders should be removed after the components have been soldered. Cleaning baths containing isopropyl alcohol are suitable for this process.

Method 2: Reflow soldering

The solder powder together with a flux are applied as paste onto the PCB. This process is appropriately carried out with silk screening. The coating thickness should thereby amount to approximately 80 μm .

The soldering process is caused by heating the substrate with the components for 5 sec. up to 240°C by means of a heating plate or conveyor belt, and this results in the paste's melting. Further details can be quoted from the instructions of reflow soldering paste manufacturers.

Method 3: Needle soldering

The substrate is arranged on a preheating plate with a temperature of approx. 100°C . The semiconductor is illustrated optically enlarged and put into the right position. The component is picked up by means of a partial vacuum nozzle and placed on the substrate. Simultaneously three other (still cold) micro soldering needles are set onto the terminals and pressed down in order to improve the heat transition. The soldering needles must have been constructed such that the heat transition is effected only at the top of them. For a short time (8 sec.) the needles are supplied with 20 W, each. Within this period the solder is liquid for 3 sec., thus obtaining a reliable wetting. Owing to the low heat capacity, the soldering needles are cooling down very quickly after they have been disconnected. Hence, the solder can cool down to values far below the melting point with applied soldering needles. Refined steel (18% G, 8% Ni) should be used as material for soldering needles. This kind of material will not be covered by the solder and has a good corrosion resistance. Colophony would be a suitable flux. After soldering the flux remainders have to be removed by isopropyl alcohol.

If using this procedure, the case won't grow hotter than the preheating plate. If the preheating plate is not heated over 100°C and the soldering time of 5 sec. isn't surpassed, the danger of substrate cracks below the conductor paths won't be that large anymore. When using this method, the junction temperature will rise up to approx. 250°C .

This kind procedure is also suitable for exchanging individual semiconductors.

Method 4: Iron soldering

The fourth method in question is manual soldering by means of a miniature soldering iron. This kind of soldering has the following disadvantages:

The semiconductor cannot be placed with a very high degree of precision, i.e. during soldering there is the possibility that substrate cracks occur at areas where the substrate is directly touched by the terminals. Since soldering of the terminals is carried out one after another, substrate breaking can happen due to mechanical stress, or contacts within the semiconductor units can also be damaged. It is possible to damage the plastic package with the soldering iron.

This soldering method is only suitable for mounting individual components.

3. Data Sheets

for AF, driver and output stages of medium performance

AC 121 and AC 152 are alloyed germanium PNP transistors in 1 A 3 DIN 41871 metal case (similar to TO 1).

The leads of these transistors are electrically insulated from the case. The collector terminal is marked by a red dot at the rim of the case. For use in push-pull output stages, the transistors AC 121 and AC 152 are available in pairs. A fixing part (heat sink¹⁾) is provided for fixing on the chassis; it has to be ordered separately.

Not for new design

Type	Ordering code	Type	Ordering code
AC 121 IV	Q60103-D121	AC 152 IV	Q60103-X152-D
AC 121 V	Q60103-E121	AC 152 V	Q60103-X152-E
AC 121 VI	Q60103-F121	AC 152 VI	Q60103-X152-F
AC 121 VII	Q60103-G121	AC 152 paired	Q60103-X152-P
AC 121 paired	Q60103-P121-X1	Heat sink	Q62901-B1

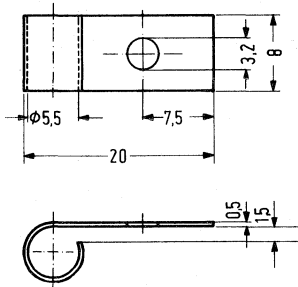

Approx. weight 2 g

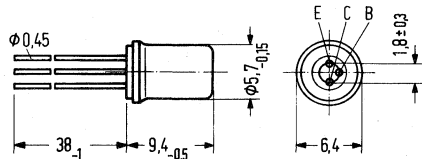

Approx. weight 1 g

Dimensions in mm

Maximum ratings

Collector-emitter voltage
 Collector-emitter voltage ($V_{BE} \geq 0.2$ V)
 Collector-base voltage
 Emitter-base voltage
 Collector current
 Base current
 Junction temperature
 Storage temperature range
 Total power dissipation

	AC 121	AC 152	
$-V_{CEO}$	20	24	V
$-V_{CEV}$	20	32	V
$-V_{CBO}$	20	32	V
$-V_{EBO}$	10	10	V
$-I_C$	300	500	mA
$-I_B$	60	100	mA
T_j	90	90	°C
T_{stg}	-55 to +75		°C
P_{tot}	900	900	mW

Thermal resistance

Junction to ambient air
 Junction to case

	AC 121	AC 152	
R_{thJA}	≤ 300	≤ 300	K/W
R_{thJC}	≤ 50	≤ 50	K/W

1) Thermal resistance between transistor case and heat sink below the fixing screw at careful mounting: $R_{th} \leq 10$ K/W

Static characteristics ($T_{amb} = 25^{\circ}\text{C}$)

The transistors AC 121, AC 152 are grouped according to the DC current gain h_{FE} at $-I_C = 100$ mA, and marked by the Roman numerals. The following values apply at a collector voltage of $-V_{CE} = 0.5$ V and the following collector currents:

h_{FE} group		IV	V	VI	VII	
		AC 152	AC 152	AC 152	–	AC 152
Type		AC 121	AC 121	AC 121	AC 121	AC 121
$-I_C$ mA	$-I_C$ mA	h_{FE} I_C/I_B	h_{FE} I_C/I_B	h_{FE} I_C/I_B	h_{FE} I_C/I_B	$-V_{BE}$ V
[2]	3	48 [47]	80 [78]	115 [114]	200	0.13 (<0.22)
100	100	45 (30 to 60)	75 (50 to 100)	110 (75 to 150)	190 (125 to 250)	0.32 (<0.55)
[500]	300	35 [28]	58 [47]	86 [68]	148	0.44 (<0.8) [0.52 (<1.0)]

Static characteristics ($T_{amb} = 25^{\circ}\text{C}$)

Collector-emitter saturation voltage

($-I_C = 100$ mA; $h_{FE} = 20$)

Collector-emitter saturation voltage

($-I_C = 300$ mA; $h_{FE} = 20$)

Collector-emitter saturation voltage

Emitter cutoff current ($-V_{EBO} = 10$ V)

Collector cutoff current ($-V_{CBO} = 20$ V)

Collector cutoff current

($-V_{CEV} = 20$ V; $V_{BE} \geq 0.2$ V)

	AC 121	
$-V_{CEsat}^1$	0.11 (<0.3)	V
$-V_{CEsat}^1$	0.15 (<0.35)	V
$-V_{CEsat}$	0.28 (<0.45) ²⁾	V
$-I_{EBO}$	4 (<25)	μA
$-I_{CBO}$	5 (<25)	μA
$-I_{CEV}$	5 (<25)	μA

Collector-emitter saturation voltage

($-I_C = 100$ mA; $h_{FE} = 20$)

Collector-emitter saturation voltage

($-I_C = 300$ mA; $h_{FE} = 20$)

Collector-emitter saturation voltage

Collector cutoff current ($-V_{CBO} = 32$ V)

Collector cutoff current ($-V_{CEV} = 32$ V);
($V_{BE} = 0.2$ V)

Emitter cutoff current ($V_{EBO} = 10$ V)

	AC 152	
$-V_{CEsat}^1$	0.11 (<0.18)	V
$-V_{CEsat}^1$	0.15 (<0.25)	V
$-V_{CEsat}$	0.32 (<0.5) ²⁾	V
$-I_{CBO}$	6 (<25)	μA
$-I_{CEV}$	6 (<25)	μA
$-I_{EBO}$	4 (<25)	μA

1) The transistor is overloaded to such a degree that the DC current gain decreases to $h_{FE} = 20$.

2) ($-I_C = 500$ mA for the characteristic which, at a constant base current, intersects the operating point, where $-I_C = 550$ mA; $-V_{CE} = 0.5$ V)

Condition for matching pairs: AC 152/AC 152

($-I_C = 100 \text{ mA}$; $-V_{CE} = 0.5 \text{ V}$)

ΔV_{BE}	< 35	mV
h_{FE1}	1.25	-

Condition for matching pairs: AC 127/AC 152

($\pm I_C = 300 \text{ mA}$; $V_{CB} = 0$)

ΔV_{BE}	< 35	mV
h_{FE1}	< 1.25	-
h_{FE2}		

Condition for matching pairs: AC 121/AC 121

($-I_C = 300 \text{ mA}$; $-V_{CE} = 0.5 \text{ V}$)

ΔV_{BE}	< 35	mV
h_{FE1}	< 1.25	-
h_{FE2}		

Dynamic characteristics ($T_{amb} = 25^\circ\text{C}$)

Cutoff frequency

($-I_C = 20 \text{ mA}$; $-V_{CE} = 5 \text{ V}$)

Transition frequency

Base intrinsic resistance

Collector-base capacitance ($-V_{CBO} = 5 \text{ V}$)

	AC 121	
f_{hfe}	17	kHz
f_T	1.5	MHz
$r_{bb'}$	60	Ω
C_{CBO}	25 (<40)	pF

Cutoff frequency

($-I_C = 5 \text{ mA}$; $-V_{CE} = 5 \text{ V}$)

Transition frequency

Base intrinsic resistance

Collector-base capacitance ($-V_{CBO} = 5 \text{ V}$)

	AC 152	
f_{hfe}	15	kHz
f_T	1.5	MHz
$r_{bb'}$	75 (<200)	Ω
C_{CBO}	25 (<40)	pF

Total perm. power dissipation versus temperature
 $P_{tot} = f(T); R_{th} = \text{parameter}$

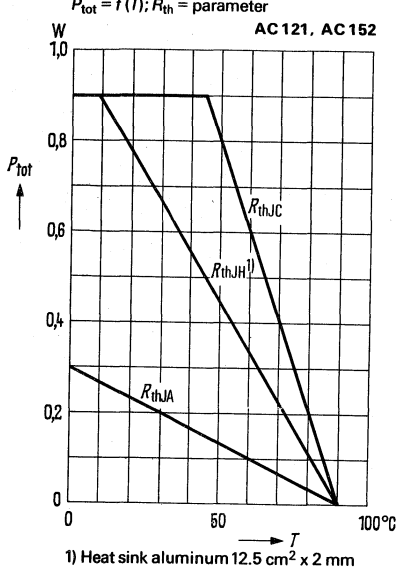

Permissible pulse load
 $r_{thJC} = f(t); v = \text{parameter}$

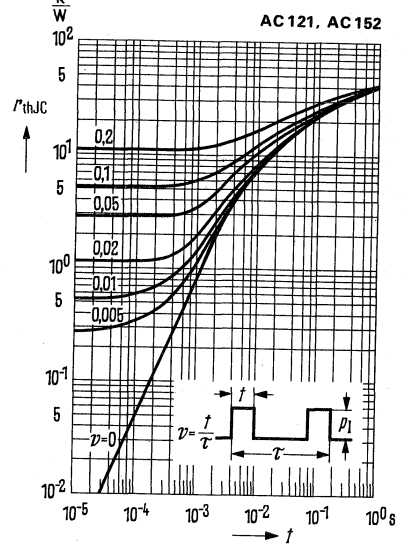

DC current gain $h_{FE} = f(I_C)$
 $-V_{CE} = 0.5 \text{ V}; T_{amb} = \text{parameter}$
 (common emitter configuration)

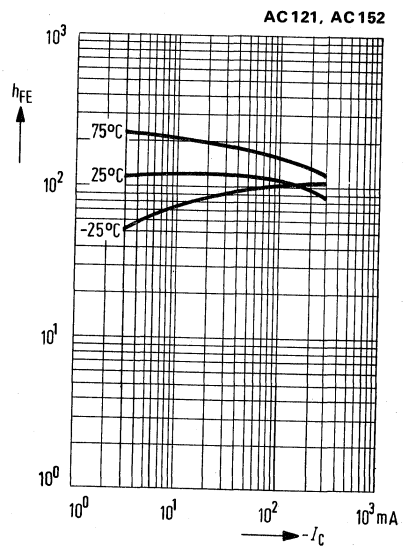

Collector current $I_C = f(V_{BE})$
 $-V_{CE} = 0.5\text{ V}; T_{amb} = \text{parameter}$
 (common emitter configuration)

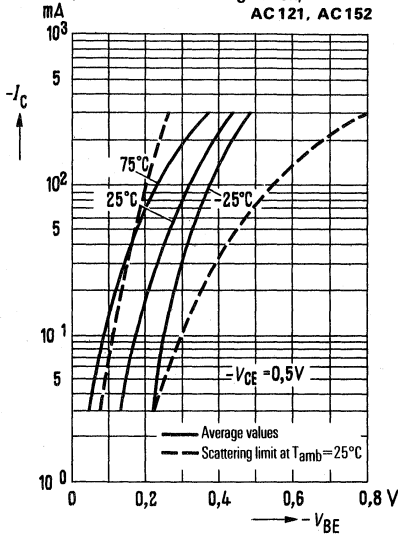

Input characteristics $I_B = f(V_{BE})$
 $-V_{CE} = 0.5\text{ V}; T_{amb} = \text{parameter}$
 (common emitter configuration)

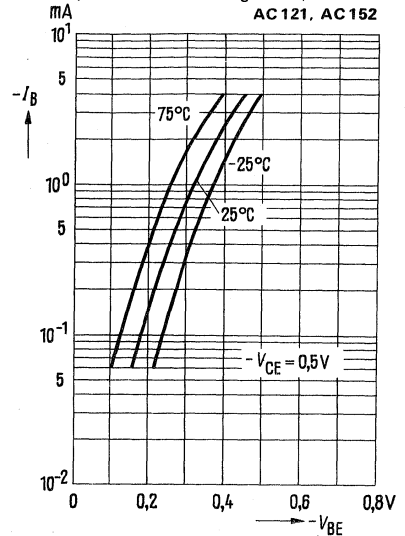

Output characteristics $I_C = f(V_{CE}); I_B = \text{parameter}$
 (common emitter configuration)

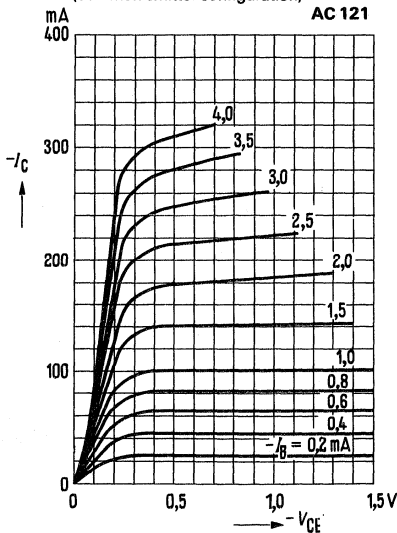

Output characteristics $I_C = f(V_{CE}); I_B = \text{parameter}$
 (common emitter configuration)

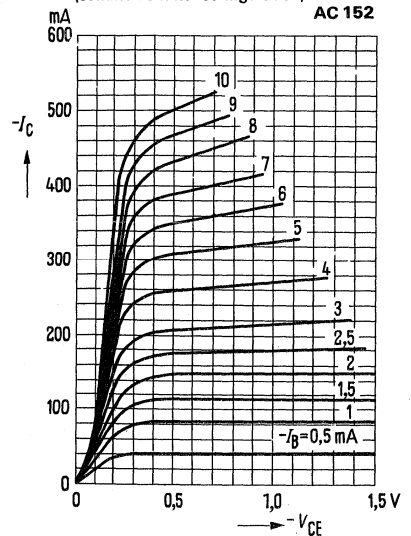

Output characteristics

$I_C = f(V_{CE})$; $V_{BE} = \text{parameter}$
(common emitter configuration)

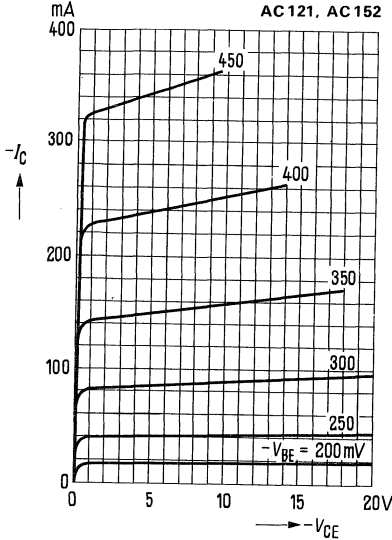

Collector emitter saturation voltage

$V_{CEsat} = f(I_C)$; $h_{FE} = 20$
(common emitter configuration)

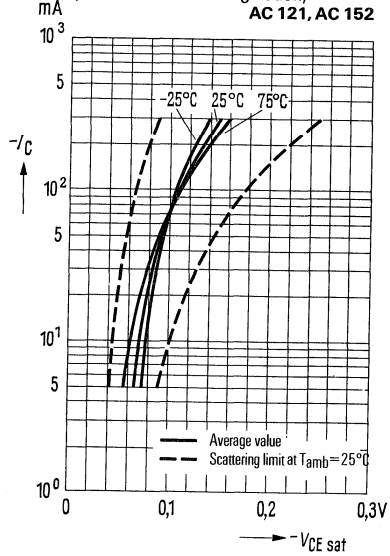

Collector cutoff current versus

temperature $I_{CBO} = f(T_{amb})$
For $V_{CE} = V_{CEmax}$

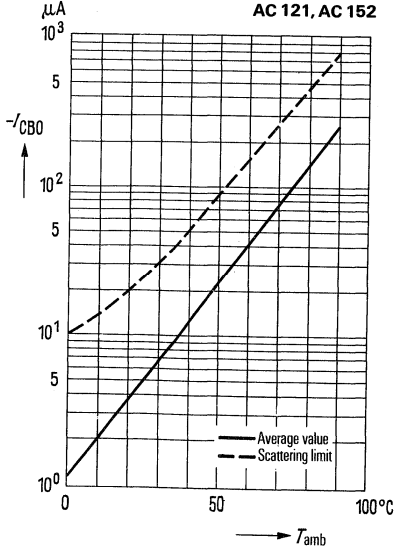

Collector-emitter voltage

$V_{CER} = f(R_{BE})$

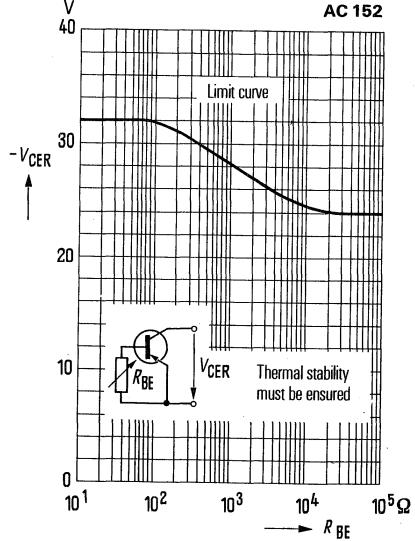

for AF input and driver stages of medium performance

AC 151 and AC 151 r are alloyed germanium PNP transistors in 1A 3 DIN 41871 case (similar to TO-1).

The leads of these transistors are electrically insulated from the case. The collector terminal is marked by a red dot at the rim of the case. A fixing part (heat sink¹⁾) is provided for fixing on the chassis; it has to be ordered separately.

Type	Ordering code
AC 151 IV	Q60103-X151-D
AC 151 rIV	Q60103-X151-D1
AC 151 V	Q60103-X151-E
AC 151 rV	Q60103-X151-E1
AC 151 VI	Q60103-X151-F
AC 151 rVI	Q60103-X151-F1
AC 151 VII	Q60103-X151-G
Heat sink	Q62901-B1

Not for new design

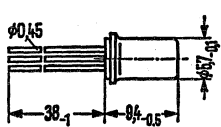

Approx. weight 1 g

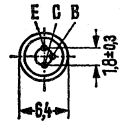

Dimensions in mm

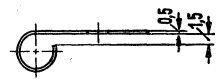
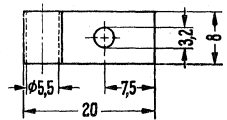

Approx. weight 2 g

Maximum ratings

- Collector-emitter voltage
- Collector-emitter voltage ($V_{BE} \geq 0.2$ V)
- Collector-base voltage
- Emitter-base voltage
- Collector current
- Base current
- Junction temperature
- Storage temperature range
- Total power dissipation

	AC 151	AC 151 r
$-V_{CEO}$	24	V
$-V_{CEV}$	32	V
$-V_{CBO}$	32	V
$-V_{EBO}$	10	V
$-I_C$	200	mA
$-I_B$	40	mA
T_j	90	°C
T_{stg}	-55 to +75	°C
P_{tot}	900	mW

Thermal resistance

- Junction to ambient air
- Junction to case

R_{thJA}	≤ 300	K/W
R_{thJC}	≤ 50	K/W

1) Thermal resistance between transistor case and heat sink below the fixing screw at careful mounting: $R_{th} \leq 10$ K/W

Static characteristics ($T_{amb} = 25^\circ\text{C}$)³⁾

	AC 151	AC 151 r	
Collector-emitter saturation voltage ($-I_C = 200\text{ mA}$; $h_{FE} = 20$)	$-V_{CEsat}^{1)}$	0.13 (<0.22)	V
Collector-emitter saturation voltage	$-V_{CEsat}$	0.25 (<0.4) ²⁾	V
Collector cutoff current ($V_{CBO} = 10\text{ V}$)	$-I_{CBO}$	< 10	μA
Collector cutoff current ($V_{CBO} = 32\text{ V}$)	$-I_{CBO}$	6 (<25)	μA
Collector cutoff current ($-V_{CEV} = 32\text{ V}$; $V_{BE} \geq 0.2\text{ V}$)	$-I_{CEV}$	6 (<25)	μA
Emitter cutoff current ($-V_{EBO} = 10\text{ V}$)	$-I_{EBO}$	4 (<25)	μA

Dynamic characteristics ($T_{amb} = 25^\circ\text{C}$)

	AC 151	AC 151r	
Cutoff frequency ($-I_C = 1\text{ mA}$; $-V_{CE} = 5\text{ V}$)	f_{hfe}	15	15 kHz
Transition frequency	f_T	1.5	1.5 MHz
Base intrinsic resistance	$r_{bb'}$	75	75 Ω
Collector-junction capacitance	$C_{b'e}$	27	27 pF
Noise figure ($-I_C = 0.5\text{ mA}$; $-V_{CE} = 5\text{ V}$; $f = 200\text{ Hz}$; $R_g = 500\text{ }\Omega$; $f = 1\text{ kHz}$)	NF	4 (<10)	3 (<6) dB

The transistors AC 151 and AC 151r are grouped according to the small signal current gain h_{fe} and marked by Roman numerals.

Operating point: ($-I_C = 2\text{ mA}$; $-V_{CE} = 1\text{ V}$; $f = 1\text{ kHz}$)

h_{fe} group	IV	V	VI	VII	
Type	AC 151 r	AC 151 r	AC 151 r	-	
	AC 151	AC 151	AC 151	AC 151	
h_{11e}	0.75 (0.4 to 1.3)	1.2 (0.6 to 2.1)	1.8 (1.0 to 3.2)	2.7 (1.7 to 5.3)	k Ω
h_{12e}	9 (<20)	13 (<25)	16 (<28)	19 (<30)	10 ⁻⁴
h_{21e}	45 (30 to 60)	75 (50 to 100)	110 (75 to 150)	170 (125 to 250)	-
h_{22e}	100 (<200)	140 (<250)	160 (<280)	160 (<300)	μS

1) The transistor is overloaded to such a degree that the DC current gain decreases to $h_{FE} = 20$.

2) ($-I_C = 200\text{ mA}$ for the characteristic which, at a constant base current, intersects the operating point, where $-I_C = 200\text{ mA}$; $-V_{CE} = 0.5\text{ V}$)

3) See also next page

Total perm. power dissipation versus temperature

$P_{tot} = f(T); R_{th} = \text{parameter}$

AC 151, AC 151 r

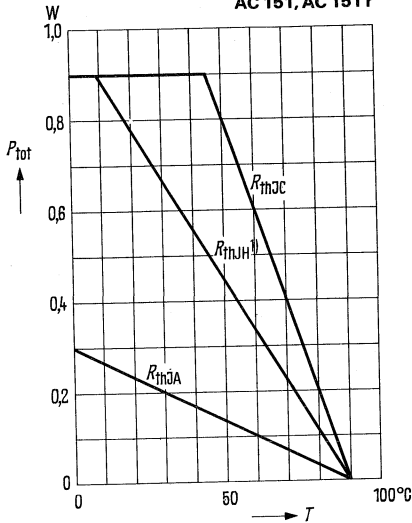

1) Heat sink: aluminum 12.5 cm² x 2 mm

Permissible pulse load

$r_{thJC} = f(t); v = \text{parameter}$

AC 151, AC 151 r

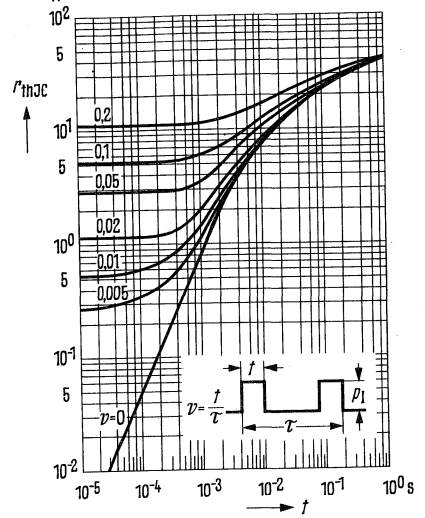

Static characteristics ($T_{amb} = 25^\circ\text{C}$)

$-V_{CE} = 0,5 \text{ V}$

Type	AC 151, 151 r		
$-I_C$ mA	$-I_B$ mA	h_{FE} I_C/I_B	$-V_{BE}$ V
2	0,043	47	0,125 (<0,2)
10	0,2	50	0,18 (<0,3)
50	-	-	-
100	2,222	45	0,32 (<0,55)
200	5	40	0,39 (<0,7)

DC current gain $h_{FE} = f(I_C)$

$-V_{CE} = 0,5 \text{ V}; T_{amb} = \text{parameter}$

(common emitter configuration)

AC 151, AC 151 r

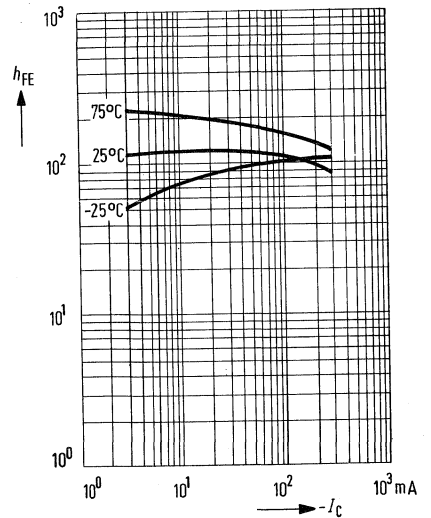

Collector current $I_C = f(V_{BE})$
 $-V_{CE} = 0.5 \text{ V}; T_{amb} = \text{parameter}$
 (common emitter configuration)

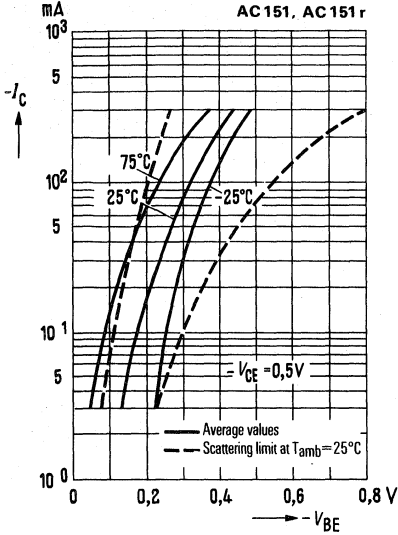

Output characteristics
 $I_C = f(V_{CE}); I_B = \text{parameter}$
 (common emitter configuration)

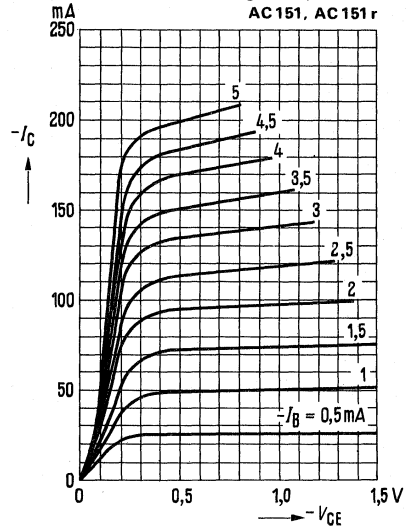

Input characteristics $I_B = f(V_{BE})$
 $-V_{CE} = 0.5 \text{ V}; T_{amb} = \text{parameter}$
 (common emitter configuration)

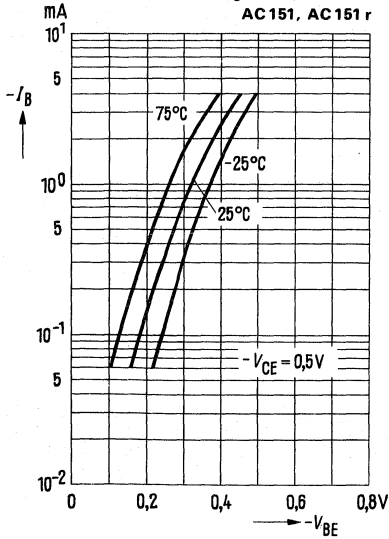

Output characteristics
 $I_C = f(V_{CE}); V_{BE} = \text{parameter}$
 (common emitter configuration)

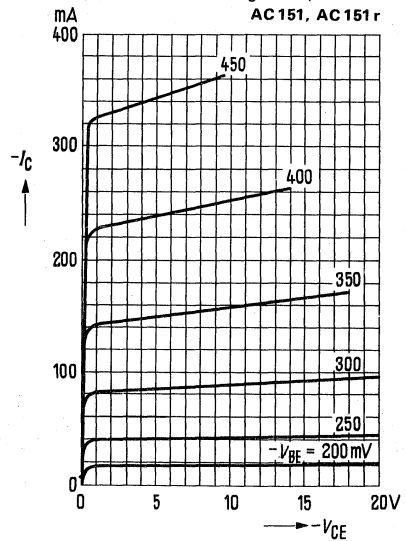

Collector-emitter saturation voltage

$V_{CEsat} = f(I_C); h_{FE} = 20$
(common emitter configuration)

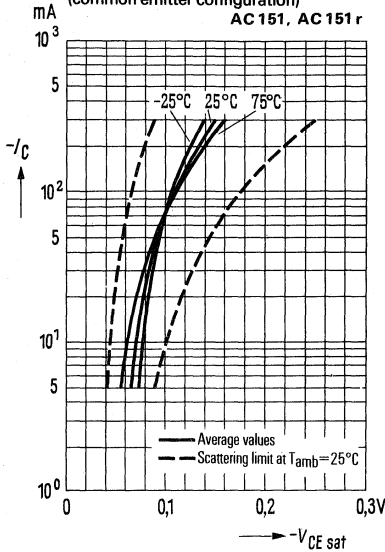

Collector cutoff current versus temperature

$I_{CBO} = f(T_{amb});$
For $V_{CE} = V_{CEmax}$

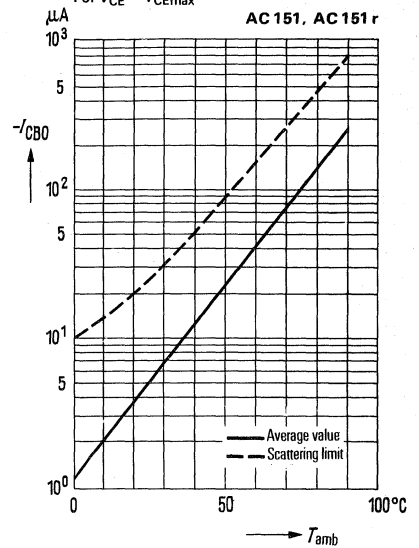

h-parameter versus collector current

$$H_e = \frac{h_e(I_C)}{h_e(I_C = -2 \text{ mA})} = f(I_C)$$

$-V_{CE} = 1 \text{ V}; f = 1 \text{ kHz}$
AC 151, AC 151 r

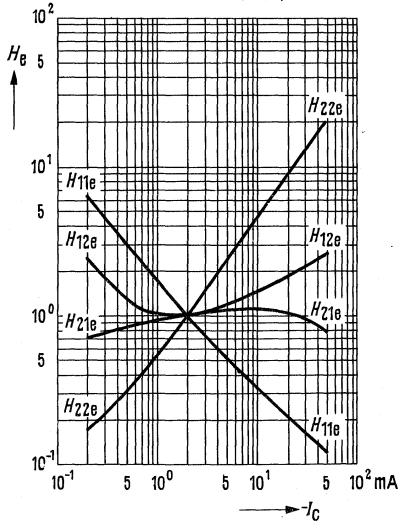

h-parameter versus collector-emitter voltage

$$H_e = \frac{h_e(V_{CE})}{h_e(V_{CE} = -1 \text{ V})} = f(V_{CE})$$

$-I_C = 2 \text{ mA}; f = 1 \text{ kHz}$
AC 151, AC 151 r

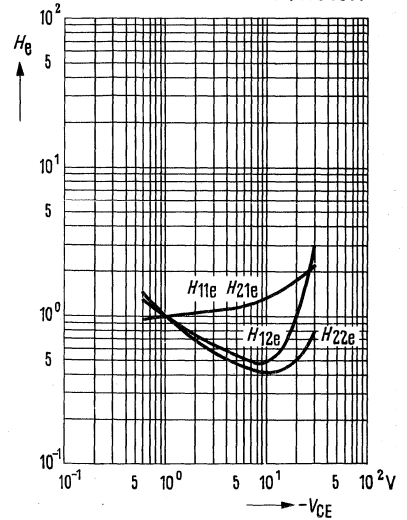

Noise figure versus collector current
 $NF = f(I_C)$
 $R_g = 500 \Omega$; $-V_{CE} = 5 \text{ V}$; $f = 1 \text{ kHz}$

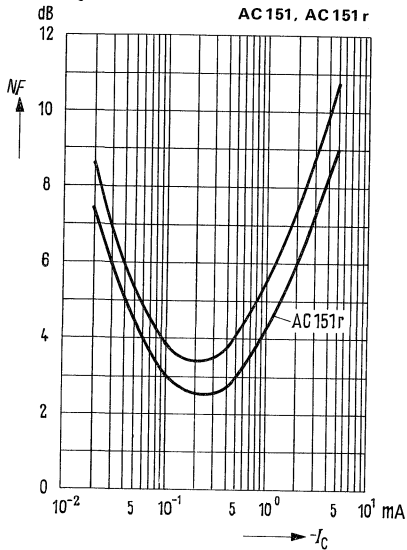

Collector-emitter voltage
 $V_{CER} = f(R_{BE})$

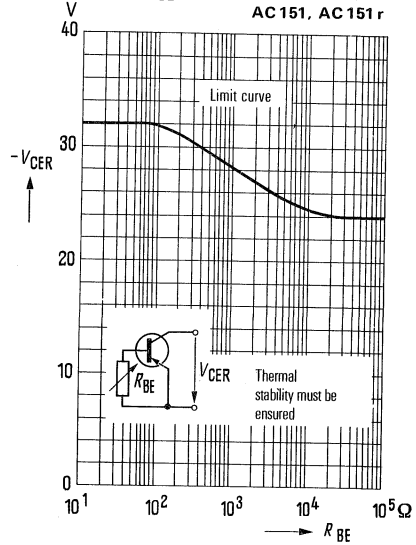

Noise figure versus collector-emitter voltage
 $NF = f(V_{CE})$
 $R_g = 500 \Omega$; $f = 1 \text{ kHz}$; $-I_C = 0.5 \text{ mA}$

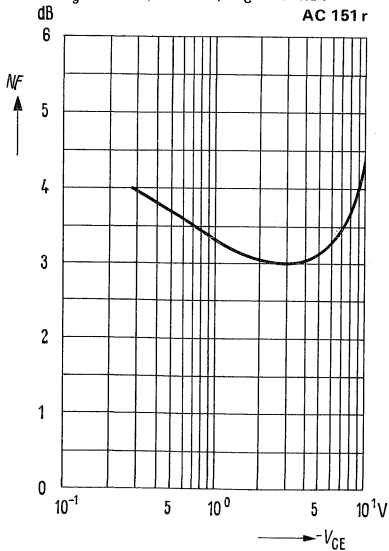

Noise figure versus internal resistance of generator
 $NF = f(R_g)$
 $f = 1 \text{ kHz}$; $-I_C = 0.5 \text{ mA}$; $-V_{CE} = 5 \text{ V}$

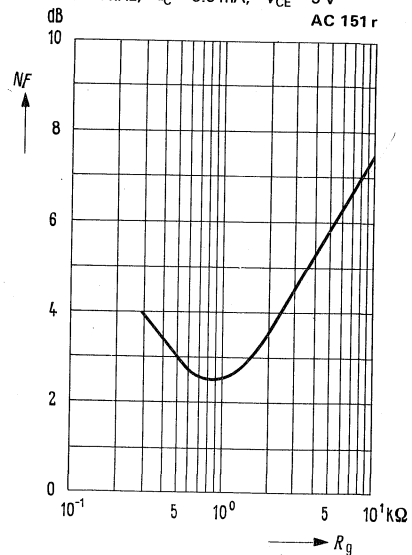

ACY 23 and ACY 32 are alloyed germanium PNP transistors in 1 A 3 DIN 41871 case (similar to TO-1). All leads are electrically insulated from the case. The collector terminal is marked by a red dot on the rim of the case. The transistors are particularly intended for use in AF input stages.

Not for new design

Type	Ordering code
ACY 23 V	Q60103-Y23-E
ACY 23 VI	Q60103-Y23-F
ACY 32 V	Q60103-Y32-E
ACY 32 VI	Q60103-Y32-F
Heat sink	Q62901-B1

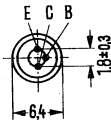
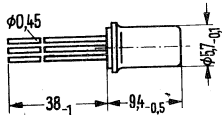
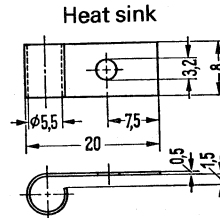

Approx. weight 1 g

Dimensions in mm

Thermal resistance between transistor case and heat sink below the fixing screw at careful mounting: $R_{th} \leq 10 \text{ K/W}$

Maximum ratings

Collector-emitter voltage
 Collector-emitter voltage ($V_{BE} \geq 0.2 \text{ V}$)
 Collector-base voltage
 Emitter-base voltage
 Collector current
 Base current
 Junction temperature
 Storage temperature range
 Total power dissipation ($T_{case} = 45 \text{ }^\circ\text{C}$)

	ACY 23, ACY 32	
$-V_{CEO}$	30	V
$-V_{CEV}$	32	V
$-V_{CBO}$	32	V
$-V_{EBO}$	16	V
$-I_C$	200	mA
$-I_B$	40	mA
T_j	90	$^\circ\text{C}$
T_{stg}	-55 to +75	$^\circ\text{C}$
P_{tot}	900	mW

Thermal resistance

Junction to ambient air
 Junction to case

R_{thJA}	≤ 300	K/W
R_{thJC}	≤ 50	K/W

Static characteristics ($T_{amb} = 25^{\circ}\text{C}$)

	ACY 23, ACY 32			$^{\circ}\text{C}$
	T_{amb}	25	60	
Collector cutoff current ($-V_{CBO} = 10\text{ V}$)	$-I_{CBO}$	3 (<10)	60 (<100)	μA
Collector cutoff current ($-V_{CBO} = 32\text{ V}$)	$-I_{CBO}$	5 (<18)	<150	μA
Collector cutoff current ($-V_{CEV} = 32\text{ V}$; $V_{BE} \geq 0.2\text{ V}$)	$-I_{CEV}$	5 (<18)*	<150	μA
Emitter cutoff current ($-V_{EBO} = 16\text{ V}$)	$-I_{EBO}$	4 (<18)*	<120	μA

Static characteristics ($T_{amb} = 25^{\circ}\text{C}$) ACY 23, ACY 32

$-V_{CE}$	$-I_C$ mA	$-I_B$ μA	h_{FE} I_C/I_B	V_{BE} V
0.5	2	30	67	0.13 (<0.2)
0.5	10	137	73	0.18 (<0.3)
0.5	100	1560	64	0.32 (<0.55)

Collector-emitter saturation voltage ($I_C = 100\text{ mA}$; $I_B = 5\text{ mA}$)	$-V_{CEsat}$	0.11 (<0.18)	V
Collector-emitter saturation voltage ($-I_C = 200\text{ mA}$ for the characteristic which, at constant base current, intersects the operating point, where $-I_C = 220\text{ mA}$ and $-V_{CE} = 0.5\text{ V}$)	$-V_{CEsat}$	0.25 (<0.4)	V

Dynamic characteristics ($T_{amb} = 25^{\circ}\text{C}$)

The transistors ACY 23 and ACY 32 are grouped according to the small-signal current gain h_{fe} and marked by Roman numerals.

Operating point: $-I_C = 1\text{ mA}$; $-V_{CE} = 5\text{ V}$; $f = 1\text{ kHz}$

h_{fe} group	V	VI		
h_{fe}	50 to 100 ACY 23	75 to 150* ACY 32	—	
Operating point: $-I_C = 1\text{ mA}$; $-V_{CE} = 5\text{ V}$				
Transition frequency f_T	1.5 (>0.5)	1.5 (>0.5)	MHz	
Base intrinsic resistance $r_{bb'}$	75 (<200)	75 (<200)	Ω	
Collector-junction capacitance $C_{b'c}$	27	27	pF	
Noise figure ($-I_C = 0.5\text{ mA}$; $-V_{CE} = 5\text{ V}$; $f = 1\text{ kHz}$; $\Delta f = 200\text{ Hz}$; $R_g = 500\ \Omega$)	NF	4 (<10)*	3 (<6)*	dB
Operating point: $-I_C = 1\text{ mA}$; $-V_{CE} = 5\text{ V}$; $f = 1\text{ kHz}$	h_{11e}	3 (1.2 to 5)	3 (1.2 to 5)	k Ω
	h_{12e}	7 (<15)	7 (<15)	10^{-4}
	h_{21e}	100 (50 to 150)	100 (50 to 150)	—
	h_{22e}	40 (<75)	40 (<75)	μS

* AQL = 0.65%

Total perm. power dissipation versus temperature

$P_{tot} = f(T); R_{th} = \text{parameter}$

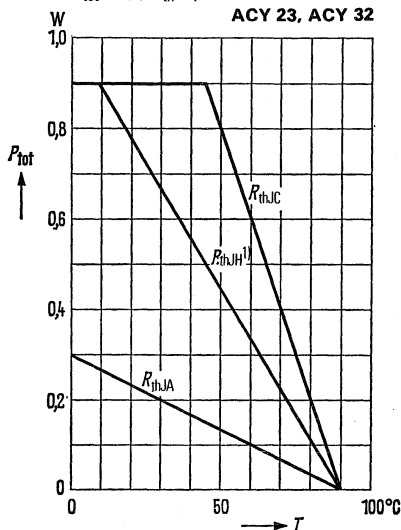

1) Heat sink aluminum 12.5 cm² x 2 mm

Permissible pulse load

$r_{thJC} = f(t); v = \text{parameter}$

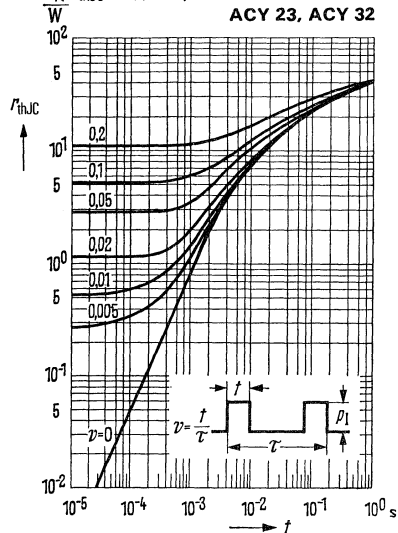

Input characteristics $I_B = f(V_{BE})$

$-V_{BE} = 0.5 \text{ V}; T_{amb} = \text{parameter}$
(common emitter configuration)

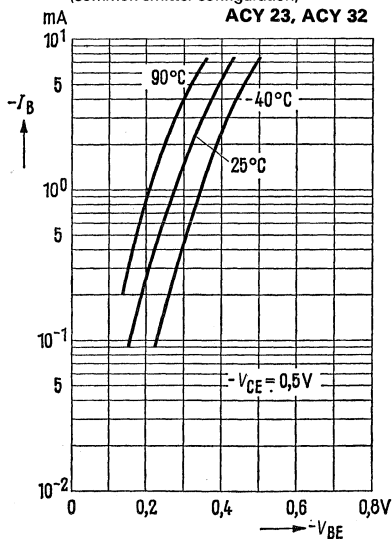

Collector current $I_C = f(V_{BE})$

$-V_{CE} = 0.5 \text{ V}, T_{amb} = \text{parameter}$
(common emitter configuration)

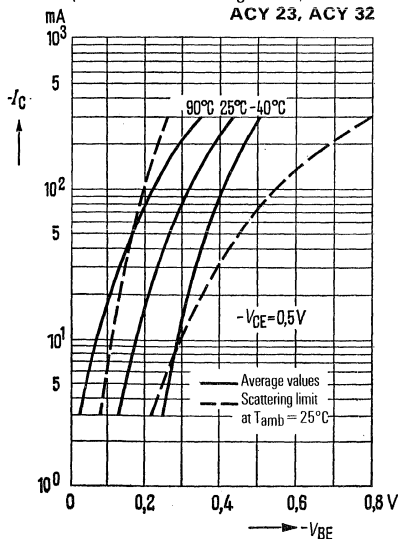

DC current gain $h_{FE} = f(I_C)$
 $-V_{CE} = 0.5 \text{ V}; T_{amb} = \text{parameter}$
 (common emitter configuration)

ACY 23 V, ACY 32 V

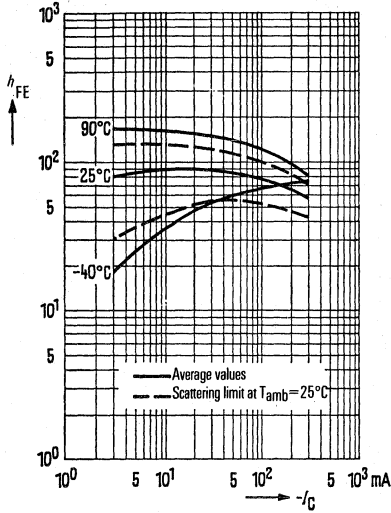

DC current gain $h_{FE} = f(I_C)$
 $-V_{CE} = 0.5 \text{ V}; T_{amb} = \text{parameter}$
 (common emitter configuration)

ACY 23 VI, ACY 32 VI

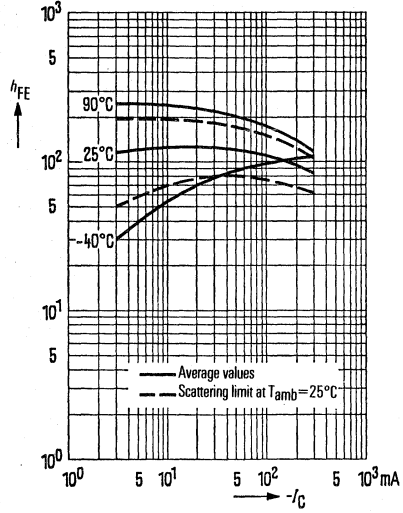

Output characteristics
 $I_C = f(V_{CE}); I_B = \text{parameter}$
 (common emitter configuration)

ACY 23, ACY 32

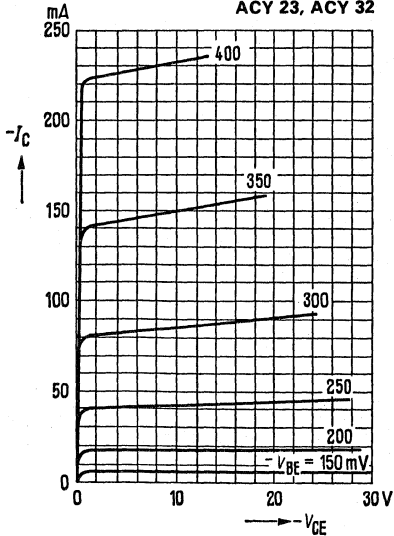

Output characteristics
 $I_C = f(V_{CE}); I_B = \text{parameter}$
 (common emitter configuration)

ACY 23, ACY 32

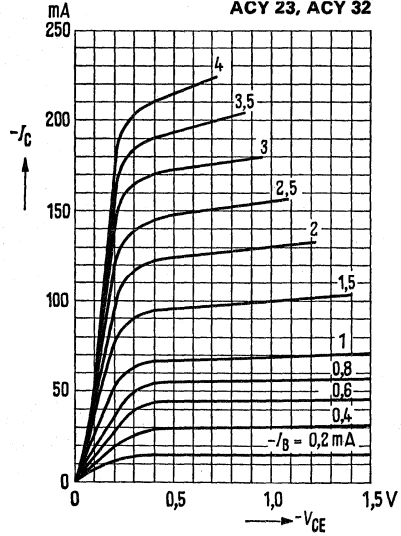

Collector-emitter saturation voltage
 $V_{CEsat} = f(I_C)$; $h_{FE} = 20$; $T_{amb} = \text{parameter}$
 (common emitter configuration)

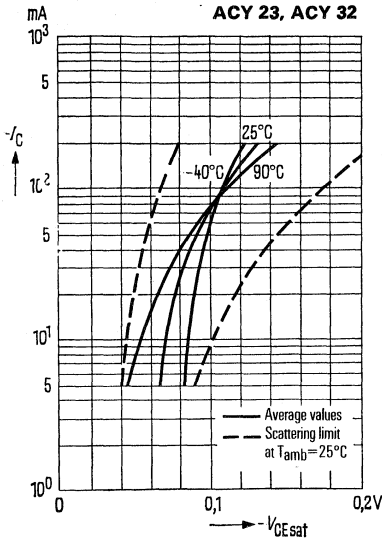

Collector cutoff current versus temperature
 $I_{CBO} = f(T_{amb})$
 $-V_{CBO} = 32\text{ V}$; $-V_{CBO} = 10\text{ V}$

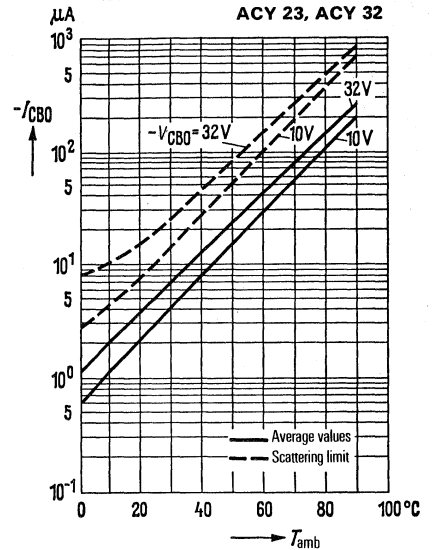

h-parameter versus collector current

$$H_e = \frac{h_o(I_C)}{h_e(I_C = -2\text{ mA})} = f(I_C)$$

$-V_{CE} = 1\text{ V}$; $f = 1\text{ kHz}$

ACY 23, ACY 32

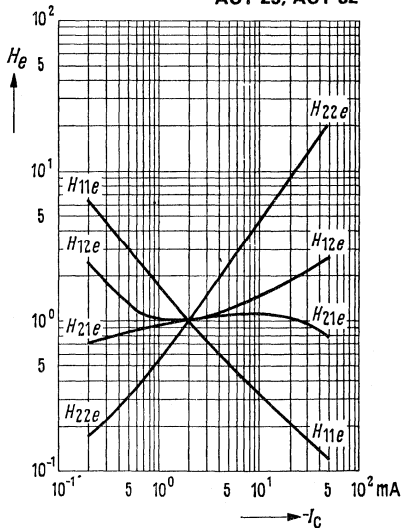

h-parameter versus collector-emitter voltage

$$H_e = \frac{h_o(V_{CE})}{h_e(V_{CE} = -1\text{ V})} = f(V_{CE})$$

$-I_C = 2\text{ mA}$; $f = 1\text{ kHz}$

ACY 23, ACY 32

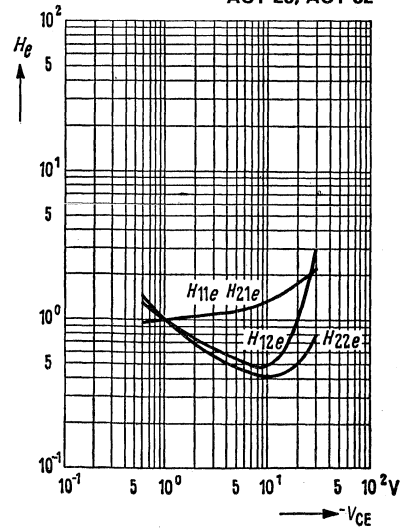

Noise figure versus collector-emitter voltage $NF = f(V_{CE})$
 $R_g = 500 \Omega; f = 1 \text{ kHz}; -I_C = 0.5 \text{ mA}$

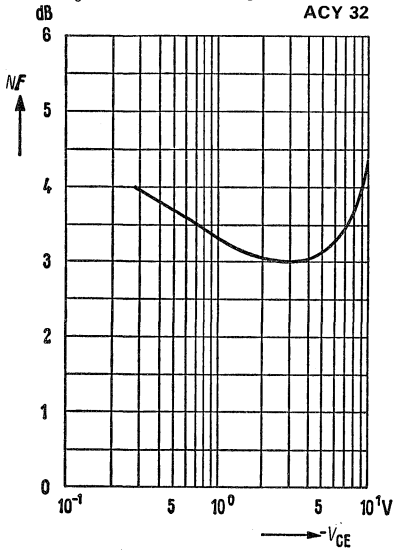

Noise figure versus internal resistance of generator $NF = f(R_g)$
 $f = 1 \text{ kHz}; -I_C = 0.5 \text{ mA}; -V_{CE} = 5 \text{ V}$

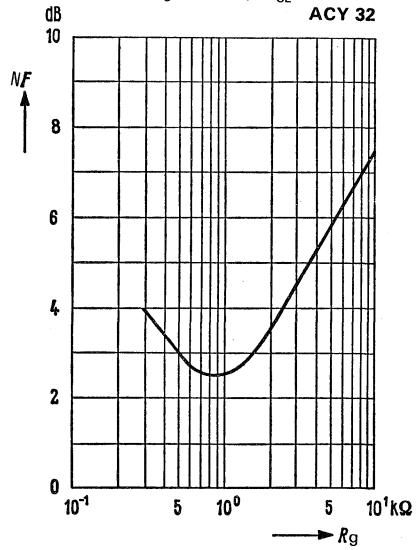

Noise figure versus collector current $NF = f(I_C)$
 $R_g = 500 \Omega; -V_{CE} = 5 \text{ V}; f = 1 \text{ kHz}$

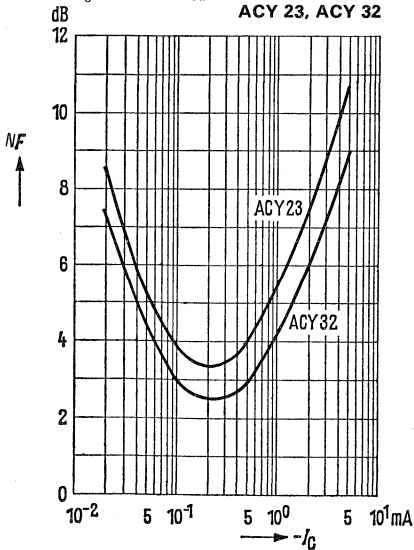

for input, mixer, and oscillator stages up to 260 MHz

The AF 106 is a general-purpose germanium PNP high frequency mesa transistor in TO 72 case (18 A 4 DIN 41 876). The leads are electrically insulated from the case.

Type	Ordering code
AF 106	Q60106-X106

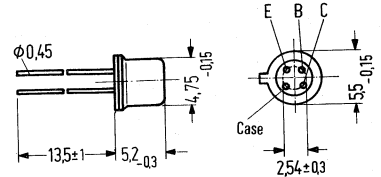

Approx. weight 0.4 g

Dimensions in mm

Maximum ratings

Collector-emitter voltage	$-V_{CEO}$	18	V
Collector-base voltage	$-V_{CBO}$	25	V
Emitter-base voltage	$-V_{EBO}$	0.3	V
Collector current	$-I_C$	10	mA
Junction temperature	T_j	90	°C
Storage temperature range	T_{stg}	-30 to +75	°C
Total power dissipation ($T_{amb} = 45\text{ °C}$)	P_{tot}	60	mW

Thermal resistance

Junction to ambient air	R_{thJA}	≤ 750	K/W
Junction to case	R_{thJC}	≤ 400	K/W

Static characteristics ($T_{amb} = 25\text{ °C}$)

$-V_{CE}$ V	I_C mA	$-I_B$ μA	h_{FE} I_C/I_B	$-V_{BE}$ V
12	1	20 (<40)	50 (>25)	0.325 (0.25 to 0.38)
6	2	29	70	0.34 (0.28 to 0.4)

Collector cutoff current ($-V_{CBO} = 12\text{ V}$)

Collector-base breakdown voltage

($-I_{CBO} = 100\text{ }\mu A$)

Collector-emitter breakdown voltage

($-I_{CEO} = 500\text{ }\mu A$)

Emitter-base breakdown voltage

($-I_{EBO} = 100\text{ }\mu A$)

$-I_{CBO}$	0.5 (<10)	μA
$-V_{(BR)CBO}$	>25	V
$-V_{(BR)CEO}$	>18	V
$-V_{(BR)EBO}$	>0.3	V

Dynamic characteristics ($T_{amb} = 25^{\circ}\text{C}$)

Operating point: $-I_C = 1\text{ mA}$; $-V_{CB}$ or $-V_{CE} = 12\text{ V}$

Transition frequency ($f = 100\text{ MHz}$)

Max. frequency of oscillation $\left(f_{max} = \sqrt{\frac{f_T}{8 \cdot \pi \cdot f_{bb'} \cdot C_{b'c}}} \right) f_{max}$

Small signal current gain ($f = 1\text{ kHz}$)

Noise figure ($f = 200\text{ MHz}$; $R_g = 60\ \Omega$)

Reverse transfer capacitance ($f = 450\text{ kHz}$)

Feedback time constant ($f = 2.5\text{ MHz}$)

Operating point: $-I_C = 3\text{ mA}$; $-V_{CB} = 10\text{ V}$

$f = 200\text{ MHz}$; $R_L = 920\ \Omega$

Power gain (measured in circuit shown below)

f_T	220	MHz
f_{max}	1.2	GHz
h_{fe}	65 (> 30)	-
NF	5.5 (< 7.5)	dB
$-C_{12e}$	0.45	pF
$f_{bb'} \cdot C_{b'c}$	6	psec
G_{pb}	17.5 (> 14)	dB

Four-pole characteristics:

$-I_C = 1\text{ mA}$; $-V_{CB} = 12\text{ V}$; $f = 200\text{ MHz}$

$g_{11b} = 31\text{ mS}$

$g_{12b} = 0\text{ mS}$

$|y_{21b}| = 27\text{ mS}$

$g_{22} = 0,15\text{ mS}$

$b_{11b} = -12\text{ mS}$

$b_{12b} = -0,5\text{ mS}$

$\varphi_{21b} = 115^{\circ}$

$b_{22} = 1,9\text{ mS}$

$c_{11b} = -9,5\text{ pF}$

$c_{12b} = -0,4\text{ pF}$

$c_{22} = 1,5\text{ pF}$

$-I_C = 1\text{ mA}$; $-V_{CE} = 6\text{ V}$; $f = 100\text{ MHz}$

$g_{11b} = 36\text{ mS}$

$g_{12b} = 0,04\text{ mS}$

$g_{21b} = -27\text{ mS}$

$g_{22} = 0,09\text{ mS}$

$b_{11b} = -6\text{ mS}$

$b_{12b} = -0,48\text{ mS}$

$b_{21b} = 20\text{ mS}$

$b_{22} = 1\text{ mS}$

Test circuit for power gain at $f = 200\text{ MHz}$

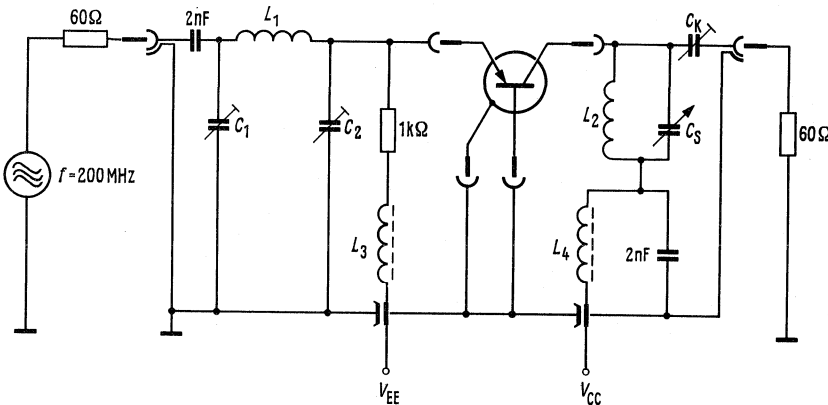

$L_1 = 3\text{ turns}$; $d = 1\text{ mm}$; $D = 6.5\text{ mm}$
 $L_2 = 2\text{ turns}$; $d = 1\text{ mm}$; $D = 6.5\text{ mm}$
 $L_3 = L_4 = 20\text{ turns}$ 0.5 CuLs
 on core B63310-K1-A12.3

$C_K = 1.5\text{ to }5\text{ pF}$ so that $R_L = 920\ \Omega$
 $C_1 = 6.5\text{ to }18\text{ pF}$
 $C_2 = 9.5\text{ to }20\text{ pF}$
 $C_3 = 3\text{ to }10\text{ pF}$

Total perm. power dissipation versus temperature
 $P_{tot} = f(T); R_{th} = \text{parameter}$

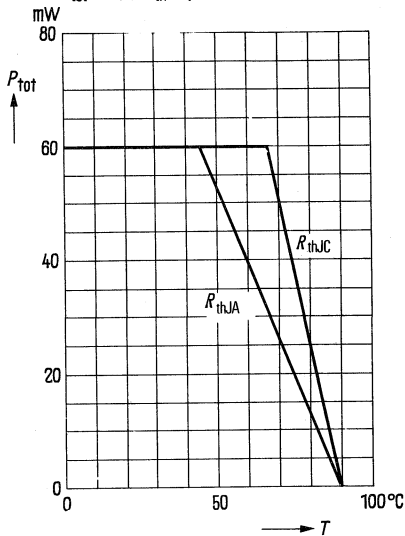

Collector cutoff current versus temperature
 $I_{CBO} = f(T_{amb})$
 $-V_{CBO} = 12\text{ V}$

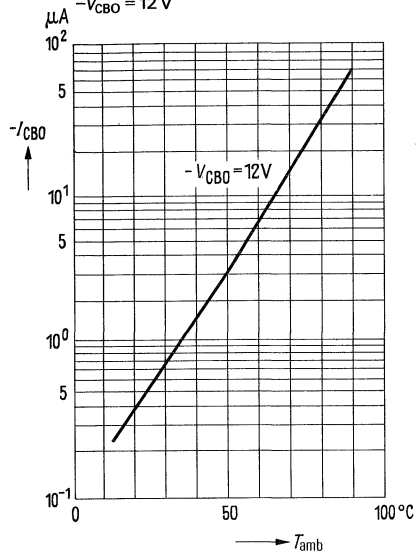

Collector current $I_C = f(V_{BE})$
 $-V_{CE} = 5\text{ V}$
 (common emitter configuration)

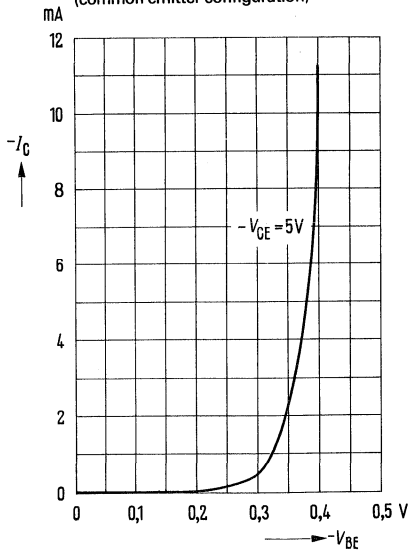

Collector current $I_C = f(I_B)$
 $-V_{CE} = 5\text{ V}$
 (common emitter configuration)

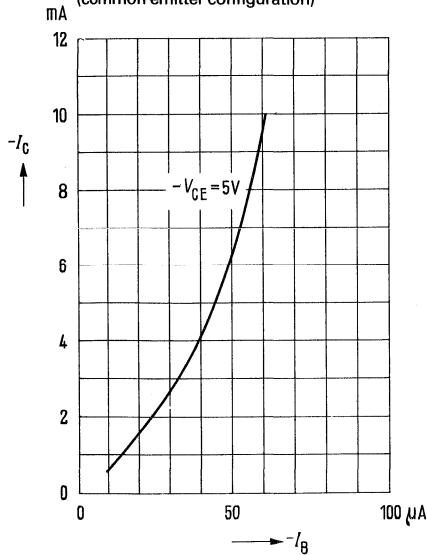

Output characteristics $I_C = f(V_{CE})$;
 I_B = parameter
 (common emitter configuration)

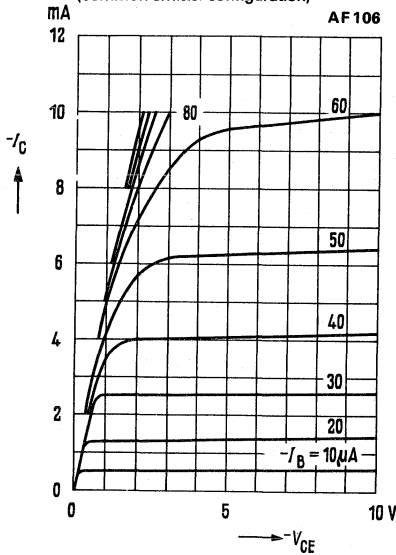

Output characteristics $I_C = f(V_{CE})$;
 V_{BE} = parameter
 (common emitter configuration)

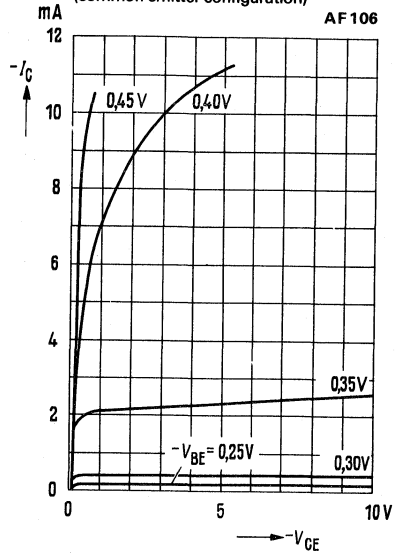

Optimum power gain $G_{p,opt} = f(f)$
 $-V_{CE} = 6V$; $-I_C = 2mA$
 (common emitter configuration)

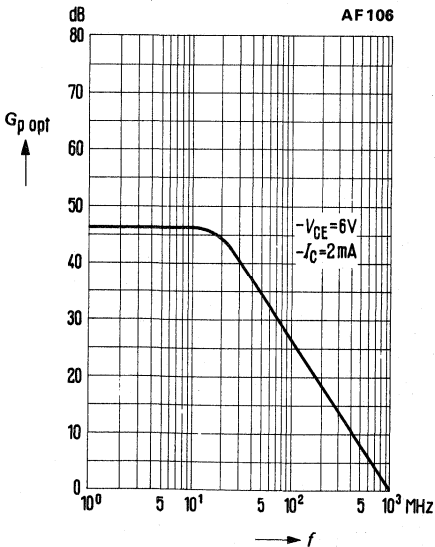

Noise figure versus frequency
 $NF = f(f)$; $-V_{CB} = 12V$; $-I_C = 1mA$;
 $R_g = 60 \Omega$
 (common base configuration)

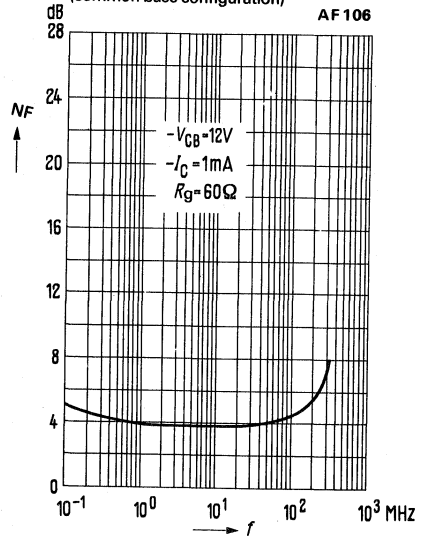

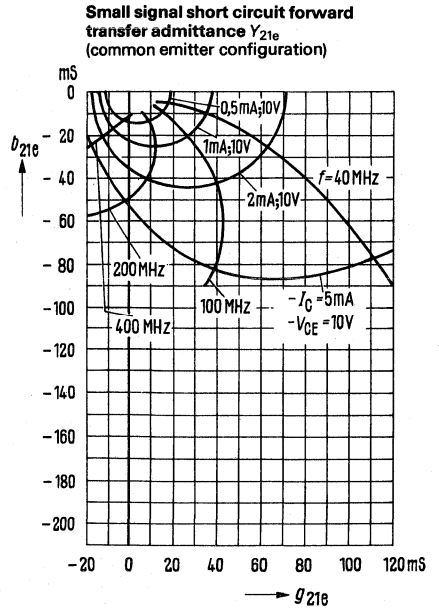
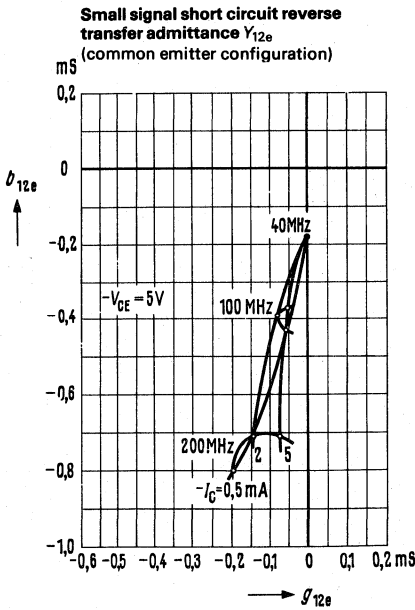
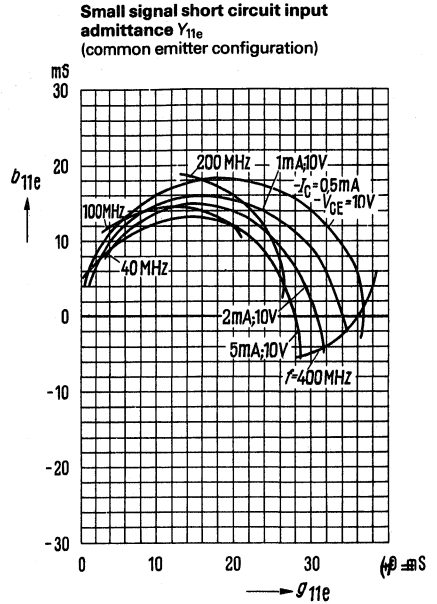
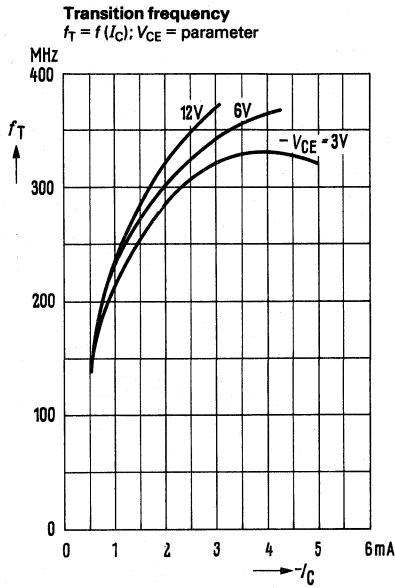

Small signal short circuit input admittance Y_{11b}
(common base configuration)

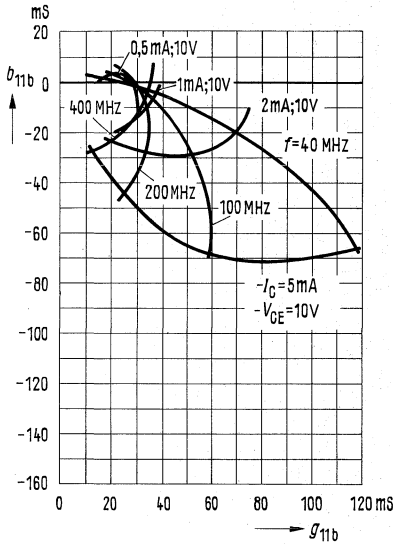

Small signal short circuit reverse transfer admittance Y_{12b}
(common base configuration)

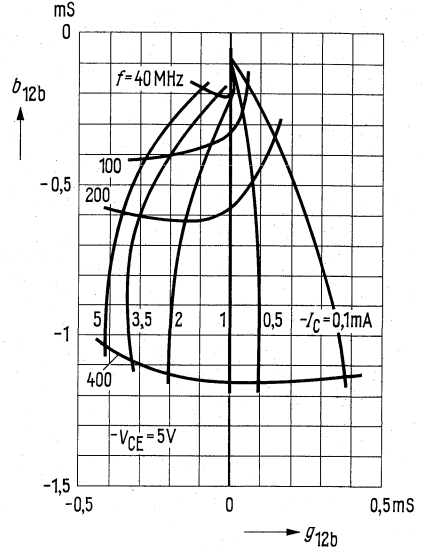

Small signal short circuit forward transfer admittance Y_{21b}
(common base configuration)

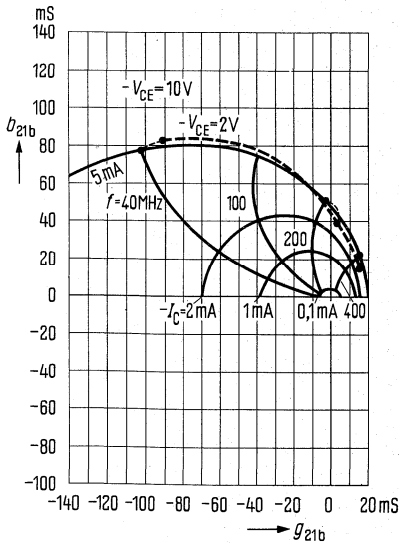

Small signal short circuit output admittance Y_{22b}
(common emitter and base configuration)

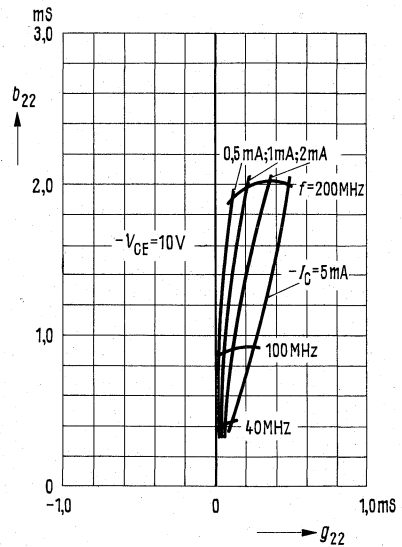

for AGC input stages up to 260 MHz

AF 109 R is a germanium PNP RF mesa transistor in TO 72 case (18 A 4 DIN 41876). The terminals are electrically insulated from the case.

Type	Ordering code
AF 109 R	Q60106-X109-R1

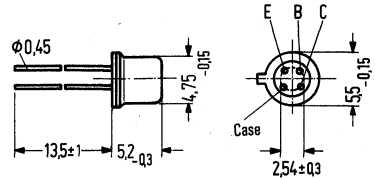

Approx. weight 0.35 g Dimensions in mm

Maximum ratings

Collector-emitter voltage	$-V_{CEO}$	15	V
Collector-base voltage	$-V_{CBO}$	20	V
Emitter-base voltage	$-V_{EBO}$	0.3	V
Collector current	$-I_C$	10	mA
Emitter current	I_E	11	mA
Base current	$-I_B$	1	mA
Junction temperature	T_j	90	°C
Storage temperature range	T_{stg}	-30 to +75	°C
Total power dissipation ($T_{amb} = 45^\circ\text{C}$)	P_{tot}	60	mW

Thermal resistance

Junction to ambient air	R_{thJA}	≤ 750	K/W
Junction to case	R_{thJC}	≤ 400	K/W

Static characteristics ($T_{amb} = 25^\circ\text{C}$)

$-V_{CE}$ V	$-I_C$ mA	$-I_B$ μA	h_{FE} I_C/I_B	$-V_{BE}$ mV
12	1.5	30	50 (>20)	380 (320 to 430)
6	2	36	55	380 (320 to 430)
6	5	66	75	405 (360 to 450)

Static characteristics ($T_{amb} = 25^{\circ}\text{C}$)

Collector cutoff current ($-V_{CBO} = 20\text{ V}$)	$-I_{CBO}$	0.5 (<8)	μA
Emitter cutoff current ($-V_{EBO} = 0.3\text{ V}$)	$-I_{EBO}$	0.5 (<100)	μA
Collector cutoff current ($-V_{CEO} = 15\text{ V}$)	$-I_{CEO}$	<500	μA

Dynamic characteristics ($T_{amb} = 25^{\circ}\text{C}$)

Reverse transfer capacitance ($-I_C = 1\text{ mA}$; $-V_{CE} = 12\text{ V}$; $f = 450\text{ kHz}$)	$-C_{12e}$	0.25	pF
---	------------	------	----

Operating point:

$-V_{CC} = 12\text{ V}$; $R_{EE} = 1\text{ k}\Omega$; $f = 200\text{ MHz}$
 Power gain ($-I_C = 2\text{ mA}$; $R_L = 920\ \Omega$)
 Noise figure ($-I_C = 2\text{ mA}$; $R_g = 60\ \Omega$)
 Adjustable amplification range ($I_E \leq 9\text{ mA}$)
 Interference voltage at operating point of
 minimum cross modulation stability

G_{pb}	16.5 (> 13)	dB
NF	4 (< 4.8)	dB
G_{pb}	36	dB
$V_{int} 1\%$	22	mW

$V_{int} = 1\%$ is the rms value of half the EMF (terminal voltage under matching condition) of a 100% sine-wave modulated TV carrier with a generator impedance of $240\ \Omega$, which causes 1% amplitude modulation on the signal carrier.

$g_{11b} = 24\text{ mS}$	$g_{12b} = -0.2\text{ mS}$	$g_{21b} = -12\text{ mS}$	$g_{22b} = 0.2\text{ mS}$
$b_{11b} = -32\text{ mS}$	$b_{12b} = -0.16\text{ mS}$	$b_{21b} = 35\text{ mS}$	$b_{22b} = 1.6\text{ mS}$

Test circuit for power gain at $f = 200\text{ MHz}$

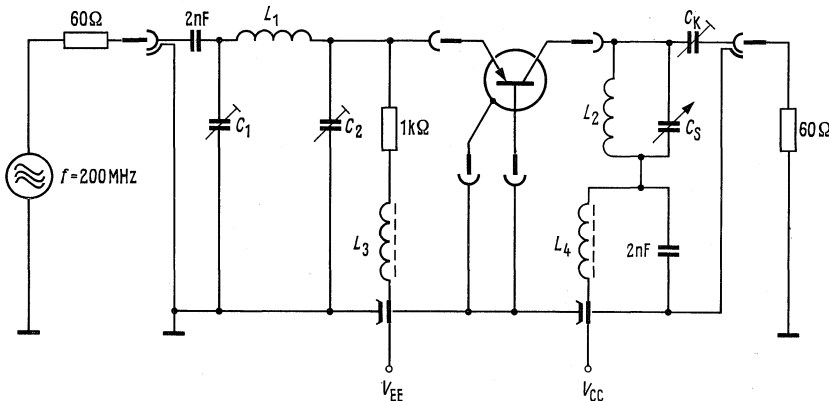

- $L_1 = 3\text{ turns}$; $d = 1\text{ mm}$; $\text{dia} = 6.5\text{ mm}$
- $L_2 = 2\text{ turns}$; $d = 1\text{ mm}$; $\text{dia} = 6.5\text{ mm}$
- $L_3 = L_4 = 20\text{ turns}$; 0.5 CuLs
on core B63310-K-1A12,3
- $C_K = 1.5\text{ to }5\text{ pF}$, so that $R_L = 920\ \Omega$
- $C_1 = 6.5\text{ to }18\text{ pF}$
- $C_2 = 9.5\text{ to }20\text{ pF}$
- $C_s = 3\text{ to }10\text{ pF}$

Total perm. power dissipation versus temperature
 $P_{tot} = f(T)$; R_{th} = parameter

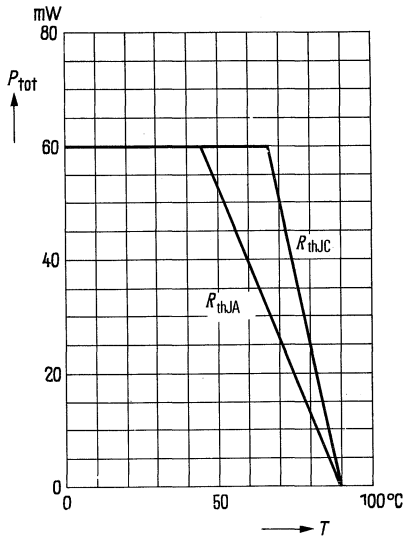

Input characteristic $I_B = f(V_{BE})$
 $-V_{CE} = 5 V$
 (common emitter configuration)

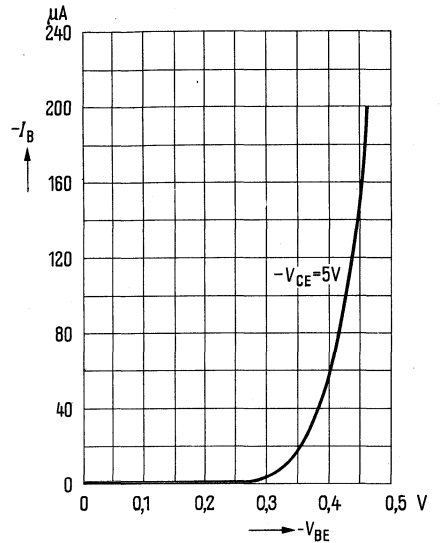

Collector current $I_C = f(I_B)$
 $-V_{CE} = 5 V$
 (common emitter configuration)

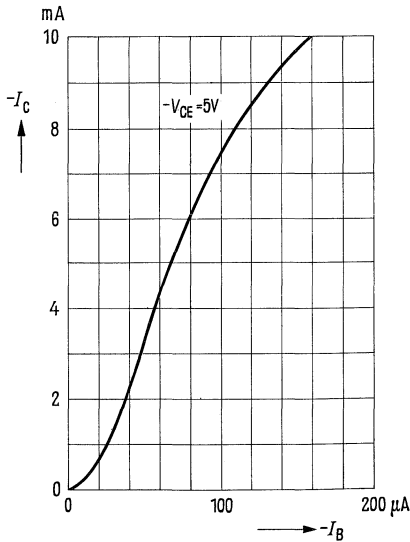

Collector current $I_C = f(V_{BE})$
 $-V_{CE} = 5 V$
 (common emitter configuration)

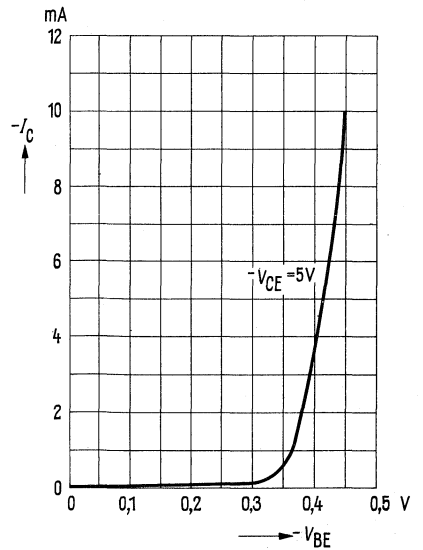

**Output characteristics $I_C = f(V_{CE})$;
(common emitter configuration)**

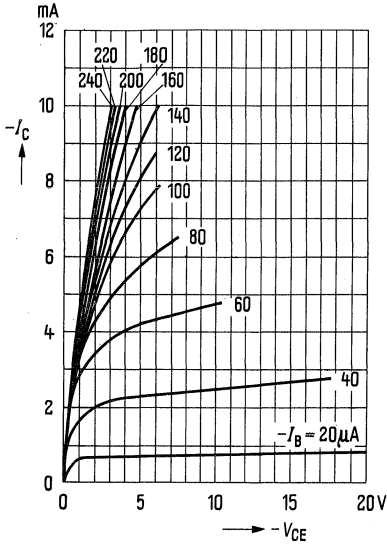

**Output characteristics $I_C = f(V_{CB})$;
 $I_E = \text{parameter}$
(common base configuration)**

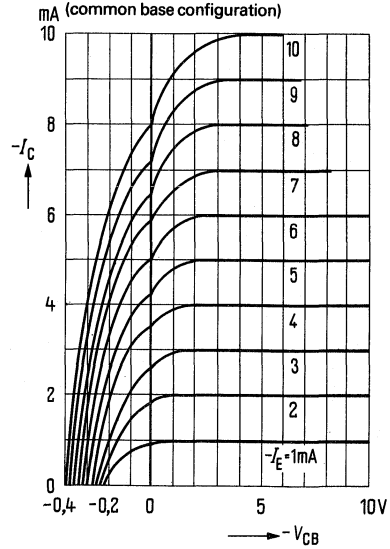

**Collector cutoff current
versus temperature
 $I_{CBO} = f(T_{amb}); -V_{CBO} = 20 \text{ V}$**

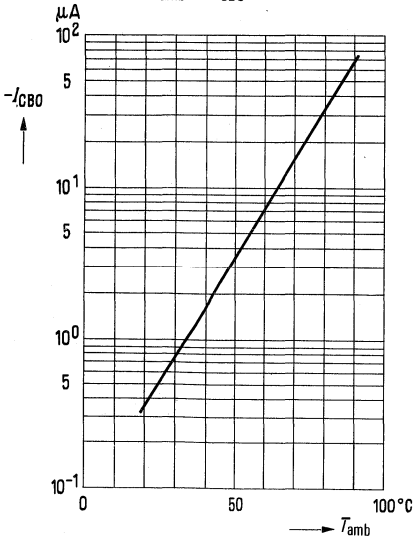

**Interference voltage $V_{int} 1\% = f(I_C)$
Power gain $G_{pb} = f(I_C)$
 $f = 200 \text{ MHz}; -V_{batt} = 12 \text{ V}$
 $R_V = 1 \text{ k}\Omega; R_L = 0.9 \text{ k}\Omega$
(common base configuration)**

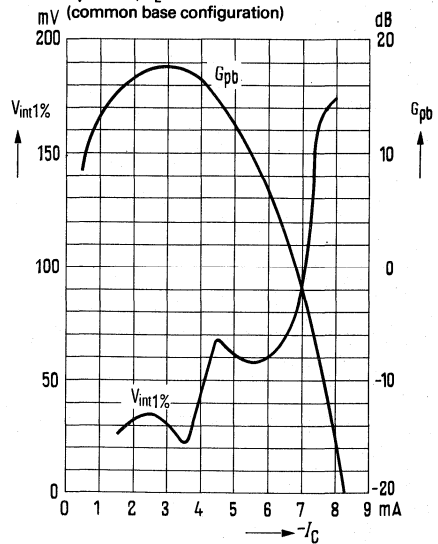

Small signal short circuit input transfer admittance y_{11b}
(common base configuration)
 $-V_{CC} = 12\text{ V}; R_{EE} = 1\text{ k}\Omega; f = 200\text{ MHz}$

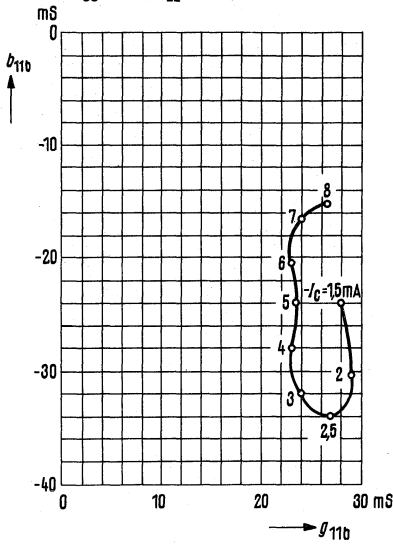

Small signal short circuit forward transfer admittance y_{21b}
(common base configuration)
 $-V_{CC} = 12\text{ V}; R_{EE} = 1\text{ k}\Omega; f = 200\text{ MHz}$

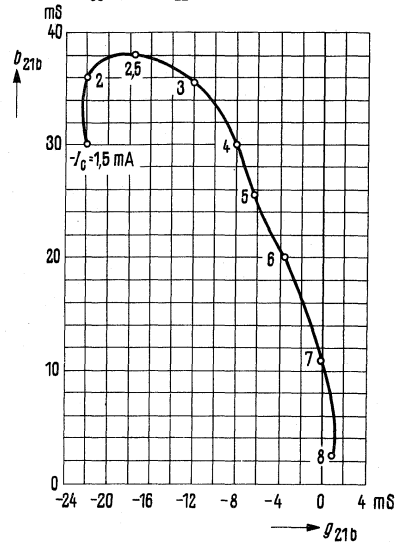

Small signal short circuit reverse transfer admittance y_{12b}
(common base configuration)
 $-V_{CC} = 12\text{ V}; R_{EE} = 1\text{ k}\Omega; f = 200\text{ MHz}$

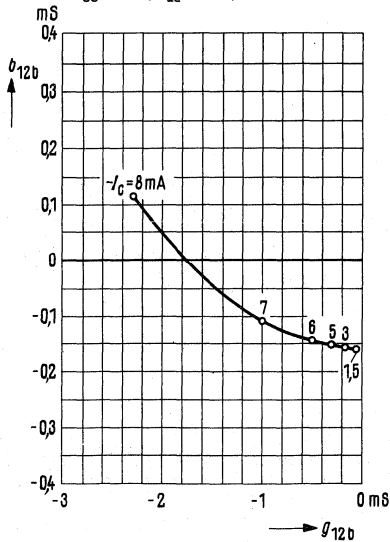

Small signal short circuit output admittance y_{22b}
(common base configuration)
 $-V_{CC} = 12\text{ V}; R_{EE} = 1\text{ k}\Omega; f = 200\text{ MHz}$

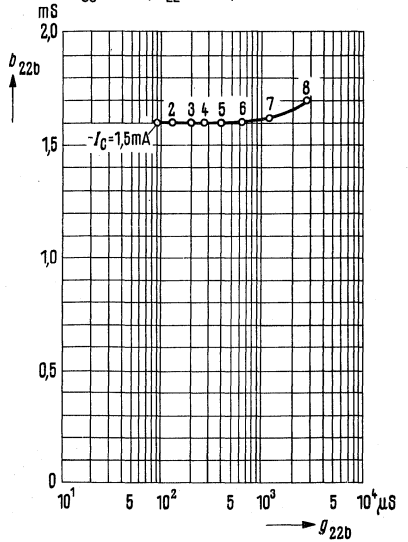

for input stages, mixer and oscillator stages up to 860 MHz

AF 139 is a germanium PNP mesa transistor in TO 92 case (18 A 4 DIN 41876). The leads are electrically insulated from the case.

Type	Ordering code
AF 139	Q60106-X139

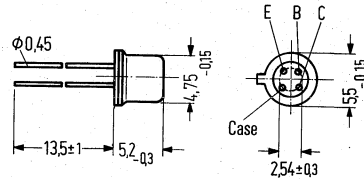

Approx. weight 0.4 g

Dimensions in mm

Maximum ratings

Collector-emitter voltage	$-V_{CEO}$	15	V
Collector-base voltage	$-V_{CBO}$	20	V
Emitter-base voltage	$-V_{EBO}$	0.3	V
Collector current	$-I_C$	10	mA
Emitter current	I_E	11	mA
Base current	$-I_B$	1	mA
Junction temperature	T_j	90	°C
Storage temperature range	T_{stg}	-30 to +75	°C
Total power dissipation ($T_{amb} = 45^\circ\text{C}$)	P_{tot}	60	mW

Thermal resistance

Junction to ambient air	R_{thJA}	≤ 750	K/W
Junction to case	R_{thJC}	≤ 400	K/W

Static characteristics ($T_{amb} = 25^{\circ}\text{C}$)

$-V_{CE}$ V	$-I_C$ mA	$-I_B$ μA	h_{FE} I_C/I_B	$-V_{BE}$ mV
12	1.5	30	50 (>10)	380 (320 to 430)
6	2	36	55	380 (320 to 430)
6	5	66	75	405 (360 to 450)

Collector cutoff current ($-V_{CBO} = 20\text{ V}$)	$-I_{CBO}$	0.5 (<8)	μA
Emitter cutoff current ($-V_{EBO} = 0.3\text{ V}$)	$-I_{EBO}$	2 (<100)	μA
Collector cutoff current ($-V_{CEO} = 15\text{ V}$)	$-I_{CEO}$	<500	μA

Dynamic characteristics ($T_{amb} = 25^{\circ}\text{C}$)

Operating point: $-I_C = 1.5\text{ mA}$; $-V_{CE} = 12\text{ V}$

Transition frequency ($f = 100\text{ MHz}$)

Feedback time constant ($f = 2.5\text{ MHz}$)

	f_T	550	MHz
	$r_{bb} \cdot C_{b'c}$	3	ps
Max. frequency of oscillation $f_{max} = \sqrt{\frac{f_T}{8 \pi \cdot r_{bb'} \cdot c_{b'c}}}$	f_{max}	2.7	GHz
Reverse transfer capacitance ($f = 450\text{ kHz}$)	$-C_{12e}$	0.25	pF
Power gain ($f = 800\text{ MHz}$; $R_L = 1.4\text{ k}\Omega$)	$G_{pb}^{1)}$	11 (>9)	dB
Power gain ($f = 900\text{ MHz}$)	G_{pb}	9 (>6.5)	dB
Feedback damping ($f = 800\text{ MHz}$)	$-G_{pb\text{binv}}^{1)}$	23	dB
Noise figure ($f = 800\text{ MHz}$; $R_g = 60\ \Omega$)	$NF^{1)}$	7 (<8.2)	dB
Noise figure ($f = 900\text{ MHz}$; $R_L = 0.5\text{ k}\Omega$; $-V_{CE} = 10\text{ V}$; $I_E = 2\text{ mA}$)	NF	7.5 (≤ 9)	dB

Four-pole characteristics:

$-I_C = 1.5\text{ mA}$; $-V_{CF} = 12\text{ V}$; $f = 200\text{ MHz}$

$g_{11b} = 28\text{ mS}$	$-g_{12b} = 0,06\text{ mS}$	$-g_{21b} = 22\text{ mS}$	$g_{22b} = 0,09\text{ mS}$
$-b_{11b} = 24\text{ mS}$	$-b_{12b} = 0,16\text{ mS}$	$b_{21b} = 30\text{ mS}$	$b_{22b} = 1,9\text{ mS}$

$-I_C = 1,5\text{ mA}$; $-V_{CE} = 12\text{ V}$; $f = 800\text{ MHz}$

$g_{11b} = 7\text{ mS}$	$y_{12b} = 0,4\text{ mS}$	$ y_{21b} = 14\text{ mS}$	$g_{22b} = 0,5\text{ mS}$
$-b_{11b} = 11\text{ mS}$	$\varphi_{12b} = -120^{\circ}$	$\varphi_{21b} = 35^{\circ}$	$b_{22b} = 7,5\text{ mS}$

1) measured in circuit shown on page 106

Test circuit for power gain and noise figure at $f = 200$ MHz

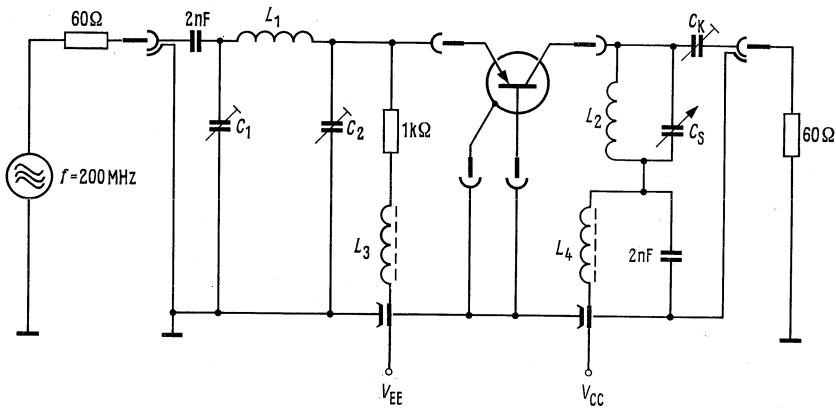

$L_1 = 3$ turns; $d = 1$ mm; dia = 6.5 mm
 $L_2 = 2$ turns; $d = 1$ mm; dia = 6.5 mm
 $L_3 = L_4 = 20$ turns 0.5 CuLs
 on core B63310-K1-A12.3

$C_K = 1.5$ to 5 pF so that $R_L = 920 \Omega$
 $C_1 = 6.5$ to 18 pF
 $C_2 = 9.5$ to 20 pF
 $C_s = 3$ to 10 pF

Test circuit for power gain and noise figure at $f = 800$ MHz

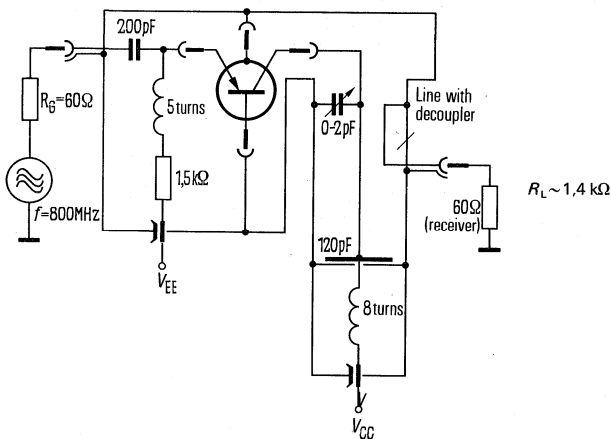

Total perm. power dissipation versus temperature

$P_{tot} = f(T); R_{th}$ = parameter

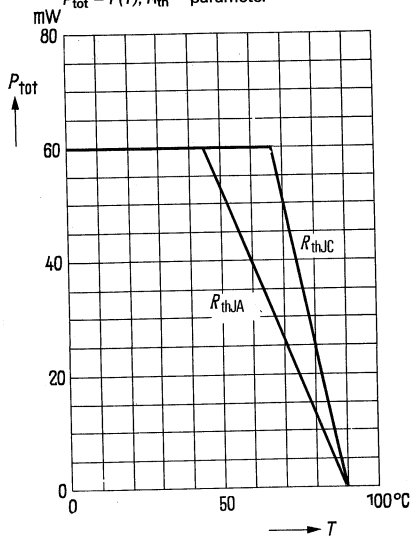

Input characteristic $I_B = f(V_{BE}); -V_{CE} = 5$ V (common emitter configuration)

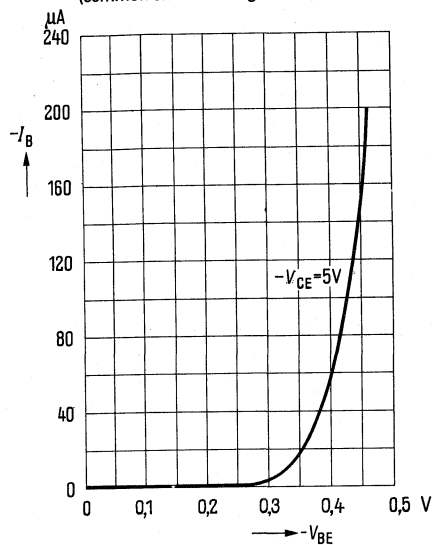

Collector current $I_C = f(I_B); -V_{CE} = 5$ V (common emitter configuration)

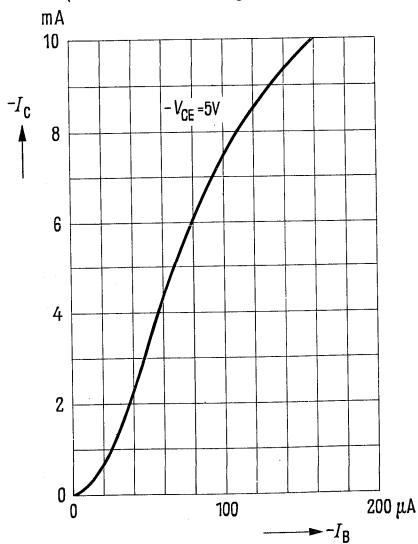

Collector current $I_C = f(V_{BE}); -V_{CE} = 5$ V (common emitter configuration)

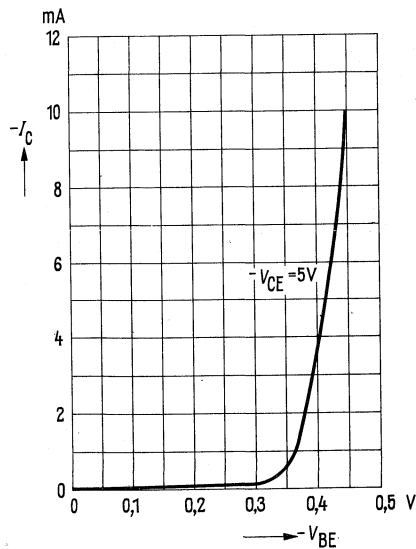

Output characteristics $I_C = f(V_{CE})$;
 $I_B = \text{parameter}$
 (common emitter configuration)

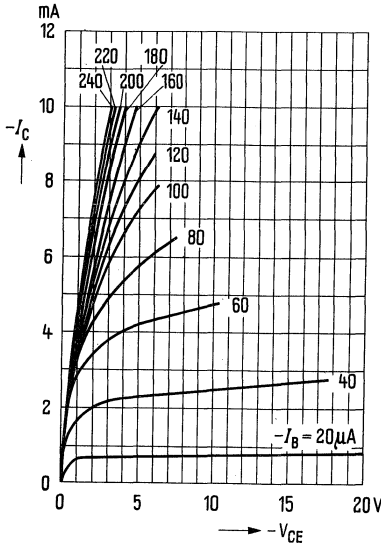

Output characteristics $I_C = f(V_{CB})$;
 $I_E = \text{parameter}$
 (common base configuration)

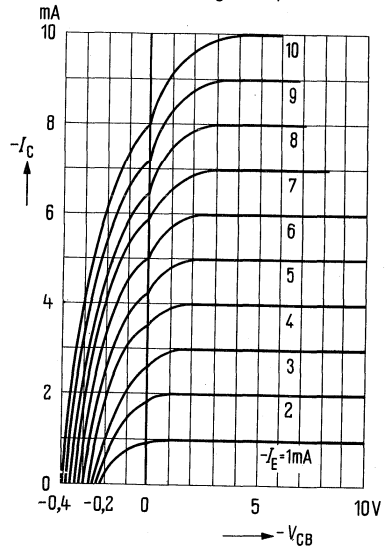

Collector cutoff current $I_{CBO} = f(T_{\text{amb}})$;
 versus temperature
 $-V_{CB0} = 20 \text{ V}$

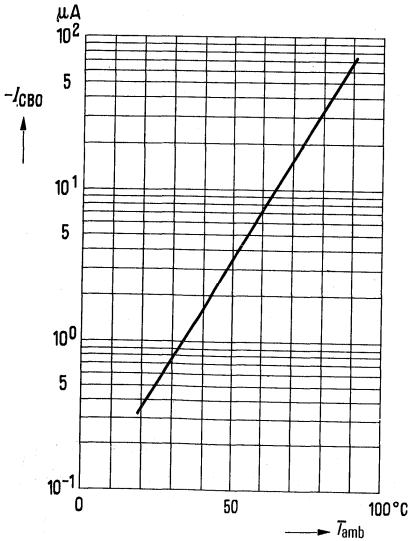

Transition frequency $f_T = f(I_C)$;
 $V_{CE} = \text{parameter}$

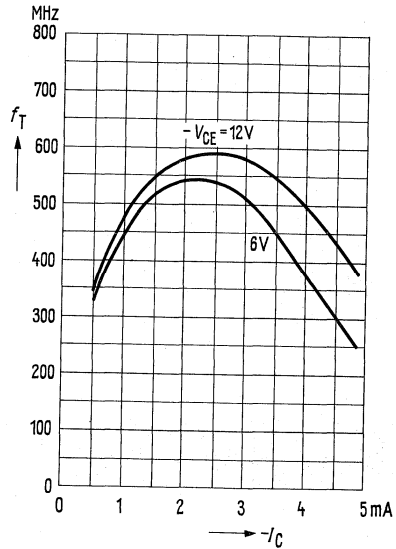

1) $V_{int 1\%}$ is the rms value of half the EMF (terminal voltage under matching condition) of a 100% sine wave modulated TV-carrier at a generator impedance of 240Ω which causes a 1% amplitude modulation on the signal carrier.

Interference voltage $V_{int 1\%} = f(I_C)$
Power gain $G_{pb} = f(I_C)$
 $f = 200 \text{ MHz}; -V_{batt} = 12 \text{ V}; R_V = 1 \text{ k}\Omega;$
 $R_L = 0.9 \text{ k}\Omega$ (common base configuration)

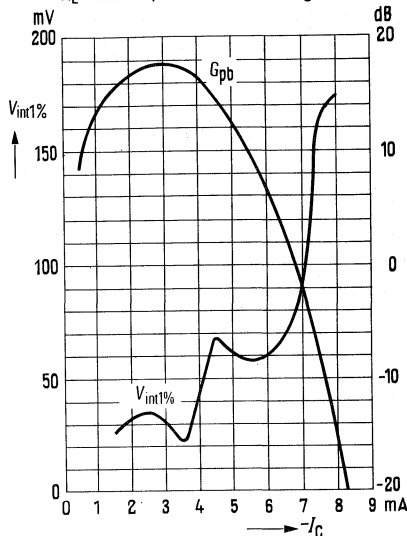

Power gain $G_{pb} = f(I_C)$
 $f = 800 \text{ MHz}; -V_{batt} = 12 \text{ V}; R_V = 1 \text{ k}\Omega$
 $R_L = 1.4 \text{ k}\Omega$
 (common base configuration)

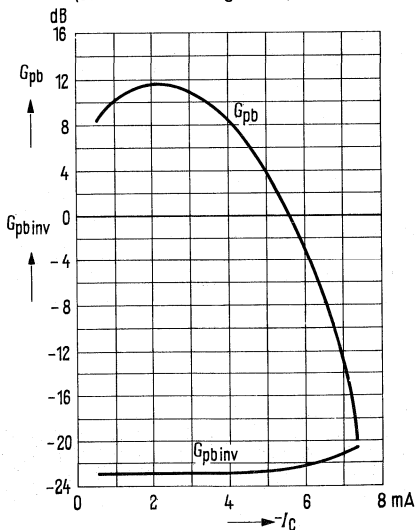

Power gain $G_{pb} = f(I_C)$
 $f = 500 \text{ MHz}; -V_{batt} = 12 \text{ V}; R_V = 1 \text{ k}\Omega$
 $R_L = 1.4 \text{ k}\Omega$
 (common base configuration)

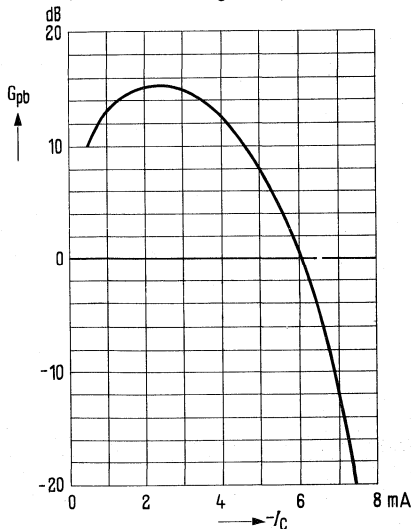

Small signal short circuit input admittance y_{11b} ; $-V_{CB} = 12\text{ V}$
(common base configuration)
measuring plane 5 mm below case bottom

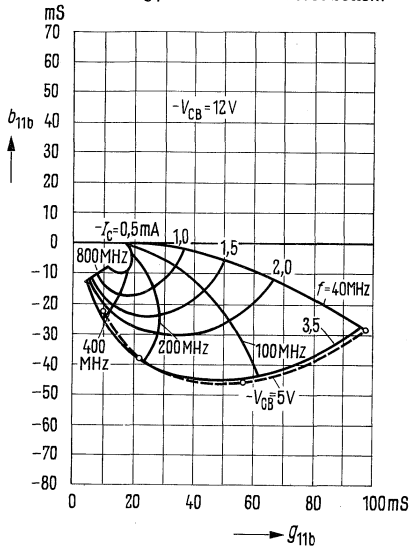

Small signal circuit reverse transfer admittance y_{12b} ; $-V_{CB} = 12\text{ V}$
(common base configuration)
measuring plane 5 mm below case bottom

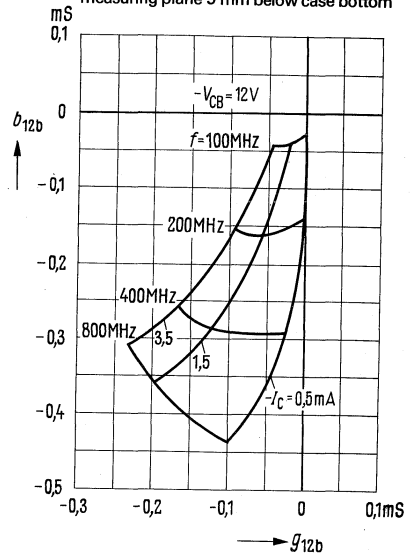

Small signal short circuit forward transfer admittance y_{21b} ; $-V_{CB} = 12\text{ V}$
(common base configuration)
measuring plane 5 mm below case bottom

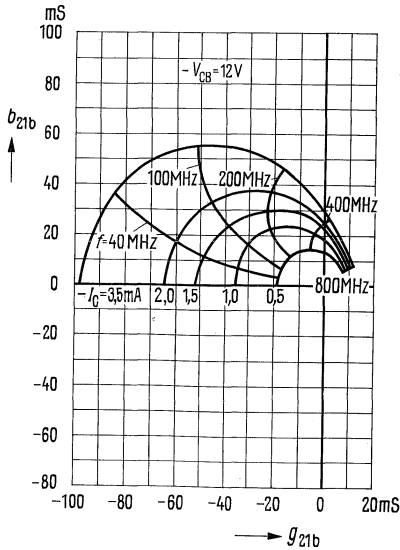

Small signal short circuit output admittance y_{22} ; $I_E = 1.5\text{ mA}$
(common emitter, base configuration)
measuring plane 5 mm below case bottom

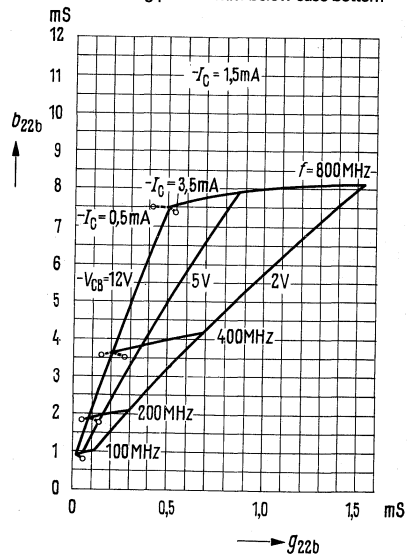

Power gain versus frequency

$G_{pbopt} = f(f)$; $-I_C = 1.5 \text{ mA}$; $-V_{CE} = 12 \text{ V}$
(common base configuration)

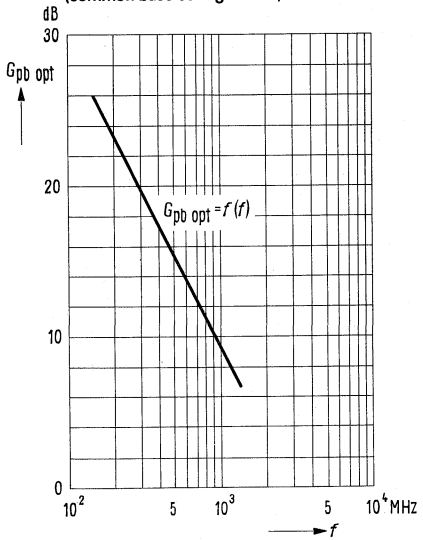

Noise figure versus frequency $NF = f(f)$

$-V_{CE} = 12 \text{ V}$
 $-I_C = 1.5 \text{ mA}$; $R_g = 60 \Omega$

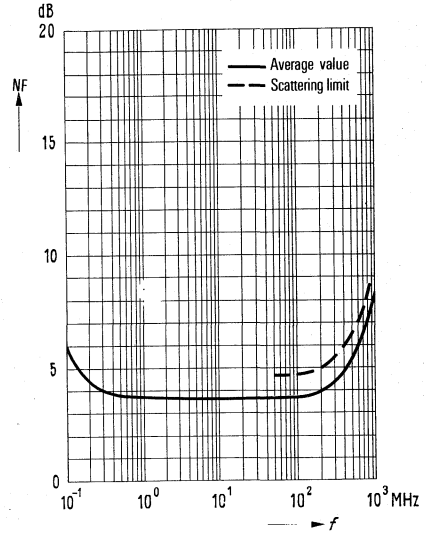

for UHF input stages up to 900 MHz

AF 239 is a germanium PNP mesa transistor in TO 72 case (18 A 4 DIN 41 876). The leads are electrically insulated from the case.

Type	Ordering code
AF 239	Q60106-X239

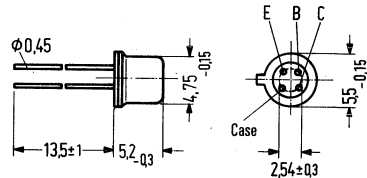

Approx. weight 0.4 g Dimensions in mm

Maximum ratings

Collector-emitter voltage	$-V_{CEO}$	15	V
Collector-emitter voltage	$-V_{CES}$	20	V
Emitter-base voltage	$-V_{EBO}$	0.3	V
Collector current	$-I_C$	10	mA
Emitter current	I_E	11	mA
Base current	$-I_B$	1	mA
Junction temperature	T_j	90	°C
Storage temperature range	T_{stg}	-30 to +75	°C
Total power dissipation ($T_{amb} = 45\text{ °C}$)	P_{tot}	60	mW

Thermal resistance

Junction to ambient air	R_{thJA}	≤ 750	K/W
Junction to case	R_{thJC}	≤ 400	K/W

Static characteristics ($T_{amb} = 25\text{ °C}$)

For the operating point, the following data applies:

$-V_{CE}$ V	$-I_C$ mA	$-I_B$ μA	h_{FE} I_C/I_B	$-V_{BE}$ mV
10	2	40	50 (>10)	350
5	5	120	42	400

Collector cutoff current ($-V_{CES} = 20\text{ V}$)	$-I_{CES}$	0.5 (<8)	μA
Collector cutoff current ($-V_{CEO} = 15\text{ V}$)	$-I_{CEO}$	<500	μA
Emitter cutoff current ($-V_{EBO} = 0.3\text{ V}$)	$-I_{EBO}$	<100	μA

Dynamic characteristics ($T_{amb} = 25^\circ\text{C}$)

Transition frequency ($-I_C = 2\text{ mA}; -V_{CE} = 10\text{ V}; f = 100\text{ MHz}$)	f_T	700	MHz
Reverse transfer capacitance ($-I_C = 2\text{ mA}; -V_{CE} = 10\text{ V}; f = 450\text{ kHz}$)	$-C_{12e}$	0.23	pF

Operating point: $-I_C = 2\text{ mA}; -V_{CB} = 10\text{ V}$

Power gain (common base configuration)

($f = 800\text{ MHz}; R_L = 500\ \Omega$)	G_{pb}	11.5 (>9)	dB
($f = 800\text{ MHz}; R_L = 2\text{ k}\Omega$)	G_{pb}	14.5 (>11.5)	dB
($f = 900\text{ MHz}; R_L = 500\ \Omega$)	G_{pb}	10.5 (≥ 8.5)	dB
($f = 900\text{ MHz}; R_L = 2\text{ k}\Omega$)	G_{pb}	12.5	dB

Noise figure

($f = 800\text{ MHz}; R_g = 60\ \Omega$)	NF	5 (<6)	dB
($f = 900\text{ MHz}; R_g = 60\ \Omega$)	NF	6 (<7)	dB

Four-pole characteristics ($-I_C = 2\text{ mA}; -V_{CE} = 10\text{ V};$ measuring plane 5 mm below case bottom) $f = 200\text{ MHz}$

$$\begin{array}{llll}
 g_{11b} = 45\text{ mS} & |y_{12b}| = 0,09\text{ mS} & |y_{21b}| = 52\text{ mS} & g_{22b} = 0,05\text{ mS} \\
 -b_{11b} = 29\text{ mS} & \varphi_{12b} = -90^\circ & \varphi_{21b} = 135^\circ & b_{22b} = 1,6\text{ mS}
 \end{array}$$

$f = 800\text{ MHz}$

$$\begin{array}{llll}
 g_{11b} = 2\text{ mS} & |y_{12b}| = 0,38\text{ mS} & |y_{21b}| = 20\text{ mS} & g_{22b} = 0,5\text{ mS} \\
 -b_{11b} = 17,5\text{ mS} & \varphi_{12b} = -100^\circ & \varphi_{21b} = 37^\circ & b_{22b} = 6,3\text{ mS}
 \end{array}$$

Test circuit for power gain and noise figure at $f = 800\text{ MHz}$

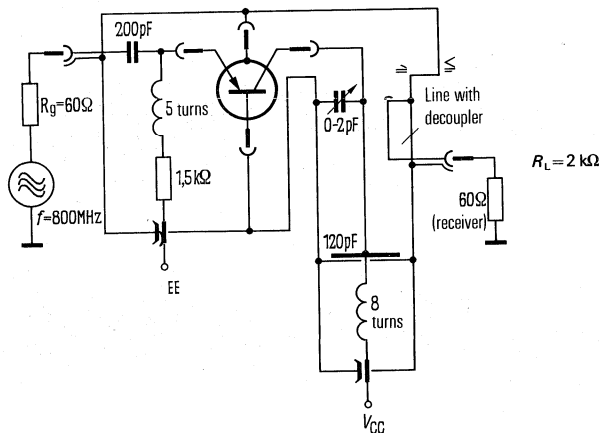

Total perm. power dissipation versus temperature
 $P_{tot} = f(T); R_{th} = \text{parameter}$

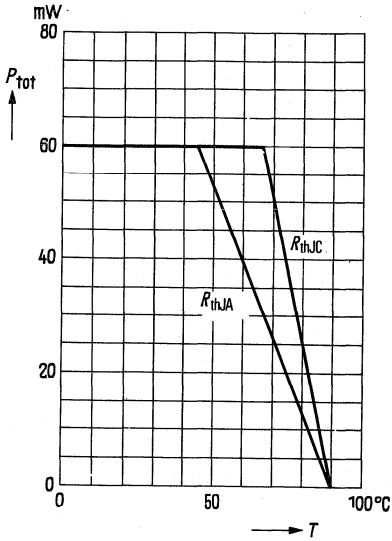

Collector cutoff current versus temperature
 $I_{CBO} = f(T_{amb})$
 $-V_{CBO} = 20 \text{ V}$

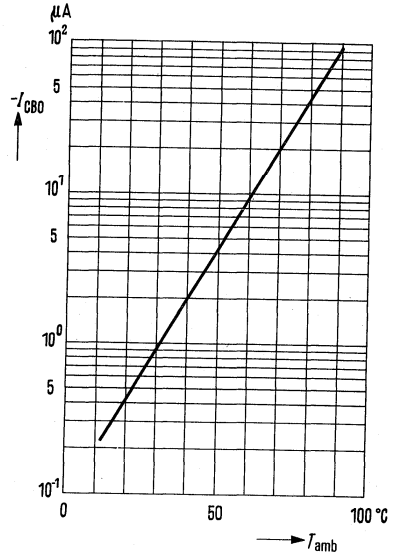

Collector current $I_C = f(I_B)$
 $V_{CE} = \text{parameter}$
 (common emitter configuration)

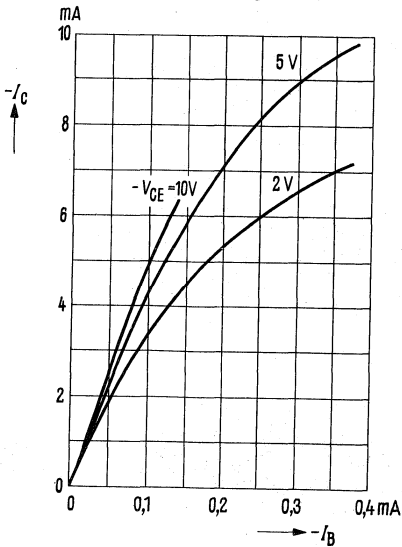

Collector current $I_C = f(V_{BE})$
 $V_{CE} = \text{parameter}$
 (common emitter configuration)

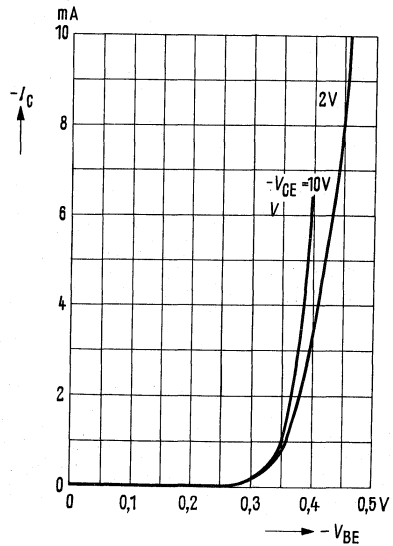

Output characteristics $I_C = f(V_{CE})$;
 $I_B = \text{parameter}$
 (common emitter configuration)

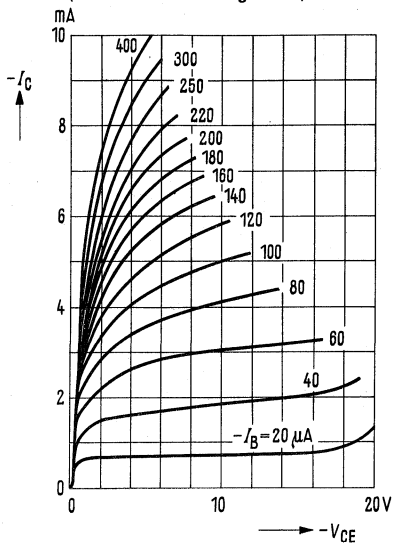

Output characteristics $I_C = f(V_{CB})$;
 $I_E = \text{parameter}$
 (common base configuration)

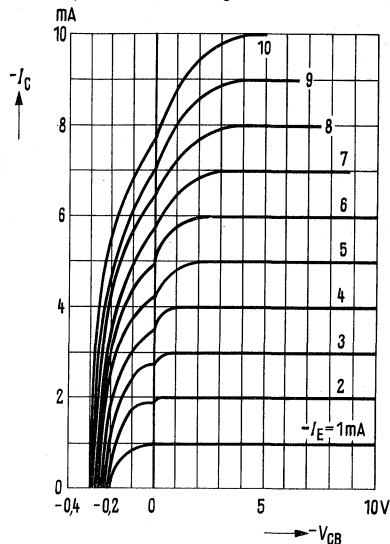

Transition frequency $f_T = f(I_C)$;
 $-V_{CE} = 10 \text{ V}; f = 100 \text{ MHz}$

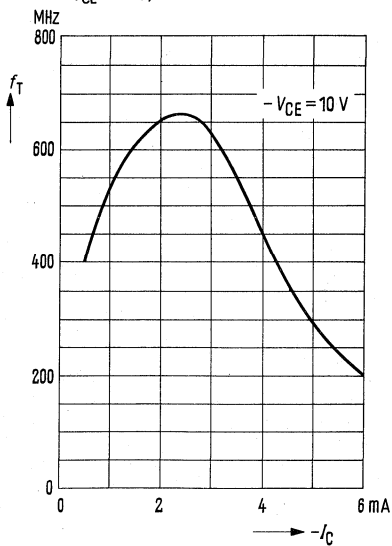

Power gain $G_{pb} = f(I_C)$;
 $f = 500 \text{ MHz}; -V_{batt} = 10 \text{ V};$
 $R_V = 1 \text{ k}\Omega; R_L = 2 \text{ k}\Omega$
 (common base configuration)

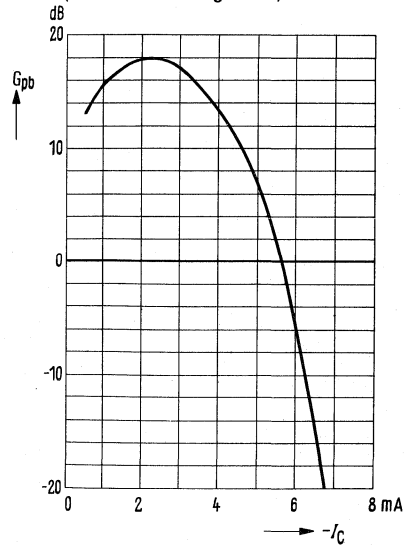

Power gain $G_{pb} = f(I_C)$
 $f = 800 \text{ MHz}; -V_{batt} = 10 \text{ V}; R_V = 1 \text{ k}\Omega;$
 $R_L = 500 \Omega$
 (common base configuration)

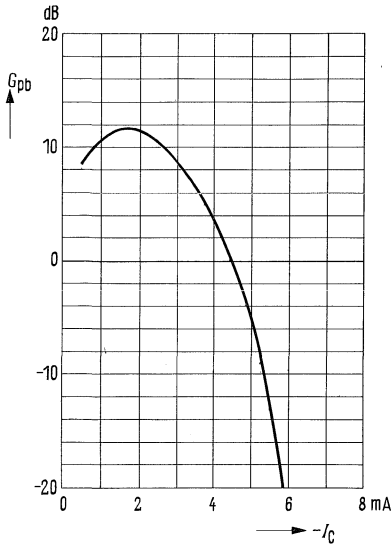

Power gain $G_{pb} = f(I_C)$
 $f = 800 \text{ MHz}; -V_{batt} = 10 \text{ V}$
 $R_V = 1 \text{ k}\Omega; R_L = 2 \text{ k}\Omega$
 (common base configuration)

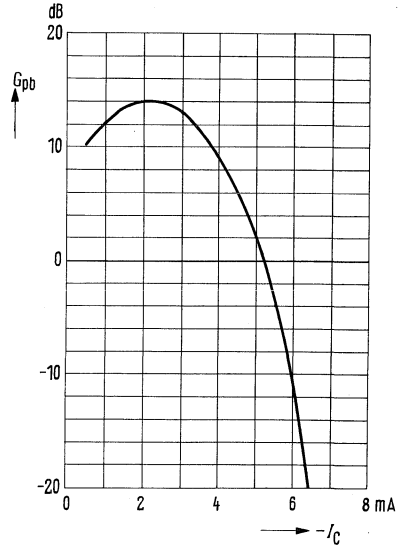

Noise figure versus frequency $NF = f(f)$
 $-V_{CB} = 10 \text{ V};$
 $-I_C = 2 \text{ mA}; R_g = 60 \Omega$

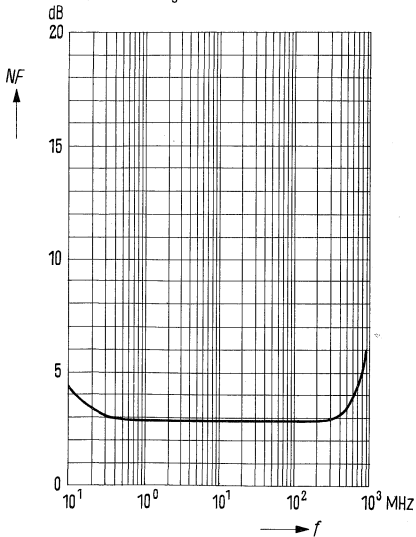

Small signal short circuit input admittance y_{11b} ; $-V_{CB} = 10\text{ V}$
 (common base configuration)
 measuring plane 5 mm below case bottom

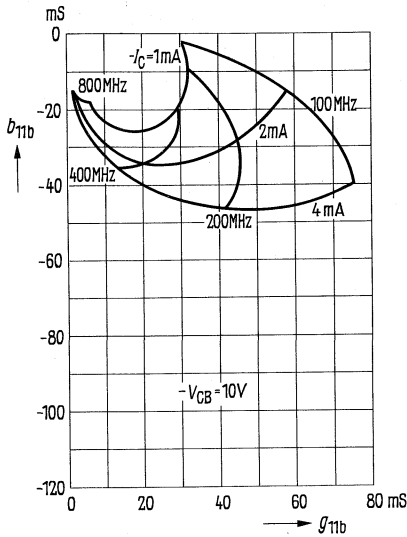

Small signal circuit reverse transfer admittance y_{12b} ; $-V_{CB} = 10\text{ V}$
 (common base configuration)
 measuring plane 5 mm below case bottom

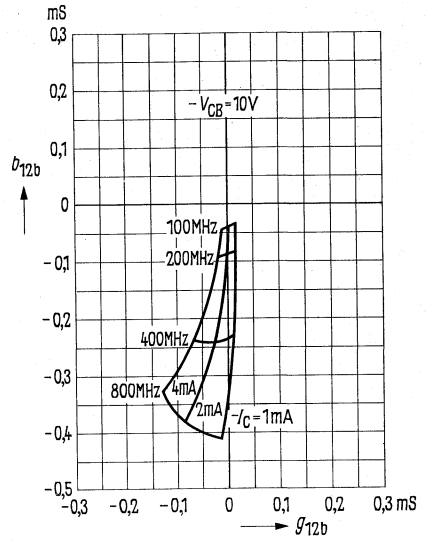

Small signal short circuit forward transfer admittance y_{21b} ; $-V_{CB} = 10\text{ V}$
 (common base configuration)
 measuring plane 5 mm below case bottom

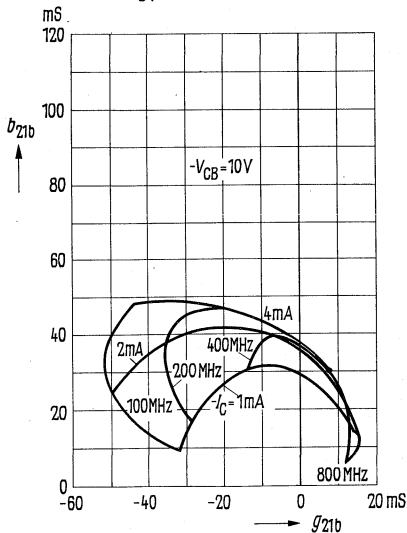

Small signal short circuit output admittance y_{22b} ; $-V_{CB} = 10\text{ V}$
 (common base configuration)
 measuring plane 5 mm below case bottom

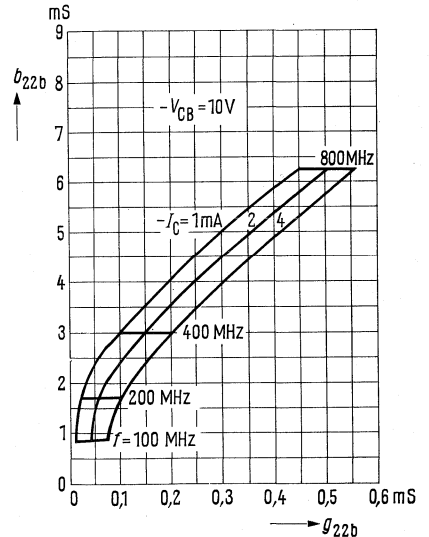

for output, mixer, and oscillator stages up to 900 MHz

AF 239 S is a germanium PNP mesa transistor in TO 72 case (18 A 4 DIN 41 876). The leads are electrically insulated from the case.

Type	Ordering code
AF 239 S	Q62701-F51

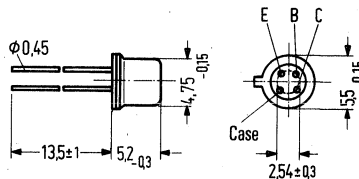

Approx. weight 0.4 g

Dimensions in mm

Maximum ratings

Collector-emitter voltage	$-V_{CEO}$	15	V
Collector-emitter voltage	$-V_{CES}$	20	V
Emitter-base voltage	$-V_{EBO}$	0.3	V
Collector current	$-I_C$	10	mA
Emitter current	I_E	11	mA
Base current	$-I_B$	1	mA
Junction temperature	T_j	90	°C
Storage temperature range	T_{stg}	-30 to +75	°C
Total power dissipation ($T_{amb} \leq 45^\circ\text{C}$)	P_{tot}	60	mW

Thermal resistance

Junction to ambient air	R_{thJA}	≤ 750	K/W
Junction to case	R_{thJC}	≤ 400	K/W

Static characteristics ($T_{amb} = 25^{\circ}\text{C}$)

$-V_{CE}$ V	I_C mA	$-I_B$ μA	h_{FE} I_C/I_B	$-V_{BE}$ mV
10	2	40	50 (> 10)	350
5	5	110	45	400

Collector cutoff current ($-V_{CES} = 20\text{ V}$)	$-I_{CES}$	0.5 (< 8)	μA
Collector cutoff current ($-V_{CEO} = 15\text{ V}$)	$-I_{CEO}$	< 500	μA
Emitter cutoff current ($-V_{EBO} = 0.3\text{ V}$)	$-I_{EBO}$	< 100	μA

Dynamic characteristics ($T_{amb} = 25^{\circ}\text{C}$)

Transition frequency ($-I_C = 2\text{ mA}; -V_{CE} = 10\text{ V}; f = 100\text{ MHz}$)	f_T	780	MHz
Reverse transfer capacitance ($-I_C = 2\text{ mA}; -V_{CE} = 10\text{ V}; f = 450\text{ kHz}$)	$-C_{12e}$	0.2	pF
Power gain			
Operating point: $-I_C = 2\text{ mA}; -V_{CE} = 10\text{ V}$			
($f = 800\text{ MHz}; R_L = 500\ \Omega$)	G_{pb}	12.5	dB
($f = 800\text{ MHz}; R_L = 2\text{ k}\Omega$)	G_{pb}	15 (> 12.5)	dB
($f = 900\text{ MHz}; R_L = 500\ \Omega$)	G_{pb}	12	dB
Noise figure			
($f = 800\text{ MHz}; R_g = 60\ \Omega$)	NF	< 5	dB
($f = 900\text{ MHz}; R_g = 60\ \Omega$)	NF	< 6	dB

Test circuit for power gain and noise figure at $f = 800\text{ MHz}$

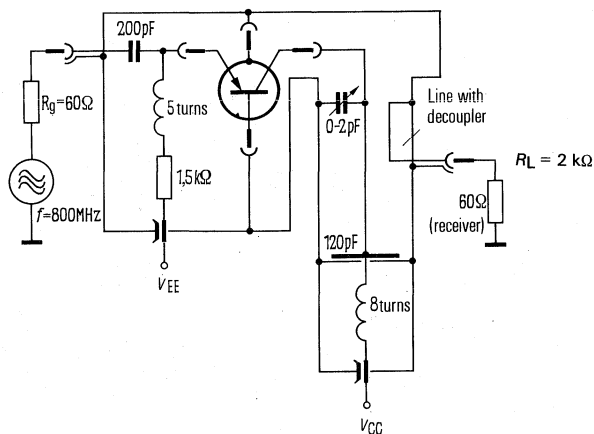

Total perm. power dissipation versus temperature $P_{tot} = f(T)$; $R_{th} = \text{parameter}$

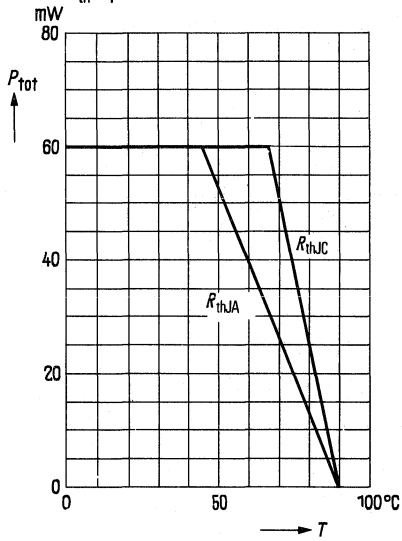

Collector cutoff current versus temperature $I_{CBO} = f(T_{amb})$; $-V_{CBO} = 20\text{ V}$

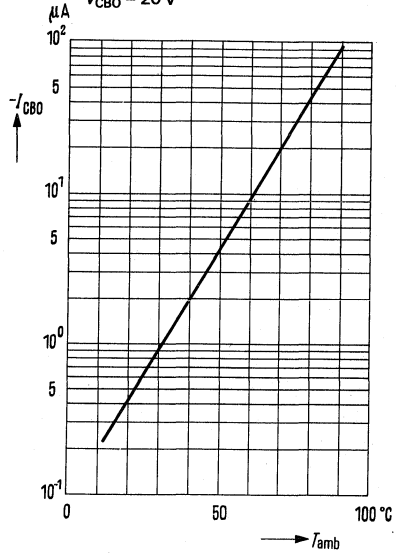

Collector current $I_C = f(V_B)$
 $V_{CE} = \text{parameter}$
(common emitter configuration)

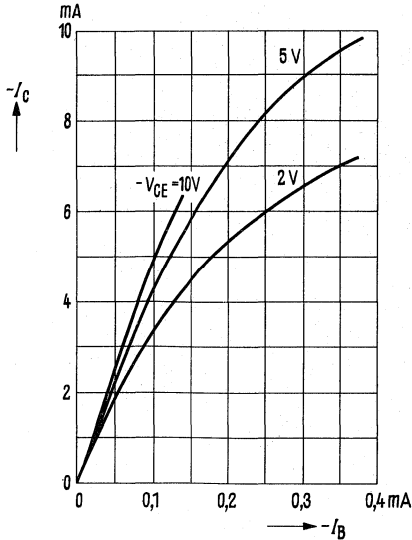

Collector current $I_C = f(V_{BE})$
 $V_{CE} = \text{parameter}$
(common emitter configuration)

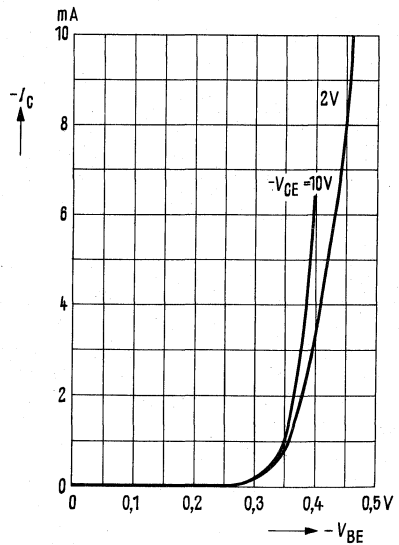

Output characteristics $I_C = f(V_{CE})$
 $I_B = \text{parameter}$
 (common emitter configuration)

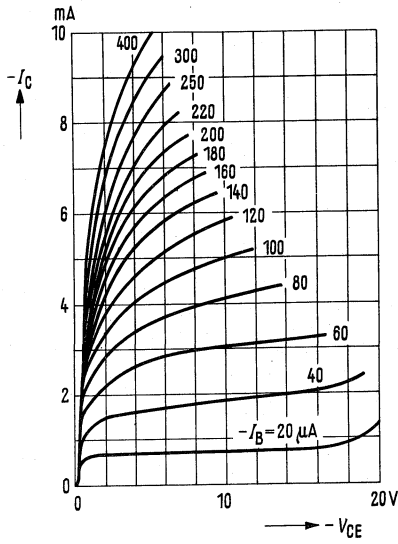

Output characteristics $I_C = f(V_{CB})$
 $I_E = \text{parameter}$
 (common base configuration)

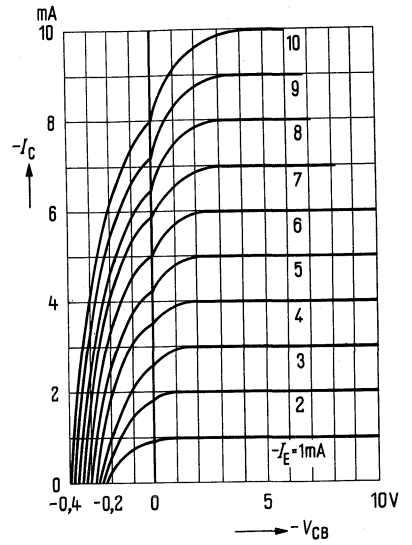

for mixer and oscillator stages up to 900 MHz

AF 240 is a germanium PNP mesa transistor in TO 72 case (18 A 4 DIN 41876). The leads are electrically insulated from the case.

Type	Ordering code
AF 240	Q60106-X240

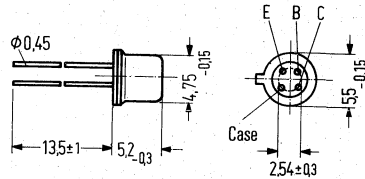

Approx. weight 0.4 g

Dimensions in mm

Maximum ratings

Collector-emitter voltage	$-V_{CEO}$	15	V
Collector-emitter voltage	$-V_{CES}$	20	V
Emitter-base voltage	$-V_{EBO}$	0.3	V
Collector current	$-I_C$	10	mA
Emitter current	I_E	11	mA
Base current	$-I_B$	1	mA
Junction temperature	T_j	90	°C
Storage temperature range	T_{stg}	-30 to +75	°C
Total power dissipation ($T_{amb} \leq 45^\circ\text{C}$)	P_{tot}	60	mW

Thermal resistance

Junction to ambient air	R_{thJA}	≤ 750	K/W
Junction to case	R_{thJC}	≤ 400	K/W

Static characteristics ($T_{amb} = 25^{\circ}\text{C}$)

$-V_{CE}$ V	$-I_C$ mA	$-I_B$ μA	h_{FE} I_C/I_B	$-V_{BE}$ mV
10	2	80	25 (>10)	370

Collector cutoff current ($-V_{CES} = 20\text{ V}$)	$-I_{CES}$	0.5 (<8)	μA
Collector cutoff current ($-V_{CEO} = 15\text{ V}$)	$-I_{CEO}$	<500	μA
Emitter cutoff current ($-V_{EBO} = 0.3\text{ V}$)	$-I_{EBO}$	<100	μA

Dynamic characteristics ($T_{amb} = 25^{\circ}\text{C}$)

Transition frequency ($-I_C = 2\text{ mA}$; $-V_{CE} = 10\text{ V}$; $f = 100\text{ MHz}$)	f_T	500	MHz
Reverse transfer capacitance ($-I_C = 1\text{ mA}$; $-V_{CE} = 10\text{ V}$; $f = 1\text{ MHz}$,	$-C_{12e}$	0.26	pF
Power gain ($-I_C = 2\text{ mA}$; $-V_{CE} = 10\text{ V}$; $f = 800\text{ MHz}$; $R_L = 2\text{ k}\Omega$)	G_{pb}	13	dB
Power gain ($-I_C = 2\text{ mA}$; $-V_{CE} = 10\text{ V}$; $f = 800\text{ MHz}$; $R_L = 500\ \Omega$)	G_{pb}	11	dB
Noise figure ($-I_C = 2\text{ mA}$; $-V_{CE} = 10\text{ V}$; $f = 800\text{ MHz}$; $R_g = 60\ \Omega$)	NF	6.5	dB
($-I_C = 2\text{ mA}$; $-V_{CE} = 10\text{ V}$; $f = 200\text{ MHz}$; $R_g = 60\ \Omega$)	NF	3	dB

Four-pole characteristics (measured at a spacing of 1 mm)

Operating point: $-I_C = 3\text{ mA}$; $-V_{CE} = 10\text{ V}$;

$f = 800\text{ MHz}$:

$g_{11b} = 4,8\text{ mS}$	$ y_{12b} = 0,31\text{ mS}$	$ y_{21b} = 22\text{ mS}$	$g_{22b} = 0,5\text{ mS}$
$b_{11b} = -25\text{ mS}$	$\varphi_{12b} = -108^{\circ}$	$\varphi_{21b} = 25^{\circ}$	$b_{22b} = 5,2\text{ mS}$

$f = 400\text{ MHz}$:

$g_{11b} = 30\text{ mS}$	$ y_{12b} = 0,25\text{ mS}$	$ y_{21b} = 51\text{ mS}$	$g_{22b} = 0,2\text{ mS}$
$b_{11b} = -46\text{ mS}$	$\varphi_{12b} = -90^{\circ}$	$\varphi_{21b} = 85^{\circ}$	$b_{22b} = 2,5\text{ mS}$

Total perm. power dissipation versus temperature $P_{tot} = f(T)$;
 R_{th} = parameter

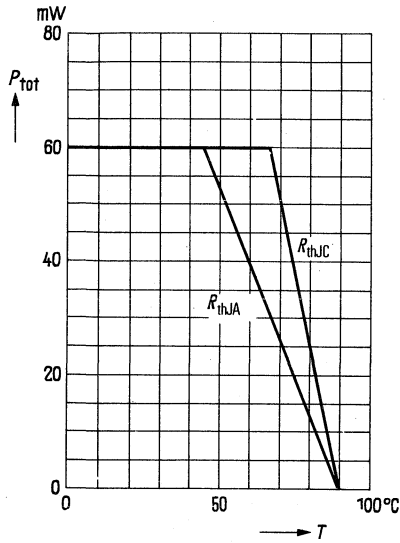

Output characteristics $I_C = f(V_{CE})$;
 I_B = parameter

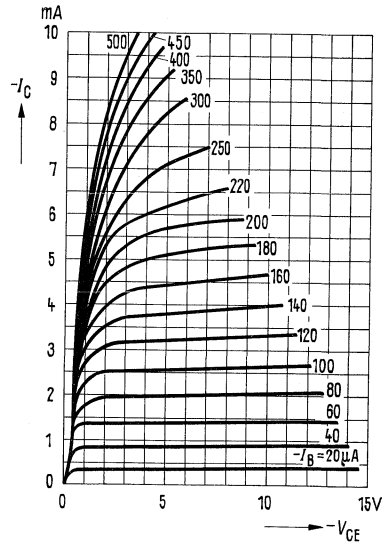

Collector cutoff current versus temperature $I_{CBO} = f(T_{amb})$; $-V_{CE} = 20 V$

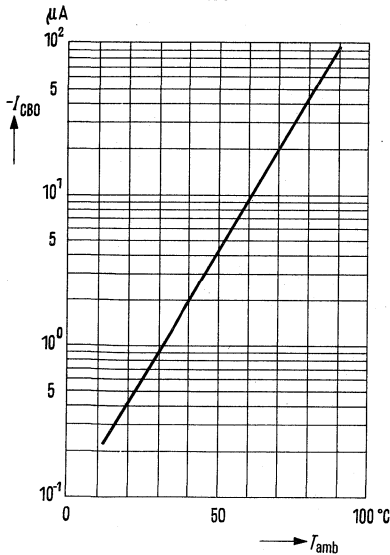

Transition frequency $f_T = f(I_C)$
 $-V_{CE}$ = parameter; $f = 100 MHz$

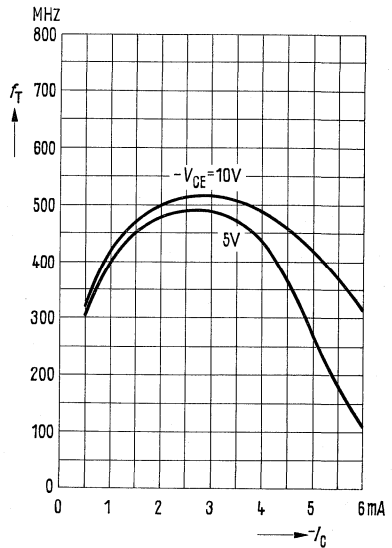

for input stages up to 900 MHz

AF 279 S is a germanium PNP UHF planar transistor with passivated surface in low-capacitance 50 B 3 DIN 41867 plastic package similar to TO 119. This transistor is particularly intended for use in low-noise regulated input stages up to 900 MHz in diode-tuned tuners.

Type	Ordering code
AF 279 S	Q62701-F87

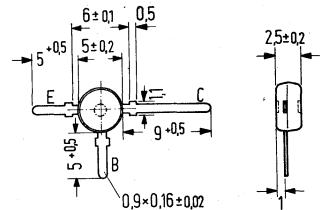

Approx. weight 0.25 g

Dimensions in mm

Maximum ratings

Collector-emitter voltage	$-V_{CEO}$	15	V
Collector-emitter voltage	$-V_{CES}$	20	V
Emitter-base voltage	$-V_{EBO}$	0.3	V
Collector current	$-I_C$	10	mA
Emitter current	I_E	11	mA
Base current	$-I_B$	1	mA
Junction temperature	T_j	90	°C
Storage temperature range	T_{stg}	-30 to +75	°C
Total power dissipation	P_{tot}	60	mW

Thermal resistance

Junction to ambient air	R_{thJA}	≤ 600	K/W
-------------------------	------------	-------	-----

Static characteristics ($T_{amb} = 25^{\circ}\text{C}$)

$-V_{CE}$ V	$-I_C$ mA	$-I_B$ μA	h_{FE} I_C/I_B	$-V_{BE}$ mV
10	2	40	50 (<10)	350
5	5	110	45	400

Collector cutoff current ($-V_{CES} = 20\text{ V}$)	$-I_{CES}$	1 (<15)	μA
Collector cutoff current ($-V_{CEO} = 15\text{ V}$)	$-I_{CEO}$	<500	μA
Emitter cutoff current ($-V_{EBO} = 0.3\text{ V}$)	$-I_{EBO}$	<100	μA

Dynamic characteristics ($T_{amb} = 25^{\circ}\text{C}$)

Transition frequency ($-I_C = 2\text{ mA}$; $-V_{CE} = 10\text{ V}$; $f = 100\text{ MHz}$)	f_T	820	MHZ
Collector base capacitance ($-V_{CB} = 10\text{ V}$; $f = 1\text{ MHz}$)	$-C_{CB0}$	0.4	pF
Power gain ($-I_C = 2\text{ mA}$; $-V_{CE} = 10\text{ V}$; $f = 800\text{ MHz}$; $R_L = 2\text{ k}\Omega$)	G_{pb}	20	dB
($-I_C = 2\text{ mA}$; $-V_{CE} = 10\text{ V}$; $f = 900\text{ MHz}$; $R_L = 500\Omega$)	G_{pb}	12	dB
Noise figure ($-I_C = 2\text{ mA}$; $-V_{CE} = 10\text{ V}$; $f = 800\text{ MHz}$; $R_g = 60\Omega$)	NF	<4.5	dB

Four-pole characteristics:

$-I_C = 2\text{ mA}$; $-V_{CE} = 10\text{ V}$; $f = 800\text{ MHz}$ (measured at a spacing of 1.5 mm)

$g_{11b} = 23\text{ mS}$	$ y_{12b} = 0,6\text{ mS}$	$ y_{21b} = 38\text{ mS}$	$g_{22b} = 0,3\text{ mS}$
$-b_{11b} = 33\text{ mS}$	$\phi_{12b} = -90^{\circ}$	$\phi_{21b} = 75^{\circ}$	$b_{22b} = 2,5\text{ mS}$

Test circuit for power gain and noise figure at $f = 800\text{ MHz}$

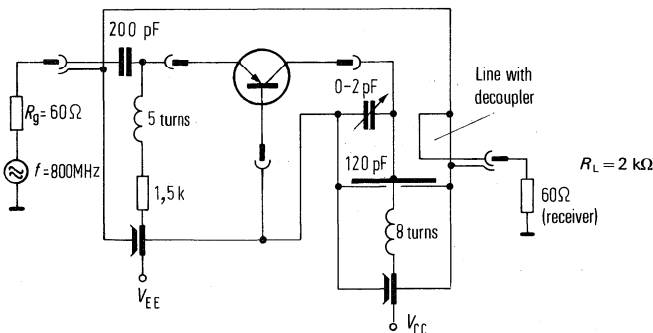

for mixer and oscillator circuits up to 900 MHz

AF 280 S is a germanium PNP UHF planar transistor with passivated surface in low-capacitance 50 B 3 DIN 41867 plastic package similar to TO 119. This transistor is particularly intended for use in mixer and oscillator circuits up to 900 MHz in diode tuned tuners.

Type	Ordering code
AF 280 S	Q62701-F88

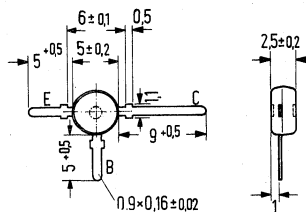

Approx. weight 0.25 g Dimensions in mm

Maximum ratings

Collector-emitter voltage	$-V_{CE0}$	15	V
Collector-emitter voltage	$-V_{CES}$	20	V
Emitter-base voltage	$-V_{EBO}$	0.3	V
Collector current	$-I_C$	10	mA
Emitter current	I_E	11	mA
Base current	$-I_B$	1	mA
Junction temperature	T_j	90	°C
Storage temperature range	T_{stg}	-30 to +75	°C
Total power dissipation	P_{tot}	60	mW

Thermal resistance

Junction to ambient air	R_{thJA}	≤ 600	K/W
-------------------------	------------	-------	-----

Static characteristics ($T_{amb} = 25^\circ\text{C}$)

$-V_{CE}$ V	$-I_C$ mA	$-I_B$ μA	h_{FE} I_C/I_B	$-V_{BE}$ mV
10	2	80	25 (>8)	370

Collector cutoff current ($-V_{CES} = 20\text{ V}$)	$-I_{CES}$	1 (<15)	μA
Collector cutoff current ($-V_{CE0} = 15\text{ V}$)	$-I_{CE0}$	< 500	μA
Emitter cutoff current ($-V_{EBO} = 0.3\text{ V}$)	$-I_{EBO}$	< 100	μA

Dynamic characteristics ($T_{amb} = 25^{\circ}\text{C}$)

Transition frequency ($-I_C = 2 \text{ mA}; -V_{CE} = 10 \text{ V};$
 $f = 100 \text{ MHz}$)

Collector-base capacitance
 ($-V_{CB} = 10 \text{ V}; f = 1 \text{ MHz}$)

Power gain
 ($-I_C = 2 \text{ mA}; -V_{CE} = 10 \text{ V}; f = 800 \text{ MHz};$
 $R_L = 2 \text{ k}\Omega$)

Power gain
 ($-I_C = 2 \text{ mA}; -V_{CE} = 10 \text{ V}; f = 800 \text{ MHz};$
 $R_L = 500 \Omega$)

Noise figure
 ($-I_C = 2 \text{ mA}; -V_{CE} = 10 \text{ V}; f = 800 \text{ MHz};$
 $R_g = 60 \Omega$)

Noise figure
 ($-I_C = 2 \text{ mA}; -V_{CE} = 10 \text{ V}; f = 200 \text{ MHz};$
 $R_g = 60 \Omega$)

f_T	550	MHz
$-C_{CB0}$	0.42	pF
G_{pb}	16.5	dB
G_{pb}	14.5	dB
NF	6	dB
NF	2.6	dB

Four-pole characteristics:

$-I_C = 3 \text{ mA}; -V_{CE} = 10 \text{ V}$ (measured at a spacing of 1.5 mm)
 $f = 200 \text{ MHz}$:

$g_{11b} = 94 \text{ mS}$ $|y_{12b}| = 0,15 \text{ mS}$ $|y_{21b}| = 88 \text{ mS}$ $g_{22b} = 0,02 \text{ mS}$
 $-b_{11b} = 32 \text{ mS}$ $\varphi_{12b} = -90^{\circ}$ $\varphi_{21b} = 144^{\circ}$ $b_{22b} = 0,6 \text{ mS}$

$f = 800 \text{ MHz}$:

$g_{11b} = 22 \text{ mS}$ $|y_{12b}| = 0,6 \text{ mS}$ $|y_{21b}| = 37 \text{ mS}$ $g_{22b} = 0,5 \text{ mS}$
 $-b_{11b} = 46 \text{ mS}$ $\varphi_{12b} = -100^{\circ}$ $\varphi_{21b} = 48^{\circ}$ $b_{22b} = 3 \text{ mS}$

Test circuit for power gain and noise figure at $f = 800 \text{ MHz}$

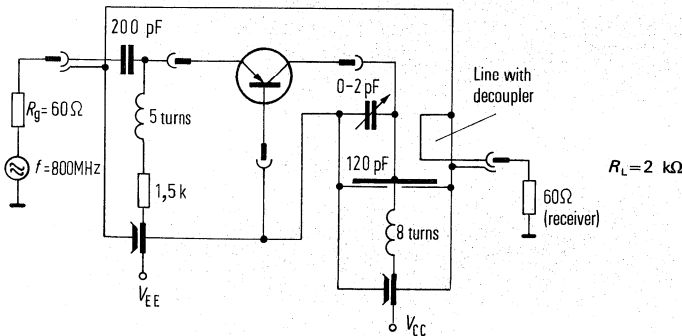

AF 289 is a germanium PNP UHF planar transistor with passivated surface in low-capacitance 50 B 3 DIN 41867 plastic package similar to TO 119. This transistor is particularly intended for use in low-noise regulated input stages up to 950 MHz in diode-tuned tuners.

Type	Ordering code
AF 289	Q62701-F92

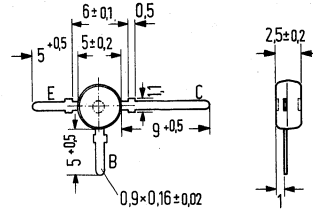

Approx. weight 0.25 g Dimensions in mm

Maximum ratings

- Collector-emitter voltage
- Collector-base voltage
- Emitter-base voltage
- Collector current
- Emitter current
- Base current
- Junction temperature
- Storage temperature range
- Total power dissipation

$-V_{CEO}$	15	V
$-V_{CBO}$	20	V
$-V_{EBO}$	0.3	V
$-I_C$	10	mA
I_E	11	mA
$-I_B$	1	mA
T_j	96	°C
T_{stg}	-30 to +75	°C
P_{tot}	60	mW

Thermal resistance

- Junction to ambient air

R_{thJA}	< 600	K/W
------------	-------	-----

Static characteristics ($T_{amb} = 25^{\circ}\text{C}$)

DC current gain

($-I_C = 2 \text{ mA}$; $-V_{CE} = 10 \text{ V}$)

Collector cutoff current

($-V_{CBO} = 20 \text{ V}$)

h_{FE}	30 (> 12)	-
I_{CBO}	< 15	μA

Dynamic characteristics ($T_{amb} = 25^{\circ}\text{C}$)

Transition frequency

($-I_C = 3 \text{ mA}$; $-V_{CE} = 10 \text{ V}$; $f = 100 \text{ MHz}$)

Reverse transfer capacitance

($-V_{CE} = 1 \text{ V}$; $f = 1 \text{ MHz}$)

Collector-base capacitance

($-V_{CB} = 10 \text{ V}$; $f = 1 \text{ MHz}$)

Power gain

($-I_C = 3 \text{ mA}$; $-V_{CB} = 10 \text{ V}$; $f = 800 \text{ MHz}$; $R_L = 2 \text{ k}\Omega$)

Power gain

($-I_C = 3 \text{ mA}$; $-V_{CB} = 10 \text{ V}$; $f = 800 \text{ MHz}$; $R_L = 500 \text{ k}\Omega$)

Collector current for max. power gain

($V_{CC} = 12 \text{ V}$; $R_{CC} = 1 \text{ k}\Omega$; $f = 800 \text{ MHz}$)

Noise figure

($-I_C = 3 \text{ mA}$; $-V_{CB} = 10 \text{ V}$; $f = 800 \text{ MHz}$; $R_g = 60 \Omega$)Min. interference voltage¹⁾($-V_{CC} = 12 \text{ V}$; $R_{CC} = 1 \text{ k}\Omega$; $f_M = 200 \text{ MHz}$; $R_g = 75 \Omega$ $R_L = 900 \Omega$)

f_T	950	MHz
C_{12b}	50	fF
$-C_{CBO}$	0.4	pF
G_{pb}	19	dB
G_{pb}	12.5	dB
$I_{CGpbmax}$	> 3	mA
NF	3.4 (< 4.5)	dB
$V_{int1\%}$	20	mV

1) $V_{int 1\%}$ is the rms value of half the EMF of a 100% sine-wave modulated TV carrier with a generator resistance of 75Ω which causes 1% amplitude modulation on the signal carrier.

for large signal applications up to 900 MHz

AF 379 is a PNP germanium planar RF transistor in 50 B 3 DIN 41867 plastic package similar to TO 119. The transistor is particularly intended for non-regulated input stages of low cross modulation for use in TV tuners.

Type	Ordering code
AF 379	Q62701-F72

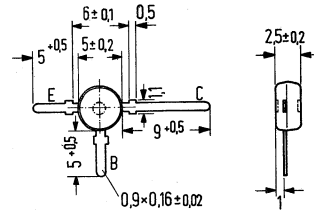

Approx. weight 0.25 g Dimensions in mm

Maximum ratings

- Collector-emitter voltage
- Collector-emitter voltage ($R_{BE} \leq 500 \Omega$)
- Emitter-base voltage
- Collector current
- Emitter current
- Junction temperature
- Storage temperature range
- Total power dissipation ($T_{amb} \leq 45^\circ\text{C}$)¹⁾

$-V_{CEO}$	13	V
$-V_{CER}$	20	V
$-V_{EBO}$	0.3	V
$-I_C$	20	mA
I_E	20	mA
T_j	90	$^\circ\text{C}$
T_{stg}	-30 to +75	$^\circ\text{C}$
P_{tot}	100	mW

Thermal resistance

- Junction to case

R_{thJC}	≤ 450	K/W
------------	------------	-----

Static characteristics ($T_{amb} = 25^\circ\text{C}$)

- Collector-emitter breakdown voltage
- ($-I_C = 500 \mu\text{A}$)
- ($-I_C = 100 \mu\text{A}; R_{BE} = 500 \Omega$)
- Emitter-base breakdown voltage
- ($I_E = 100 \mu\text{A}$)
- Collector cutoff current
- ($-V_{CB} = 20 \text{ V}$)
- DC current gain
- ($-I_C = 8 \text{ mA}; -V_{CE} = 8 \text{ V}$)

$-V_{(BR)CEO}$	> 13	V
$-V_{(BR)CER}$	> 20	V
$-V_{(BR)EBO}$	> 0.3	V
$-I_{CBO}$	< 15	μA
h_{FE}	80 (> 25)	-

1) Heat dissipation via the soldered joint of the built-in collector

Dynamic characteristics ($T_{amb} = 25^{\circ}\text{C}$)

Transition frequency

($-I_C = 8 \text{ mA}$; $-V_{CE} = 8 \text{ V}$; $f = 100 \text{ MHz}$)

Output capacitance

($-V_{CB} = 8 \text{ V}$; $f = 1 \text{ MHz}$)

Noise figure

($-I_C = 2 \text{ mA}$; $-V_{CE} = 10 \text{ V}$; $f = 200 \text{ MHz}$);

$R_g = 60 \Omega$)

($-I_C = 8 \text{ mA}$; $-V_{CE} = 8 \text{ V}$; $f = 800 \text{ MHz}$;

$R_g = 60 \Omega$)

Interference voltage¹⁾

($-I_C = 8 \text{ mA}$; $-V_{CE} = 8 \text{ V}$; $f = 200 \text{ MHz}$;

$R_g = 60 \Omega$)

Power gain

($-I_C = 8 \text{ mA}$; $-V_{CE} = 8 \text{ V}$; $f = 800 \text{ MHz}$;

$R_g = 60 \Omega$; $R_L = 2 \text{ k}\Omega$)

f_T	1250	MHz
C_{ob}	0.6	pF
NF	2.5	dB
NF	5	dB
$V_{int1\%}$	250	mV
G_{pb}	18	dB

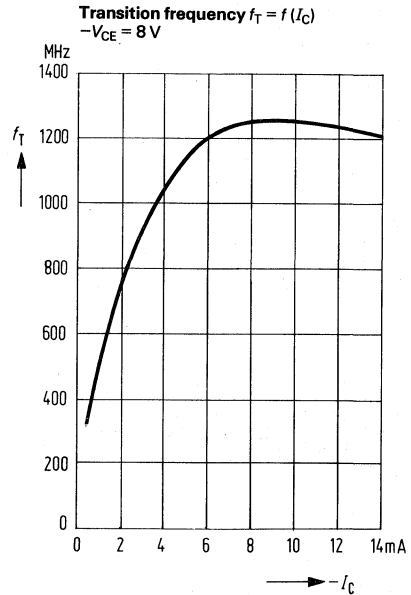

1) $V_{int 1\%}$ is the rms value of the EMF of a 100% sine-wave modulated TV carrier with a generator resistance of 60Ω which causes 1% amplitude modulation on the signal carrier.

ASY 48 and ASY 70 are alloyed germanium PNP transistors in 1 A 3 DIN 41871 case (similar to TO 1). The leads are electrically insulated from the case. The collector terminal is marked by a red dot at the edge of the case. The transistors are particularly suitable for switching applications.

Not for new design

Type	Ordering code
ASY 48 ¹⁾	Q60118-Y82
ASY 48 IV	Q60118-Y48-D
ASY 48 V	Q60118-Y48-E
ASY 48 VI	Q60118-Y48-F
ASY 70 ¹⁾	Q60118-Y81
ASY 70 IV	Q60118-Y70-D
ASY 70 V	Q60118-Y70-E
ASY 70 VI	Q60118-Y70-F
Heat sink	Q62901-B1

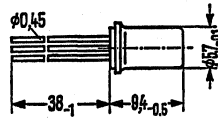

Approx. weight 1 g

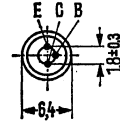

Dimensions in mm

Maximum ratings

Collector-emitter voltage	$-V_{CE0}$	45	30	V
Collector-emitter voltage ($V_{BE} \geq 0.2$ V)	$-V_{CEV}$	64	32	V
Collector-base voltage	$-V_{CBO}$	64	32	V
Emitter-base voltage	$-V_{EBO}$	16	16	V
Collector current	$-I_C$	300	300	mA
Base current	$-I_B$	60	60	mA
Junction temperature	T_j	90	90	°C
Storage temperature range	T_{stg}	-55 to +75	-55 to +75	°C
Total power dissipation ($T_{case} = 45$ °C)	P_{tot}	900	900	mW

	ASY 48	ASY 70	
$-V_{CE0}$	45	30	V
$-V_{CEV}$	64	32	V
$-V_{CBO}$	64	32	V
$-V_{EBO}$	16	16	V
$-I_C$	300	300	mA
$-I_B$	60	60	mA
T_j	90	90	°C
T_{stg}	-55 to +75	-55 to +75	°C
P_{tot}	900	900	mW

Thermal resistance

Junction to ambient air	R_{thJA}	≤ 300	≤ 300	K/W
Junction to case	R_{thJC}	≤ 50	≤ 50	K/W

Static characteristics ($T_{amb} = 25$ °C)

	ASY 48	ASY 70		
Collector cutoff current ($-V_{CBO} = 10$ V)	$-I_{CBO}$	< 10	3 (< 10)	μA
Collector cutoff current ($-V_{CBO} = 32$ V)	$-I_{CBO}$	-	5 (< 18)	μA
Collector cutoff current ($-V_{CBO} = 64$ V)	$-I_{CBO}$	6 (< 18)	-	μA
Emitter cutoff current ($-V_{EBO} = 5$ V)	$-I_{EBO}$	-	3	μA
Emitter cutoff current ($-V_{EBO} = 16$ V)	$-I_{EBO}$	4 (< 18)	4 (< 18)	μA
Collector cutoff current ($-V_{CEV} = 32$ V; $V_{BE} \geq 0.2$ V)	$-I_{CEV}$	-	5 (< 18)	μA
Collector cutoff current ($-V_{CEV} = 64$ V; $V_{BE} \geq 0.2$ V)	$-I_{CEV}$	6 (< 18)	-	μA
Collector-emitter saturation voltage ($I_C = 300$ mA; $I_B = 15$ mA)	$-V_{CEsat}$	0.15 (< 0.25)	0.15 (< 0.25)	V

1) If the order does not include any exact indication of the current amplification group desired, a transistor of a current amplification group just available from stock will be delivered.

Static characteristics ($T_{amb} = 25^{\circ}\text{C}$)

The transistors are grouped according to the DC current gain h_{FE} at $-I_C = 100\text{ mA}$ and are marked by Roman numerals.

h_{FE} group		IV	V	VI	
$-I_C$ mA	$-V_{CE}$ V	h_{FE} I_C/I_B	h_{FE} I_C/I_B	h_{FE} I_C/I_B	$-V_{BE}$ V
2	0.5	47	79	114	0.13 (<0.20)
100	0.5	45 (30 to 60)	75 (50 to 100)	110 (75 to 150)	0.32 (<0.55)
300	0.5	35	58	86	0.44 (<0.80)

Dynamic characteristics ($T_{amb} = 25^{\circ}\text{C}$)

Transition frequency $-I_C = 5\text{ mA}$; $-V_{CE} = 5\text{ V}$

Base intrinsic resistance

Collector-base capacitance $-V_{CBO} = 5\text{ V}$

Switching times

Current selection

Operating point: $-I_C = 100\text{ mA}$;

$\dot{u} = 1.5$ to 3 ; $a = 1$ to 2 ;

$-V_{CC} = 10\text{ V}$

Voltage selection

Operating point: $-I_C = 100\text{ mA}$;

$-V_{BBE1} = 4\text{ V}$; $V_{BBE2} = 1\text{ V}$;

$R_{BB} = 100\ \Omega$

	ASY 48	ASY 70	
f_T	1.2	1.5	MHz
$r_{bb'}$	75 (<200)	75 (<200)	Ω
C_{CBO}	25 (<40)	25 (<40)	pF
t_{on}	3.5 (<10)	3.5 (<10)	μs
t_s	1.1 (<3)	1.1 (<3)	μs
t_f	2.1 (<7)	2.1 (<7)	μs
t_{on}	0.25 (<1)	0.15 (<1)	μs
t_s	1.3 (<2.5)	1.3 (<2.5)	μs
t_f	0.5 (<1.5)	0.5 (<1.5)	μs

Total perm. power dissipation versus temperature $P_{tot} = f(T)$; $R_{th} = \text{parameter}$

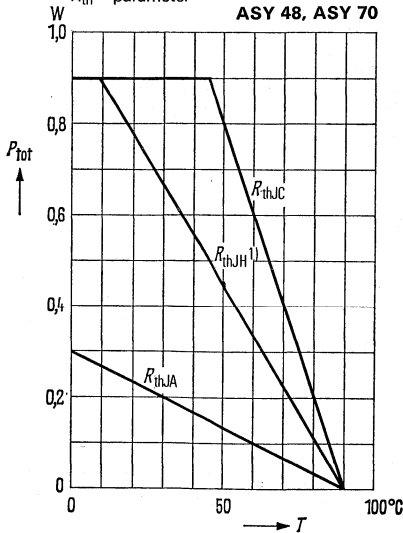

1) Heat sink aluminum $12.5\text{ cm}^2 \times 2\text{ mm}$

Permissible pulse load $t_{thJC} = f(t)$ v = parameter

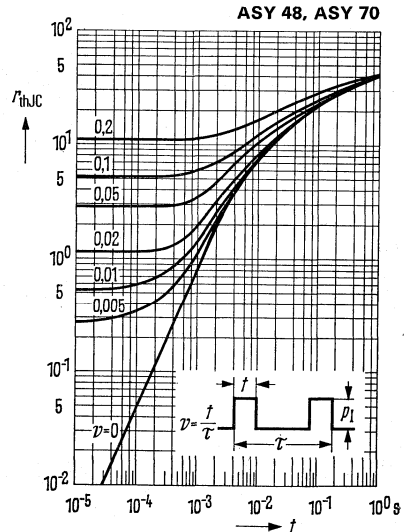

BC 107, BC 108, and BC 109 are epitaxial NPN silicon planar transistors in TO 18 metal case (18 A 3 DIN 41 876). The collector is electrically connected to the case.

The transistors are particularly suitable for use in AF input and driver stages.

Type	Ordering code
BC 107 ¹⁾	Q62702-C680
BC 107 A	Q60203-X107-A
BC 107 B	Q60203-X107-B
BC 108 ¹⁾	Q60203-X108
BC 108 A	Q60203-X108-A
BC 108 B	Q60203-X108-B
BC 108 C	Q60203-X108-C
BC 109 ¹⁾	Q60203-X109
BC 109 B	Q60203-X109-B
BC 109 C	Q60203-X109-C

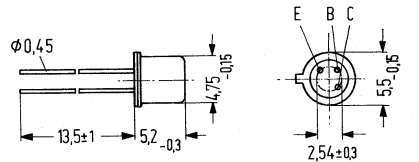

Approx. weight 0.3 g

Dimensions in mm

Maximum ratings		BC 107	BC 108	BC 109	
Collector-emitter voltage	V_{CES}	50	30	30	V
Collector-emitter voltage	V_{CEO}	45	20	20	V
Emitter-base voltage	V_{EBO}	6	5	5	V
Collector current	I_C	100	100	50	mA
Collector peak current	I_{CM}	200	200	—	mA
Base current	I_B	50	50	5	mA
Junction temperature	T_j	175	175	175	°C
Storage temperature range	T_{stg}	-55 to +175			°C
Total power dissipation	P_{tot}	300	300	300	mW

Thermal resistance

Junction to ambient air	R_{thJA}	≤ 500	≤ 500	≤ 500	K/W
Junction to case	R_{thJC}	≤ 200	≤ 200	≤ 200	K/W

1) If the order does not include any exact indication of the current amplification group desired, a transistor of a current amplification group just available from stock will be delivered.

Static characteristics ($T_{amb} = 25\text{ }^{\circ}\text{C}$). The transistors are grouped according to the DC current gain h_{FE} and marked by A, B, C. At $V_{CE} = 5\text{ V}$ and the collector currents indicated below the following static characteristics apply:

h_{FE} group	A	B	C
Type	BC 107 BC 108 –	BC 107 BC 108 BC 109	– BC 108 BC 109
I_C mA	h_{FE} I_C/I_B	h_{FE} I_C/I_B	h_{FE} I_C/I_B
0.01	90	150	270
2	170 (120 to 220)	290 (180 to 460)	500 (380 to 800)
100 ²⁾	120	200 ²⁾	400 ²⁾

BC 107 BC 108 BC 109					
I_C mA	V_{BE} V	I_C mA	I_B mA	$V_{CEsat}^{1)}$ V	$V_{BEsat}^{1)}$ V
0.1	0.55	10	0.5	0.07 (<0.2)	0.73 (<0.83)
2	0.62 (0.55 to 0.7)				
100 ²⁾	0.83 ²⁾	100 ²⁾	5	0.2 (<0.6) ²⁾	0.87 (<1.05) ²⁾

Static characteristics ($T_{amb} = 25\text{ }^{\circ}\text{C}$)	BC 107	BC 108	BC 109	
Collector cutoff current ($V_{CES} = 50\text{ V}$)	I_{CES} 0.2 (<15)	–	–	nA
Collector cutoff current ($V_{CES} = 30\text{ V}$)	I_{CES} –	0.2 (<15)	0.2 (<15)	nA
Collector cutoff current ($V_{CES} = 50\text{ V}$; $T_{amb} = 125\text{ }^{\circ}\text{C}$)	I_{CES} 0.2 (<4)	–	–	μA
Collector cutoff current ($V_{CES} = 30\text{ V}$; $T_{amb} = 125\text{ }^{\circ}\text{C}$)	I_{CES} –	0.2 (<4)	0.2 (<4)	μA
Emitter-base breakdown voltage ($I_{EBO} = 1\text{ }\mu\text{A}$)	$V_{(BR)EBO}$ >6	>5	>5	V
Collector-emitter break- down voltage ($I_{CEO} = 2\text{ mA}$)	$V_{(BR)CEO}$ >45	>20	>20	V

1) The transistor is overloaded to such an extent that the DC current gain decreases to $h_{FE} = 20$

2) These values do not apply to BC 109.

Dynamic characteristics ($T_{amb} = 25^{\circ}\text{C}$)		BC 107	BC 108	BC 109	
Transition frequency ($I_C = 0.5 \text{ mA}$; $V_{CE} = 3 \text{ V}$)	f_T	85	85	85	MHz
Transition frequency ($I_C = 10 \text{ mA}$; $V_{CE} = 5 \text{ V}$; $f = 100 \text{ MHz}$)	f_T	250 (>150)	250 (>150)	300 (<150)	MHz
Collector-base capacitance ($V_{CBO} = 10 \text{ V}$; $f = 1 \text{ MHz}$)	C_{CBO}	3.5 (<6)	3.5 (<6)	3.5 (<6)	pF
Emitter-base capacitance ($V_{EBO} = 0.5 \text{ V}$; $f = 1 \text{ MHz}$)	C_{EBO}	8	8	8	pF
Noise figure ($I_C = 0.2 \text{ mA}$; $V_{CE} = 5 \text{ V}$; $R_g = 2 \text{ k}\Omega$; $\Delta f = 30 \text{ Hz to } 15 \text{ kHz}$)	NF	–	–	<4	dB
Noise figure ($I_C = 0.2 \text{ mA}$; $V_{CE} = 5 \text{ V}$; $R_g = 2 \text{ k}\Omega$; $f = 1 \text{ kHz}$; $\Delta f = 200 \text{ Hz}$)	NF	2 (<10)	2 (<10)	<4	dB

Dynamic characteristics ($T_{amb} = 25^{\circ}\text{C}$)

$I_C = 2 \text{ mA}$; $V_{CE} = 5 \text{ V}$; $f = 1 \text{ kHz}$

h_{FE} group	A	B	C	
Type	BC 107 BC 108 –	BC 107 BC 108 BC 109	– BC 108 BC 109	
h_{11e}	2.7 (1.6 to 4.5)	4.5 (3.2 to 8.5)	8.7 (6 to 16)	k Ω
h_{12e}	1.5	2	3	10^{-4}
h_{21e}	220	330	600	–
h_{22e}	18 (<30)	30 (<60)	60 (<110)	μS

Total perm. power dissipation versus temperature

$P_{tot} = f(T); R_{th} = \text{parameter}$

BC 107, BC 108, BC 109

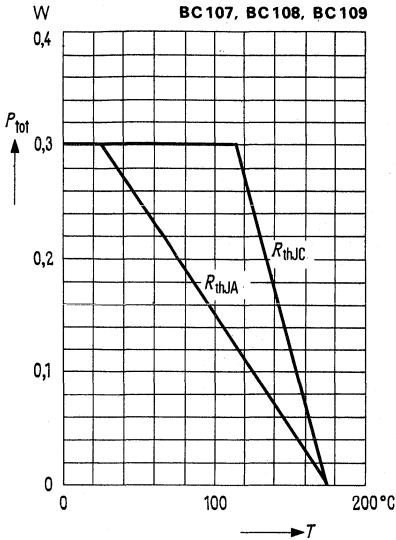

Permissible pulse load

$r_{thJC} = f(t); v = \text{parameter}$

BC 107, BC 108, BC 109

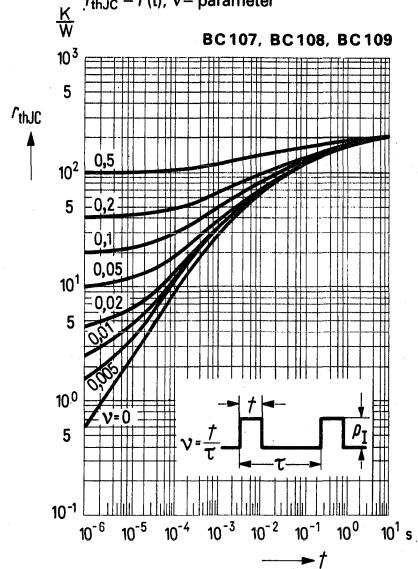

Collector current $I_C = f(V_{BE})$

$V_{CE} = 5 \text{ V}$ (common emitter configuration)

BC 107, BC 108, BC 109

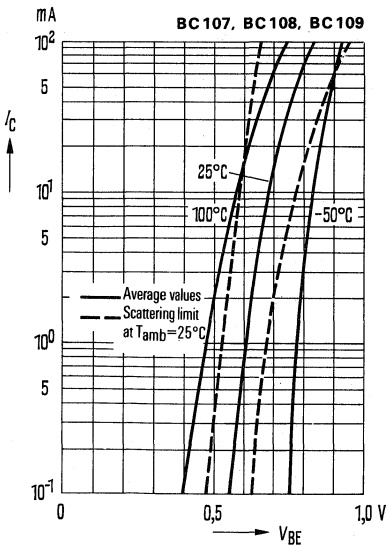

Input characteristic $I_B = f(V_{BE})$

$V_{CE} = 5 \text{ V}$ (common emitter configuration)

BC 107, BC 108, BC 109

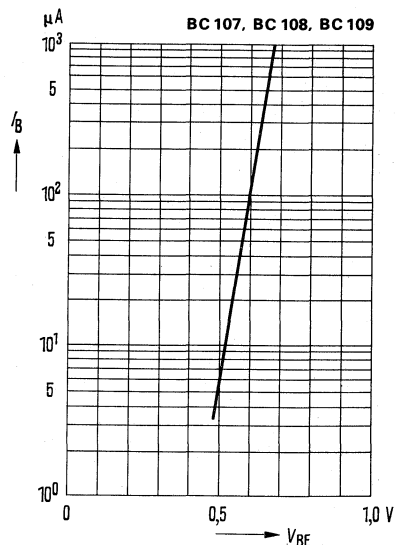

Output characteristics

$I_C = f(V_{CE}); I_B = \text{parameter}$
 (common emitter configuration)

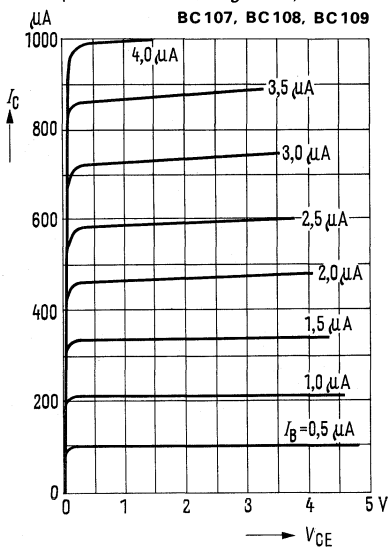

Output characteristics

$I_C = f(V_{CE}); V_{BE} = \text{parameter}$
 (common emitter configuration)

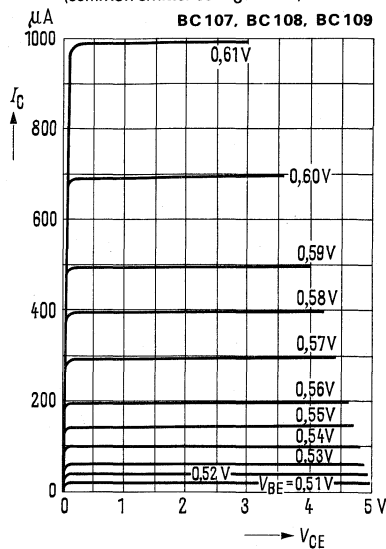

Collector-emitter saturation voltage

$V_{CEsat} = f(I_C); h_{FE} = 20; T_{amb} = \text{parameter}$
 (common emitter configuration)

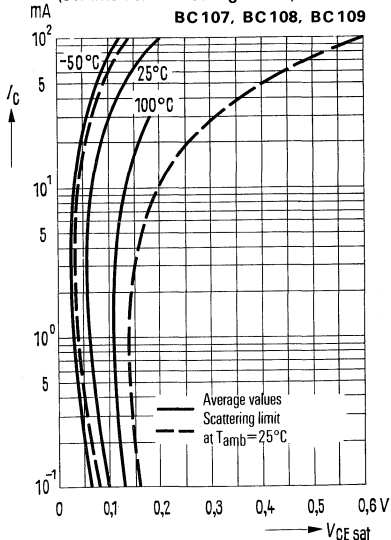

Base-emitter saturation voltage

$V_{BEsat} = f(I_C); h_{FE} = 20; T_{amb} = \text{parameter}$
 (common emitter configuration)

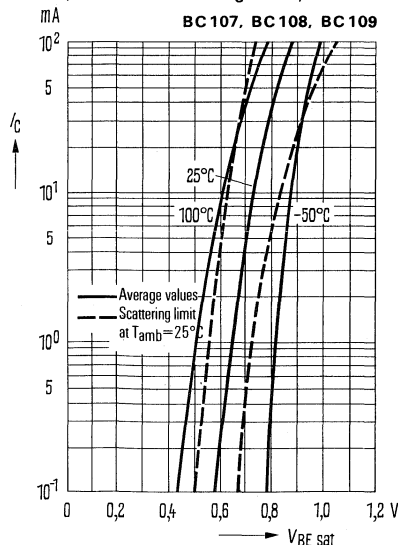

Collector cutoff current versus temperature $I_{CBO} = f(T_{amb})$
for maximum permissible breakdown voltage

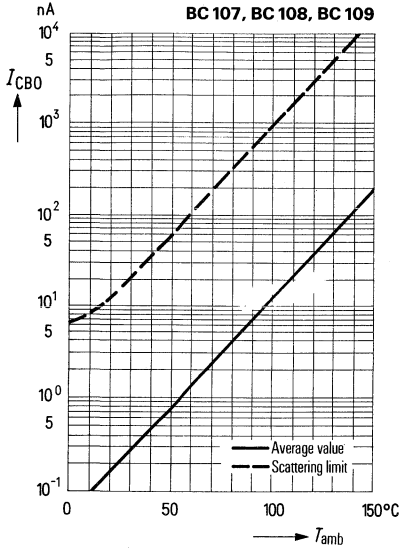

DC current gain $h_{FE} = f(I_C)$:
 $V_{CE} = 5\text{ V}$; $T_{amb} = \text{parameter}$
(common emitter configuration)

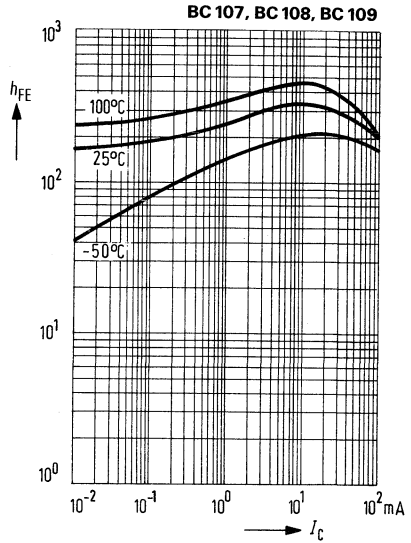

Transition frequency
 $f_T = f(I_C)$; $V_{CE} = \text{parameter}$

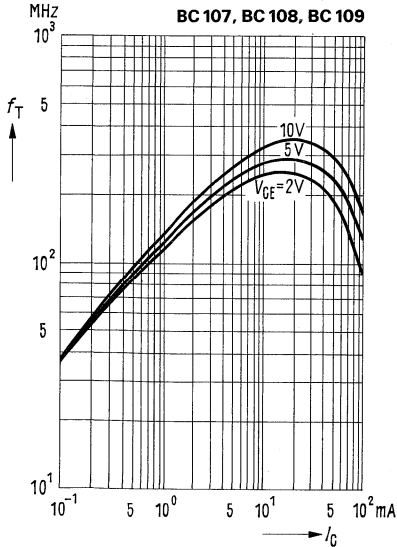

Collector-base capacitance

$C_{CBO} = f(V_{CBO})$

Emitter-base capacitance

$C_{EBO} = f(V_{EBO})$

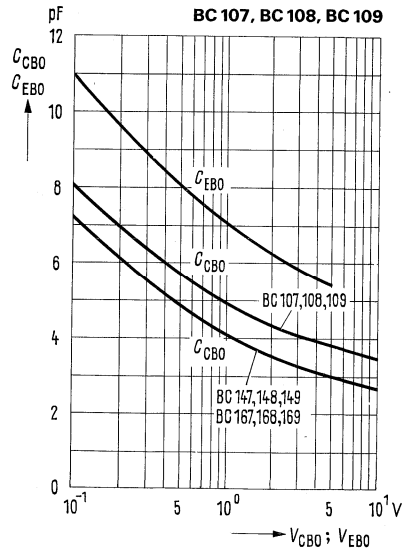

BC 107
BC 108
BC 109

h-parameter versus collector current

$$H_e = \frac{h_e(I_C)}{h_e(I_C = 2 \text{ mA})} = f(I_C); V_{CE} = 5 \text{ V}$$

BC 107, BC 108, BC 109

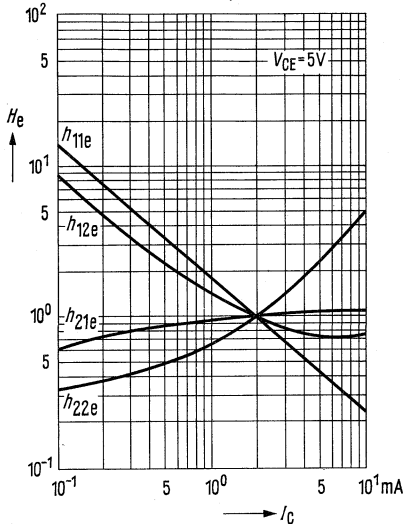

h-parameter versus collector-emitter voltage

$$H_e = \frac{h_e(V_{CE})}{h_e(V_{CE} = 5 \text{ V})} = f(V_{CE}); I_C = 2 \text{ mA}$$

BC 107, BC 108, BC 109

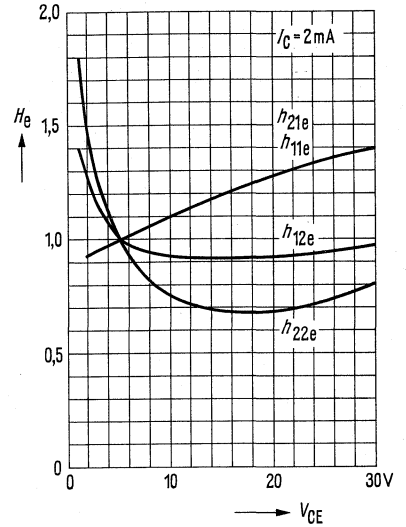

Noise figure $NF = f(I_C)$

$$V_{CE} = 5 \text{ V}; f = 120 \text{ Hz}; R_g = \text{parameter}$$

BC 109

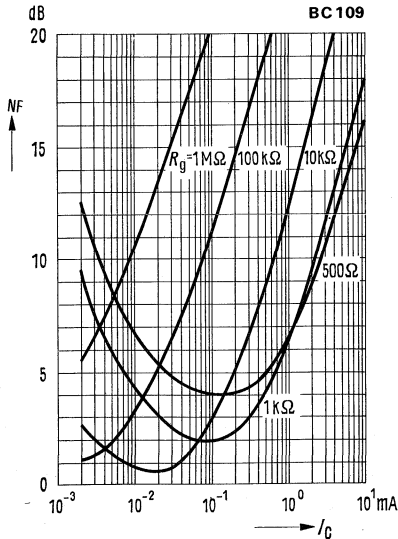

Noise figure $NF = f(I_C)$
 $V_{CE} = 5\text{ V}; f = 1\text{ kHz}; R_g = \text{parameter}$

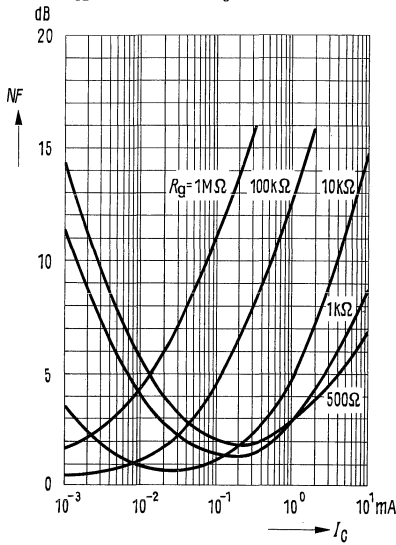

Noise figure $NF = f(I_C)$
 $V_{CE} = 5\text{ V}; f = 10\text{ kHz}; R_g = \text{parameter}$

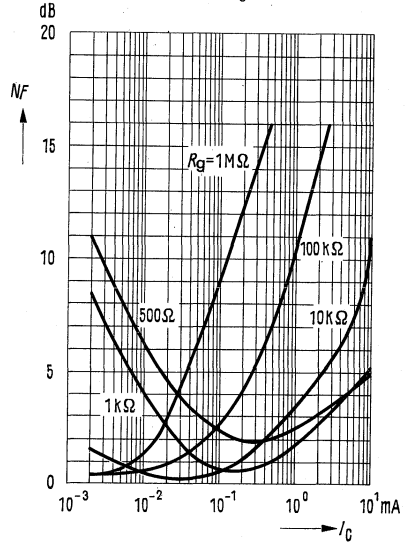

Noise figure $NF = f(V_{CE})$
 $I_C = 0.2\text{ mA}; R_g = 2\text{ k}\Omega; f = 1\text{ kHz}$
 $\Delta f = 200\text{ Hz}; T_{\text{amb}} = 25^\circ\text{C}$

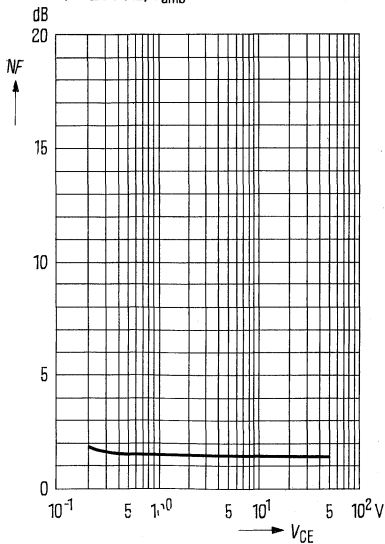

Noise figure $NF = f(f)$
 $V_{CE} = 5\text{ V}; I_C = 0.2\text{ mA}$
 $R_g = 2\text{ k}\Omega; T_{\text{amb}} = 25^\circ\text{C}$

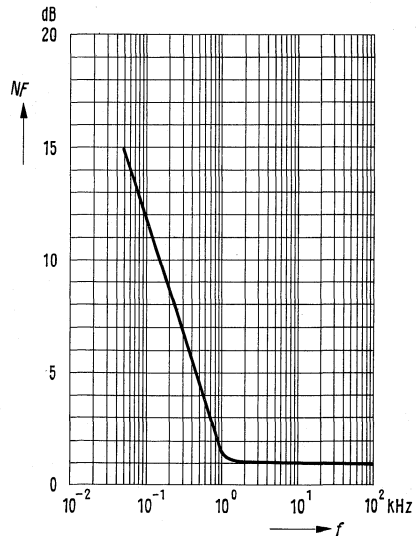

BC 121, BC 122, and BC 123 are miniature epitaxial NPN silicon planar transistors in U 32 plastic encapsulation. The types are marked by a color line on the case: BC 121 yellow, BC 122 white, BC 123 red. The transistors are particularly intended for use in low noise AF amplifier stages and as complementary transistors to BC 201, BC 202, and BC 203.

Type	Ordering code
BC 121 ¹⁾	Q60203-X121
BC 121 white	Q60203-X121-X9
BC 121 yellow	Q60203-X121-X4
BC 121 green	Q60203-X121-S6
BC 121 blue	Q60203-X121-X6
BC 122 ¹⁾	Q60203-X122
BC 122 white	Q60203-X122-X9
BC 122 yellow	Q60203-X122-X4
BC 122 green	Q60203-X122-X10
BC 122 blue	Q60203-X122-X6
BC 123 ¹⁾	Q60203-X123
BC 123 white	Q60203-X123-X9
BC 123 yellow	Q60203-X123-X4
BC 123 green	Q60203-X123-X5

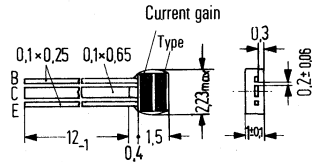

Approx. weight 20 mg

Dimensions in mm

Maximum ratings		BC 121	BC 122	BC 123	
Collector-emitter voltage	V_{CEO}	5	20	30	V
Collector-base voltage	V_{CBO}	5	30	45	V
Emitter-base voltage	V_{EBO}	5	5	5	V
Collector current	I_C	75	75	75	mA
Emitter current	I_E	85	85	85	mA
Base current	I_B	10	10	10	mA
Junction temperature	T_j	150	150	150	°C
Storage temperature range	T_{stg}	-55 to +125	-55 to +125	-55 to +125	°C
Total power dissipation					
Lead length $L = 2$ mm; see diagram ²⁾ $R_{th} = f(L)$	P_{tot}	250	250	250	mW
Thermal resistance					
see diagram ²⁾ $R_{th} = f(L)$	R_{thJA}	≤ 1000	≤ 1000	≤ 1000	K/W

1) If the order does not include any exact indication of the current amplification group desired, a transistor of a current amplification group just available from stock will be delivered.

2) (page 146)

Static characteristics ($T_{amb} = 25^{\circ}\text{C}$)

The transistors are grouped according to the small signal current gain h_{fe} and marked by a color line. At a voltage of $V_{CE} = 2\text{ V}$ and the collector currents listed below, the following static characteristics apply:

h_{fe} groups	white	yellow	green	blue	
Type	BC 121 BC 122 BC 123	BC 121 BC 122 BC 123	BC 121 BC 122 BC 123	BC 121 BC 122 -	BC 121 BC 122 BC 123
I_C mA	h_{FE} I_C/I_B	h_{FE} I_C/I_B	h_{FE} I_C/I_B	h_{FE} I_C/I_B	V_{BE} mV
0.01	63	110	180	330	530
0.25	100	175	290	520	560 (500-630)
10	125	220	320	620	610

Static characteristics ($T_{amb} = 25^{\circ}\text{C}$)

Saturation voltages

($I_C = 10\text{ mA}$; $I_B = 0.5\text{ mA}$)

($I_C = 50\text{ mA}$; $I_B = 2.5\text{ mA}$)

	V_{CEsat}	V_{BEsat}	
	0.07 (<0.2)	0.73 (<0.83)	V
	0.13 (<0.4)	0.82 (>0.95)	V

	BC 121	BC 122	BC 123	
Collector cutoff current ($V_{CBO} = 25\text{ V}$)				
I_{CBO}	-	-	<10	nA
Collector cutoff current ($V_{CBO} = 15\text{ V}$)				
I_{CBO}	-	<10	-	nA
Collector cutoff current ($V_{CBO} = 2\text{ V}$)				
I_{CBO}	<10	-	-	nA
Collector-emitter breakdown voltage ($I_{CEO} = 100\text{ }\mu\text{A}$)				
$V_{(BR)CEO}$	>5	>20	>30	V
Collector-base breakdown voltage ($I_{CBO} = 100\text{ }\mu\text{A}$)				
$V_{(BR)CBO}$	>5	>30	>45	V
Emitter-base breakdown voltage ($I_{EBO} = 100\text{ }\mu\text{A}$)				
$V_{(BR)EBO}$	>5	>5	>5	V

Dynamic characteristics ($T_{amb} = 25^{\circ}\text{C}$)		BC 121	BC 122	BC 123	
Transition frequency ($I_C = 250 \mu\text{A}$; $V_{CE} = 0.5 \text{ V}$)	f_T	50	50	50	MHz
Transition frequency ($I_C = 10 \text{ mA}$; $V_{CE} = 0.5 \text{ V}$)	f_T	250	250	250	MHz
Collector-base capacitance ($V_{CBO} = 2 \text{ V}$; $f = 1 \text{ MHz}$)	C_{CBO}	4.4 (<11)	–	–	pF
Collector-base capacitance ($V_{CBO} = 10 \text{ V}$; $f = 1 \text{ MHz}$)	C_{CBO}	–	3.5 (<7)	3.5 (<7)	pF
Noise figure ($I_C = 200 \mu\text{A}$; $V_{CE} = 0.5 \text{ V}$; $f = 1 \text{ kHz}$; $\Delta f = 200 \text{ Hz}$; $R_g = 2 \text{ k}\Omega$)	NF	2.5 (<5)	2.5 (<5)	2.5 (<5)	dB

Current gain groups

The transistors BC 121, BC 122, BC 123 are grouped according to the small signal current gain h_{fe} and are marked by a color line.

Operating point: $V_{CE} = 0.5 \text{ V}$; $I_C = 250 \mu\text{A}$; $f = 1 \text{ kHz}$

Color line	white	yellow	green	blue
Type	BC 121 BC 122 BC 123	BC 121 BC 122 BC 123	BC 121 BC 122 BC 123	BC 121 BC 122 –
Small signal current gain h_{fe}	75 to 150	125 to 260	240 to 500	450 to 900

Total perm. power dissipation versus temperature $P_{tot} = f(T_{amb})$;
 lead length "L"-parameter

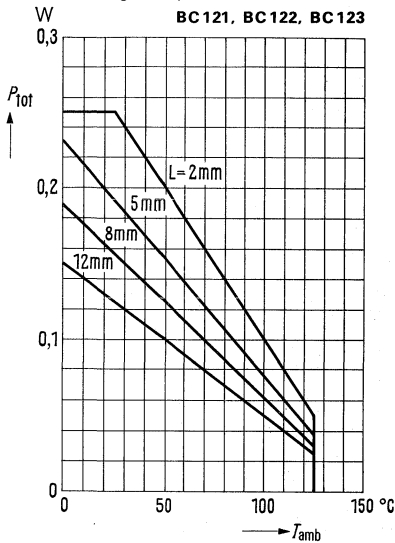

Thermal resistance
 $R_{th} = f(\text{lead length "L"})$

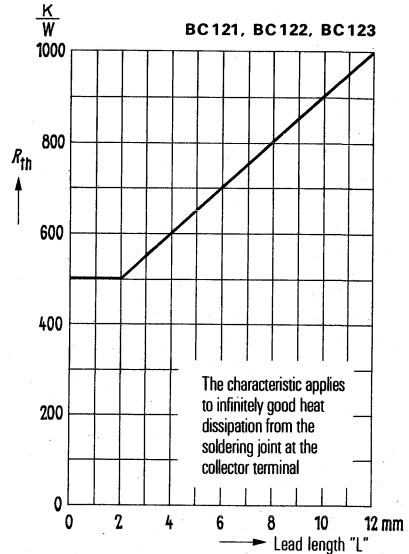

DC current gain $h_{FE} = f(I_C)$
 $V_{CE} = 2 V$, T_{amb} = parameter
 (common emitter configuration)
 BC 121 yellow, BC 122 yellow,
 BC 123 yellow

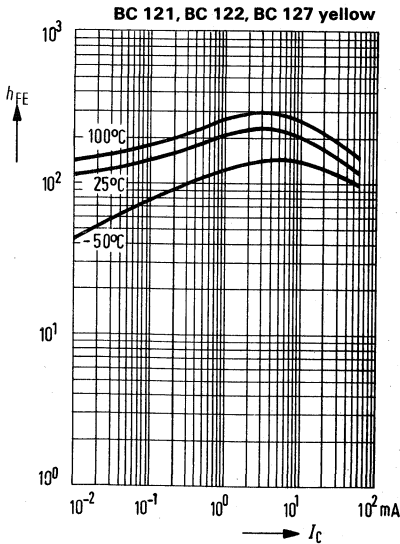

Collector current $I_C = f(V_{BE})$
 T_{amb} = parameter; $V_{CE} = 2 V$
 (common emitter configuration)

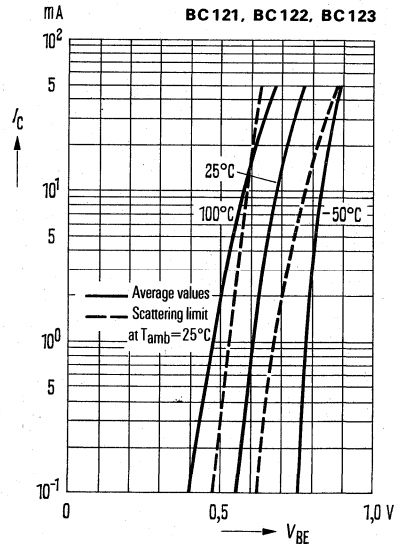

Output characteristics $I_C = f(V_{CE})$:
 $I_B = \text{parameter}$, $T_{\text{amb}} = 25^\circ\text{C}$
 (common emitter configuration)

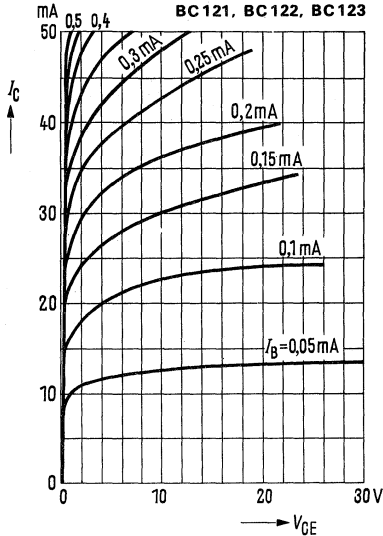

Output characteristics $I_C = f(V_{CE})$:
 $I_B = \text{parameter}$
 (common emitter configuration)

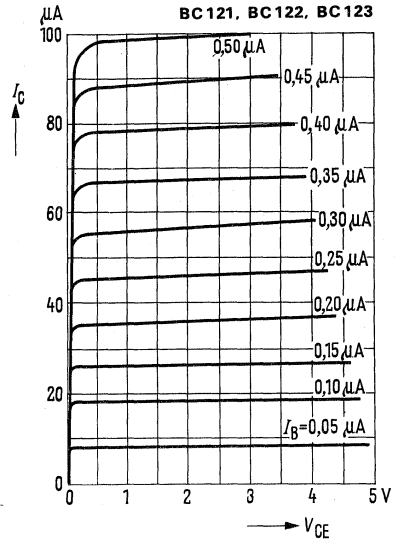

Collector-emitter saturation voltage
 $V_{CE\text{sat}} = f(I_C)$
 $h_{FE} = 20$; $T_{\text{amb}} = \text{parameter}$
 (common emitter configuration)

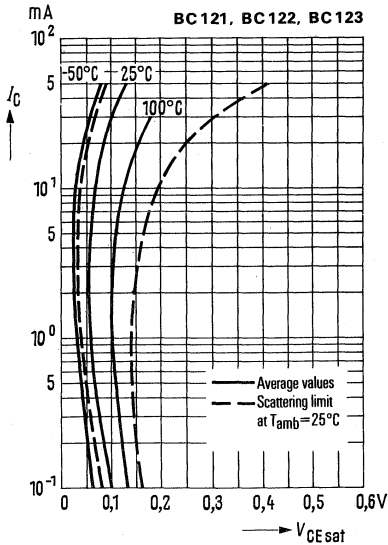

Base-emitter saturation voltage
 $V_{BE\text{sat}} = f(I_C)$
 $h_{FE} = 20$; $T_{\text{amb}} = \text{parameter}$
 (common emitter configuration)

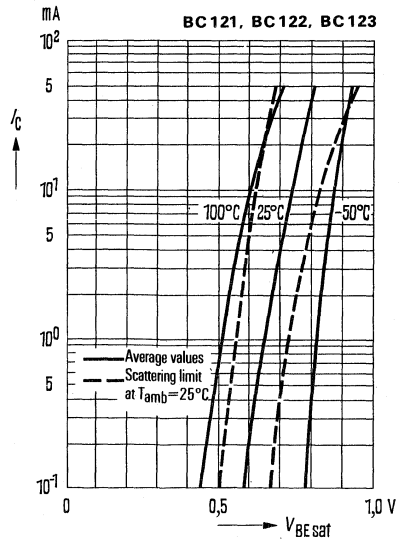

Collector cutoff current versus temperature
 $I_{CBO} = f(T_{amb})$

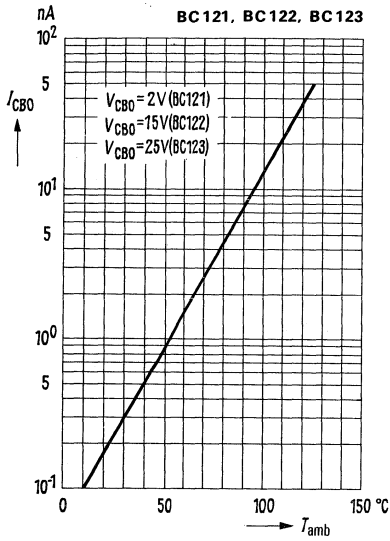

Transition frequency $f_T = f(I_C)$;
 $V_{CE} = 0.5; 2.0V$

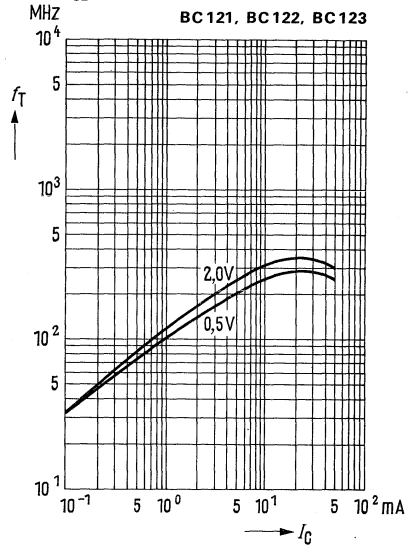

Emitter-base capacitance $C_{EBO} = f(V_{EBO})$
Collector-base capacitance $C_{CBO} = f(V_{CBO})$

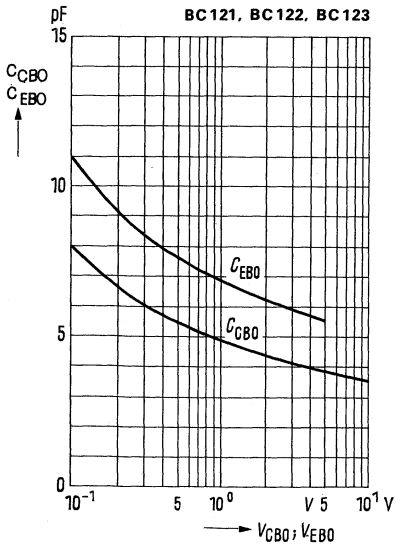

Input characteristic $I_B = f(V_{BE})$
 $V_{CE} = 2V$
(common emitter configuration)

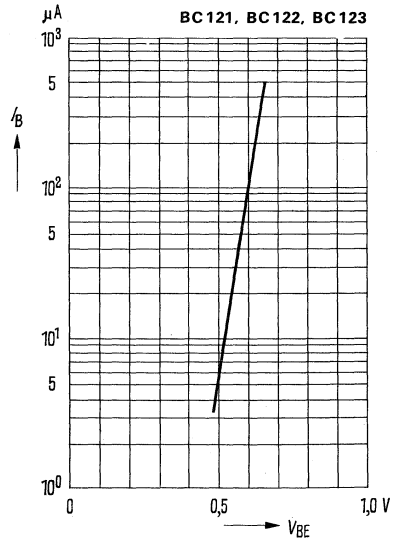

BC 121
BC 122
BC 123

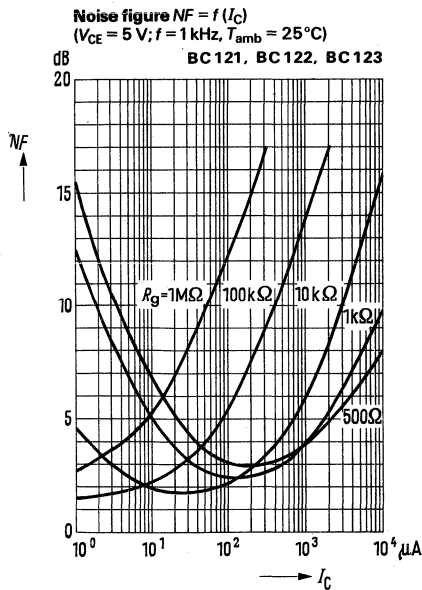
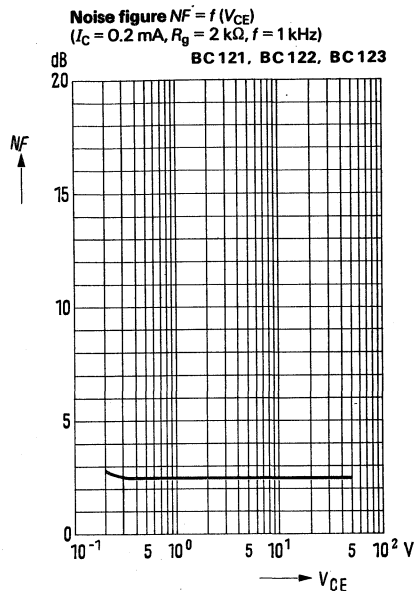
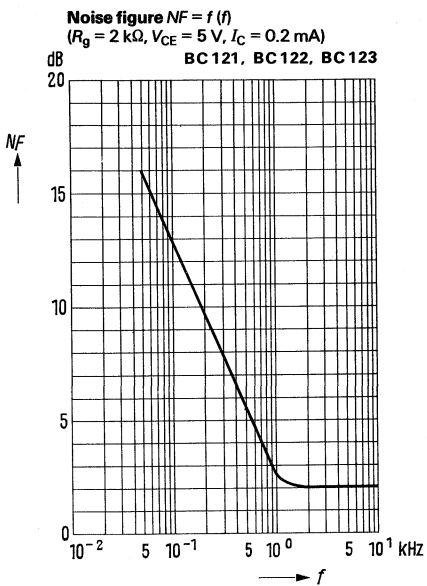

BC 140 and BC 141 are epitaxial NPN silicon transistors in TO 39 case (5 C 3 DIN 41873). The collector is electrically connected to the case. The transistors are intended for use in AF amplifiers and as complementary transistors to BC 160 and BC 161, as well as for AF switching applications up to 1 A. The transistors BC 140 and BC 141 are available upon request as matched pairs.

Type	Ordering code
BC 140 ¹⁾	Q60203-X140
BC 140-6	Q60203-X140-V6
BC 140-10	Q60203-X140-V10
BC 140-16	Q60203-X140-V16
BC 140 paired	Q60203-X140-P
BC 140/BC 160 paired	Q62702-C228-S2
BC 141 ¹⁾	Q62702-C719
BC 141-6	Q62702-C234
BC 141-10	Q62702-C235
BC 141-16	Q62702-C236
BC 141 paired	Q62702-C209
BC 141/BC 161 paired	Q62702-C230-S2

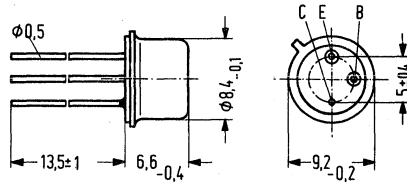

Approx. weight 1.5 g Dimensions in mm

Maximum ratings		BC 140	BC 141	
Collector-base voltage	V_{CBO}	80	100	V
Collector-emitter voltage	V_{CEO}	40	60	V
Emitter-base voltage	V_{EBO}	7	7	V
Collector current	I_C	1	1	A
Base current	I_B	0.1	0.1	A
Junction temperature	T_j	175	175	°C
Storage temperature range	T_{stg}	-55 to +175	-55 to +175	°C
Total power dissipation	P_{tot}	3.7	3.7	W

Thermal resistance

Junction to ambient air	R_{thJA}	≤ 200	≤ 200	K/W
Junction to case	R_{thJC}	≤ 35	≤ 35	K/W

Static characteristics ($T_{amb} = 25^\circ\text{C}$)

The transistors BC 140 and BC 141 are grouped at $I_C = 100\text{ mA}$ and $V_{CE} = 1\text{ V}$ according to the DC current gain h_{FE} and are marked by numerals of the DIN standard series. For the operating points quoted below, the following values apply:

Type	BC 140, BC 141			
h_{FE} -group	6	10	16	
I_C mA	h_{FE} I_C/I_B	h_{FE} I_C/I_B	h_{FE} I_C/I_B	V_{BE} V
0.1	28	40	90	-
100	63 (40 to 100)	100 (63 to 160)	160 (100 to 250)	-
1000	15	20	30	1.2 (<1.8)

1) If the order does not include any exact indication of the current amplification group desired, a transistor of a current amplification group just available from stock will be delivered.

Static characteristics ($T_{amb} = 25^{\circ}\text{C}$)		BC 140	BC 141	
Collector cutoff current ($V_{CES} = 60\text{ V}$)	I_{CES}	10 (<100)	10 (<100)	nA
Collector cutoff current ($V_{CES} = 60\text{ V}; T_{amb} = 150^{\circ}\text{C}$)	I_{CES}	10 (<100)	10 (<100)	μA
Collector-emitter breakdown voltage ($I_{CEO} = 30\text{ mA}$; pulse width = 200 μsec ; duty cycle 1%)	$V_{(BR)CEO}$	>40	>60	V
Collector-emitter breakdown voltage ($I_{CES} = 100\text{ }\mu\text{A}$)	$V_{(BR)CES}$	>80	>100	V
Emitter-base breakdown voltage ($I_{EBO} = 100\text{ }\mu\text{A}$)	$V_{(BR)EBO}$	>7	>7	V
Collector emitter saturation voltage ($I_C = 0.5\text{ A}; I_B = 25\text{ mA}$)	$V_{CEsat}^1)$	0.6 (<1.0)	0.6 (<1.0)	V
Conditions for matching pairs: ($I_C = 100\text{ mA}; V_{CE} = 1\text{ V}$)	$\frac{h_{FE1}}{h_{FE2}}$	≤ 1.25	≤ 1.25	

Dynamic characteristics ($T_{amb} = 25^{\circ}\text{C}$)				
Transition frequency ($I_C = 50\text{ mA}$; $V_{CE} = 10\text{ V}; f = 20\text{ MHz}$)	f_T	>50	>50	MHz
Collector-base capacitance ($V_{CB} = 10\text{ V}; f = 1\text{ MHz}$)	C_{CBO}	<25	<25	pF
Emitter-base capacitance ($V_{EB} = 0.5\text{ V}; f = 1\text{ MHz}$)	C_{EBO}	<80	<80	pF

Test circuit

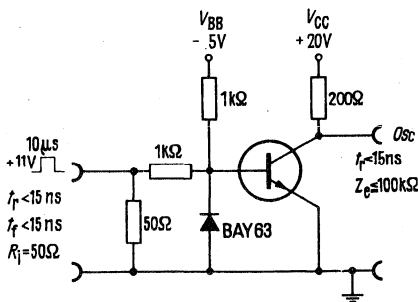

Switching times for transistors

BC 140, BC 141:

($I_C = 100\text{ mA}; I_{B1}$ approx. $-I_{B2}$ approx. 5 mA)

t_{on}	<250	ns
t_{off}	<850	ns

1) The transistor is overloaded to such an extent that the DC current gain decreases to $h_{FE} = 20$.

Total perm. power dissipation versus temperature
 $P_{tot} = f(T), R_{th} = \text{parameter}$

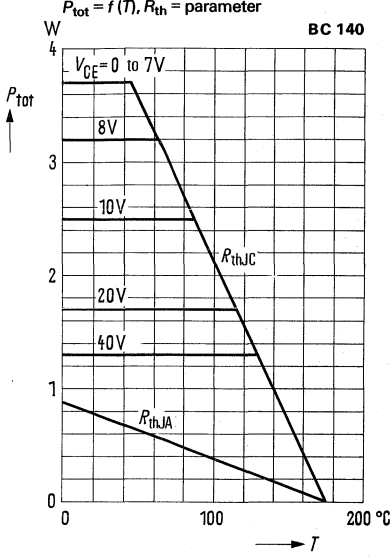

Total perm. power dissipation versus temperature
 $P_{tot} = f(T), R_{th} = \text{parameter}$

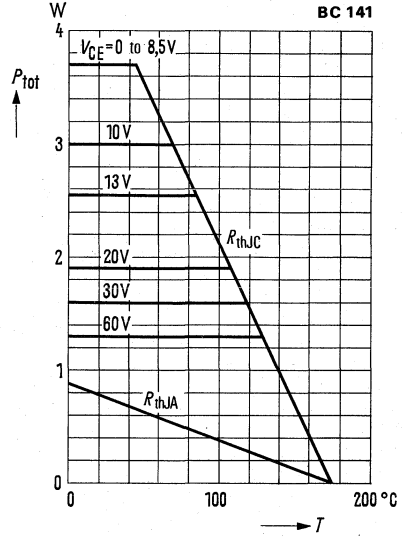

Permissible pulse load
 $r_{thJC} = f(f); v = \text{parameter}$

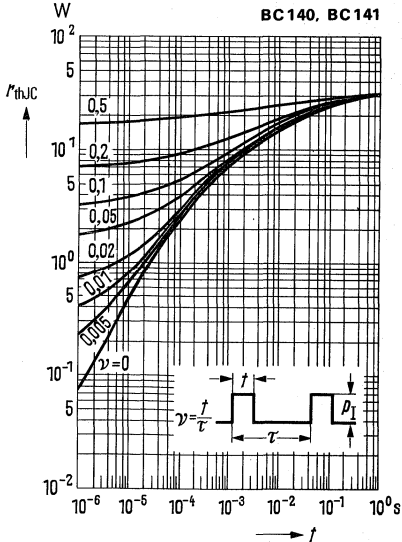

Transition frequency $f_T = f(I_C)$
 $V_{CE} = 10\text{V}$

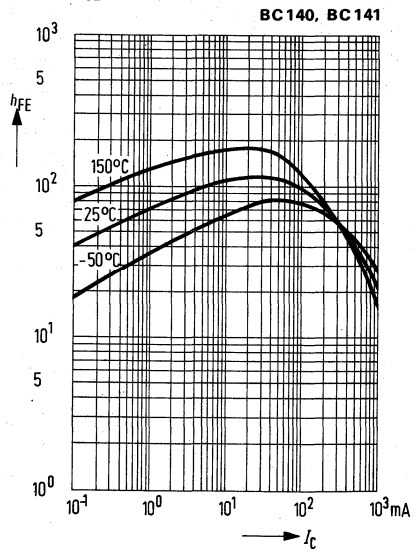

Collector-emitter saturation voltage

$V_{CE sat} = f(I_C)$
 $h_{FE} = 10; T_{amb} = \text{parameter}$
(common emitter configuration)

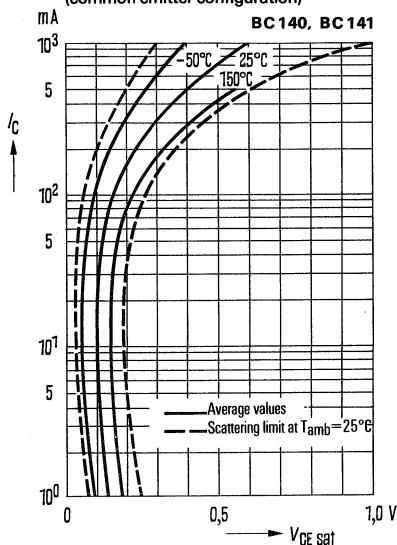

Base-emitter saturation voltage

$V_{BE sat} = f(I_C)$
 $h_{FE} = 10; T_{amb} = \text{parameter}$
(common emitter configuration)

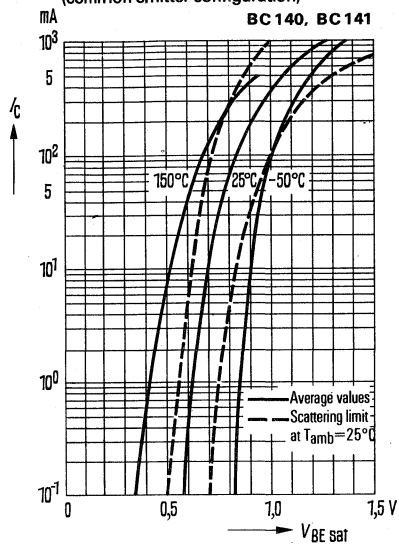

Collector cutoff current versus temperature

$I_{CBO} = f(T_{amb}); V_{CBO} = 60\text{ V}$

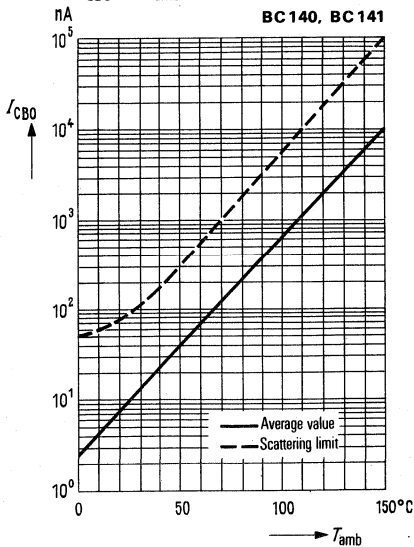

Transition frequency $f_T = f(I_C)$
($V_{CE} = 10\text{ V}$)

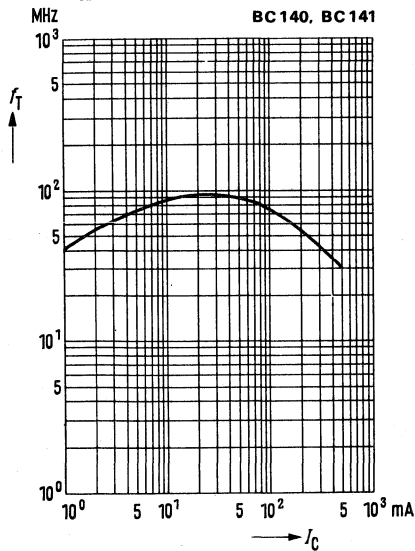

BC 160 and BC 161 are epitaxial PNP silicon transistors in TO 39 case (5 C 3 DIN 41873). The collector is electrically connected to the case. The transistors are intended for use as complementary transistors to BC 140 and BC 141 and are available upon request as matched pairs.

Type	Ordering code
BC 160 ¹⁾	Q62702-C228
BC 160-6	Q62702-C228-V6
BC 160-10	Q62702-C228-V10
BC 160-16	Q62702-C228-V16
BC 160 paired	Q62702-C228-P
BC 160/BC 140 paired	Q62702-C228-S2
BC 161 ¹⁾	Q62702-C252
BC 161-6	Q62702-C230
BC 161-10	Q62702-C231
BC 161-16	Q62702-C239
BC 161 paired	Q62702-C230-P
BC 161/BC 141 paired	Q62702-C230-S2

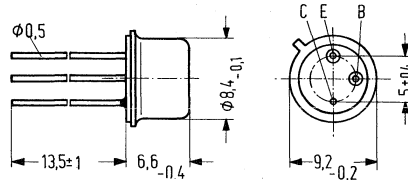

Approx. weight 1.5 g Dimensions in mm

Maximum ratings		BC 160	BC 161	
Collector-base voltage	$-V_{CBO}$	40	60	V
Collector-emitter voltage	$-V_{CEO}$	40	60	V
Emitter-base voltage	$-V_{EBO}$	5	5	V
Collector current	$-I_C$	1	1	A
Base current	$-I_B$	0.1	0.1	A
Junction temperature	T_j	175	175	°C
Storage temperature range	T_{stg}	-55 to +175	-55 to +175	°C
Total power dissipation	P_{tot}	3.7	3.7	W

Thermal resistance

Junction to ambient air	R_{thJA}	≤ 200	≤ 200	K/W
Junction to case	R_{thJC}	≤ 35	≤ 35	K/W

Static characteristics ($T_{amb} = 25\text{ °C}$)

The transistors BC 160 and BC 161 are grouped at $-I_C = 100\text{ mA}$ and $-V_{CE} = 1\text{ V}$ according to the DC current gain h_{FE} , and are marked by numerals of the DIN standard series. For the operating points quoted below, the following values apply:

Type	BC 160, BC 161			
h_{FE} group	6	10	16	
$-I_C$ mA	h_{FE} I_C/I_B	h_{FE} I_C/I_B	h_{FE} I_C/I_B	$-V_{BE}$ V
0.1	46	80	120	-
100	63 (40 to 100)	100 (63 to 160)	160 (100 to 250)	-
1000	15	20	30	1.0 (<1.7)

1) If the order does not include any exact indication of the current amplification group desired, a transistor of a current amplification group just available from stock will be delivered.

Static characteristics ($T_{amb} = 25^{\circ}\text{C}$)

Collector cutoff current

($-V_{CES} = 40\text{ V}$ or 60 V)

Collector cutoff current

($-V_{CES} = 40\text{ V}$ or 60 V ;

$T_{amb} = 150^{\circ}\text{C}$)

Collector-emitter breakdown

voltage ($-I_{CEO} = 50\text{ mA}$

pulse width = $200\text{ }\mu\text{s}$;

duty cycle 1%)

Collector-emitter breakdown

voltage ($-I_{CES} = 100\text{ }\mu\text{A}$)

Emitter-base breakdown

voltage ($-I_{EBO} = 100\text{ }\mu\text{A}$)

Collector-emitter saturation

voltage ($-I_C = 0.5\text{ A}$; $-I_B = 25\text{ mA}$)

Conditions for matching pairs:

($-I_C = 100\text{ mA}$; $-V_{CE} = 1\text{ V}$)

	BC 160	BC 161	
$-I_{CES}$	10 (<100)	10 (<100)	nA
$-I_{CES}$	10 (<100)	10 (<100)	μA
$-V_{(BR)CEO}$	>40	>60	V
$-V_{(BR)CES}$	>40	>60	V
$-V_{(BR)EBO}$	>5	>5	V
$-V_{CEsat}^{1)}$	0.6 (<1.0)	0.6 (<1.0)	V
$\frac{h_{FE1}}{h_{FE2}}$	≤ 1.25	≤ 1.25	

Dynamic characteristics ($T_{amb} = 25^{\circ}\text{C}$)

Transition frequency ($-I_C = 50\text{ mA}$;

$-V_{CE} = 10\text{ V}$; $f = 20\text{ MHz}$)

Collector-base capacitance

($-V_{CB} = 10\text{ V}$; $f = 1\text{ MHz}$)

Emitter-base capacitance

($-V_{EB} = 0.5\text{ V}$; $f = 1\text{ MHz}$)

f_T	>50	>50	MHz
C_{CBO}	<30	<30	pF
C_{EBO}	<180	<180	pf

Test circuit:

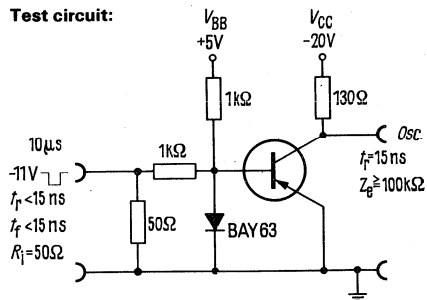

Switching times for transistors
BC 160, BC 161:

($-I_C = 100\text{ mA}$; I_{B1} approx. $-I_{B2}$ approx. 5 mA)

t_{on}	<500	ns
t_{off}	<650	ns

1) The transistor is overloaded to such an extent that the DC current gain decreases to $h_{FE} = 20$

Total power dissipation versus temperature
 $P_{tot} = f(T); R_{th} = \text{parameter}$

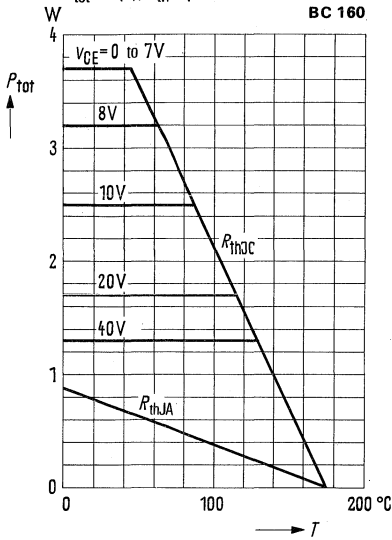

Total power dissipation versus temperature
 $P_{tot} = f(T); R_{th} = \text{parameter}$

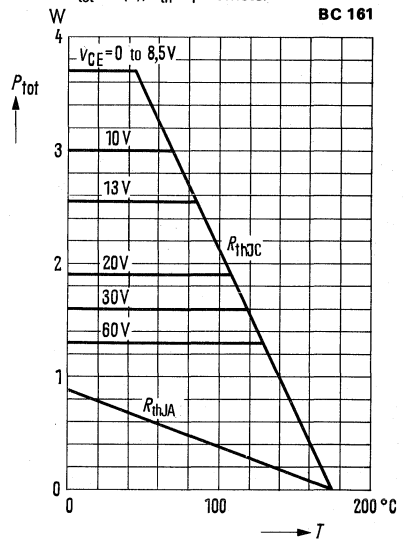

Permissible pulse load
 $i_{thJC} = f(t); v = \text{parameter}$

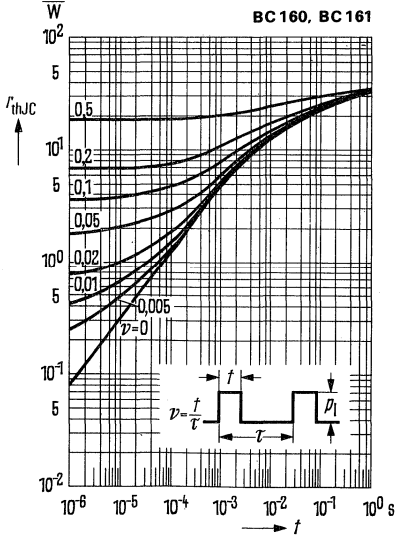

DC current gain $h_{FE} = f(I_C)$
 $-V_{CE} = 1V; T_{amb} = \text{parameter}$
(common emitter configuration)

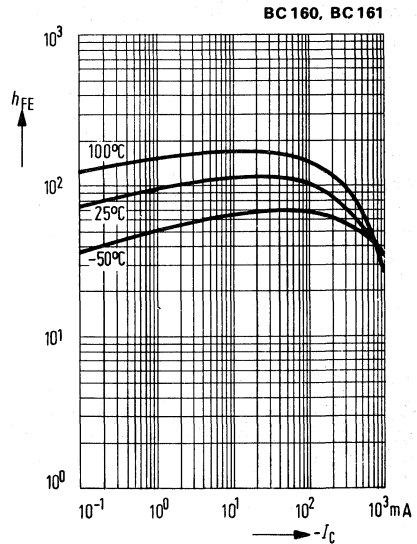

Collector-emitter saturation voltage

$V_{CEsat} = f(I_C)$
 $h_{FE} = 10; T_{amb} = \text{parameter}$
(common emitter configuration)

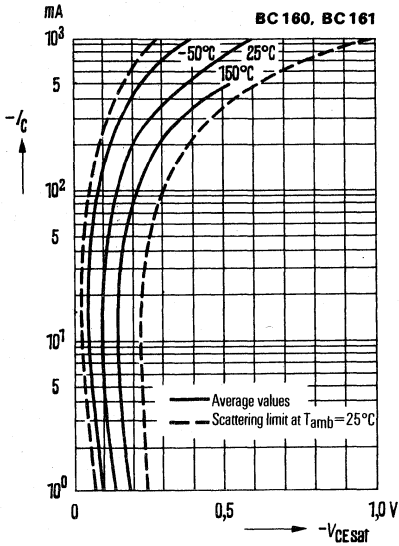

Emitter-base saturation voltage

$V_{BEsat} = f(I_C)$
 $h_{FE} = 10; T_{amb} = \text{parameter}$
(common emitter configuration)

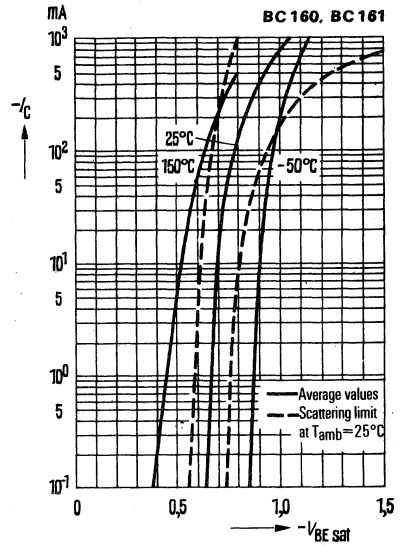

Collector cutoff current versus temperature

$I_{CBO} = f(T_{amb}); -V_{CBO} = 60 \text{ V}$

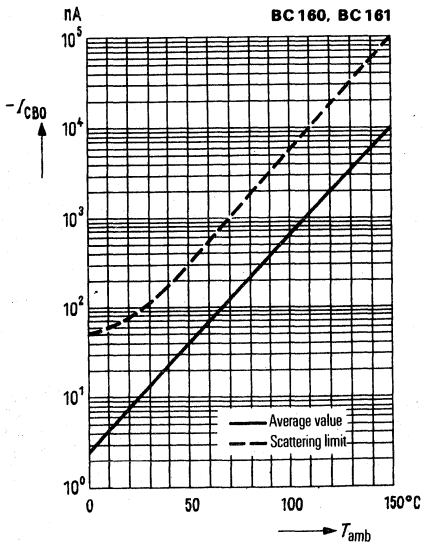

Transition frequency $f_T = f(I_C)$
($-V_{CE} = 10 \text{ V}$)

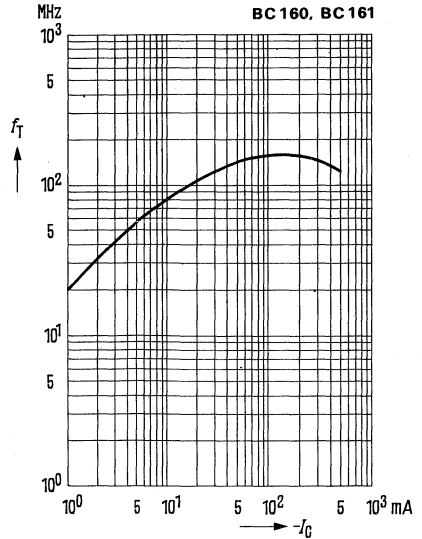

BC 167, BC 168, and BC 169 are epitaxial NPN silicon planar transistors in TO 92 plastic package (10 A 3 DIN 41868). The transistors are particularly suitable for use in AF input and driver stages and as complementary transistors to BC 257, BC 258 and BC 259. BC 169 is particularly intended for use in low-noise input stages.

Type	Ordering code
BC 167 ¹⁾	Q62702-C706
BC 167 A	Q62702-C74
BC 167 B	Q62702-C75
BC 168 ¹⁾	Q62702-C707
BC 168 A	Q62702-C76
BC 168 B	Q62702-C77
BC 168 C	Q62702-C78
BC 169 ¹⁾	Q62702-C708
BC 169 B	Q62702-C79
BC 169 C	Q62702-C80

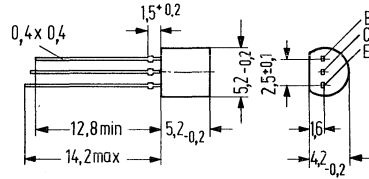

Approx. weight 0.25 g Dimensions in mm

For mounting instructions and hole diameters see >Introduction<

Maximum ratings

		BC 167	BC 168	BC 169	
Collector-emitter voltage	V_{CES}	50	30	30	V
Collector-emitter voltage	V_{CEO}	45	20	20	V
Emitter-base voltage	V_{EBO}	6	5	5	V
Collector current	I_C	100	100	50	mA
Collector peak current	I_{CM}	200	200	—	mA
Base current	I_B	50	50	5	mA
Junction temperature	T_j	150	150	150	°C
Storage temperature range	T_{stg}		-55 to +150		°C
Total power dissipation	P_{tot}	300	300	300	mW

Thermal resistance

Junction to ambient air	R_{thJA}	≤420	≤420	≤420	K/W
-------------------------	------------	------	------	------	-----

1) If the order does not include any exact indication of the current amplification group desired, a transistor of a current amplification group just available from stock will be delivered.

Static characteristics ($T_{amb} = 25^{\circ}\text{C}$)

The transistors are grouped according to the DC current gain h_{FE} , and are marked by A, B, C. At $V_{CE} = 5\text{ V}$ and the collector currents indicated below the following static characteristics apply:

h_{FE} group	A	B	C
Type	BC 167 BC 168 –	BC 167 BC 168 BC 169	– BC 168 BC 169
I_C mA	h_{FE} I_C/I_B	h_{FE} I_C/I_B	h_{FE} I_C/I_B
0.01	90	150	270
2	170 (120 to 220)	290 (180 to 460)	500 (380 to 800)
100 ²⁾	120	200 ²⁾	400 ²⁾

Type | **BC 167, BC 168, BC 169**

I_C mA	V_{BE} V	I_C mA	I_B mA	$V_{CEsat}^{1)}$ V	$V_{BEsat}^{1)}$ V
0.1	0.55	10	0.5	0.07 (<0.2)	0.73 (<0.83)
2	0.62 (0.55 to 0.7)				
100 ²⁾	0.83 ²⁾	100 ²⁾	5	0.2 (<0.6) ²⁾	0.87 (<1.05) ²⁾

Static characteristics ($T_{amb} = 25^{\circ}\text{C}$)

		BC 167	BC 168	BC 169	
Collector cutoff current ($V_{CES} = 50\text{ V}$)	I_{CES}	0.2 (<15)	–	–	nA
Collector cutoff current ($V_{CES} = 30\text{ V}$)	I_{CES}	–	0.2 (<15)	0.2 (<15)	nA
Collector cutoff current ($V_{CES} = 50\text{ V}$; $T_{amb} = 125^{\circ}\text{C}$)	I_{CES}	0.2 (<4)	–	–	μA
Collector cutoff current ($V_{CES} = 30\text{ V}$; $T_{amb} = 125^{\circ}\text{C}$)	I_{CES}	–	0.2 (<4)	0.2 (<4)	μA
Emitter-base breakdown voltage ($I_{EBO} = 1\ \mu\text{A}$)	$V_{(BR)EBO}$	>6	>5	>5	V
Collector-emitter breakdown voltage ($I_{CEO} = 2\text{ mA}$)	$V_{(BR)CEO}$	>45	>20	>20	V

1) The transistor is overloaded to such an extent that the DC current gain decreases to $h_{FE} = 20$

2) These values do not apply to BC 169.

Dynamic characteristics ($T_{amb} = 25^{\circ}\text{C}$)

		BC 167	BC 168	BC 169	
Transition frequency ($I_C = 0.5 \text{ mA}$; $V_{CE} = 3 \text{ V}$)	f_T	85	85	85	MHz
Transition frequency ($I_C = 10 \text{ mA}$; $V_{CE} = 5 \text{ V}$; $f = 100 \text{ MHz}$)	f_T	250 (> 150)	250 (> 150)	300 (> 150)	MHz
Collector-base capacitance ($V_{CBO} = 10 \text{ V}$; $f = 1 \text{ MHz}$)	C_{CBO}	3.5 (<6)	3.5 (<6)	3.5 (<6)	pF
Emitter-base capacitance ($V_{EBO} = 0.5 \text{ V}$; $f = 1 \text{ MHz}$)	C_{EBO}	8	8	8	pF
Noise figure ($I_C = 0.2 \text{ mA}$; $V_{CE} = 5 \text{ V}$; $R_g = 2 \text{ k}\Omega$; $\Delta f = 30 \text{ Hz to } 15 \text{ kHz}$)	NF	—	—	<4	dB
Noise figure ($I_C = 0.2 \text{ mA}$; $V_{CE} = 5 \text{ V}$; $R_g = 2 \text{ k}\Omega$; $f = 1 \text{ kHz}$; $\Delta f = 200 \text{ Hz}$)	NF	2 (<10)	2 (<10)	<4	dB

Dynamic characteristics ($T_{amb} = 25^{\circ}\text{C}$)

$I_C = 2 \text{ mA}$; $V_{CE} = 5 \text{ V}$; $f = 1 \text{ kHz}$

h_{FE} group	A	B	C	
Type	BC 167 BC 168 —	BC 167 BC 168 BC 169	— BC 168 BC 169	
h_{11e}	2.7 (1.6 to 4.5)	4.5 (3.2 to 8.5)	8.7 (6 to 16)	k Ω
h_{12e}	1.5	2	3	10^{-4}
h_{21e}	220	330	600	—
h_{22e}	18 (<30)	30 (<60)	60 (<110)	μS

The characteristic curves for these transistors comply with those for the types BC 237, BC 238, and BC 239.

BC 177, BC 178, and BC 179 are epitaxial PNP silicon planar transistors in TO 18 case (18 A 3 DIN 41 876). The collector is electrically connected to the case. The transistors are particularly suitable for use in AF input and driver stages.

Type	Ordering code
BC 177 ¹⁾	Q62702-C684
BC 177 A	Q62702-C141
BC 177 B	Q62702-C142
BC 178 ¹⁾	Q62702-C685
BC 178 A	Q62702-C153
BC 178 B	Q62702-C154
BC 178 C	Q62702-C155
BC 179 ¹⁾	Q62702-C686
BC 179 B	Q62702-C303
BC 179 C	Q62702-C145

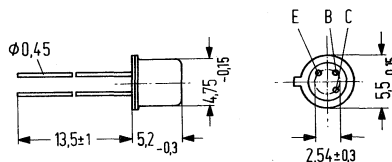

Approx. weight 0.33 g

Dimension in mm

Maximum ratings ($T_{amb} = 25^{\circ}\text{C}$)		BC 177	BC 178	BC 179	
Collector-emitter voltage	$-V_{CES}$	50	30	25	V
Collector-emitter voltage	$-V_{CEO}$	45	25	20	V
Emitter-base voltage	$-V_{EBO}$	5	5	5	V
Collector current	$-I_C$	100	100	50	mA
Collector peak current	$-I_{CM}$	200	200	—	mA
Base current	$-I_B$	50	50	5	mA
Base peak current	$-I_{BM}$	100	100	—	mA
Junction temperature	T_j	175	175	175	$^{\circ}\text{C}$
Storage temperature range	T_{stg}	-55 to +125			$^{\circ}\text{C}$
Total power dissipation	P_{tot}	300	300	300	mW
Thermal resistance					
Junction to ambient air	R_{thJA}	≤ 500	≤ 500	≤ 500	K/W
Junction to case	R_{thJC}	≤ 200	≤ 200	≤ 200	K/W

1) If the order does not include any exact indication of the current amplification group desired, a transistor of a current amplification group just available from stock will be delivered.

Static characteristics ($T_{amb} = 25^{\circ}\text{C}$)

The transistors are grouped according to the DC current gain h_{FE} and are marked with A, B, C. At $-V_{CE} = 5\text{ V}$ and the collector currents indicated below, the following static characteristics apply:

h_{FE} group	A	B	C
Type	BC 177 BC 178 =	BC 177 BC 178 BC 179	– BC 178 BC 179
$-I_C$ mA	h_{FE} I_C/I_B	h_{FE} I_C/I_B	h_{FE} I_C/I_B
0.01	90	150	270
2	170 (120 to 220)	290 (180 to 460)	500 (380 to 800)
100 ¹⁾	120 ³⁾	200 ³⁾	400 ³⁾

Static characteristics ($T_{amb} = 25^{\circ}\text{C}$)

Type	BC 177, BC 178, BC 179				
V_{CE} V	$-I_C$ mA	$-I_B$ mA	$-V_{BE}$ V	$-V_{CEsat}$ V	$-V_{BEsat}$ V
5	0.1	–	0.57	–	–
5	2	–	0.62 (0.55 to 0.7)	–	–
5	100	–	0.8	–	–
–	10	0.5	–	0.1 (<0.2) ¹⁾	0.7 (<0.8)
–	100 ³⁾	5	–	0.2 (<0.6) ¹⁾³⁾	0.85 (<1) ³⁾
5	10	–	–	0.2 (<0.6) ²⁾	–

	BC 177	BC 178	BC 179		
Collector cutoff current ($-V_{CES} = 20\text{ V}$)	$-I_{CES}$	2 (<100)	2 (<100)	2 (<100)	nA
Collector cutoff current ($-V_{CES} = 20\text{ V}$; $T_{amb} = 125^{\circ}\text{C}$)	$-I_{CES}$	<4	<4	<4	μA
Emitter-base breakdown voltage ($-I_{EB} = 10\ \mu\text{A}$)	$-V_{(BR)EBO}$	>5	>5	>5	V
Collector-emitter breakdown voltage ($-I_{CE} = 2\text{ mA}$)	$-V_{(BR)CEO}$	>45	>25	>20	V
Collector-emitter breakdown voltage ($-I_{CE} = 10\ \mu\text{A}$)	$-V_{(BR)CES}$	>50	>30	>25	V

1) The transistor is overloaded to such an extent that the DC current gain decreases to $h_{FE} = 20$.

2) $I_C = 10\text{ mA}$ for the characteristics, which passes at constant base current the point $I_C = 11\text{ mA}$; $V_{CE} = 1\text{ V}$.

3) These values do not apply to BC 179.

Dynamic characteristics ($T_{amb} = 25^{\circ}\text{C}$)		BC 177	BC 178	BC 179	
Transition frequency $(-I_C = 10\text{ mA}; -V_{CE} = 5\text{ V};$ $f = 50\text{ MHz})$					
	f_T	130	130	130	MHz
Collector-base capacitance $(-V_{CBO} = 10\text{ V}; f = 1\text{ MHz})$					
	C_{CBO}	4.5 (<7)	4.5 (<7)	4.5 (<7)	pF
Noise figure $(-I_C = 0.2\text{ mA}; -V_{CE} = 5\text{ V})$					
	$R_g = 2\text{ k}\Omega; \Delta f = 200\text{ Hz}; f = 1\text{ kHz}$	<10	<10	<4	dB
	$f = 30\text{ to }15000\text{ Hz}$	-	-	2 (<4)	dB

Dynamic characteristics ($T_{amb} = 25^{\circ}\text{C}$)

$I_C = 2\text{ mA}; V_{CB} = 5\text{ V}; f = 1\text{ kHz}$

h_{FE} group	A	B	C	
Type	BC 177 BC 178 -	BC 177 BC 178 BC 179	- BC 178 BC 179	
h_{11e}	2.7 (1.6 to 4.5)	4.5 (3.2 to 8.5)	8.7 (6 to 15)	k Ω
h_{12e}	1.5	2	3	10^{-4}
h_{21e}	220	330	600	-
h_{22e}	18 (<30)	35 (<60)	60 (<110)	μS

Total perm. power dissipation versus temperature

$P_{tot} = f(T); R_{th} = \text{parameter}$

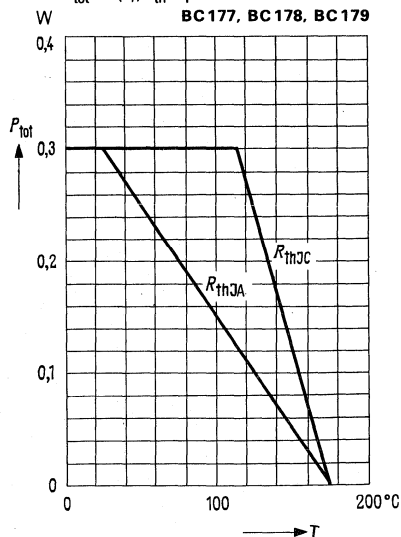

Permissible pulse load

$r_{thJC} = f(t); v = \text{parameter}$

BC177, BC178, BC179

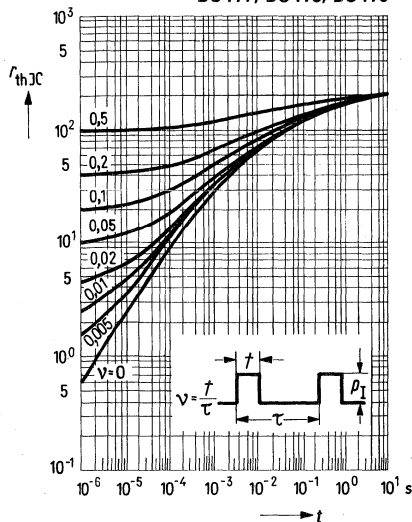

Collector current $I_C = f(V_{BE})$
 $-V_{CE} = 5\text{ V}$

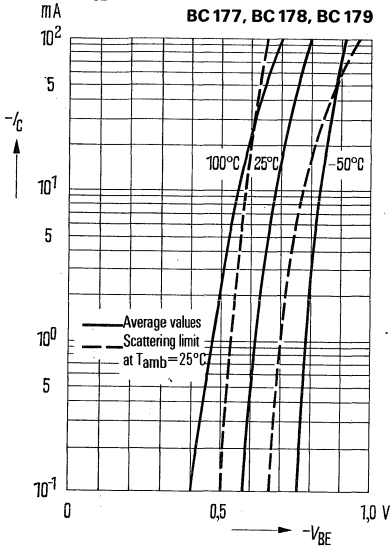

DC current gain
 $h_{FE} = f(I_C) - V_{CE} = 5\text{ V}$

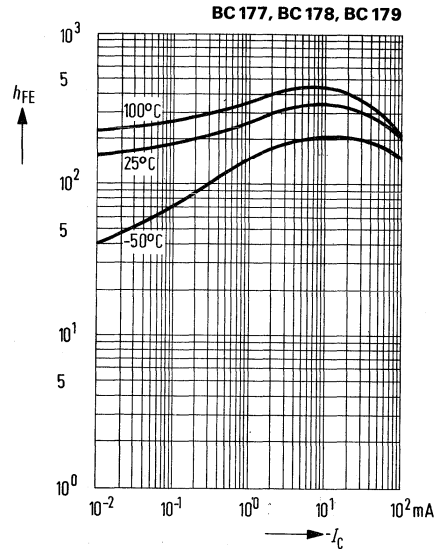

Input characteristic: $I_B = f(V_{BE})$
 $-V_{CE} = 5\text{ V}; T_{\text{amb}} = 25^\circ\text{C}$

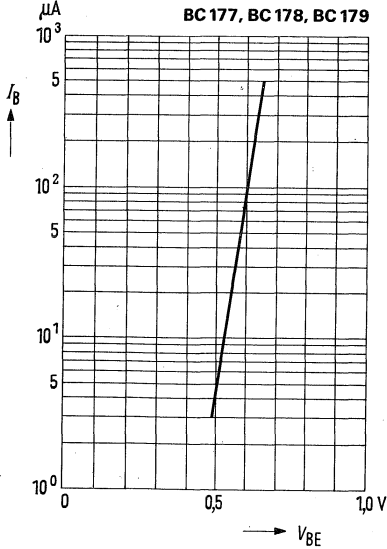

Collector cutoff current versus temperature $I_{CBO} = f(T_{\text{amb}})$
(for max. permissible reverse voltage)

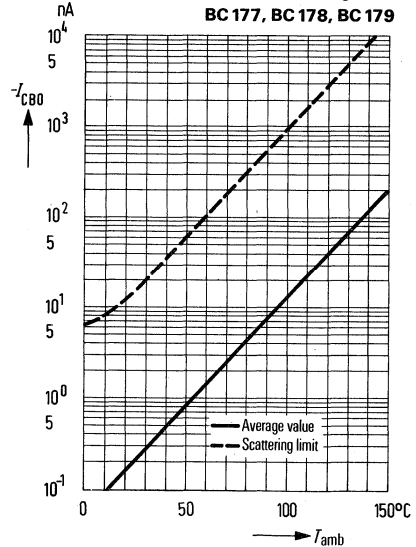

Collector-emitter saturation voltage

$V_{CEsat} = f(I_C); h_{FE} = 20$

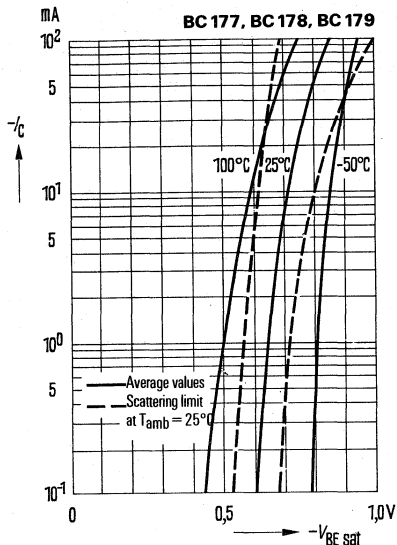
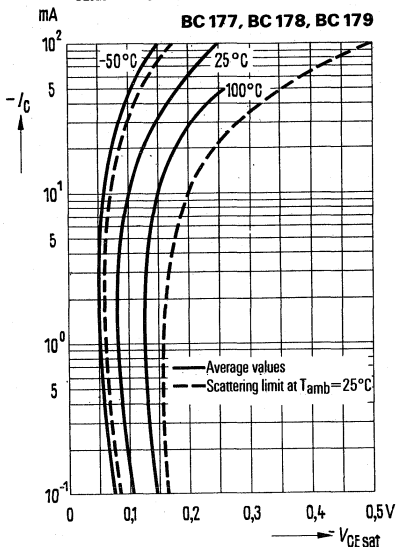

h-parameter vs. collector current

$-V_{CE} = 5\text{ V}; T_{amb} = 25^\circ\text{C}$

$H_o = \frac{h_o(I_C)}{h_o(I_C = 2\text{ mA})} = f(I_C)$

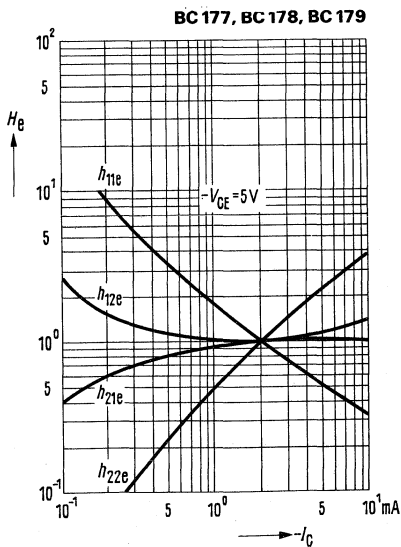

h-parameter vs. collector-emitter voltage

$-I_C = 2\text{ mA}; T_{amb} = 25^\circ\text{C}$

$H_o = \frac{h_o(V_{CE})}{h_o(V_{CE} = 5\text{ V})} = f(V_{CE})$

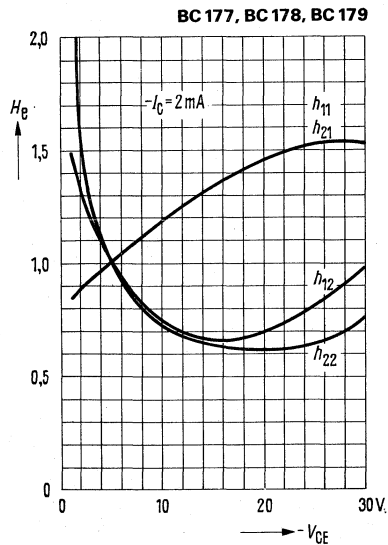

Output characteristics $I_C = f(V_{CE})$
 $I_B = \text{parameter}$

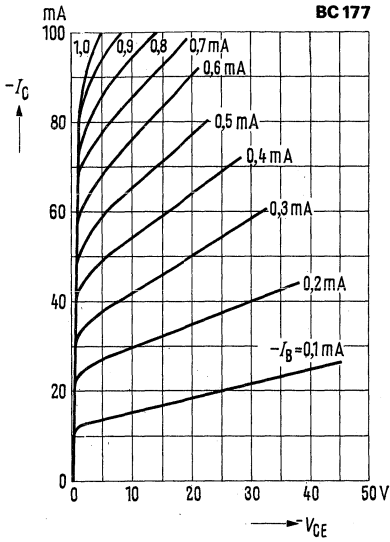

Output characteristics $I_C = f(V_{CE})$
 $I_B = \text{parameter}$

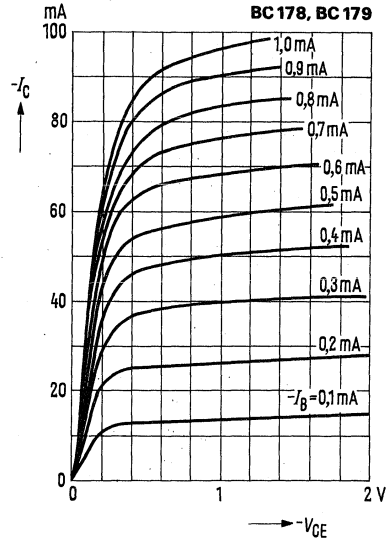

Output characteristics $I_C = f(V_{CE})$
 $V_{BE} = \text{parameter}$

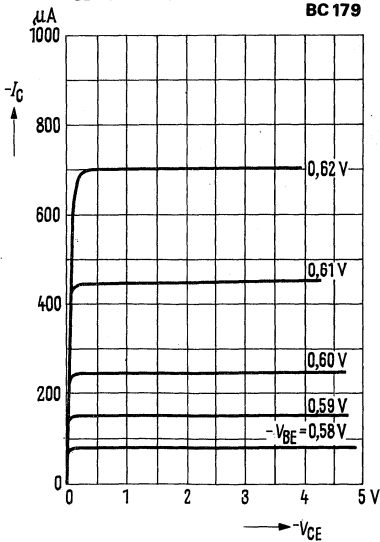

Output characteristics $I_C = f(V_{CE})$
 $I_B = \text{parameter}$

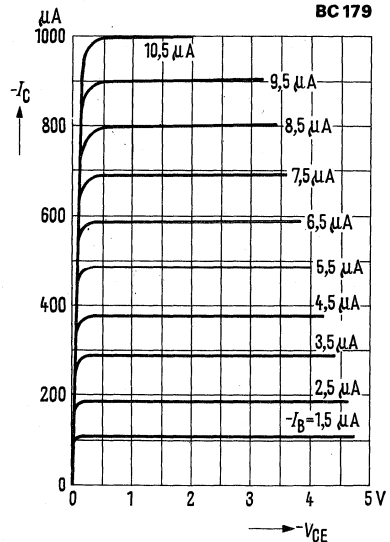

BC 177
BC 178
BC 179

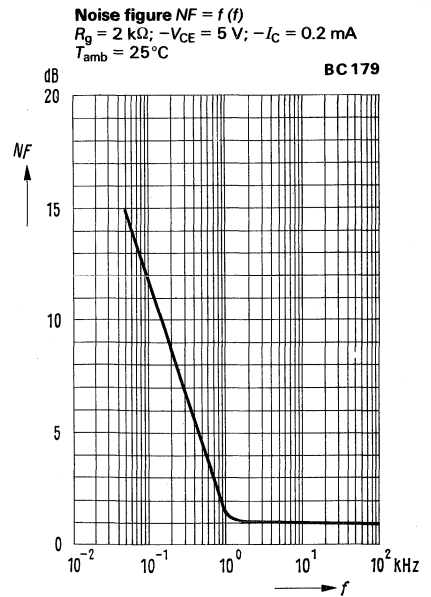
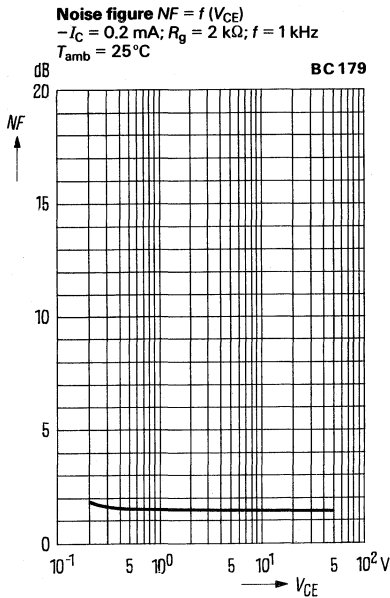
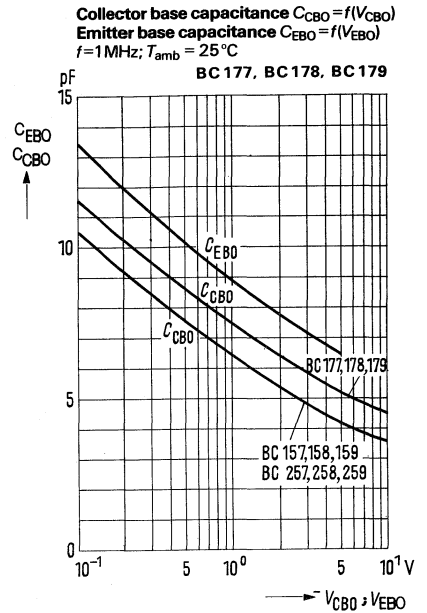
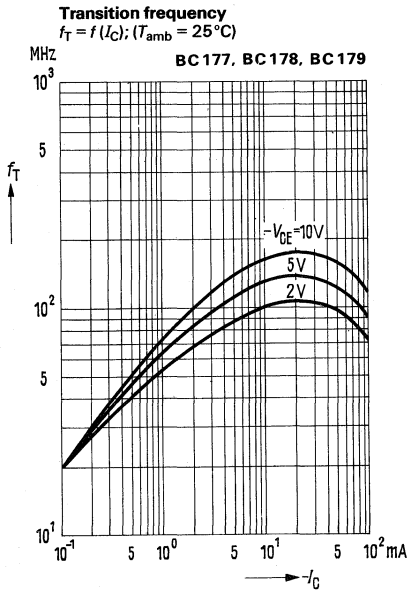

Noise figure $NF = f(I_C)$
 $-V_{CE} = 5\text{ V}; f = 120\text{ kHz}; T_{amb} = 25^\circ\text{C}$

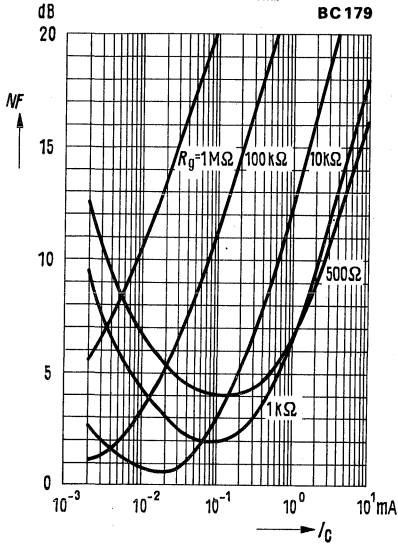

Noise figure $NF = f(I_C)$
 $-V_{CE} = 5\text{ V}; f = 1\text{ kHz}; T_{amb} = 25^\circ\text{C}$

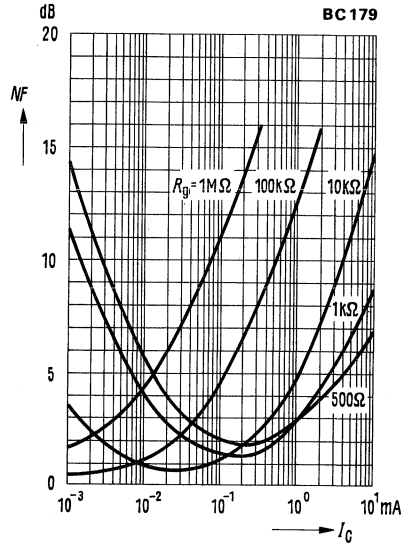

Noise figure $NF = f(I_C)$
 $-V_{CE} = 5\text{ V}; f = 10\text{ kHz}; T_{amb} = 25^\circ\text{C}$

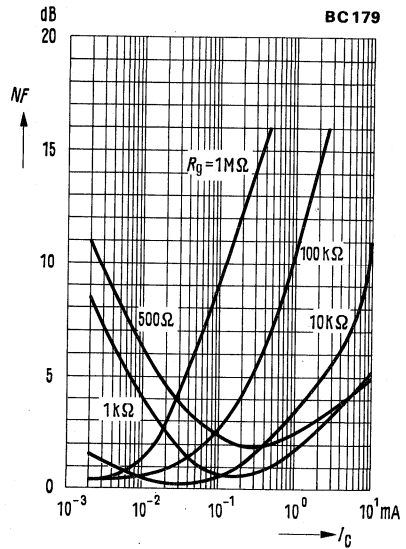

BC 182 and BC 183 are epitaxial NPN silicon planar transistors in TO 92 plastic package (10 A 3 DIN 41868). They are intended for use in AF input and driver stages as well as in DC voltage amplifiers. The transistors are provided for low-noise input stages and as complementary transistors to BC 212 and BC 213.

Type	Ordering code
BC 182 ¹⁾	Q62702-C455
BC 182 A	Q62702-C372
BC 182 B	Q62702-C373
BC 183 ¹⁾	Q62702-C833
BC 183 A	Q62702-C388
BC 183 B	Q62702-C387
BC 183 C	Q62702-C524

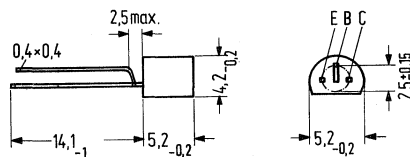

Mounting instruction: Fixing hole dia 0.6

Approx. weight 0.25 g

Dimensions in mm

Maximum ratings

	BC 182	BC 183	
Collector-emitter voltage	V_{CE0} 50	30	V
Collector-base voltage	V_{CB0} 60	45	V
Emitter-base voltage	V_{EB0} 6	6	V
Collector current	I_C 200	200	mA
Base current	I_B 50	50	mA
Junction temperature	T_j 150	150	°C
Storage temperature range	T_{stg} -65 to +150	-65 to +150	°C
Total power dissipation	P_{tot} 300	300	mW

Thermal resistance

Junction to ambient air	R_{thJA}	≤420	≤420	K/W
-------------------------	------------	------	------	-----

1) If the order does not include any exact indication of the current amplification group desired, a transistor of a current amplification group just available from stock will be delivered.

Static characteristics ($T_{amb} = 25^{\circ}\text{C}$)

The transistors are grouped in accordance with the DC current gain h_{FE} , and are marked by A and B. At $V_{CE} = 5\text{ V}$ and the collector currents indicated below the following static characteristics apply:

Type	BC 182, BC 183	BC 182, BC 183	BC 183
h_{FE} group	A	B	C
I_C (mA)	$h_{FE} I_C / I_B$	$h_{FE} I_C / I_B$	$h_{FE} I_C / I_B$
0.01	>40	150	270
2	170 (120 to 220)	290 (180 to 460)	500 (380 to 800)
100	120	200	400

Static characteristics ($T_{amb} = 25^{\circ}\text{C}$)

Type	BC 182, BC 183			
I_C (mA)	I_B (mA)	V_{BE} (V)	V_{CEsat} (V)	V_{BEsat} (V)
0.01	–	0.52	–	–
2	–	0.62 (0.55 to 0.7)	–	–
10	0.5	–	<0.25 ¹⁾	–
100	5	–	<0.6 ¹⁾	<1.2
100	–	0.82	–	–

	BC 182	BC 183	
Collector cutoff current ($V_{CB} = 50\text{ V}$)	I_{CBO}	< 15	< 15 nA
Emitter cutoff current ($V_{EB} = 4\text{ V}$)	I_{EBO}	< 15	< 15 nA
Collector-emitter breakdown voltage ($I_C = 2\text{ mA}$)	$V_{(BR)CEO}$	> 50	> 30 V
Collector-base breakdown voltage ($I_C = 10\text{ }\mu\text{A}$)	$V_{(BR)CBO}$	> 60	> 45 V
Emitter-base breakdown voltage ($I_C = 10\text{ }\mu\text{A}$)	$V_{(BR)EBO}$	> 6	> 6 V

1) The transistor is overloaded to such an extent that the DC current gain decreases to $h_{FE} = 20$.

Dynamic characteristics ($T_{amb} = 25^{\circ}\text{C}$)

$I_C = 2\text{ mA}; V_{CE} = 5\text{ V}; f = 1\text{ kHz}$

Type	BC 182 BC 183	BC 182 BC 183	BC 183	
h_{FE} group	A	B	C	
h_{11e}	2.7 (1.6 to 4.5)	4.5 (3.2 to 8.5)	8.7 (6 to 15)	k Ω
h_{12e}	1.5	2	3	10^{-4}
h_{21e}	220	330	600	—
h_{22e}	18 (<30)	30 (<60)	60 (<110)	μS

Dynamic characteristics ($T_{amb} = 25^{\circ}\text{C}$)

Transition frequency ($I_C = 10\text{ mA};$

$V_{CE} = 5\text{ V}; f = 100\text{ MHz}$)

Collector-base capacitance

($V_{CB} = 10\text{ V}; I_E = 0; f = 1\text{ MHz}$)

Emitter-base capacitance

($V_{EB} = 0.5\text{ V}; I_E = 0; f = 1\text{ MHz}$)

Noise figure ($I_C = 0.2\text{ mA};$

$V_{CE} = 5\text{ V}; f = 1\text{ kHz}; R_g = 2\text{ k}\Omega$)

	BC 182	BC 183	
f_T	> 150	> 150	MHz
C_{CBO}	2.5 (<5)	2.5 (<5)	pF
C_{EBO}	8	8	pF
NF	2 (<10)	2 (<10)	dB

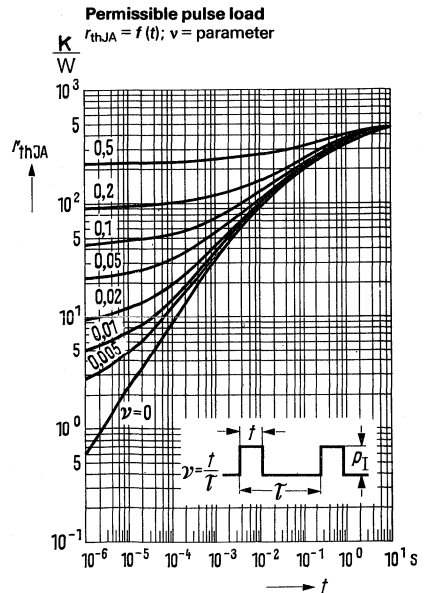
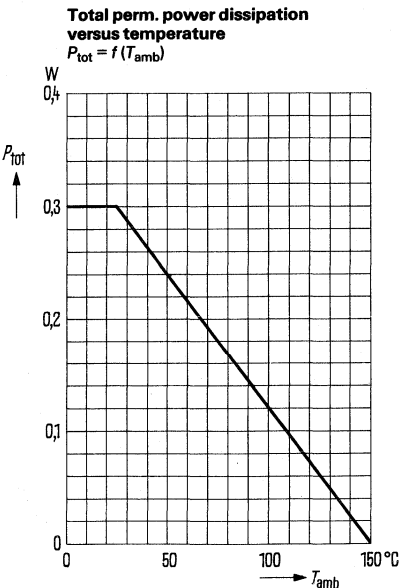

The further characteristic curves for these transistors comply with those for BC 237 and BC 238.

BC 201, BC 202, and BC 203 are epitaxial PNP silicon planar transistors of miniature design in U 32 plastic package. The types are marked by a green (BC 201), blue (BC 202), and grey (BC 203) color line on the case. The transistors are particularly intended for use in low noise AF amplifiers and as complementary transistors to BC 121, BC 122, and BC 123.

Type	Ordering code
BC 201 ¹⁾	Q62702-C149
BC 201 white	Q62702-C167
BC 201 yellow	Q62702-C168
BC 201 green	Q62702-C310
BC 201 blue	Q62702-C170
BC 202 ¹⁾	Q62702-C150
BC 202 white	Q62702-C172
BC 202 yellow	Q62702-C173
BC 202 green	Q62702-C361-X1
BC 202 blue	Q62702-C175
BC 203 ¹⁾	Q62702-C151
BC 203 white	Q62702-C177
BC 203 yellow	Q62702-C178
BC 203 green	Q62702-C362

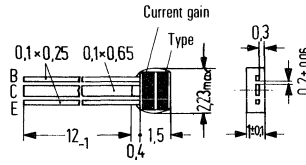

Approx. weight 20 g

Dimensions in mm

Maximum ratings		BC 201	BC 202	BC 203	
Collector-emitter voltage	$-V_{CEO}$	5	20	30	V
Collector-base voltage	$-V_{CBO}$	5	30	45	V
Emitter-base voltage	$-V_{EBO}$	5	5	5	V
Collector current	$-I_C$	75	75	75	mA
Emitter current	I_E	85	85	85	mA
Base current	$-I_B$	10	10	10	mA
Junction temperature	T_j	150	150	150	°C
Storage temperature range	T_{stg}		-55 to +125		°C
Total power dissipation [lead length "L" = 2 mm; see diagram]					
$R_{th} = f(L)$	P_{tot}	250	250	250	mW
Thermal resistance					
see diagram ²⁾ $R_{th} = f(L)$	R_{thJA}	<1000	<1000	<1000	K/W

1) If the order does not include any exact indication of the current amplification group desired, a transistor of a current amplification group just available from stock will be delivered.
(page 175)

Static characteristics ($T_{amb} = 25^{\circ}\text{C}$)

The transistors are grouped according to their small-signal current gain h_{fe} , and are marked with a color line. At a collector-emitter voltage of $V_{CE} = 2\text{ V}$ and the collector currents stated below the following static characteristics apply.

h_{fe} group	white	yellow	green	blue	
Type	BC 201 BC 202 BC 203	BC 201 BC 202 BC 203	BC 201 BC 202 BC 203	BC 201 BC 202 BC 203	BC 201 BC 202 BC 203
$-I_C$ mA	h_{fe} I_C/I_B	h_{fe} I_C/I_B	h_{fe} I_C/I_B	h_{fe} I_C/I_B	$-V_{BE}$ V
0.25	100	175	290	520	0.58 (0.52 to 0.68)

Static characteristics ($T_{amb} = 25^{\circ}\text{C}$)

Saturation voltages	$-V_{CEsat}$	$-V_{BEsat}$	
$(-I_C = 10\text{ mA}; -I_B = 0.5\text{ mA})$	0.1 (<0.2)	0.7 (<0.8)	V
$(-I_C = 50\text{ mA}; -I_B = 2.5\text{ mA})$	0.18 (<0.35)	0.8 (<0.92)	V

		BC 201	BC 202	BC 203	
Collector cutoff current ($-V_{CB} = 2\text{ V}$)	$-I_{CBO}$	2 (<100)	—	—	nA
Collector cutoff current ($-V_{CB} = 15\text{ V}$)	$-I_{CBO}$	—	2 (<100)	—	nA
Collector cutoff current ($-V_{CB} = 25\text{ V}$)	$-I_{CBO}$	—	—	2 (<100)	nA
Collector-emitter breakdown voltage ($-I_{CE} = 100\text{ }\mu\text{A}$)	$-V_{(BR)CEO}$	5	20	30	V
Collector-base breakdown voltage ($-I_{CB} = 100\text{ }\mu\text{A}$)	$-V_{(BR)CBO}$	5	30	45	V
Emitter-base breakdown voltage ($-I_{EB} = 100\text{ }\mu\text{A}$)	$-V_{(BR)EBO}$	5	5	5	V

Dynamic characteristics ($T_{amb} = 25^{\circ}\text{C}$)		BC 201	BC 202	BC 203	
Transition frequency ($-I_C = 10 \text{ mA}$; $-V_{CE} = 0.5 \text{ V}$)	f_T	80	80	80	MHz
Collector-base capacitance ($-V_{CBO} = 2 \text{ V}$; $f = 1 \text{ MHz}$)	C_{CBO}	5.4 (<11)	–	–	pF
Collector-base capacitance ($-V_{CBO} = 10 \text{ V}$; $f = 1 \text{ MHz}$)	C_{CBO}	–	3.5 (<7)	3.5 (<7)	pF
Noise figure ($-I_C = 200 \mu\text{A}$; $-V_{CE} = 0.5 \text{ V}$; $f = 1 \text{ kHz}$; $\Delta f = 200 \text{ Hz}$; $R_g = 2 \text{ k}\Omega$)	NF	2.5 (<10)	2.5 (<10)	2.5 (<10)	dB

Current-gain groups

Transistors BC 201, BC 202, BC 203 are grouped according to their small signal current gain h_{fe} , and are marked with a color line on the case.

Operating point: $-V_{CE} = 0.5 \text{ V}$; $-I_C = 250 \mu\text{A}$

Color	white	yellow	green	blue
Type	BC 201 BC 202 BC 203	BC 201 BC 202 BC 203	BC 201 BC 202 BC 203	BC 201 BC 202 –
h_{fe} group	75 to 150	125 to 260	240 to 500	450 to 900

Total perm. power dissipation versus temperature $P_{tot} = f(T_{amb})$; parameter = lead length "L"

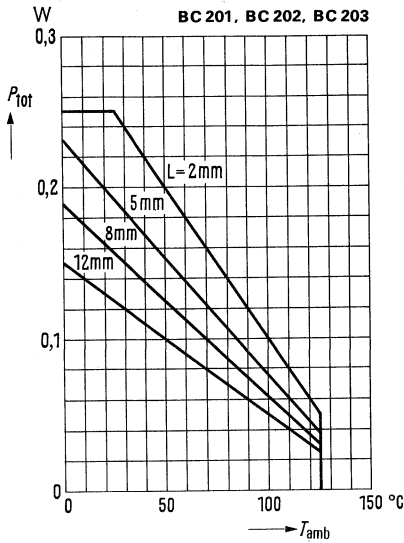

Thermal resistance $R_{th} = f(\text{lead length "L"})$

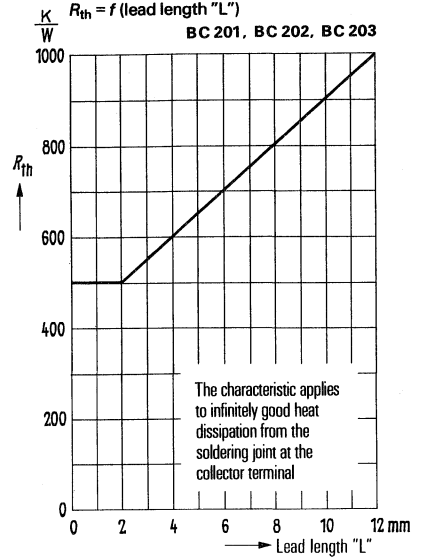

**Collector current $I_C = f(V_{BE})$
 $-V_{CE} = 5\text{ V}; T_{amb} = \text{parameter}$**

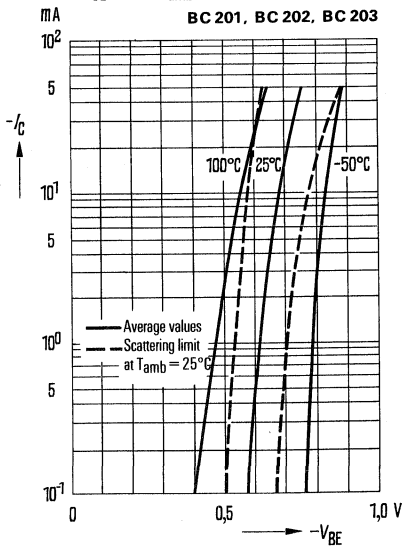

**Input characteristic $I_B = f(V_{BE})$
 $-V_{CE} = 5\text{ V}; T_{amb} = 25^\circ\text{C}$**

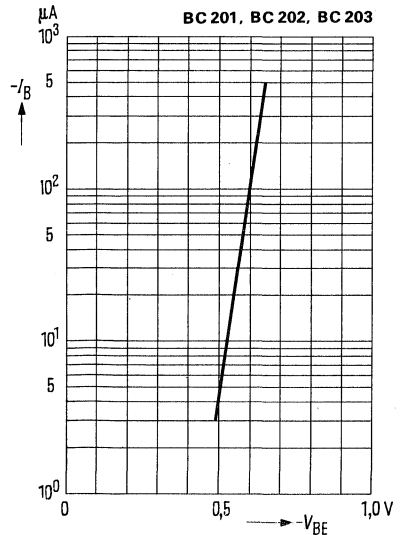

Output characteristics $I_C = f(V_{CE})$
 $I_B = \text{parameter}$

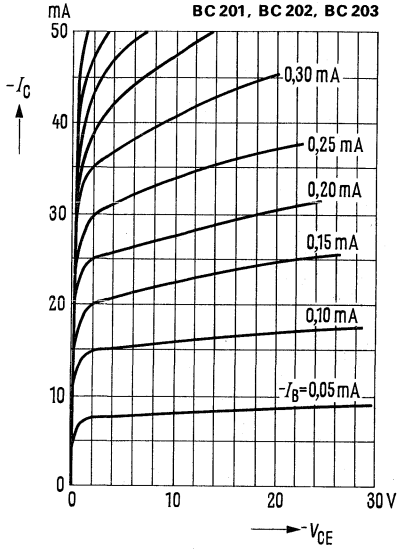

Output characteristics $I_C = f(V_{CE})$
 $I_{BE} = \text{parameter}$

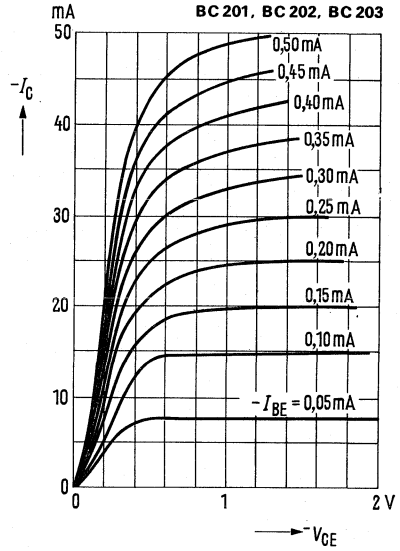

DC current gain $h_{FE} = f(I_C)$
 $-V_{CE} = 2 \text{ V}$ (characteristics based on average values)

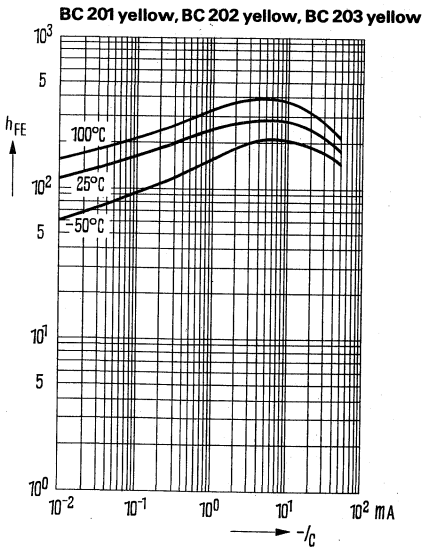

Output characteristics $I_C = f(V_{CE})$
 $V_{BE} = \text{parameter}$

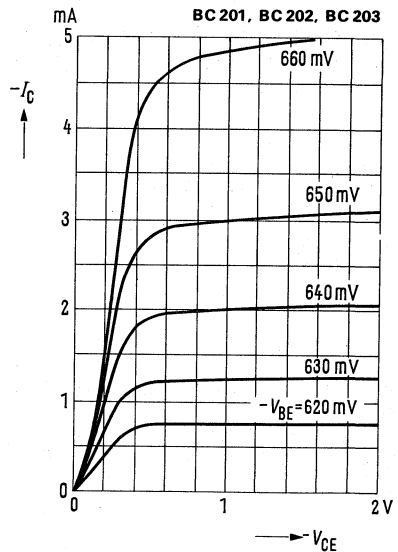

Output characteristics $I_C = f(V_{CE})$
 $I_B = \text{parameter}$

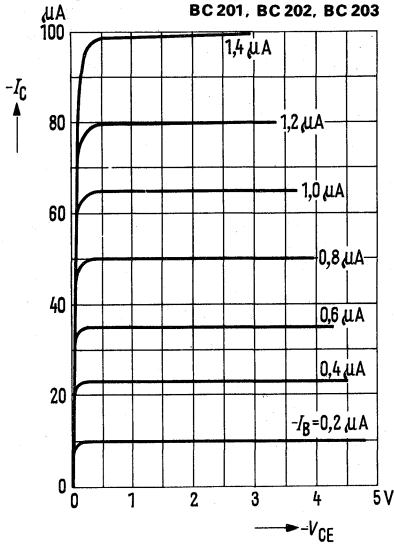

Output characteristics $I_C = f(V_{CE})$
 $I_B = \text{parameter}$

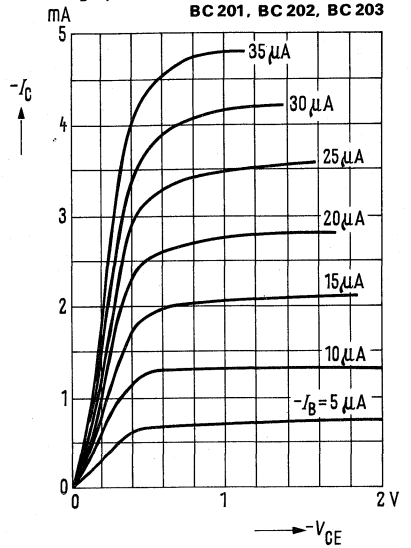

Collector-emitter saturation voltage
 $V_{CEsat} = f(I_C)$
 $h_{FE} = 20; T_{amb} = \text{parameter}$

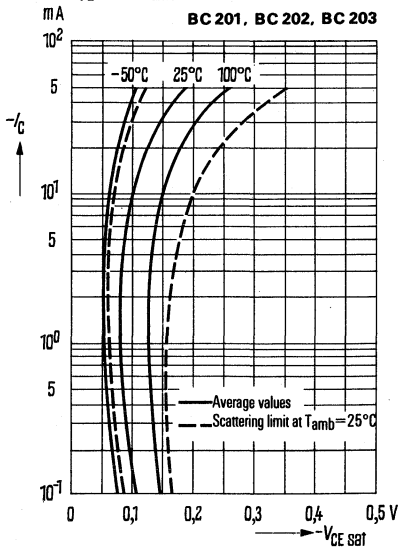

Base-emitter saturation voltage
 $V_{BEsat} = f(I_C)$
 $h_{FE} = 20; T_{amb} = \text{parameter}$

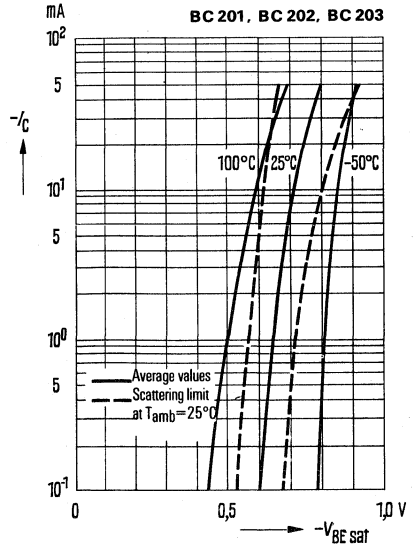

Collector cutoff current versus temperature
 $I_{CBO} = f(T_{amb})$

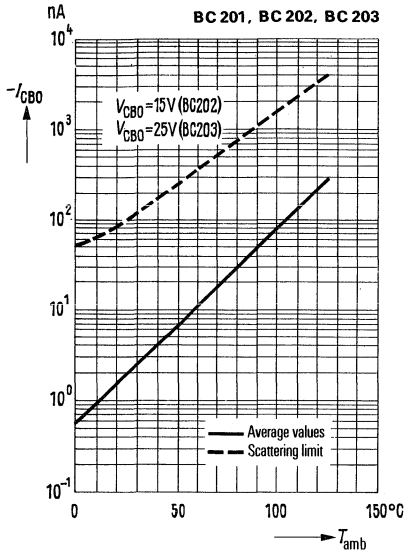

Transition frequency $f_T = f(I_C)$
 $T_{amb} = 25^\circ C; V_{CE} = \text{parameter}$

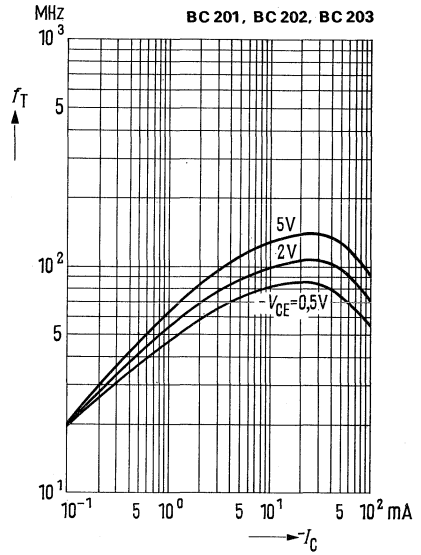

Collector-base capacitance
 $C_{CBO} = f(V_{CBO})$
Emitter-base capacitance $C_{EBO} = f(V_{EBO})$
 $f = 1\text{ MHz}; T_{amb} = 25^\circ C$

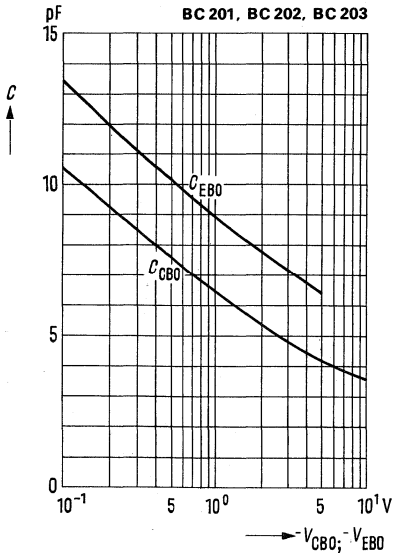

Noise figure $NF = f(I_C)$
 $-V_{CE} = 5V; f = 1\text{ kHz}; T_{amb} = 25^\circ C$

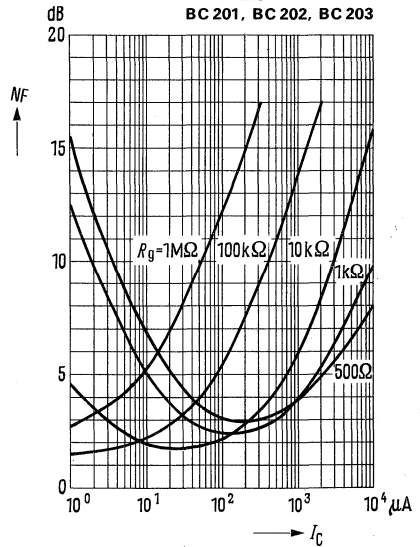

BC 201
BC 202
BC 203

Noise figure $NF = f(f)$
 $R_g = 2 \text{ k}\Omega$; $-V_{CE} = 5 \text{ V}$; $-I_C = 0.2 \text{ mA}$;
 $T_{amb} = 25^\circ\text{C}$

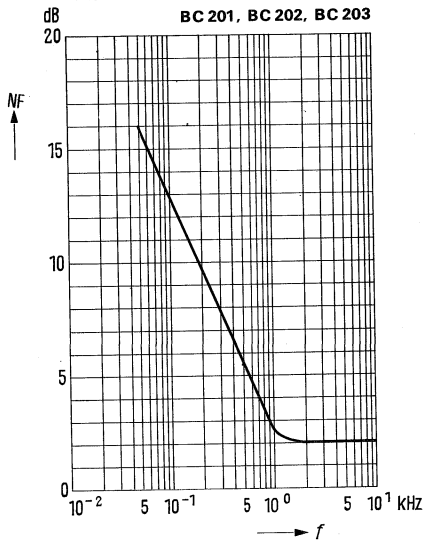

Noise figure $NF = f(V_{CE})$
 $-I_C = 0.2 \text{ mA}$; $R_g = 2 \text{ k}\Omega$; $f = 1 \text{ kHz}$;
 $T_{amb} = 25^\circ\text{C}$

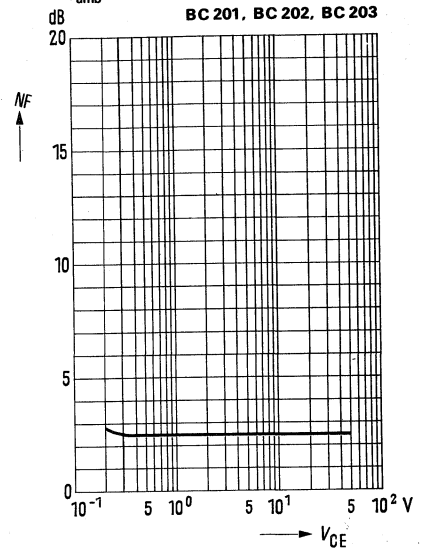

BC 212 and BC 213 are epitaxial PNP silicon planar transistors in TO 92 plastic package (10 A 3 DIN 41 868). They are intended for use in AF input and driver stages as well as in DC voltage amplifiers. The transistors are provided for low-noise input stages and as complementary transistors to BC 182 and BC 183.

Type	Ordering code
BC 212 ¹⁾	Q62702-C242
BC 212 A	Q62702-C374-V1
BC 212 B	Q62702-C374-V2
BC 213 ¹⁾	Q62702-C564
BC 213 A	Q62702-C1159
BC 213 B	Q62702-C1160
BC 213 C	Q62702-C1158

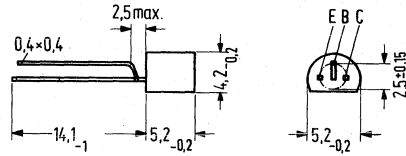

Mounting instruction: Fixing hole dia 0.6
Approx. weight 0.25 g Dimensions in mm

Maximum ratings		BC 212	BC 213	
Collector-emitter voltage	$-V_{CEO}$	50	30	V
Collector-base voltage	$-V_{CBO}$	60	45	V
Emitter-base voltage	$-V_{EBO}$	5	6	V
Collector current	$-I_C$	200	200	mA
Base current	$-I_B$	50	50	mA
Junction temperature	T_j	150	150	°C
Storage temperature range	T_{stg}	-65 to +150	-65 to +150	°C
Total power dissipation	P_{tot}	300	300	mW

Thermal resistance				
Junction to ambient air	R_{thJA}	≤420	≤420	K/W

1) If the order does not include any exact indication of the current amplification group desired, a transistor of a current amplification group just available from stock will be delivered.

Static characteristics ($T_{amb} = 25^{\circ}\text{C}$)

The transistors are grouped in accordance with the DC current gain h_{FE} , and are marked by A, B, and C. At $-V_{CE} = 5\text{ V}$ and the collector currents indicated below the following static characteristics apply:

Type	BC 212, BC 213	BC 212, BC 213	BC 213
h_{FE} group	A	B	C
$-I_C$ (mA)	$h_{FE} (I_C/I_B)$	$h_{FE} (I_C/I_B)$	$h_{FE} (I_C/I_B)$
0.01	> 90	150	270
2	170 (120 to 220)	290 (180 to 460)	500 (380 to 800)
100	120	200	400

Static characteristics ($T_{amb} = 25^{\circ}\text{C}$)

Type	BC 212, BC 213			
$-I_C$ (mA)	$-I_B$ (mA)	$-V_{BE}$ (V)	$-V_{CEsat}$ (V)	$-V_{BEsat}$ (V)
0.01	—	0.57	—	—
2	—	0.62 (0.55 to 0.7)	—	—
100	5	—	< 0.6 ¹⁾	< 1.1
100	—	0.82	—	—

	BC 212	BC 213	
Collector cutoff current ($-V_{CB} = 30\text{ V}$)	$-I_{CBO}$	< 15	< 15 nA
Emitter cutoff current ($-V_{EB} = 4\text{ V}$)	$-I_{EBO}$	< 15	< 15 nA
Collector-emitter breakdown voltage ($-I_C = 2\text{ mA}$)	$-V_{(BR)CEO}$	> 50	> 30 V
Collector-base breakdown voltage ($-I_C = 10\text{ }\mu\text{A}$)	$-V_{(BR)CBO}$	> 60	> 45 V
Emitter-base breakdown voltage ($-I_C = 10\text{ }\mu\text{A}$)	$-V_{(BR)EBO}$	> 5	> 5 V

1) The transistors is overloaded to such an extent that the DC current gain decreases to $h_{FE} = 20$.

Dynamic characteristics ($T_{amb} = 25^{\circ}\text{C}$)

$-I_C = 2\text{ mA}; -V_{CE} = 5\text{ V}; f = 1\text{ kHz}$

Type	BC 212, BC 213	BC 212, BC 213	BC 213	
h_{FE} group	A	B	C	
h_{11e}	2.7 (1.6 to 4.5)	4.5 (3.2 to 8.5)	8.7 (6 to 15)	k Ω
h_{12e}	1.5	2	3	10^{-4}
h_{21e}	220	330	600	—
h_{22e}	18 (<30)	30 (<60)	60 (<110)	μS

Dynamic characteristics ($T_{amb} = 25^{\circ}\text{C}$)

Transition frequency ($-I_C = 10\text{ mA};$

$-V_{CE} = 5\text{ V}; f = 100\text{ MHz}$)

Collector-base capacitance

($-V_{CB} = 10\text{ V}; I_E = 0; f = 1\text{ MHz}$)

Emitter-base capacitance

($-V_{EB} = 0.5\text{ V}; I_E = 0; f = 1\text{ MHz}$)

Noise figure ($-I_C = 0.2\text{ mA};$

$-V_{CE} = 5\text{ V}; f = 1\text{ kHz}; R_g = 2\text{ k}\Omega$)

	BC 212	BC 213	
f_T	> 200	> 200	MHz
C_{CBO}	4 (<6)	4 (<6)	pF
C_{EBO}	8	8	pF
NF	2 (<10)	2 (<10)	dB

Total perm. power dissipation versus temperature
 $P_{tot} = f(T_{amb})$

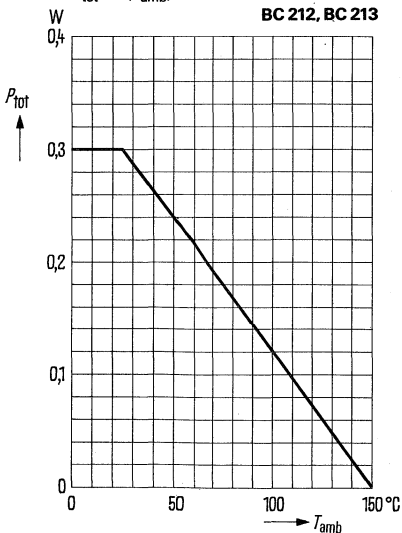

Permissible pulse load
 $r_{thJA} = f(t); v = \text{parameter}$

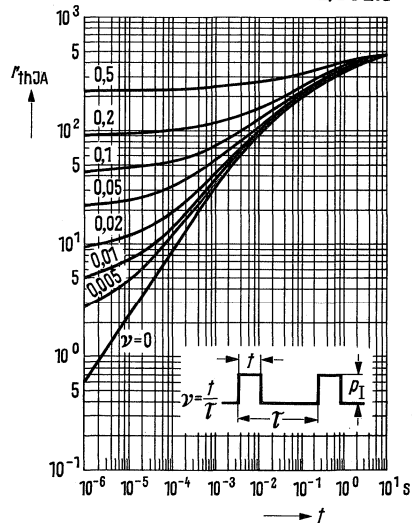

The further characteristic curves for these transistors comply with those of the types BC 307 and BC 308.

BC 237, BC 238, and BC 239 are epitaxial NPN silicon planar transistors in TO 92 plastic packages (10 A 3 DIN 41 868). They are intended for use in AF input and driver stages and as complementary transistors to BC 307, BC 308, and BC 309.

BC 239 is provided for low-noise input stages.

Type	Ordering code
BC 237 ¹⁾	Q62702-C697
BC 237 A	Q62702-C276
BC 237 B	Q62702-C277
BC 238 ¹⁾	Q62702-C698
BC 238 A	Q62702-C278
BC 238 B	Q62702-C279
BC 238 C	Q62702-C280
BC 239 ¹⁾	Q62702-C699
BC 239 B	Q62702-C281
BC 239 C	Q62702-C282

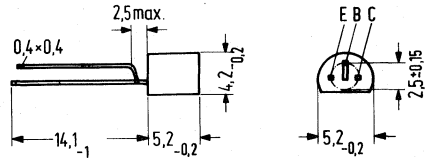

Mounting instruction: Fixing hole dia 0.6

Approx. weight 0.25 g

Dimensions in mm

Maximum ratings

		BC 237	BC 238	BC 239	
Collector-emitter voltage	V_{CES}	50	30	30	V
Collector-emitter voltage	V_{CEO}	45	20	20	V
Emitter-base voltage	V_{EBO}	6	5	5	V
Collector current	I_C	100	100	50	mA
Collector peak current	I_{CM}	200	200	—	mA
Base current	I_B	50	50	5	mA
Junction temperature	T_j	150	150	150	°C
Storage temperature range	T_{stg}		-55 to +150		°C
Total power dissipation	P_{tot}	300	300	300	mW

Thermal resistance

Junction to ambient air	R_{thJA}	≤420	≤420	≤420	K/W
-------------------------	------------	------	------	------	-----

1) If the order does not include any exact indication of the current amplification group desired, a transistor of a current amplification group just available from stock will be delivered.

Static characteristics ($T_{amb} = 25^{\circ}\text{C}$)

The transistors are grouped in accordance with the DC current gain h_{FE} and marked by A, B, and C. At $V_{CE} = 5\text{ V}$ and the collector currents indicated below the following static characteristics apply:

h_{FE} group	A	B	C
Type	BC 237 BC 238 –	BC 237 BC 238 BC 239	– BC 238 BC 239
I_C mA	h_{FE} I_C/I_B	h_{FE} I_C/I_B	h_{FE} I_C/I_B
0.01	90	150	270
2	170 (120 to 220)	290 (180 to 460)	500 (380 to 800)
100 ²⁾	120	200 ²⁾	400 ²⁾

Static characteristics ($T_{amb} = 25^{\circ}\text{C}$)

Type	BC 237, BC 238, BC 239					
V_{CE} V	I_C mA	V_{BE} V	I_C mA	I_B mA	$V_{CEsat}^{1)}$ V	$V_{BEsat}^{1)}$ V
5	0.1	0.5	10	0.5	0.07 (<0.2)	0.73 (<0.83)
5	2	0.62(0.55 to 0.7)				
5	100	0.83	100 ²⁾	5	0.2 (<0.6) ²⁾	0.87 (<1.05) ²⁾

	BC 237	BC 238	BC 239
Collector cutoff current ($V_{CES} = 50\text{ V}$)			
Collector cutoff current ($V_{CES} = 30\text{ V}$)	I_{CES} 0.2 (<15)	–	– nA
Collector cutoff current ($V_{CES} = 50\text{ V}$, $T_{amb} = 125^{\circ}\text{C}$)	I_{CES} –	0.2 (<15)	0.2 (<15) nA
Collector cutoff current ($V_{CES} = 30\text{ V}$; $T_{amb} = 125^{\circ}\text{C}$)	I_{CES} 0.05 (<4)	–	– μA
Emitter-base breakdown voltage ($I_{EBO} = 1\ \mu\text{A}$)	$V_{(BR)EBO}$ >6	>5	>5 V
Collector-emitter breakdown voltage ($I_{CEO} = 2\text{ mA}$)	$V_{(BR)CEO}$ >45	>20	>20 V

1) The transistor is overloaded to such an extent that the DC current gain decreases to $h_{FE} = 20$.

2) These values do not apply to BC 239.

Dynamic characteristics ($T_{amb} = 25^\circ\text{C}$)	BC 237	BC 238	BC 239	
Transition frequency ($I_C = 0.5\text{ mA}$; $V_{CE} = 3\text{ V}$)	f_T 85	85	85	kHz
Transition frequency ($I_C = 10\text{ mA}$; $V_{CE} = 5\text{ V}$; $f = 100\text{ MHz}$)	f_T 250 (>150)	250 (<150)	300 (<150)	MHz
Collector-base capacitance ($V_{CBO} = 10\text{ V}$; $f = 1\text{ MHz}$)	C_{CBO} <4.5	<4.5	<4.5	pF
Emitter-base capacitance ($V_{EBO} = 0.5\text{ V}$; $f = 1\text{ MHz}$)	C_{EBO} 8	8	8	pF
Noise figure ($I_C = 0.2\text{ mA}$; $V_{CE} = 5\text{ V}$; $R_g = 2\text{ k}\Omega$; $\Delta f = 30\text{ Hz to }15\text{ kHz}$)	NF -	-	<4	dB
Noise figure ($I_C = 0.2\text{ mA}$; $V_{CE} = 5\text{ V}$; $R_g = 2\text{ k}\Omega$; $f = 1\text{ kHz}$; $\Delta f = 200\text{ Hz}$)	NF 2 (<10)	2 (<10)	<4	dB

Operating point: $I_C = 2\text{ mA}$; $V_{CE} = 5\text{ V}$; $f = 1\text{ kHz}$:

h_{FE} group	A	B	C	
Type	BC 237 BC 238 -	BC 237 BC 238 BC 239	- BC 238 BC 239	
h_{11e}	2.7 (1.6 to 4.5)	4.5 (3.2 to 8.5)	8.7 (6 to 15)	k Ω
h_{12e}	1.5	2	3	10^{-4}
h_{21e}	220	330	600	-
h_{22e}	18 (<30)	30 (<60)	60 (<110)	μS

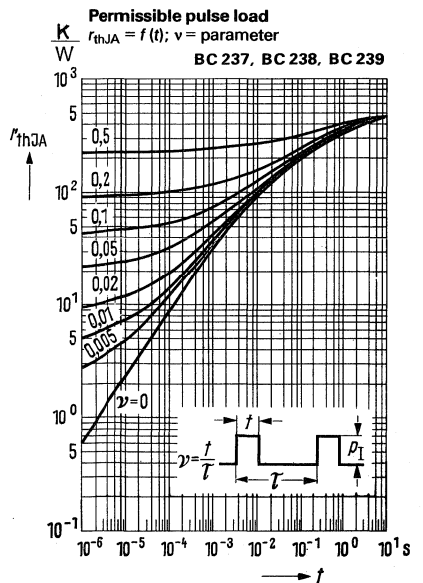
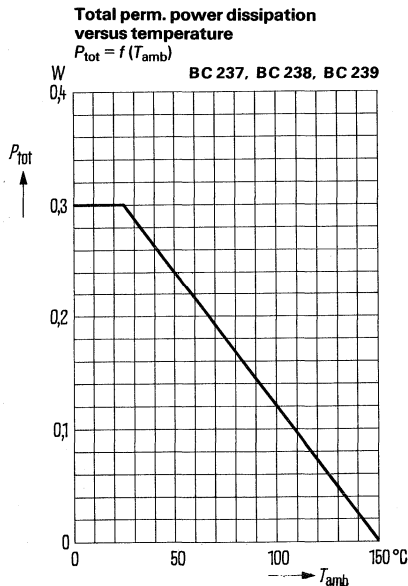

BC 237
BC 238
BC 239

DC current gain $h_{FE} = f(I_C)$
 $V_{CE} = 5 \text{ V}$; $T_{amb} = \text{parameter}$
 (common emitter configuration)

BC 237, BC 238, BC 239

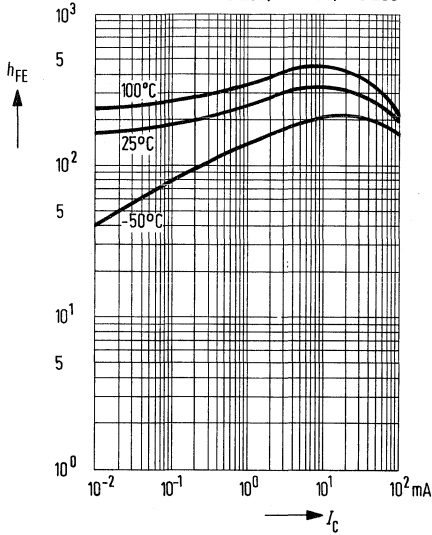

Output characteristics $I_C = f(V_{CE})$
 $I_B = \text{parameter}$
 (common emitter configuration)

BC 237, BC 238, BC 239

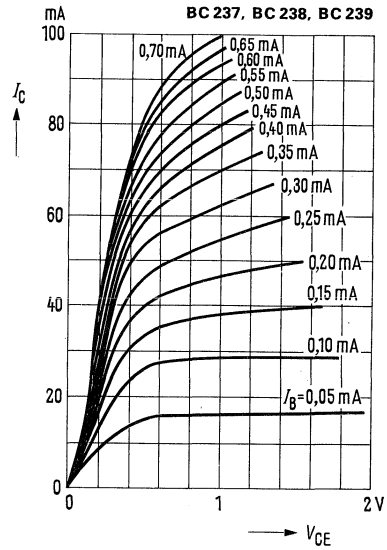

Collector current $I_C = f(V_{BE})$
 $V_{CE} = 5 \text{ V}$
 (common emitter configuration)

BC 237, BC 238, BC 239

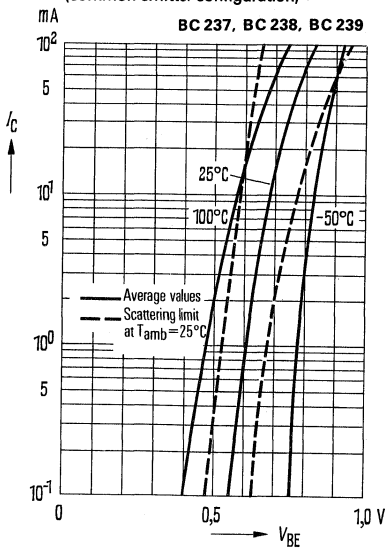

Output characteristics $I_C = f(V_{CE})$
 $I_B = \text{parameter}$
 (common emitter configuration)

BC 237

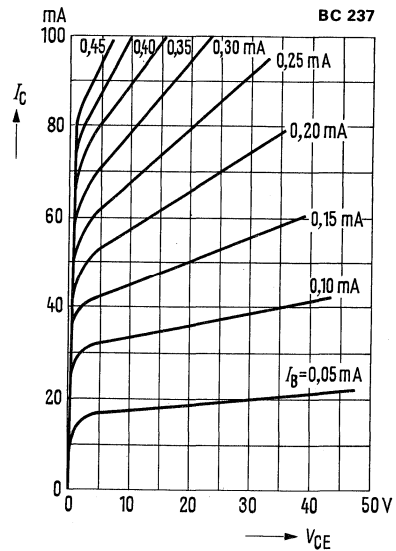

Output characteristics $I_C = f(V_{CE})$
 $I_B = \text{parameter}$
 (common emitter configuration)

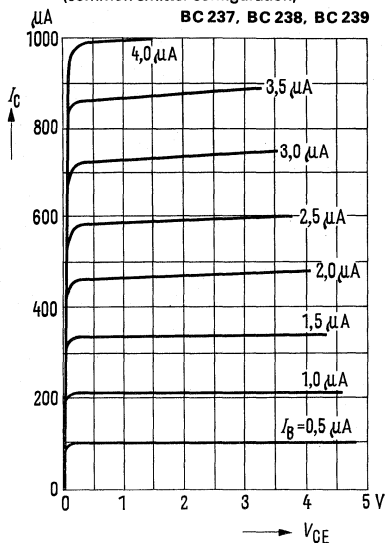

Output characteristics $I_C = f(V_{CE})$
 $V_{BE} = \text{parameter}$
 (common emitter configuration)

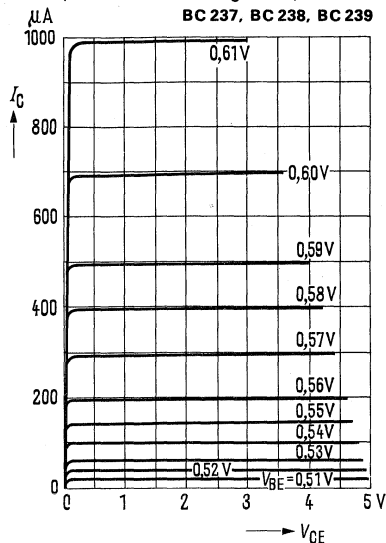

Collector-emitter saturation voltage
 $V_{CEsat} = f(I_C); h_{FE} = 20$
 $T_{amb} = \text{parameter}$
 (common emitter configuration)

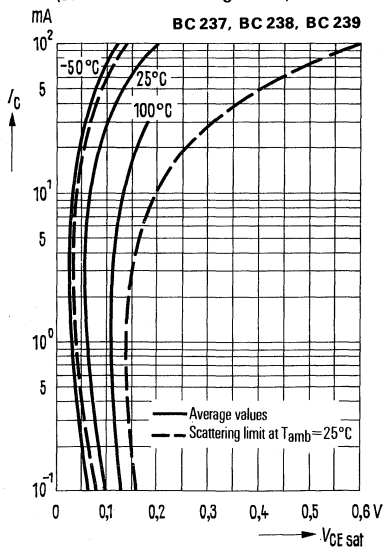

Base-emitter saturation voltage
 $V_{BEsat} = f(I_C); T_{amb} = \text{parameter};$
 $h_{FE} = 20$
 (common emitter configuration)

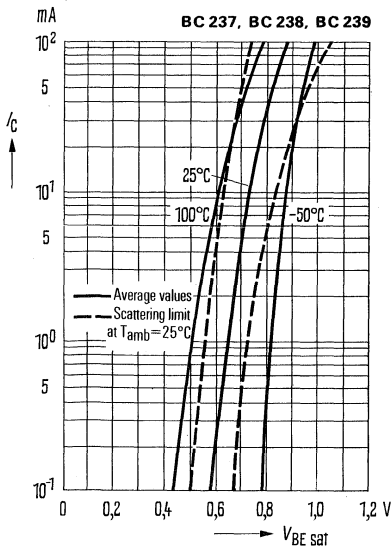

BC 237
BC 238
BC 239

Input characteristic $I_B = f(V_{BE})$
 $V_{CE} = 5\text{ V}$
 (common emitter configuration)

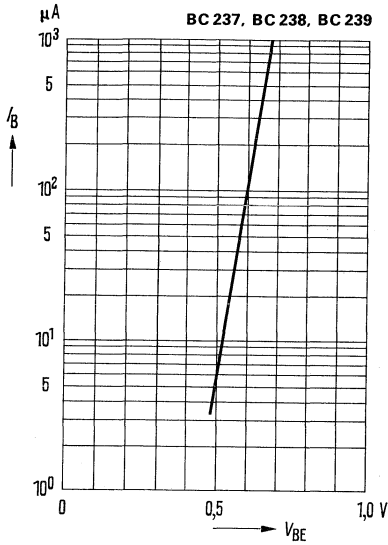

Transition frequency $f_T = f(I_C)$
 $V_{CE} = \text{parameter}$

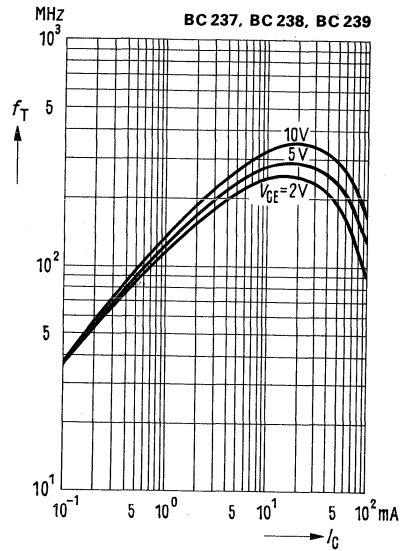

Collector-base capacitance

$C_{CBO} = f(V_{CBO})$
 $C_{EBO} = f(V_{EBO})$
 Emitter-base capacitance $C_{EBO} = f(V_{EBO})$

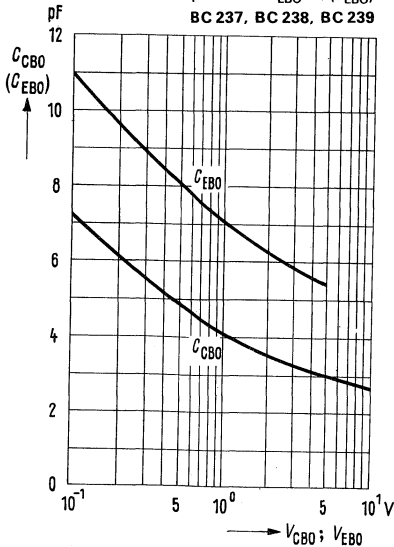

Collector cutoff current versus temperature

$I_{CBO} = f(T_{amb})$ for max. permissible reverse voltage

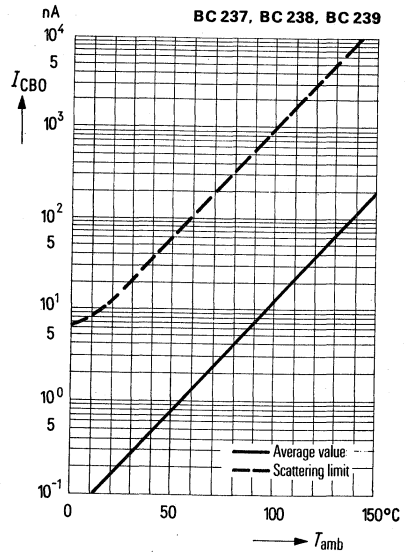

***h*-parameter versus collector-emitter voltage**

$$H_e = \frac{h_e(V_{CE})}{h_e(V_{CE}=5V)} = f(V_{CE})$$

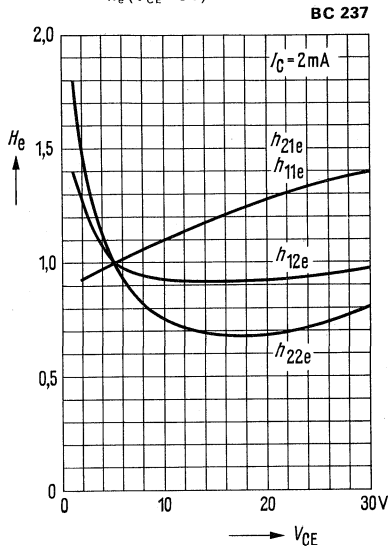

***h*-parameter versus collector current**

$$H_e = \frac{h_e(I_C)}{h_e(I_C=2\text{ mA})} = f(I_C)$$

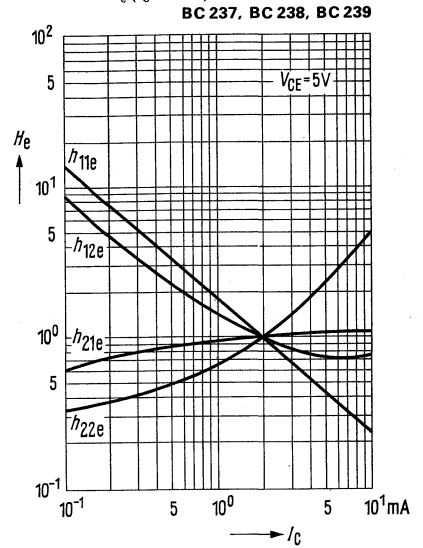

Noise figure $NF = f(I_C)$
 $V_{CE} = 5\text{ V}; f = 1\text{ kHz}$

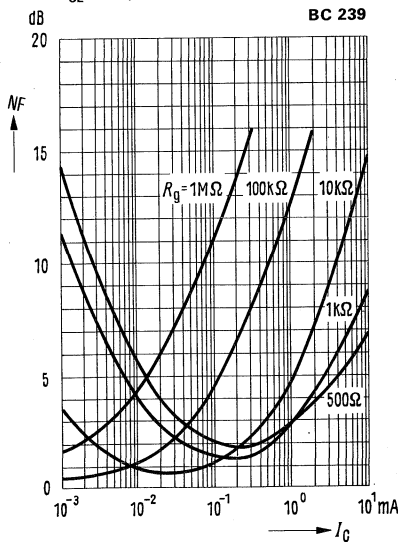

Noise figure $NF = f(I_C)$
 $V_{CE} = 5\text{ V}; f = 120\text{ Hz}$

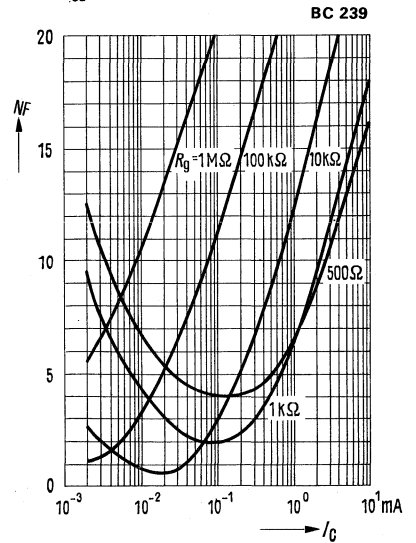

Noise figure $NF = f(V_{CE})$
 $I_C = 0.2 \text{ mA}$; $R_g = 2 \text{ k}\Omega$; $f = 1 \text{ kHz}$
 $\Delta f = 200 \text{ Hz}$; $T_{amb} = 25^\circ\text{C}$

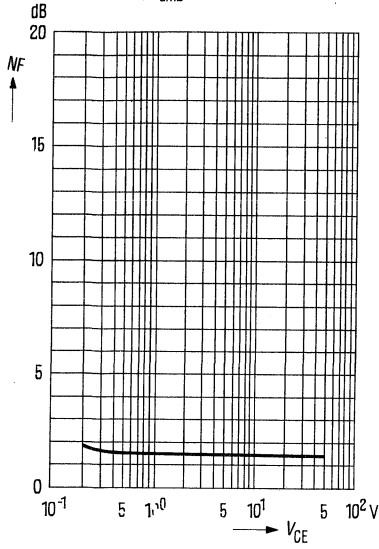

Noise figure $NF = f(f)$
 $V_{CE} = 5 \text{ V}$; $I_C = 0.2 \text{ mA}$
 $R_g = 2 \text{ k}\Omega$; $T_{amb} = 25^\circ\text{C}$

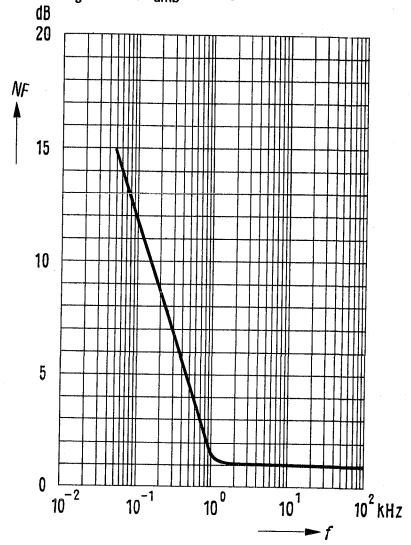

Noise figure $NF = f(I_C)$
 $V_{CE} = 5 \text{ V}$; $f = 10 \text{ kHz}$

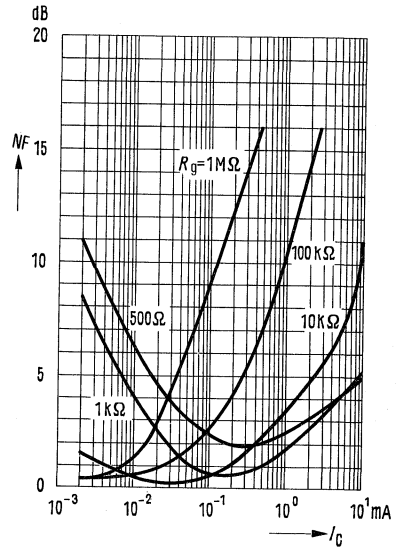

BC 257, BC 258, and BC 259 are epitaxial PNP silicon planar transistors in TO 92 plastic packages (10 A 3 DIN 41868). They are intended for use in AF input and driver stages and as complementary transistors to BC 167, BC 168, and BC 169.

BC 259 is provided for low-noise input stages.

Type	Ordering code
BC 257 ¹⁾	Q62702-C700
BC 257 A	Q62702-C184
BC 257 B	Q62702-C206
BC 258 ¹⁾	Q62702-C701
BC 258 A	Q62702-C187
BC 258 B	Q62702-C188
BC 258 C	Q62702-C438
BC 259 ¹⁾	Q62702-C702
BC 259 B	Q62702-C192
BC 259 C	Q62702-C439

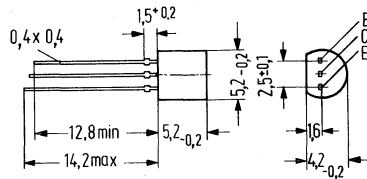

Approx. weight 0.25 g

Dimensions in mm

For mounting instructions and hole diameter refer to "Introduction"

Maximum ratings

		BC 257	BC 258	BC 259	
Collector-emitter voltage	$-V_{CES}$	50	30	25	V
Collector-emitter voltage	$-V_{CEO}$	45	25	20	V
Emitter-base voltage	$-V_{EBO}$	5	5	5	V
Collector current	$-I_C$	100	100	50	mA
Collector peak current	$-I_{CM}$	200	200	-	mA
Base current	$-I_B$	50	50	5	mA
Base peak current	$-I_{BM}$	100	100	-	mA
Junction temperature	T_j	150	150	150	°C
Storage temperature range	T_{stg}		-55 to +150		°C
Total power dissipation	P_{tot}	300	300	300	mW

Thermal resistance

Junction to ambient air	R_{thJA}	≤ 420	≤ 420	≤ 420	K/W
-------------------------	------------	-------	-------	-------	-----

1) If the order does not include any exact indication of the current amplification group desired, a transistor of a current amplification group just available from stock will be delivered.

Static characteristics ($T_{amb} = 25^{\circ}\text{C}$)

The transistors are grouped in accordance with the DC current gain h_{FE} and marked by A, B, and C. At $-V_{CE} = 5\text{ V}$ and the collector currents indicated below the following static characteristics apply:

h_{FE} group	A	B	C
Type	BC 257 BC 258 –	BC 257 BC 258 BC 259	– BC 258 BC 259
$-I_C$ mA	h_{FE} I_C/I_B	h_{FE} I_C/I_B	h_{FE} I_C/I_B
0.01	90	150	270
2	170 (120 to 220)	290 (180 to 460)	500 (380 to 800)
100 ³⁾	120 ³⁾	300 ³⁾	400 ³⁾

Static characteristics ($T_{amb} = 25^{\circ}\text{C}$)

Type	BC 257, BC 258, BC 259				
V_{CE} V	$-I_C$ mA	$-I_B$ mA	$-V_{BE}$ V	$-V_{CEsat}$ V	$-V_{BEsat}$ V
5	0.1	–	0.57	–	–
5	2	–	0.62 (0.55 to 0.7)	–	–
5	100	–	0.8	–	–
–	10	0.5	–	0.1 (<0.2) ¹⁾	0.7 (<0.8)
–	100 ³⁾	5	–	0.2 (<0.6) ¹⁾³⁾	0.85 (<1) ³⁾
5	10	–	–	0.2 (<0.6) ²⁾	–

	BC 257	BC 258	BC 259		
Collector cutoff current ($-V_{CES} = 20\text{ V}$)	$-I_{CES}$	2 (<100)	2 (<100)	2 (<100)	nA
Collector cutoff current ($-V_{CES} = 20\text{ V}$; $T_{amb} = 125^{\circ}\text{C}$)	$-I_{CES}$	<4	<4	<4	μA
Emitter-base breakdown voltage ($-I_{EB} = 10\ \mu\text{A}$)	$-V_{(BR)EBO}$	>5	>5	>5	V
Collector-emitter breakdown voltage ($-I_{CE} = 2\text{ mA}$)	$-V_{(BR)CEO}$	>45	>25	>20	V
Collector-emitter breakdown voltage ($-I_{CE} = 10\ \mu\text{A}$)	$-V_{(BR)CES}$	>50	>30	>25	V

1) The transistor is overloaded to such an extent that the DC current gain decreases to $h_{FE} = 20$.

2) Collector emitter saturation voltage at $I_C = 10\text{ mA}$ for the characteristic which, at a constant base current, intersects the point of the characteristic where $I_C = 11\text{ mA}$; $V_{CE} = 1\text{ V}$.

3) These values do not apply to BC 259.

Dynamic characteristics ($T_{amb} = 25^{\circ}\text{C}$)

$I_C = 2 \text{ mA}; V_{CB} = 5 \text{ V}; f = 1 \text{ kHz}$

h_{FE} group	A	B	C	
Type	BC 257 BC 258 -	BC 257 BC 258 BC 259	- BC 258 BC 259	
h_{11e}	2.7 (1.6 to 4.5)	4.5 (3.2 to 8.5)	8.7 (6 to 15)	k Ω
h_{12e}	1.5	2	3	10^{-4}
h_{21e}	220	330	600	-
h_{22e}	18 (<30)	35 (<60)	60 (<110)	μS

Dynamic characteristics ($T_{amb} = 25^{\circ}\text{C}$)

	BC 257	BC 258	BC 259		
Transition frequency ($-I_C = 10 \text{ mA}; -V_{CE} = 5 \text{ V}; f = 50 \text{ MHz}$)	f_T	130	130	130	MHz
Collector-base capacitance ($-V_{CB0} = 10 \text{ V}; f = 1 \text{ MHz}$)	C_{CBO}	<6	<6	<6	pF
Noise figure ($-I_C = 0.2 \text{ mA}; -V_{CE} = 5 \text{ V}; R_g = 2 \text{ k}\Omega; \Delta f = 200 \text{ Hz}; f = 1 \text{ kHz}$)	NF	<10	<10	<4	dB
$f = 30 \text{ to } 15000 \text{ Hz}$	NF	-	-	2 (<4)	dB

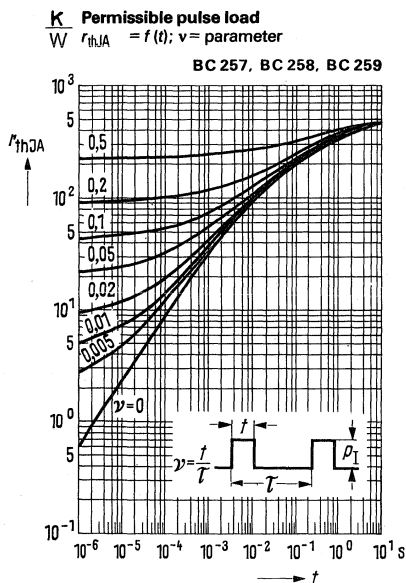
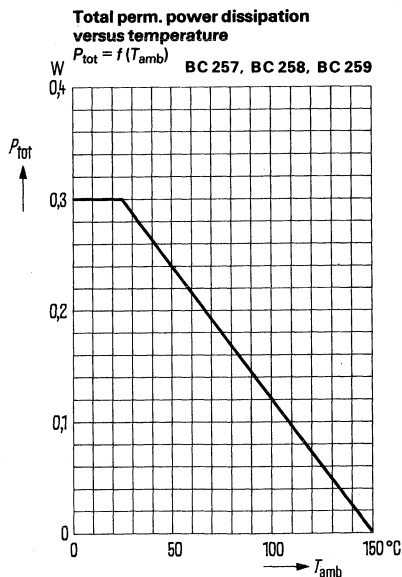

The curves for these transistors comply with those of the types BC 307, BC 308, and BC 309.

BC 307, BC 308, and BC 309 are epitaxial PNP silicon planar transistors in TO 92 plastic packages (10 A 3 DIN 41868). They are intended for use in AF input and driver stages and as complementary transistors to BC 237, BC 238, and BC 239.

BC 309 is provided for low-noise input stages.

Type	Ordering code
BC 307 ¹⁾	Q62702-C703
BC 307 A	Q62702-C283
BC 307 B	Q62702-C324
BC 308 ¹⁾	Q62702-C704
BC 308 A	Q62702-C285
BC 308 B	Q62702-C286
BC 308 C	Q62702-C393
BC 309 ¹⁾	Q62702-C705
BC 309 B	Q62702-C289
BC 309 C	Q62702-C323

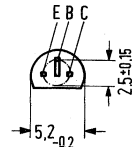
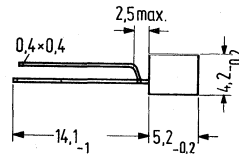

Approx. weight 0.25 g

Mounting instruction:
 Fixing hole dia 0.6

Dimensions in mm

Maximum ratings

		BC 307	BC 308	BC 309	
Collector-emitter voltage	$-V_{CES}$	50	30	25	V
Collector-emitter voltage	$-V_{CEO}$	45	25	20	V
Emitter-base voltage	$-V_{EBO}$	5	5	5	V
Collector current	$-I_C$	100	100	50	mA
Collector peak current	$-I_{CM}$	200	200	—	mA
Base current	$-I_B$	50	50	5	mA
Base peak current	$-I_{BM}$	100	100	—	mA
Junction temperature	T_j	150	150	150	°C
Storage temperature range	T_{stg}		-55 to +150		°C
Total power dissipation	P_{tot}	300	300	300	mW

Thermal resistance

Junction to ambient air	R_{thJA}	≤420	≤420	≤420	K/W
-------------------------	------------	------	------	------	-----

1) If the order does not include any exact indication of the current amplification group desired, a transistor of a current amplification group just available from stock will be delivered.

Static characteristics ($T_{amb} = 25^\circ\text{C}$)

The transistors are grouped in accordance with the DC current gain h_{FE} and marked by A, B, and C. At $-V_{CE} = 5\text{ V}$ and the collector currents indicated below the following static characteristics apply.

h_{FE} group	A	B	C
Type	BC 307, BC 308	BC 307, BC 308, BC 309	BC 308, BC 309
$-I_C$ mA	h_{FE} I_C/I_B	h_{FE} I_C/I_B	h_{FE} I_C/I_B
0.01	90	150	270
2	170 (120 to 220)	290 (180 to 460)	500 (380 to 800)
100 ³⁾	120	200 ³⁾	400 ³⁾

Type	BC 307, BC 308, BC 309				
	$-I_C$ mA	$-I_B$ mA	$-V_{BE}$ V	$-V_{CESat}$ V	$-V_{BEsat}$ V
5	0.1	—	0.57	—	—
5	2	—	0.62 (0.55–0.7)	—	—
5	100	—	0.8	—	—
5	10	—	—	0.3 (<0.6) ²⁾	—
—	10	0.5	—	0.1 (<0.2) ¹⁾	0.7 (<0.8)
—	100 ³⁾	5	—	0.2 (<0.6) ¹⁾³⁾	0.85 (<1) ³⁾

		BC 207	BC 308	BC 309	
Collector cutoff current					
($-V_{CES} = 50\text{ V}$)	$-I_{CES}$	0.2 (<15)	—	—	nA
($-V_{CES} = 30\text{ V}$)	$-I_{CES}$	—	0.2 (<15)	—	nA
($-V_{CES} = 25\text{ V}$)		—	—	0.2 (<15)	nA
Collector cutoff current					
($-V_{CES} = 20\text{ V}$; $T_{amb} = 125^\circ\text{C}$)	$-I_{CES}$	0.05 (<4)	—	—	μA
Collector cutoff current					
($-V_{CES} = 30\text{ V}$; $T_{amb} = 125^\circ\text{C}$)	$-I_{CES}$	—	0.05 (<4)	—	μA
Collector cutoff current					
($-V_{CES} = 50\text{ V}$; $T_{amb} = 125^\circ\text{C}$)	$-I_{CES}$	—	—	0.05 (<4)	μA
Emitter-base breakdown voltage ($-I_{EB} = 10\ \mu\text{A}$)	$-V_{(BR)EBO}$	>5	>5	>5	V
Collector-emitter breakdown voltage ($-I_{CE} = 2\text{ mA}$)	$-V_{(BR)CEO}$	>45	>25	>20	V

- 1) The transistor is overloaded to such an extent that the DC current gain decreases to $h_{FE} = 20$.
- 2) Collector emitter saturation voltage at $I_C = 10\text{ mA}$ for the characteristic which, at a constant base current, intersects the operating point, where $I_C = 11\text{ mA}$; $V_{CE} = 1\text{ V}$.
- 3) These values do not apply to BC 309.

Dynamic characteristics ($T_{amb} = 25^{\circ}\text{C}$)

$I_C = 2\text{ mA}$; $V_{CB} = 5\text{ V}$; $f = 1\text{ kHz}$

h_{FE} group	A	B	C	
Type	BC 307 BC 308 -	BC 307 BC 308 BC 309	- BC 308 BC 309	
h_{11e}	2.7 (1.6 to 4.5)	4.5 (3.2 to 8.5)	8.7 (6 to 15)	$k\Omega$
h_{12e}	1.5	2	3	10^{-4}
h_{21e}	220	330	600	-
h_{22e}	18 (<30)	30 (<60)	60 (<110)	μS

Dynamic characteristics ($T_{amb} = 25^{\circ}\text{C}$)

Transition frequency ($-I_C = 10\text{ mA}$;

$-V_{CE} = 5\text{ V}$; $f = 50\text{ MHz}$)

Collector-base capacitance

($-V_{CBO} = 10\text{ V}$; $f = 1\text{ MHz}$)

Noise figure

($-I_C = 0.2\text{ mA}$; $-V_{CE} = 5\text{ V}$;

$R_g = 2\text{ k}\Omega$; $f = 1\text{ kHz}$; $\Delta f = 200\text{ Hz}$)

$f = 30\text{ to }15\,000\text{ Hz}$

	BC 307	BC 308	BC 309	
f_T	200	200	200	MHz
C_{CBO}	<6	<6	<6	pF
NF	<10	<10	<4	dB
NF	-	-	2 (<4)	dB

Total perm. power dissipation versus temperature

$P_{tot} = f(T_{amb})$

BC 307, BC 308, BC 309

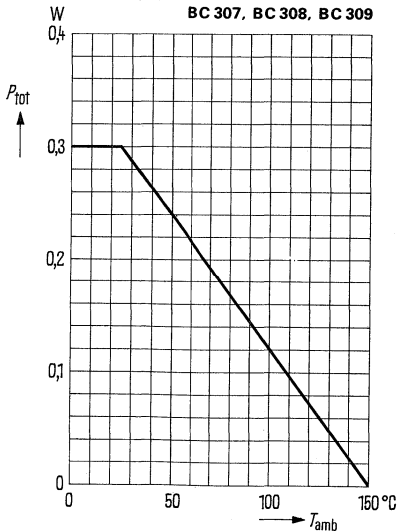

Permissible pulse load

$r_{thJA} = f(t)$ v = parameter

BC 307, BC 308, BC 309

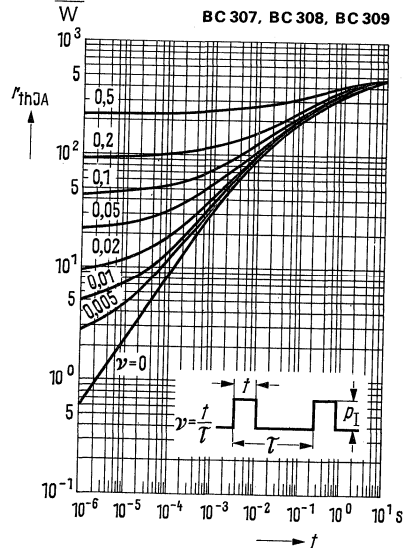

DC current gain $h_{FE} = f(I_C)$
 $-V_{CE} = 5 \text{ V}$

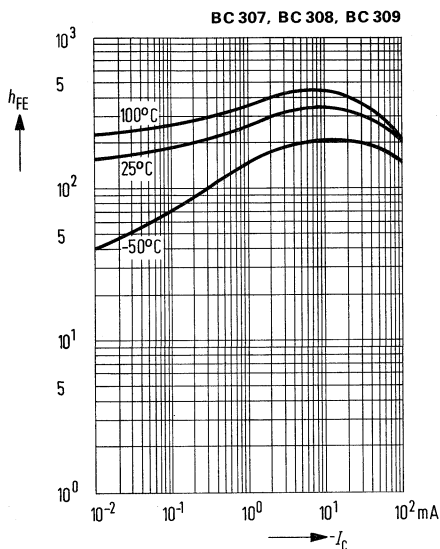

Output characteristics $I_C = f(V_{CE})$
 $I_B = \text{parameter}$

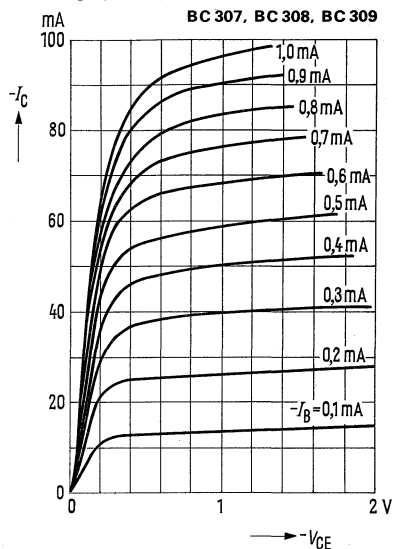

Collector current $I_C = f(V_{BE})$
 $-V_{CE} = 5 \text{ V}$

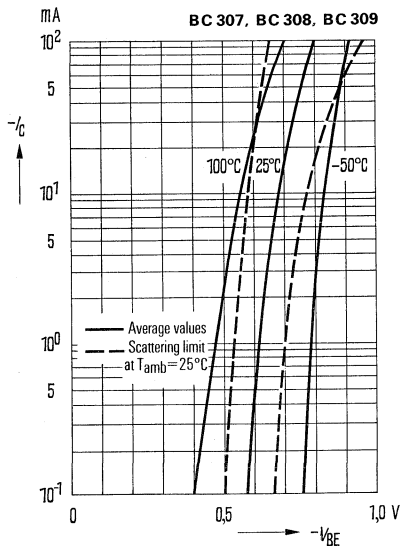

Output characteristics $I_C = f(V_{CE})$
 $I_B = \text{parameter}$

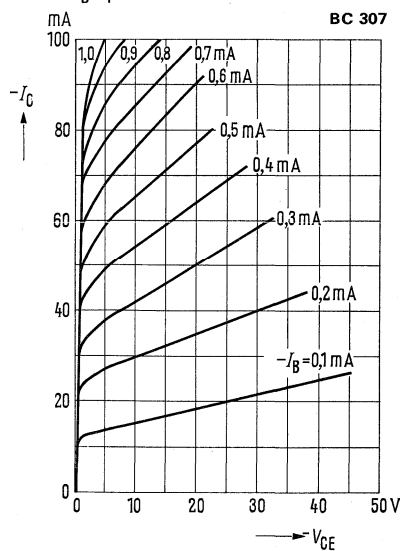

Output characteristics $I_C = f(V_{CE})$
 $I_B = \text{parameter}$

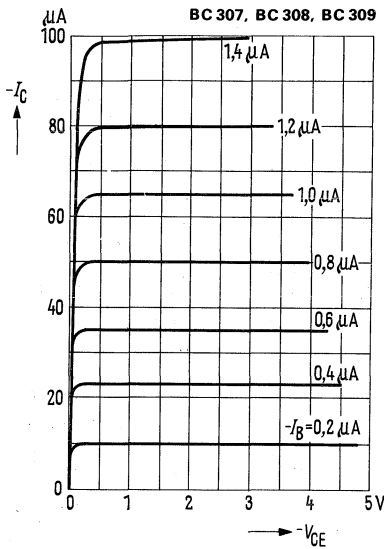

Output characteristics $I_C = f(V_{CE})$
 $V_{BE} = \text{parameter}$

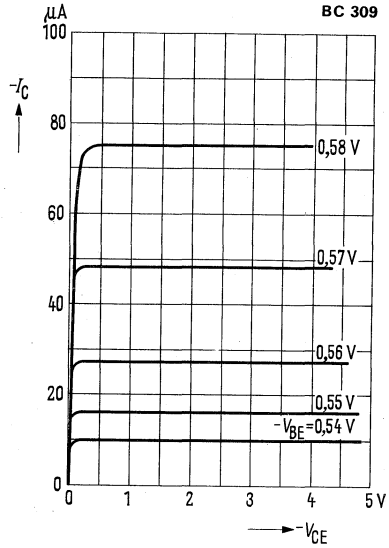

Collector-emitter saturation voltage
 $V_{CEsat} = f(I_C); h_{FE} = 20;$
 $T_{amb} = \text{parameter}$

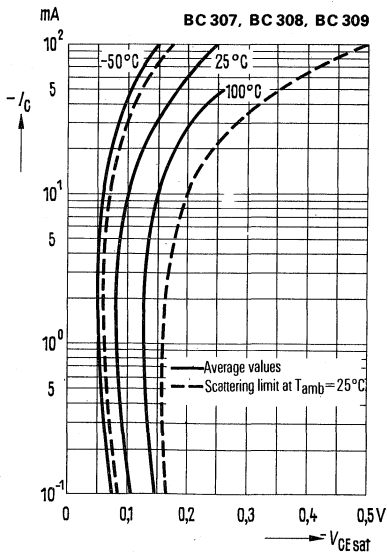

Base-emitter saturation voltage
 $V_{BEsat} = f(I_C); h_{FE} = 20;$
 $T_{amb} = \text{parameter}$

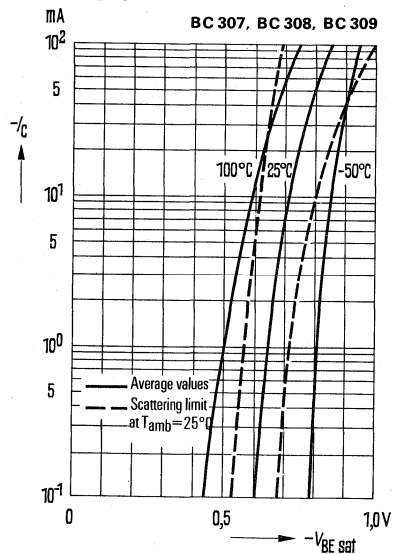

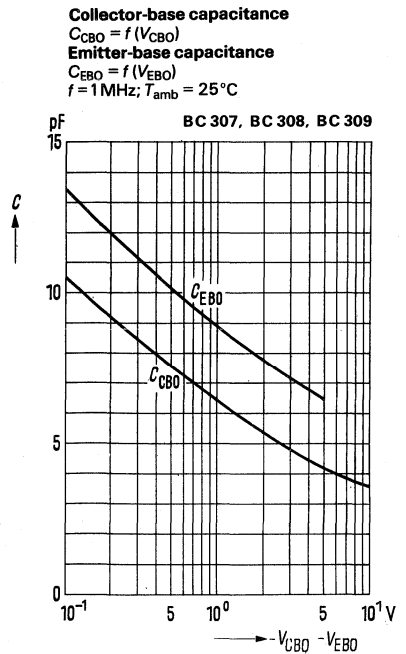
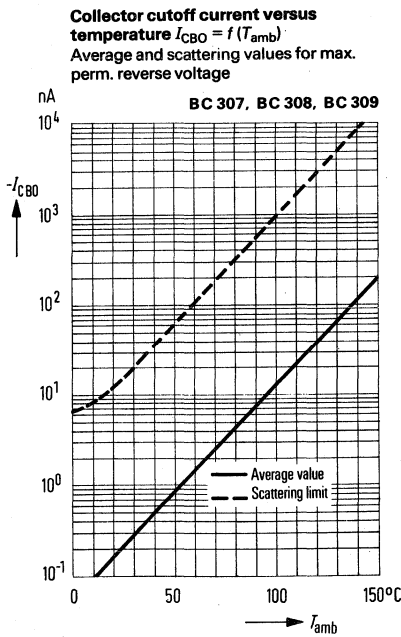
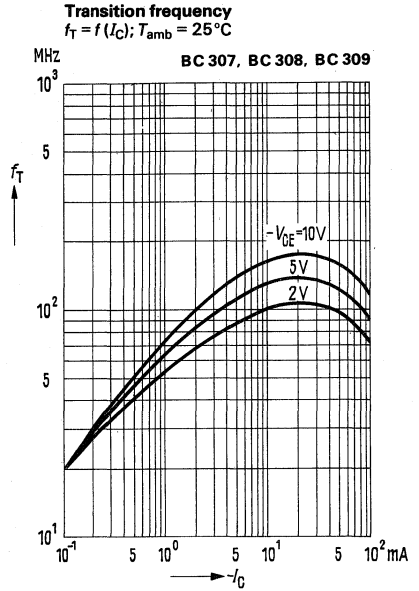
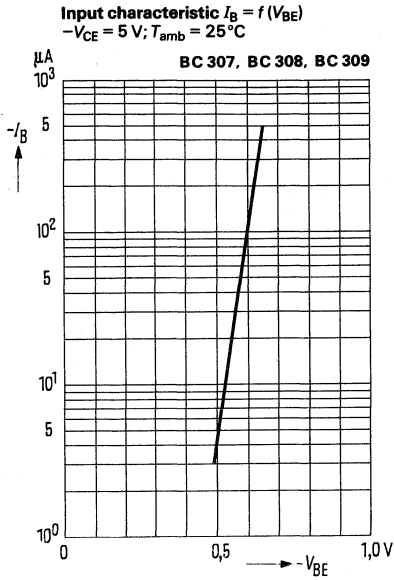

BC 307
BC 308
BC 309

***h*-parameter versus collector current**

$-V_{CE} = 5\text{ V}; T_{amb} = 25^\circ\text{C}$

$$H_o = \frac{h_o(I_C)}{h_e(I_C = 2\text{ mA})} = f(I_C)$$

BC 307, BC 308, BC 309

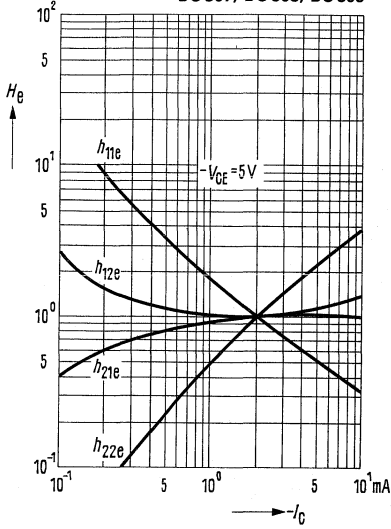

***h*-parameter versus collector-emitter voltage**

$-I_C = 2\text{ mA}; T_{amb} = 25^\circ\text{C}$

$$H_o = \frac{h_o(V_{CE})}{h_e(V_{CE} = 5\text{ V})} = f(V_{CE})$$

BC 307, BC 308, BC 309

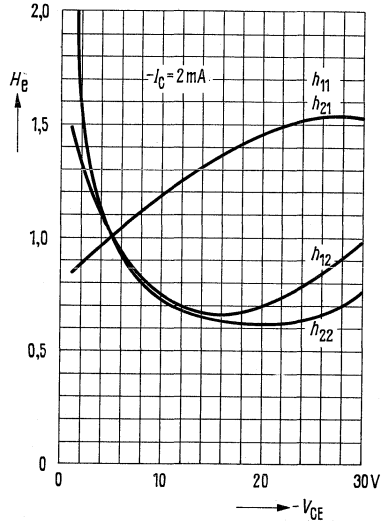

Noise figure $NF = f(I_C)$

$-V_{CE} = 5\text{ V}; f = 120\text{ Hz}; T_{amb} = 25^\circ\text{C}$

BC 309

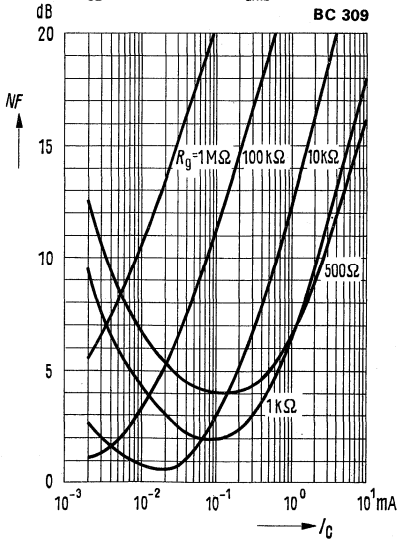

Noise figure $NF = f(I_C)$

$-V_{CE} = 5\text{ V}; f = 1\text{ kHz}; T_{amb} = 25^\circ\text{C}$

BC 309

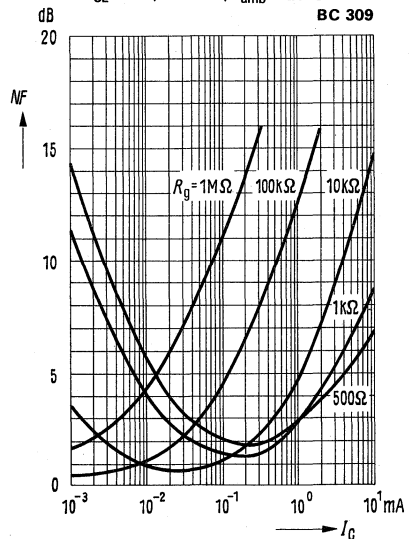

Noise figure $NF = f(f)$
 $R_G = 2 \text{ k}\Omega$; $-V_{CE} = 5 \text{ V}$; $-I_C = 0.2 \text{ mA}$
 $T_{amb} = 25^\circ\text{C}$

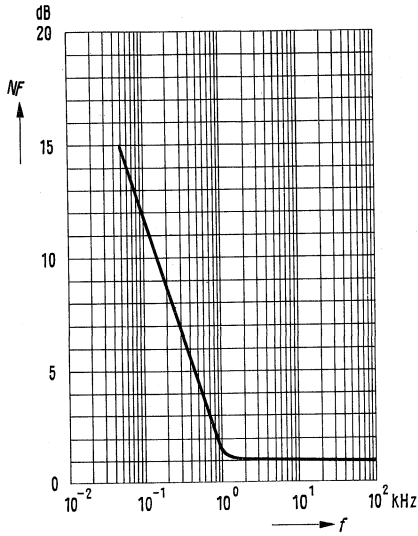

Noise figure $NF = f(V_{CE})$
 $-I_C = 0.2 \text{ mA}$; $R_G = 2 \text{ k}\Omega$; $f = 1 \text{ kHz}$
 $T_{amb} = 25^\circ\text{C}$

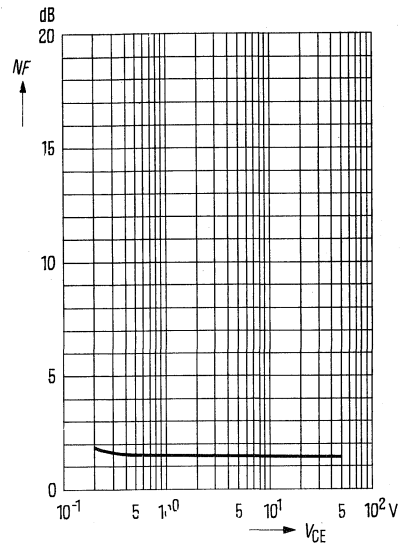

Noise figure $NF = f(I_C)$
 $-V_{CE} = 5 \text{ V}$; $f = 10 \text{ kHz}$; $T_{amb} = 25^\circ\text{C}$

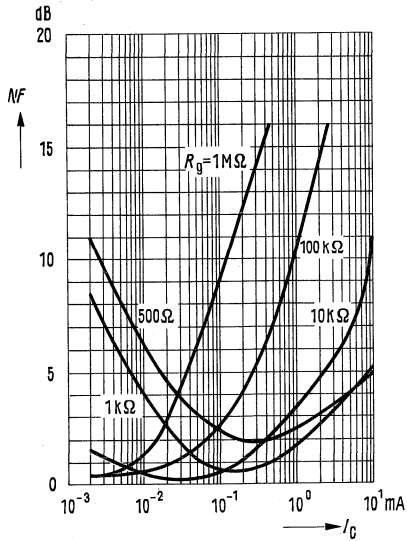

BC 327 and BC 328 are epitaxial PNP silicon planar transistors in TO 92 plastic package (10 A 3 DIN 41868). The transistors are suitable as complementary transistors to BC 337 and BC 338.

Type	Ordering code
BC 327 ¹⁾	Q62702-C311
BC 327-16	Q62702-C311-V3
BC 327-25	Q62702-C311-V4
BC 327-40	Q62702-C311-V2
BC 328 ¹⁾	Q62702-C312
BC 328-16	Q62702-C312-V3
BC 328-25	Q62702-C312-V4
BC 328-40	Q62702-C312-V2
BC327/BC337 paired	Q62702-C366-S1
BC328/BC338 paired	Q62702-C367-S1

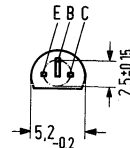
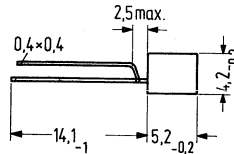

Mounting instruction:
Fixing hole dia 0.6
Approx. weight 0.25 g

Dimensions in mm

Maximum ratings

		BC 327	BC 328	
Collector-emitter voltage	$-V_{CES}$	50	30	V
Collector-emitter voltage	$-V_{CEO}$	45	25	V
Emitter-base voltage	$-V_{EBO}$	5	5	V
Collector current	$-I_C$	800	800	mA
Collector peak current	$-I_{CM}$	1	1	A
Base current	$-I_B$	100	100	mA
Junction temperature	T_j	150	150	°C
Storage temperature range	T_{stg}	-55 to +150		°C
Total power dissipation $T_{amb} \leq 25^\circ\text{C}$	P_{tot}	625	625	mW

Thermal resistance

Junction to ambient air	R_{thJA}	≤ 200	≤ 200	K/W
Junction to case	R_{thJC}	≤ 90	≤ 90	K/W

1) If the order does not include any exact indication of the current amplification group desired, a transistor of a current amplification group just available from stock will be delivered.

Static characteristics ($T_{amb} = 25^{\circ}\text{C}$)

	BC 327	BC 328	
Collector cutoff current ($-V_{CE} = 25\text{ V}$)	$-I_{CES}$	–	2 (<100) nA
Collector cutoff current ($-V_{CE} = 25\text{ V}; T_{amb} = 125^{\circ}\text{C}$)	$-I_{CES}$	–	<10 μA
Collector cutoff current ($-V_{CE} = 45\text{ V}$)	$-I_{CES}$	2 (<100)	– nA
Collector cutoff current ($-V_{CE} = 45\text{ V}; T_{amb} = 125^{\circ}\text{C}$)	$-I_{CES}$	<10	– μA
Emitter-base breakdown voltage ($-I_{EB} = 100\text{ }\mu\text{A}$)	$-V_{(BR)EBO}$	>5	>5 V
Collector-emitter breakdown voltage ($-I_{CE} = 100\text{ }\mu\text{A}$)	$-V_{(BR)CES}$	>50	>30 V
Collector-emitter breakdown voltage ($-I_{CE} = 10\text{ mA}$)	$-V_{(BR)CEO}$	>45	>20 V
Collector emitter saturation voltage ($-I_C = 500\text{ mA}; I_B = 50\text{ mA}$)	$-V_{CEsat}$	<0.7 ¹⁾	<0.7 ¹⁾ V

The transistors are grouped at $I_C = 100\text{ mA}$ in accordance with the DC current gain h_{FE} and marked by figures of the German DIN standard. At $-V_{CE} = 1\text{ V}$ and the collector currents tabulated below the following static characteristics apply:

h_{FE} group		16	25	40
Type		BC 327, BC 328	BC 327, BC 328	BC 327, BC 328
$-I_C$ (mA)	$-V_{BE}$ (V)	h_{FE} I_C/I_B	h_{FE} I_C/I_B	h_{FE} I_C/I_B
100	–	160 (100 to 250)	250 (160 to 400)	400 (250 to 630)
300	<1.2	130 (>60)	200 (>100)	320 (>170)

Condition for matching pairs:

$$(I_C = 100\text{ mA}; V_{CE} = 1\text{ V}) \frac{h_{FE1}}{h_{FE2}} \leq 1.41$$

Dynamic characteristics ($T_{amb} = 25^{\circ}\text{C}$)

	BC 327	BC 328	
Transition frequency ($-I_C = 10\text{ mA};$ $-V_{CE} = 5\text{ V}; f = 50\text{ MHz}$)	f_T	100	100 MHz
Collector-base capacitance ($-V_{CB} = 10\text{ V}; f = 1\text{ MHz}$)	C_{CBO}	12	12 pF

1) The transistor is overloaded to such an extent that the DC current gain decreases to $h_{FE} = 10$.

**Total perm. power dissipation
versus temperature**
 $P_{tot} = f(T_{amb})$

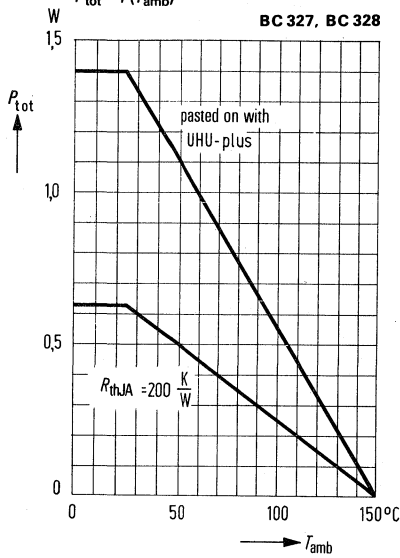

Permissible pulse load
 $r_{thJA} = f(t) \nu = \text{parameter}$

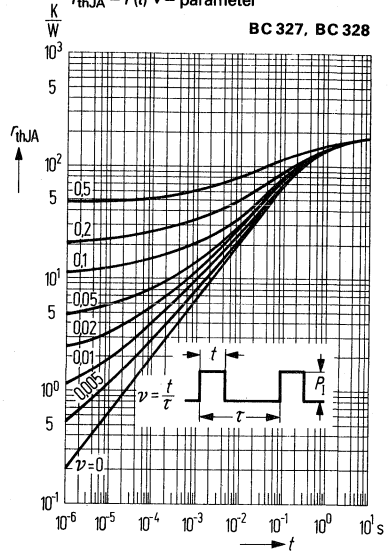

Collector current $I_C = f(V_{BE})$
BC 327, BC 328

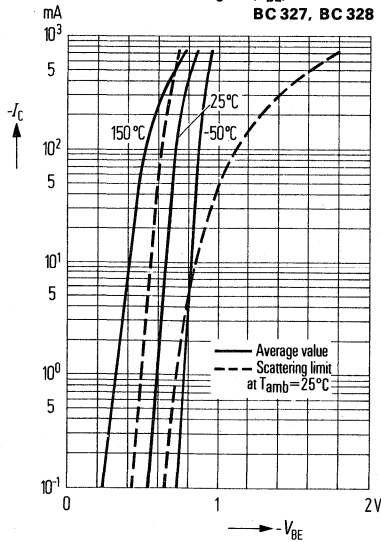

**Collector-cutoff current versus
temperature $I_{CES} = f(T_{amb})$**

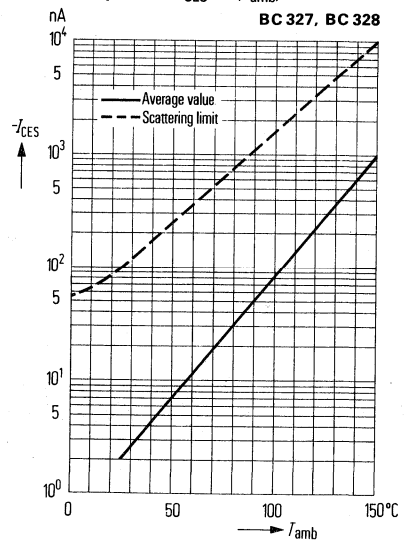

DC current gain $h_{FE} = f(I_C)$;
 $-V_{CE} = 1\text{ V}; T_{amb} = \text{parameter}$

BC 327, BC 328

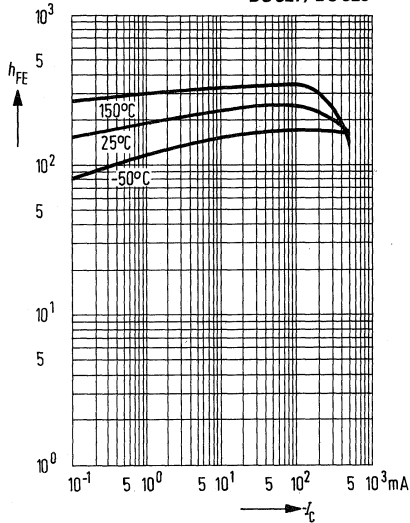

Transition frequency $f_T = f(I_C)$
 $f = 20\text{ MHz}; T_{amb} = 25^\circ\text{C}$

BC 327, BC 328

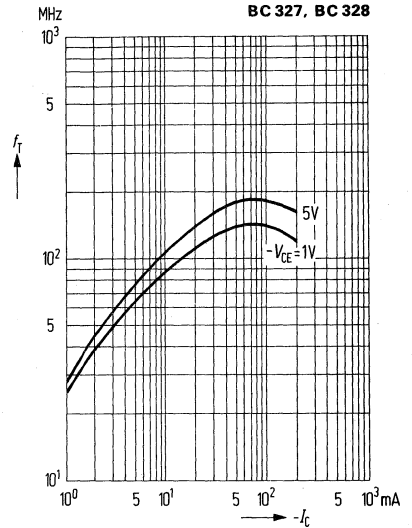

Collector-emitter saturation voltage

$V_{CEsat} = f(I_C); h_{FE} = 10;$
 $T_{amb} = \text{parameter}$

BC 327, BC 328

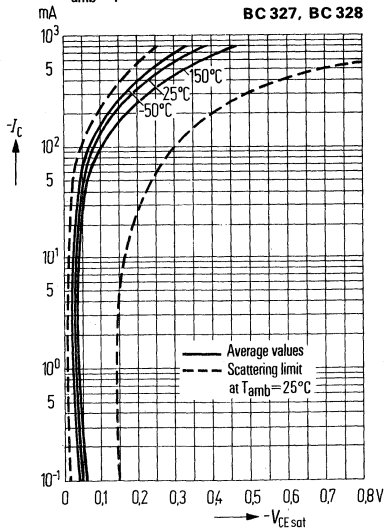

Base-emitter saturation voltage

$V_{BEsat} = f(I_C); h_{FE} = 10;$
 $T_{amb} = \text{parameter}$

BC 327, BC 328

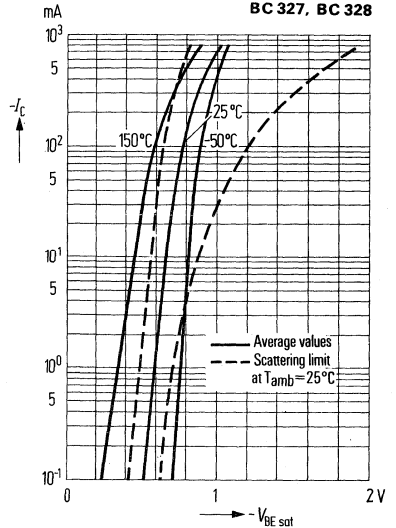

BC 337 and BC 338 are epitaxial NPN silicon planar transistors in TO 92 plastic packages (10 A 3 DIN 41868). The transistors are suitable for use as complementary transistors to BC 327 and BC 328.

Type	Ordering code
BC 337 ¹⁾	Q62702-C313
BC 337-16	Q62702-C313-V3
BC 337-25	Q62702-C313-V1
BC 337-40	Q62702-C313-V2
BC 338 ¹⁾	Q62702-C314
BC 338-16	Q62702-C314-V1
BC 338-25	Q62702-C314-V2
BC 338-40	Q62702-C314-V3
BC 337/BC 327 paired	Q62702-C366-S1
BC 338/BC 328 paired	Q62702-C367-S1

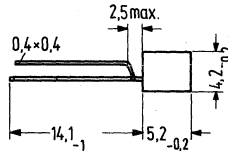

Mounting instruction:
Fixing hole dia 0.6
Approx. weight 0.25 g

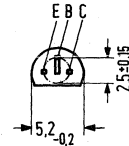

Dimensions in mm

Maximum ratings

		BC 337	BC 338	
Collector-emitter voltage	V_{CES}	50	30	V
Collector-emitter voltage	V_{CEO}	45	25	V
Emitter-base voltage	V_{EBO}	5	5	V
Collector current	I_C	800	800	mA
Collector peak current	I_{CM}	1	1	A
Base current	I_B	100	100	mA
Junction temperature	T_j	150	150	°C
Storage temperature range	T_{stg}	-55 to +150		°C
Total power dissipation ($T_{amb} \leq 25^\circ\text{C}$)	P_{tot}	625	625	mW

Thermal resistance

Junction to ambient air	R_{thJA}	≤ 200	≤ 200	K/W
Junction to case	R_{thJC}	≤ 90	≤ 90	K/W

1) If the order does not include any exact indication of the current amplification group desired, a transistor of a current amplification group just available from stock will be delivered.

Static characteristics ($T_{amb} = 25^\circ\text{C}$)

Collector cutoff current

($V_{CE} = 25\text{ V}$)

Collector cutoff current

($V_{CE} = 25\text{ V}; T_{amb} = 125^\circ\text{C}$)

Collector cutoff current

($V_{CE} = 45\text{ V}$)

Collector cutoff current

($V_{CE} = 45\text{ V}; T_{amb} = 125^\circ\text{C}$)

Emitter-base breakdown voltage

($I_{EB} = 100\ \mu\text{A}$)

Collector-emitter breakdown voltage

($I_{CE} = 100\ \mu\text{A}$)

Collector-emitter breakdown voltage

($I_{CE} = 10\text{ mA}$)

Collector emitter saturation voltage

($I_C = 500\text{ mA}; I_B = 50\text{ mA}$)

	BC 337	BC 338	
I_{CES}	–	2 (<100)	nA
I_{CES}	–	<10	μA
I_{CES}	2 (<100)	–	nA
I_{CES}	<10	–	μA
$V_{(BR)EBO}$	>5	>5	V
$V_{(BR)CES}$	>50	>30	V
$V_{(BR)CEO}$	>45	>20	V
V_{CEsat}	<0.7 ¹⁾	<0.7 ¹⁾	V

The transistors are grouped at $I_C = 100\text{ mA}$ in accordance with the DC current gain h_{FE} and marked by figures of the German DIN standard.

At $V_{CE} = 1\text{ V}$ and the collector current indicated below, the following static characteristics apply.

h_{FE} group		16	25	40
Type		BC 337, BC 338	BC 337, BC 338	BC 337, BC 338
I_C (mA)	V_{BE} (V)	h_{FE} I_C/I_B	h_{FE} I_C/I_B	h_{FE} I_C/I_B
100	–	160 (100 to 250)	250 (160 to 400)	400 (250 to 630)
300	<1.2	130 (>60)	200 (>100)	320 (>170)

Condition for matching pairs:

$$(I_C = 100\text{ mA}; V_{CE} = 1\text{ V}) \frac{h_{FE1}}{h_{FE2}} \leq 1.41$$

Dynamic characteristics ($T_{amb} = 25^\circ\text{C}$)

Transition frequency ($I_C = 10\text{ mA};$

$V_{CE} = 5\text{ V}; f = 50\text{ MHz}$)

Collector-base capacitance

($V_{CB} = 10\text{ V}; f = 1\text{ MHz}$)

	BC 337	BC 338	
f_T	100	100	MHz
C_{CBO}	12	12	pF

1) The transistor is overloaded to such an extent that the DC current gain decreases to $h_{FE} = 10$.

Total perm. power dissipation versus temperature
 $P_{tot} = f(T_{amb})$

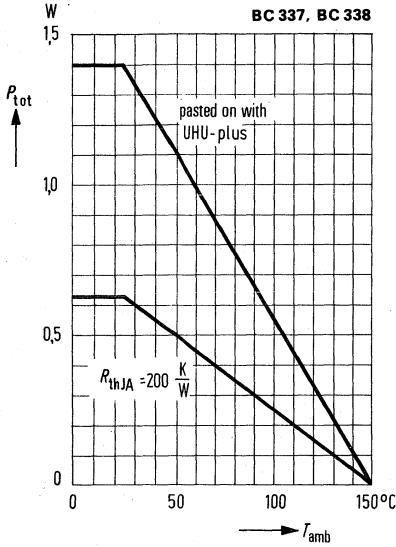

Permissible pulse load
 $r_{thJA} = f(t)$ v = parameter

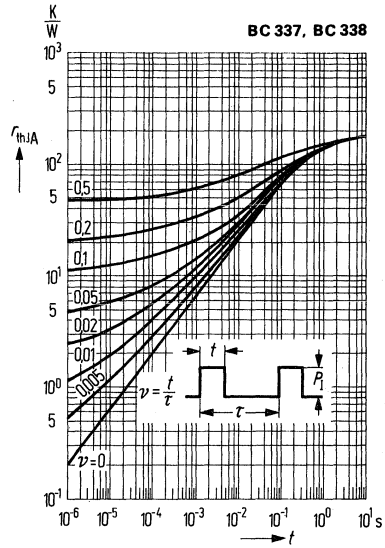

Collector current $I_C = f(V_{BE})$

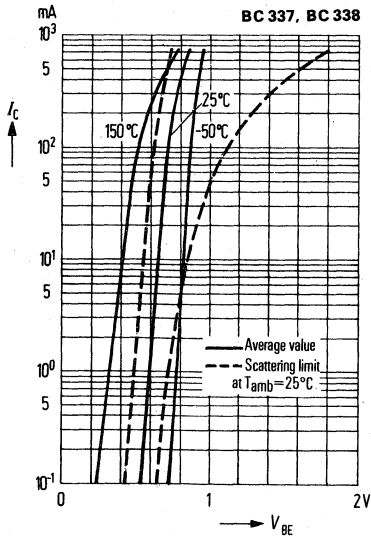

Collector cutoff current versus temperature
 $I_{CES} = f(T_{amb})$

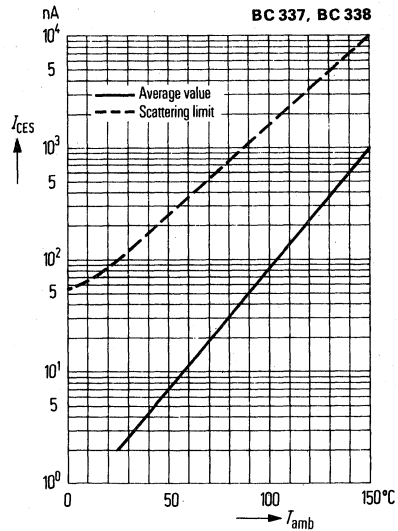

DC current gain $h_{FE} = f(I_C)$
 $V_{CE} = 1V$
 $T_{amb} = \text{parameter}$

BC 337, BC 338

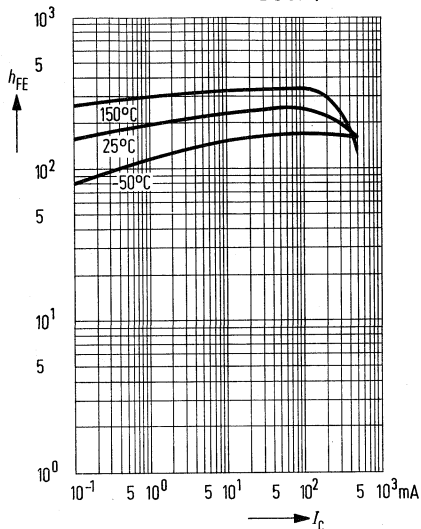

Transition frequency $f_T = f(I_C)$
 $f = 20 \text{ MHz}; T_{amb} = 25^\circ\text{C}$

BC 337, BC 338

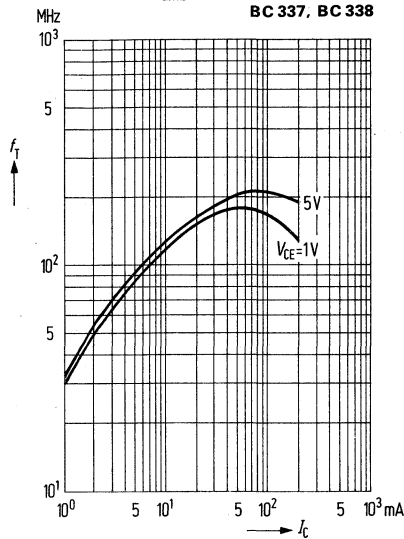

Collector-emitter saturation voltage

$V_{CEsat} = f(I_C); h_{FE} = 10;$
 $T_{amb} = \text{parameter}$

BC 337, BC 338

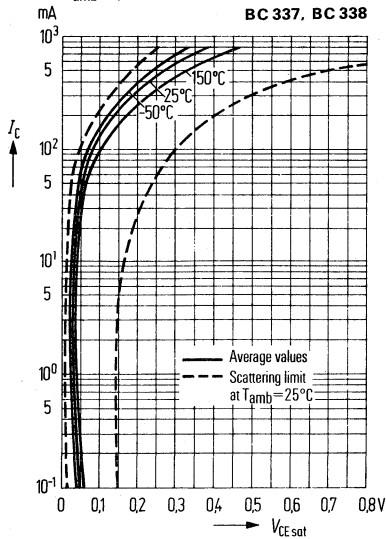

Base-emitter saturation voltage

$V_{BEsat} = f(I_C); h_{FE} = 10;$
 $T_{amb} = \text{parameter}$

BC 337, BC 338

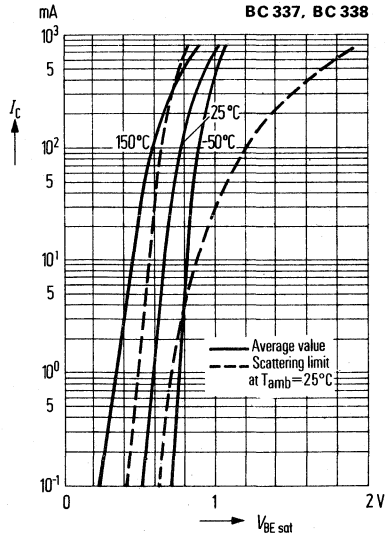

BC 368 is an epitaxial NPN silicon planar transistor in TO 92 plastic package (10 A 3 DIN 41 868). It is intended for use in output stages of low performance and as complementary transistor to BC 369.

Type	Ordering code
BC 368	Q62702-C747
BC 368/BC 369 paired	Q62702-C788

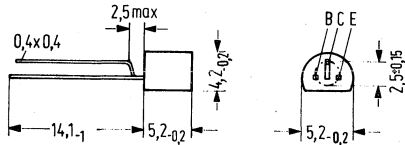

Mounting instruction:
 Fixing hole dia 0.6
 Approx. weight 0.25 g

Dimensions in mm

Maximum ratings

Collector-emitter voltage	V_{CES}	25	V
Collector-emitter voltage	V_{CEO}	20	V
Emitter-base voltage	V_{EBO}	5	V
Collector current	I_C	1	A
Collector peak current	I_{CM}	2	A
Base current	I_B	100	mA
Base peak current	I_{BM}	200	mA
Junction temperature	T_j	150	°C
Storage temperature range	T_{stg}	-55 to +150	°C
Total power dissipation ($T_{amb} = 25^\circ\text{C}$)	P_{tot}	0.8 (1)	W

Thermal resistance

Junction to ambient air ¹⁾	R_{thJA}	≤ 156	K/W
Junction to case	R_{thJC}	≤ 60	K/W

1) If the transistors with max. 4 mm lead length are fixed on PCBs with a min. 10 mm x 10 mm large copper area for the collector terminal, $R_{thJA} = 125 \text{ K/W}$ and thus $P_{tot \text{ max}} (T_{amb} = 25^\circ\text{C}) = 1 \text{ W}$

Static characteristics ($T_{amb} = 25^{\circ}\text{C}$)

Collector-emitter saturation voltage

($I_C = 1\text{ A}$; $I_B = 100\text{ mA}$)

Collector cutoff current

($V_{CB} = 25\text{ V}$)

Collector cutoff current

($V_{CB} = 25\text{ V}$; $T_j = 150^{\circ}\text{C}$)

Emitter cutoff current

($V_{EB} = 5\text{ V}$)

Base-emitter voltage

($V_{CE} = 10\text{ V}$; $I_C = 5\text{ mA}$)

($V_{CE} = 1\text{ V}$; $I_C = 1\text{ A}$)

DC current gain

$V_{CE} = 10\text{ V}$; $I_C = 5\text{ mA}$

$V_{CE} = 1\text{ V}$; $I_C = 0.5\text{ A}$

$V_{CE} = 1\text{ V}$; $I_C = 1\text{ A}$

V_{CEsat}	≤ 0.5	V
I_{CBO}	≤ 10	μA
I_{CBO}	≤ 1	mA
I_{EBO}	≤ 10	μA
V_{BE}	0.6	V
V_{BE}	≤ 1	V
h_{FE}	> 50	-
h_{FE}	85 to 375	-
h_{FE}	> 60	-

Dynamic characteristics ($T_{amb} = 25^{\circ}\text{C}$)

Transition frequency

($V_{CE} = 5\text{ V}$; $I_C = 10\text{ mA}$)

f_T	65	MHz
-------	----	-----

Total perm. power dissipation versus temperature

$P_{tot} = f(T_{amb})$

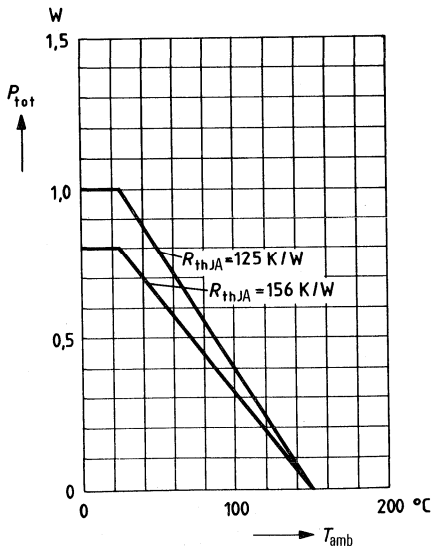

Collector cutoff current versus temperature $I_{CBO} = f(T_{amb})$

$V_{CB} = V_{CB\text{ max.}}$

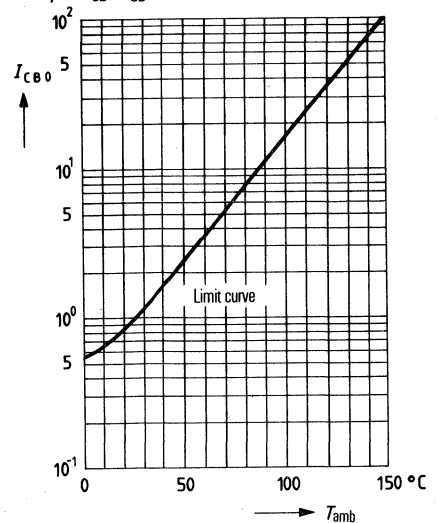

Collector current $I_C = f(V_{BE})$
 $V_{CE} = 1\text{ V}; T_{amb} = 25^\circ\text{C}$

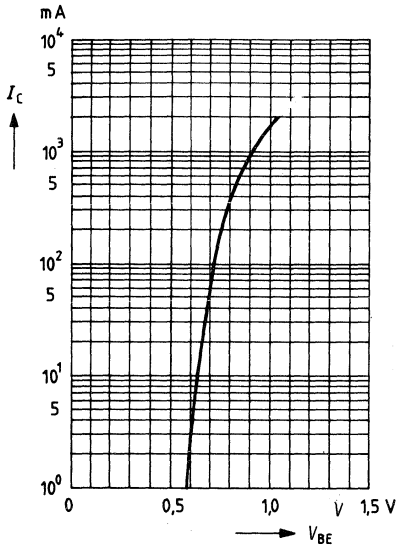

Collector-emitter saturation voltage $V_{CEsat} = f(I_C)$
 $V_{CEsat} = f(I_C);$
 $h_{FE} = 10; T_{amb} = 25^\circ\text{C}$

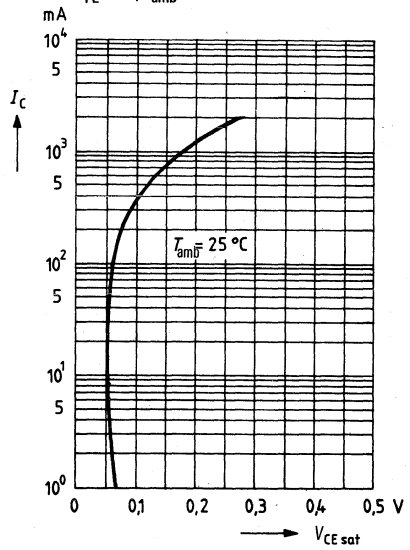

DC current gain $h_{FE} = f(I_C)$
 $V_{CE} = 1\text{ V}; T_{amb} = \text{parameter}$

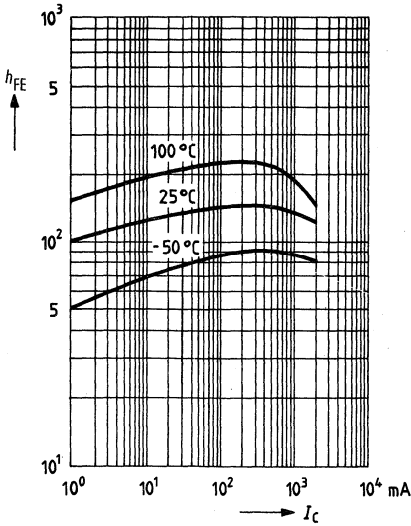

BC 369 is an epitaxial PNP silicon planar transistor in TO 92 plastic package (10 A 3 DIN 41 868). It is intended for use in output stages of low performance and as complementary transistor to BC 368.

Type	Ordering code
BC 369	Q62702-C748
BC 369/BC 368 paired	Q62702-C788

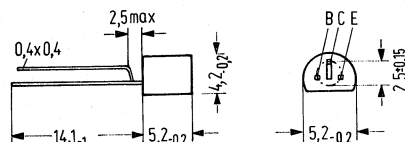

Mounting instruction:
Fixing hole dia 0.6
Approx. weight 0.25 g

Dimensions in mm

Maximum ratings

Collector-emitter voltage	$-V_{CES}$	25	V
Collector-emitter voltage	$-V_{CEO}$	20	V
Emitter-base voltage	$-V_{EBO}$	5	V
Collector current	$-I_C$	1	A
Collector peak current	$-I_{CM}$	2	A
Base current	$-I_B$	100	mA
Base peak current	$-I_{BM}$	200	mA
Junction temperature	T_j	150	°C
Storage temperature range	T_{stg}	-55 to +150	°C
Total power dissipation ¹⁾ ($T_{amb} = 25\text{ °C}$)	P_{tot}	0.8 (1)	W

Thermal resistance

Junction to ambient air ¹⁾	R_{thJA}	≤ 156	K/W
Junction to case	R_{thJC}	≤ 60	K/W

1) If the transistors with max. 4 mm lead length are fixed on PCBs with a min. 10 mm x 10 mm large copper area for the collector terminal, $R_{thJA} = 125\text{ K/W}$ and thus $P_{tot\ max} (T_{amb} = 25\text{ °C}) = 1\text{ W}$.

Static characteristics ($T_{amb} = 25^{\circ}\text{C}$)

Collector-emitter saturation voltage

($-I_C = 1\text{ A}$; $-I_B = 100\text{ mA}$)

Collector cutoff current

($-V_{CB} = 25\text{ V}$)

Collector cutoff current

($-V_{CB} = 25\text{ V}$; $T_j = 150^{\circ}\text{C}$)

Emitter cutoff current

($-V_{EB} = 5\text{ V}$)

Base-emitter voltage

($-V_{CE} = 10\text{ V}$; $-I_C = 5\text{ mA}$)

($-V_{CE} = 1\text{ V}$; $-I_C = 1\text{ A}$)

DC current gain

$-V_{CE} = 10\text{ V}$; $-I_C = 5\text{ mA}$

$-V_{CE} = 1\text{ V}$; $-I_C = 0.5\text{ A}$

$-V_{CE} = 1\text{ V}$; $-I_C = 1\text{ A}$

$-V_{CEsat}$	≤ 0.5	V
$-I_{CBO}$	≤ 10	μA
$-I_{CBO}$	≤ 1	mA
$-I_{EBO}$	≤ 10	μA
$-V_{BE}$	0.6	V
$-V_{BE}$	≤ 1	V
h_{FE}	> 50	-
h_{FE}	85 to 375	-
h_{FE}	> 60	-

Dynamic characteristics ($T_{amb} = 25^{\circ}\text{C}$)

Transition frequency

($V_{CE} = 5\text{ V}$; $I_C = 10\text{ mA}$)

f_T	65	MHz
-------	----	-----

Total perm. power dissipation versus temperature

$P_{tot} = f(T_{amb})$

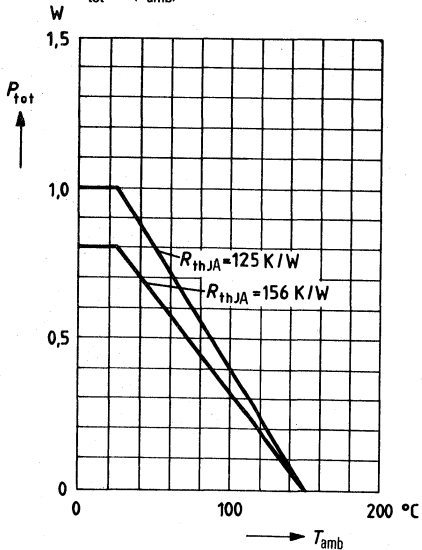

Collector cutoff current versus temperature $I_{CBO} = f(T_{amb})$

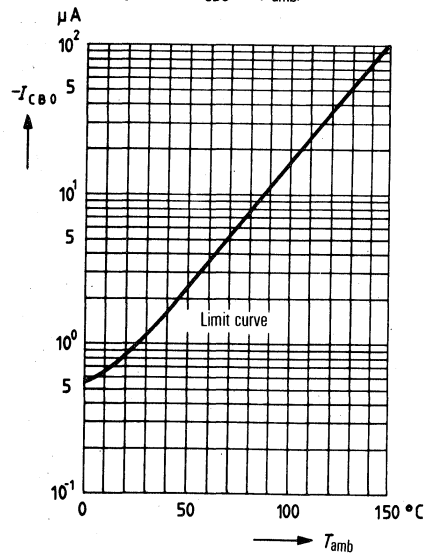

Collector current $I_C = f(V_{BE})$
 $-V_{CE} = 1\text{ V}; T_{amb} = 25^\circ\text{C}$

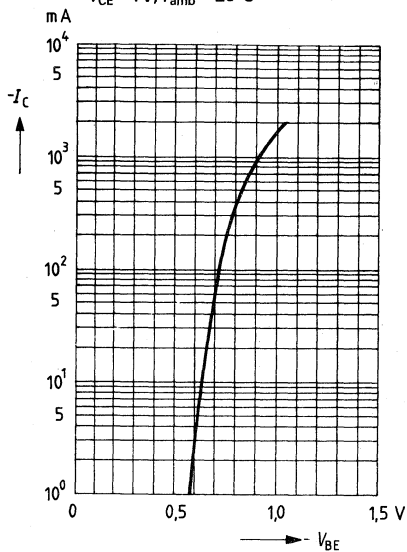

Collector-emitter saturation voltage
 $V_{CEsat} = f(I_C)$
 $h_{FE} = 10; T_{amb} = 25^\circ\text{C}$

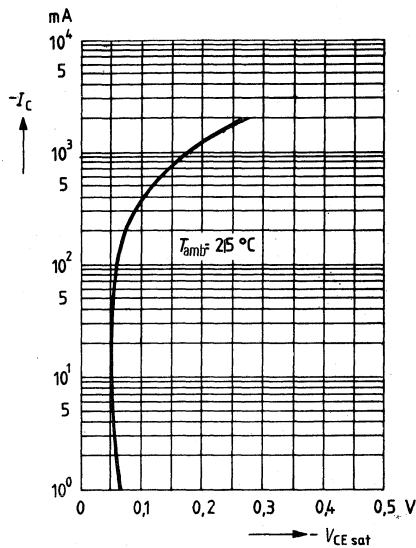

DC current gain $h_{FE} = f(I_C)$
 $-V_{CE} = 1\text{ V}; T_{amb} = \text{parameter}$

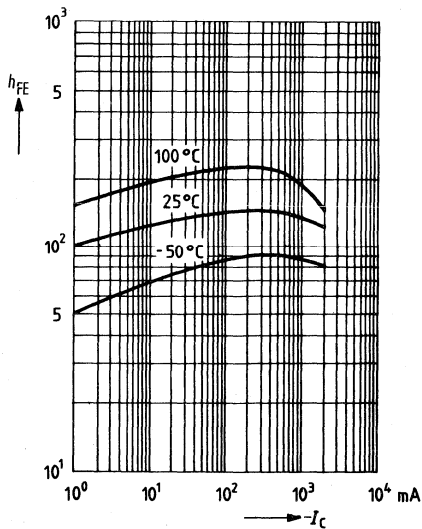

BC 413 and BC 414 are epitaxial NPN silicon planar transistors in TO 92 plastic packages (10 A 3 DIN 41868). They are intended for use in low-noise AF input stages and as complementary transistors to BC 415 and BC 416.

Type	Ordering code
BC 413 ¹⁾	Q62702-C375
BC 413 B	Q62702-C375-V1
BC 413 C	Q62702-C375-V2
BC 414 ¹⁾	Q62702-C376
BC 414 B	Q62702-C376-V1
BC 414 C	Q62702-C376-V2

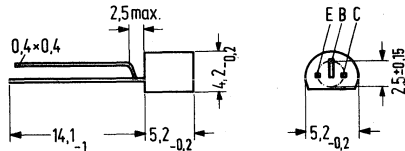

Mounting instruction: Fixing hole dia 0.6
Approx. weight 0.25 g
Dimensions in mm

Maximum ratings

		BC 413	BC 414	
Collector-emitter voltage	V_{CE0}	30	45	V
Collector-base voltage	V_{CBO}	45	50	V
Emitter-base voltage	V_{EBO}	5	5	V
Collector current	I_C	100	100	mA
Base current	I_B	20	20	mA
Junction temperature	T_j	150	150	°C
Storage temperature range	T_{stg}	-65 to +150		°C
Total power dissipation ($T_{amb} = 25^\circ\text{C}$)	P_{tot}	300	300	mW

Thermal resistance

Junction to ambient air	R_{thJA}	420	420	K/W
-------------------------	------------	-----	-----	-----

Static characteristics ($T_{amb} = 25^\circ\text{C}$)

The transistors are grouped according to the DC current gain h_{FE} and marked by B and C. At $V_{CE} = 5\text{ V}$ and the collector currents tabulated below the following static characteristics apply.

h_{FE} group	B	C
Type	BC 413, BC 414	BC 413, BC 414
I_C (mA)	h_{FE} I_C/I_B	h_{FE} I_C/I_B
0.01	150 (> 100)	270 (> 100)
2	290 (180 to 460)	500 (380 to 800)

1) If the order does not include any exact indication of the current amplification group desired, a transistor of a current amplification group just available from stock will be delivered.

Type	BC 413, BC 414				
V_{CE} (V)	I_C (mA)	I_B (mA)	V_{BE} (V)	V_{CEsat} (V)	V_{BEsat} (V)
5	0.01	—	0.52	—	—
5	0.1	—	0.55	—	—
—	10	0.5	—	0.075 (<0.25)	—
—	100	5	—	0.25 (<0.6)	0.9
5	2	—	0.62(0.55to0.75)	—	—
1	10	—	—	0.3 (<0.6) ¹⁾	—

Static characteristics ($T_{amb} = 25^\circ\text{C}$)

Collector cutoff current

($V_{CB} = 30\text{ V}$)

Collector cutoff current

($V_{CB} = 30\text{ V}; T_{amb} = 150^\circ\text{C}$)

Emitter cutoff current

($V_{EB} = 4\text{ V}$)

Collector-emitter breakdown voltage

($I_C = 10\text{ mA}$)

Collector-base breakdown voltage

($I_C = 10\text{ }\mu\text{A}$)

Emitter-base breakdown voltage

($I_C = 10\text{ }\mu\text{A}$)

	BC 413	BC 414	
I_{CBO}	< 15	< 15	nA
I_{CBO}	< 5	< 5	μA
I_{EBO}	< 15	< 15	nA
$V_{(BR)CEO}$	> 30	> 45	V
$V_{(BR)CBO}$	> 45	> 50	V
$V_{(BR)EBO}$	> 5	> 5	V

Dynamic characteristics ($T_{amb} = 25^\circ\text{C}$)

Transition frequency ($I_C = 10\text{ mA};$

$V_{CE} = 5\text{ V}; f = 100\text{ MHz}$)

Collector-base capacitance

($V_{CB} = 10\text{ V}; I_E = 0; f = 1\text{ MHz}$)

Noise figure ($I_C = 0.2\text{ mA};$

$V_{CE} = 5\text{ V}; f = 30\text{ Hz to } 15\text{ kHz}$)

Equivalent, base referred noise voltage²⁾

($I_C = 0.2\text{ mA}; V_{CE} = 5\text{ V}; R_g = 2\text{ k}\Omega;$

$f = 10\text{ to } 50\text{ Hz}$)

f_T	250	250	MHz
C_{CBO}	2.5	2.5	pF
NF	< 2.5	< 2.5	dB
E_n	< 0.135	< 0.135	μV

Test circuit for noise voltage measurement

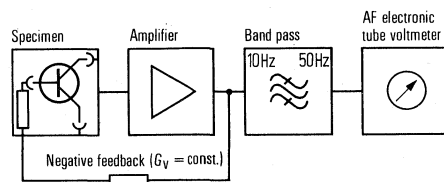

- 1) For the characteristic which passes through the point $I_C = 11\text{ mA}; V_{CE} = 1\text{ V}$ at constant base current.
- 2) Test circuit for noise voltage measurement.

Dynamic characteristics ($T_{amb} = 25^{\circ}\text{C}$)

$I_C = 2 \text{ mA}$; $V_{CE} = 5 \text{ V}$; $f = 1 \text{ kHz}$

Type	BC 413, BC 414	BC 413, BC 414	
h_{FE} group	B	C	
h_{11e}	4.5 (3.2 to 8.5)	8.7 (6 to 15)	$k\Omega$
h_{12e}	2	3	10^{-4}
h_{21e}	330	600	—
h_{22e}	30 (<60)	60 (<110)	μS

Total perm. power dissipation versus temperature

$P_{tot} = f(T_{amb})$

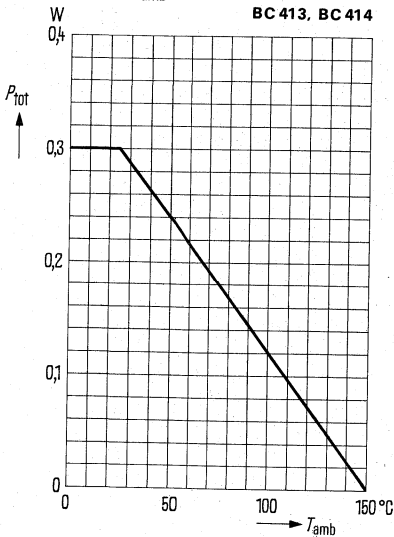

Permissible pulse load

$t_{thJA} = f(t)$ $v =$ parameter

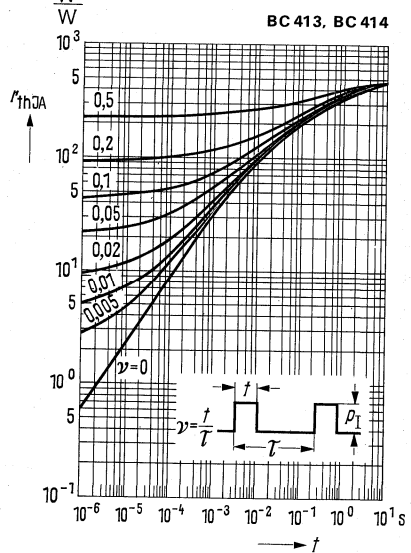

DC current gain $h_{FE} = f(I_C)$;
 $V_{CE} = 5\text{ V}$; $T_{amb} = \text{parameter}$
(common emitter configuration)

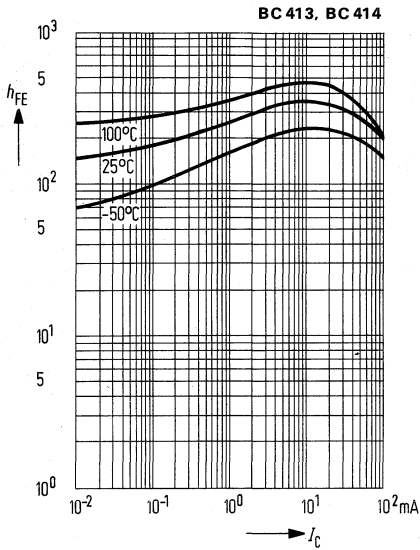

Collector cutoff current versus temperature $I_{CBO} = f(T_{amb})$
 $V_{CB} = 30\text{ V}$

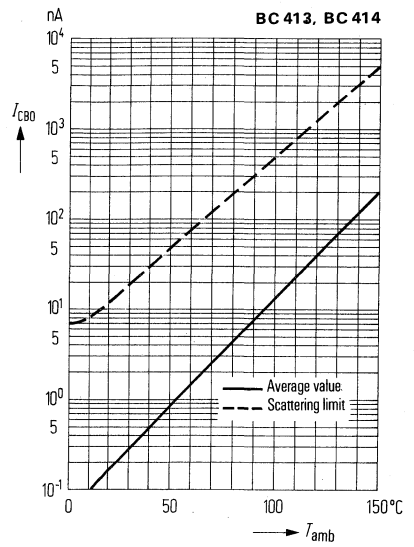

Collector current $I_C = f(V_{BE})$
 $V_{CE} = 5\text{ V}$
(common emitter configuration)

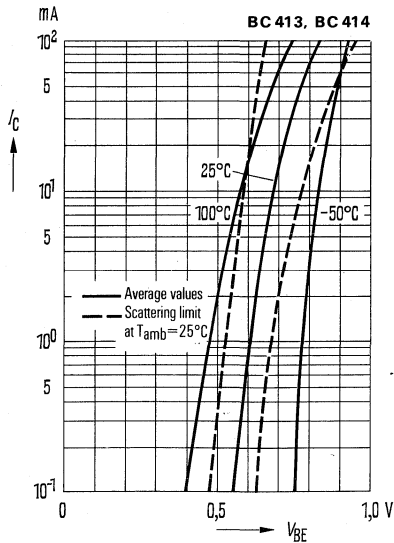

Input characteristic $I_B = f(V_{BE})$
 $V_{CE} = 5\text{ V}$;
(common emitter configuration)

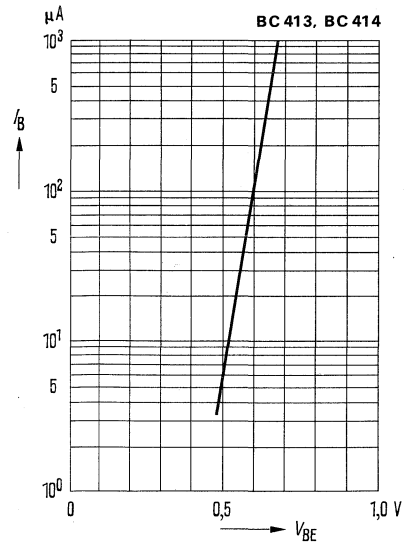

Collector-emitter saturation voltage

$V_{CEsat} = f(I_C); h_{FE} = 20;$

$T_{amb} = \text{parameter}$

(common emitter configuration)

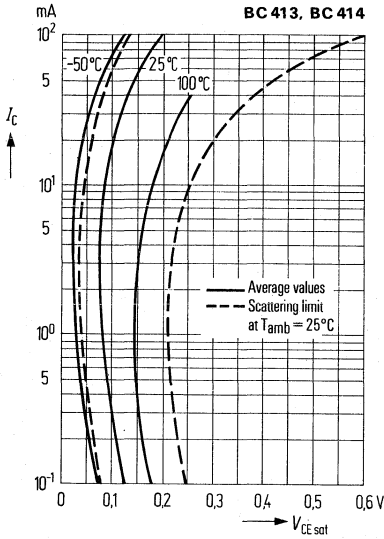

Base-emitter saturation voltage

$V_{BEsat} = f(I_C); h_{FE} = 20;$

$T_{amb} = \text{parameter}$

(common emitter configuration)

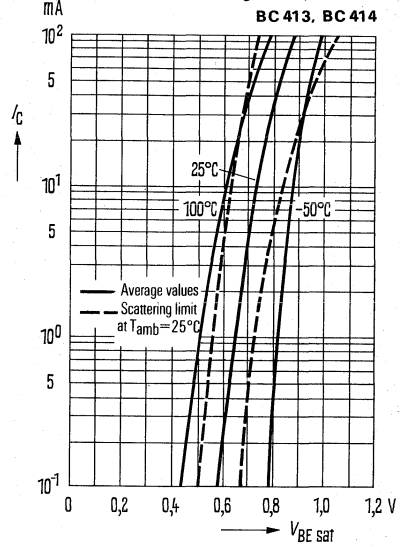

Transition frequency $f_T = f(I_C);$

$V_{CE} = \text{parameter}$

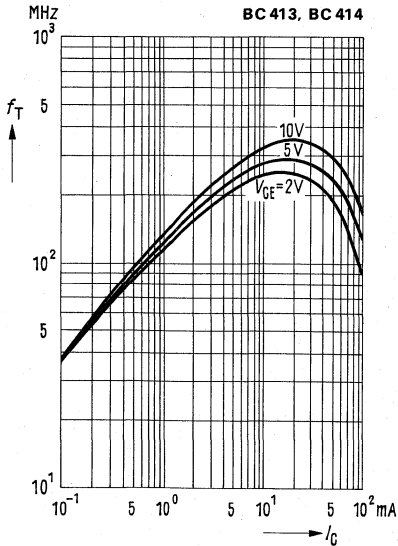

Collector-base capacitance

$C_{CBO} = f(V_{CBO})$

Emitter-base capacitance

$C_{EBO} = f(V_{EBO})$

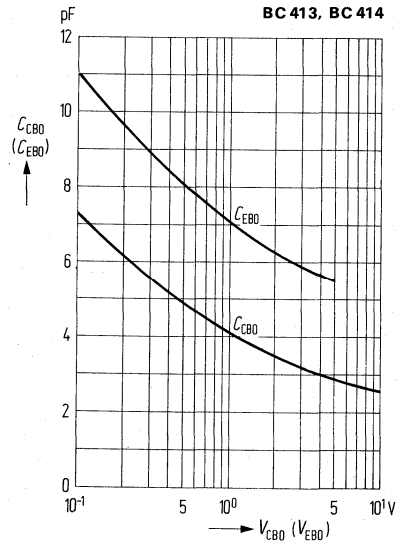

***h*-parameter versus collector current**

$$H_e = \frac{h_e(I_C)}{h_e(I_C = 2 \text{ mA})} = f(I_C)$$

$V_{CE} = 5 \text{ V}$

BC 413, BC 414

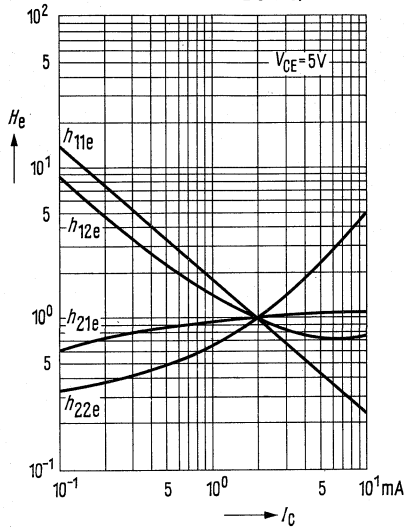

***h*-parameter versus collector-emitter voltage**

$$H_e = \frac{h(V_{CE})}{h(V_{CE} = 5 \text{ V})} = f(V_{CE})$$

$I_C = 2 \text{ mA}$

BC 413, BC 414

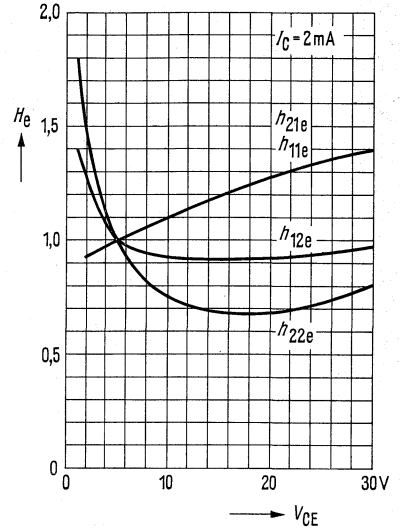

Noise figure $NF = f(I_C)$

$V_{CE} = 5 \text{ V}; f = 1 \text{ kHz};$
 $R_g = \text{parameter}$

BC 413, BC 414

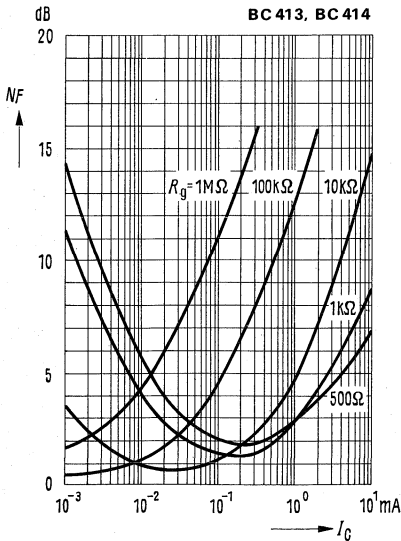

Noise figure $NF = f(I_C)$

$V_{CE} = 5 \text{ V}; f = 120 \text{ Hz}$
 $R_g = \text{parameter}$

BC 413, BC 414

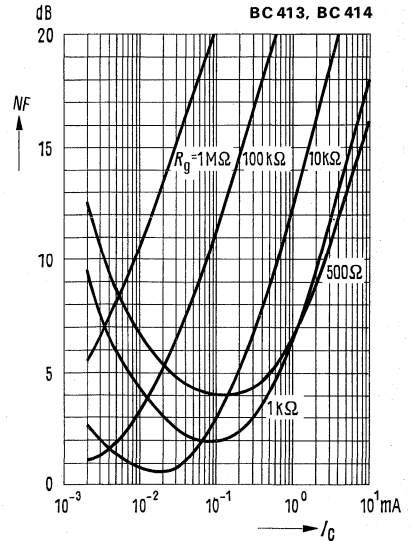

Noise figure $NF = f(I_C)$
 $V_{CE} = 5\text{ V}; f = 10\text{ kHz}$
 $R_g = \text{parameter}$

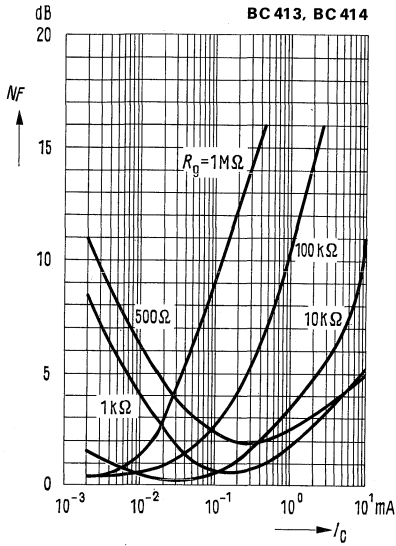

Noise figure $NF = f(V_{CE})$
 $I_C = 0.2\text{ mA}; R_g = 2\text{ k}\Omega; f = 10\text{ kHz}$
 $\Delta f = 200\text{ Hz}; T_{amb} = 25^\circ\text{C}$

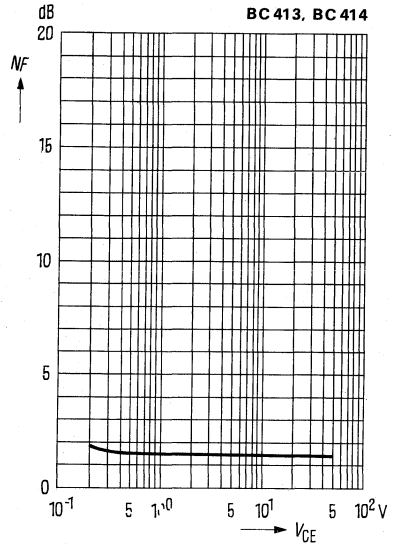

Noise figure $NF = f(f)$
 $R_g = 2\text{ k}\Omega; V_{CE} = 5\text{ V}; I_C = 0.2\text{ mA}$
 $T_{amb} = 25^\circ\text{C}$

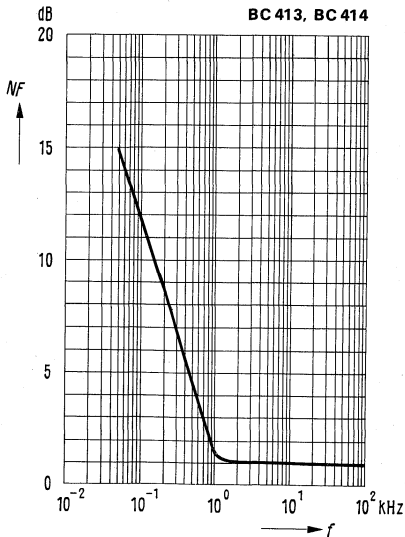

BC 415 and BC 416 are epitaxial PNP silicon planar transistors in TO 92 plastic packages (10 A 3 DIN 41 868). They are intended for use in low-noise AF input stages and as complementary transistors to BC 413 and BC 414.

Type	Ordering code
BC 415 ¹⁾	Q62702-C377
BC 415 A	Q62702-C377-V1
BC 415 B	Q62702-C377-V2
BC 415 C	Q62702-C377-V3
BC 416 ¹⁾	Q62702-C378
BC 416 A	Q62702-C378-V1
BC 416 B	Q62702-C378-V2
BC 416 C	Q62702-C378-V3

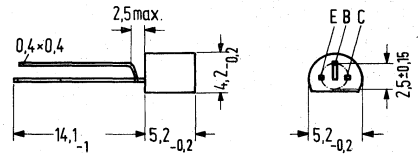

Mounting instruction: Fixing hole dia 0.6
Approx. weight 0.25 g
Dimensions in mm

Maximum ratings

	BC 415	BC 416		
Collector-emitter voltage	-V _{CEO}	35	45	V
Collector-base voltage	-V _{CBO}	45	50	V
Emitter-base voltage	-V _{EBO}	5	5	V
Collector current	-I _C	100	100	mA
Base current	-I _B	20	20	mA
Junction temperature	T _j	150	150	°C
Storage temperature range	T _{stg}	-65 to +150		°C
Total power dissipation (T _{amb} = 25 °C)	P _{tot}	300	300	mW

Thermal resistance

	R _{thJA}	400	400	K/W
Junction to ambient air				

Static characteristics (T_{amb} = 25 °C)

The transistors are grouped in accordance with the DC current gain h_{FE} and marked by A, B, and C. At -V_{CE} = 5 V and the collector currents tabulated below, the following static characteristics apply.

h _{FE} group		A	B	C
Type		BC 415, BC 416	BC 415, BC 416	BC 415, BC 416
-I _C (mA)	-V _{CE} (V)	h _{FE} I _C /I _B	h _{FE} I _C /I _B	h _{FE} I _C /I _B
0.01	5	90 (>40)	150 (>100)	270 (>100)
2	5	170 (120 to 220)	290 (180 to 460)	500 (380 to 800)

1) If the order does not include any exact indication of the current amplification group desired, a transistor of a current amplification group just available from stock will be delivered.

Type	BC 415, BC 416				
$-V_{CE}$ (V)	$-I_C$ (mA)	$-I_B$ (mA)	$-V_{BE}$ (V)	$-V_{CEsat}$ (V)	$-V_{BEsat}$ (V)
5	0.01	—	0.52	—	—
5	0.1	—	0.55	—	—
—	10	0.5	—	0.075 (<0.25)	—
—	100	5	—	0.25 (<0.6)	0.9
5	2	—	0.65 (0.55 to 0.75)	—	—
1	10	—	—	0.25 (<0.6) ¹⁾	—

Static characteristics ($T_{amb} = 25^\circ\text{C}$)

	BC 415	BC 416	
Collector cutoff current ($-V_{CB} = 30\text{ V}$)	$-I_{CBO} < 15$	< 15	nA
Collector cutoff current ($-V_{CB} = 30\text{ V}; T_{amb} = 150^\circ\text{C}$)	$-I_{CBO} < 5$	< 5	μA
Emitter cutoff current ($-V_{EB} = 4\text{ V}$)	$-I_{EBO} < 15$	< 15	nA
Collector-emitter breakdown voltage ($-I_C = 10\text{ mA}$)	$-V_{(BR)CEO} > 35$	> 45	V
Collector-base breakdown voltage ($-I_C = 10\text{ }\mu\text{A}$)	$-V_{(BR)CBO} > 45$	> 50	V
Emitter-base breakdown voltage ($-I_C = 10\text{ }\mu\text{A}$)	$-V_{(BR)EBO} > 5$	> 5	V

Dynamic characteristics ($T_{amb} = 25^\circ\text{C}$)

Transition frequency ($-I_C = 10\text{ mA};$ $-V_{CE} = 5\text{ V}; f = 100\text{ MHz}$)	f_T	200	200	MHz
Collector-base capacitance ($-V_{CB} = 10\text{ V}; I_E = 0; f = 1\text{ MHz}$)	C_{CBO}	4.5	4.5	pF
Noise figure ($-I_C = 0.2\text{ mA};$ $-V_{CE} = 5\text{ V}; f = 30\text{ Hz to } 15\text{ kHz}$)	NF	<2	<2	dB
Equivalent, base referred noise voltage ²⁾ ($-I_C = 0.2\text{ mA}; -V_{CE} = 5\text{ V};$ $R_g = 2\text{ k}\Omega; f = 10\text{ to } 50\text{ Hz}$)	E_n	<0.11	<0.11	μV

Test circuit for noise voltage measurement

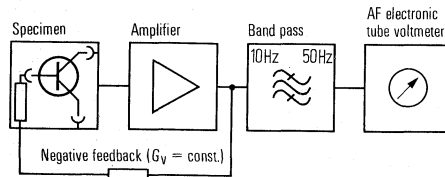

- 1) For the characteristic which passes through the point $I_C = 11\text{ mA}; V_{CE} = 1\text{ V}$ at constant base current.
- 2) Test circuit for noise voltage measurement.

Dynamic characteristics ($T_{amb} = 25^{\circ}\text{C}$)

$-I_C = 2 \text{ mA}; -V_{CE} = 5 \text{ V}; f = 1 \text{ kHz}$

Type	BC 415, BC 416			
h_{FE} group	A	B	C	
h_{11e}	2.7 (1,6 to 4,5)	4.5 (3,2 to 8,5)	8.7 (6 to 15)	k Ω
h_{12e}	1.5	2	3	10^{-4}
h_{21e}	220	330	600	-
h_{22e}	18 (<30)	30 (<60)	60 (<110)	μs

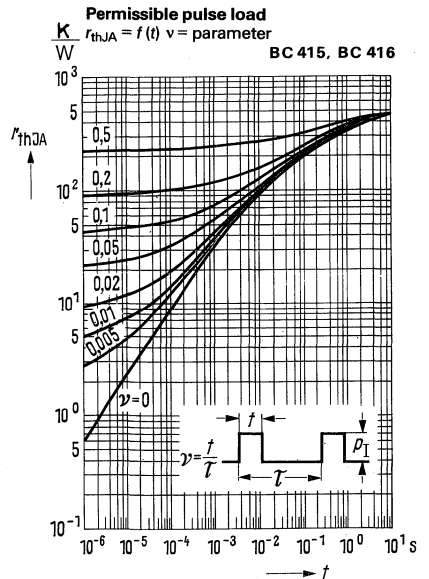
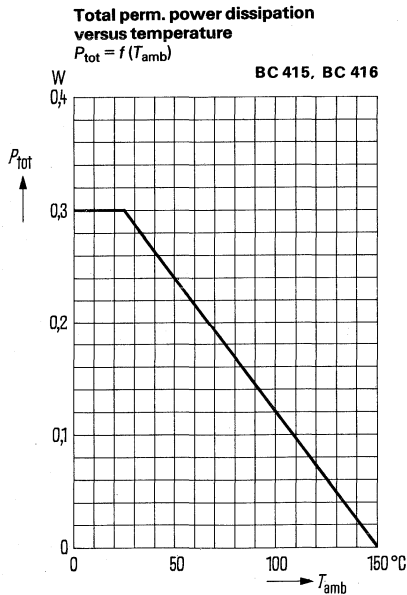

DC current gain
 $h_{FE} = f(I_C); -V_{CE} = 5\text{ V}$

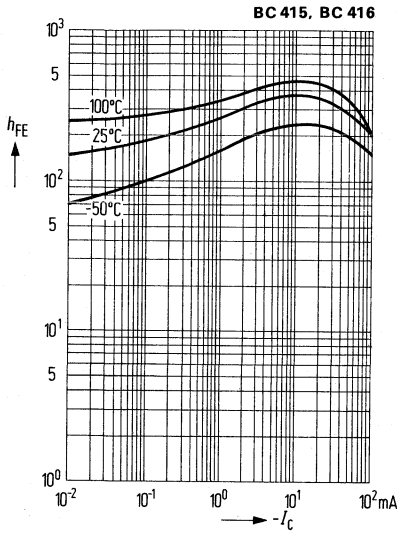

Collector cutoff current versus temperature
 $I_{CBO} = f(T_{amb})$

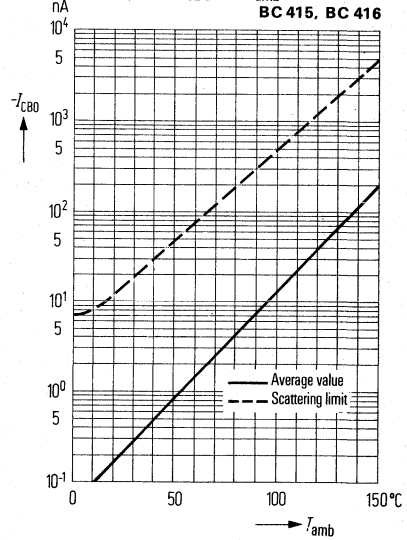

Collector current $I_C = f(V_{BE})$
 $(-V_{CE} = 5\text{ V})$

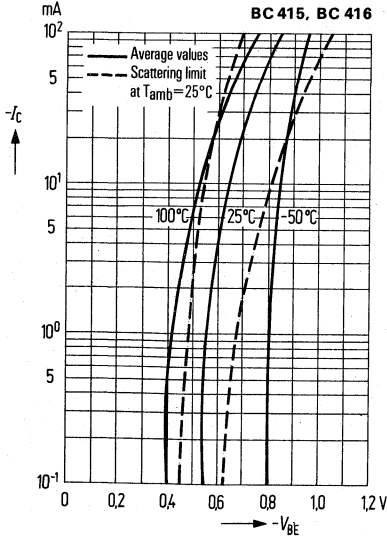

Input characteristic $I_B = f(V_{BE})$
 $-V_{CE} = 5\text{ V}; T_{amb} = 25^\circ\text{C}$

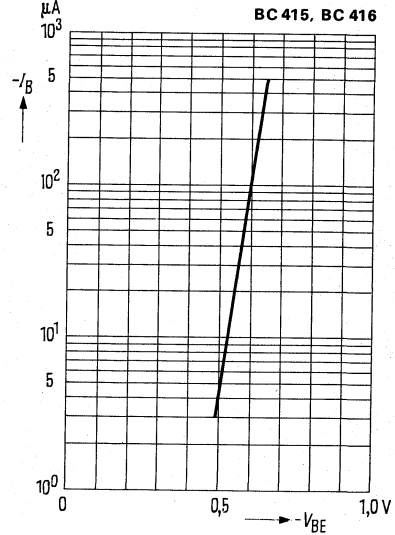

Collector-emitter saturation voltage

$V_{CEsat} = f(I_C); h_{FE} = 20;$
 $T_{amb} = \text{parameter}$

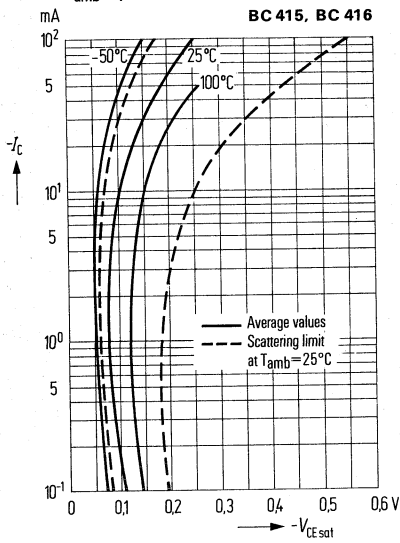

Base-emitter saturation voltage

$C_{BEsat} = f(I_C); h_{FE} = 20;$
 $T_{amb} = \text{parameter}$

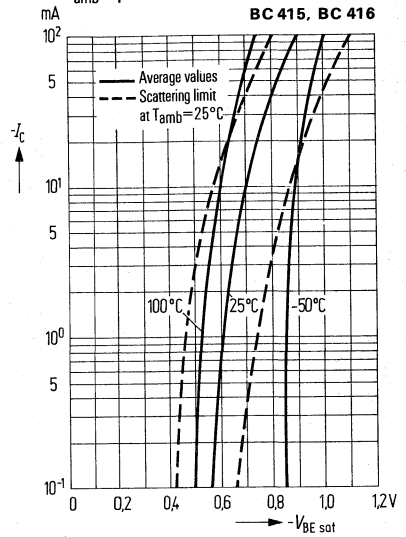

Transition frequency $f_T = f(I_C);$

$T_{amb} = 25^\circ\text{C}$

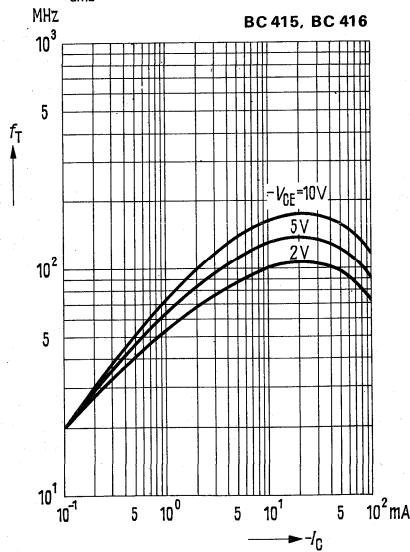

Collector-base capacitance

$C_{CB0} = f(V_{CB0})$

Emitter-base capacitance

$C_{EB0} = f(V_{EB0})$

$f = 1\text{MHz}$

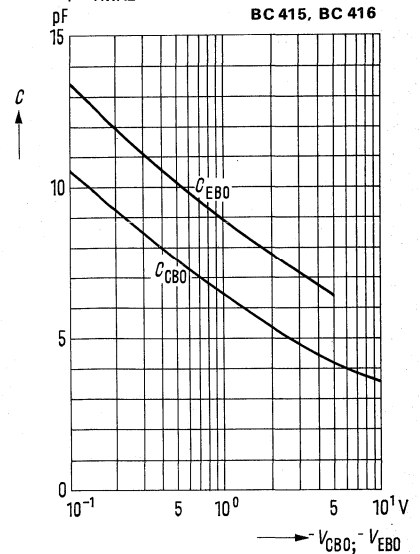

h-parameter versus collector current

$-V_{CE} = 5\text{ V}; T_{amb} = 25^\circ\text{C}$

$$H_e = \frac{h_e(I_C)}{h_e(I_C = 2\text{ mA})} = f(I_C)$$

BC 415, BC 416

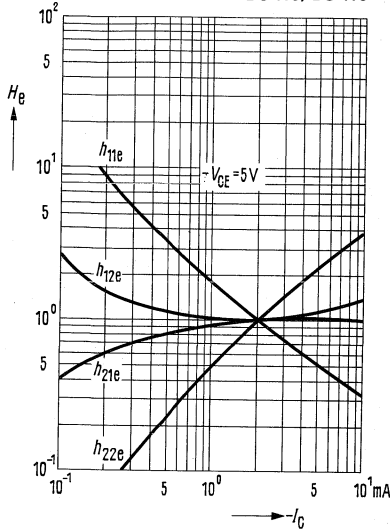

h-parameter versus collector-emitter voltage

$I_C = 2\text{ mA}; T_{amb} = 25^\circ\text{C}$

$$H_e = \frac{h_e(V_{CE})}{h_e(V_{CE} = 5\text{ V})} = f(V_{CE})$$

BC 415, BC 416

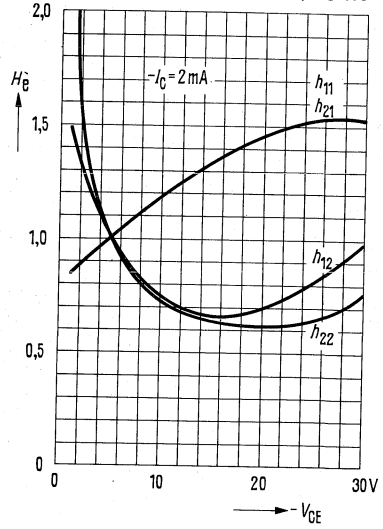

Noise figure $NF = f(I_C)$

$-V_{CE} = 5\text{ V}; f = 120\text{ Hz};$

$T_{amb} = 25^\circ\text{C}$

BC 415, BC 416

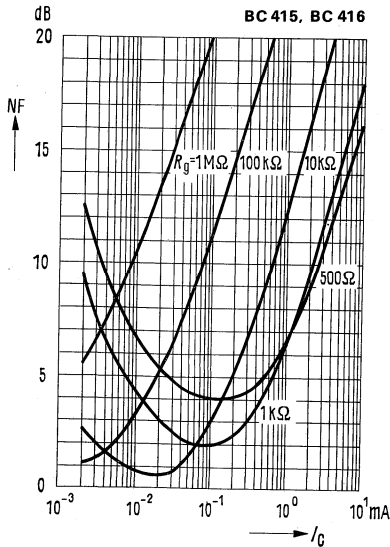

Noise figure $NF = f(I_C)$

$-V_{CE} = 5\text{ V}; f = 1\text{ kHz};$

$T_{amb} = 25^\circ\text{C}$

BC 415, BC 416

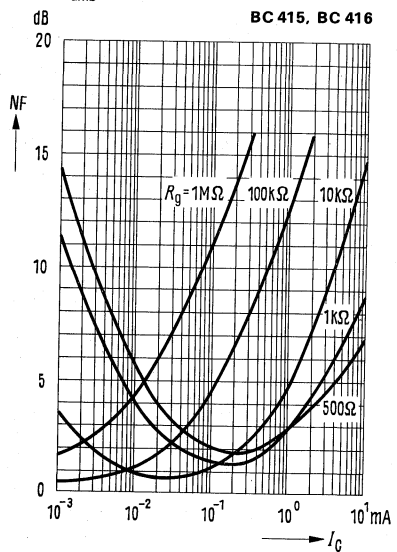

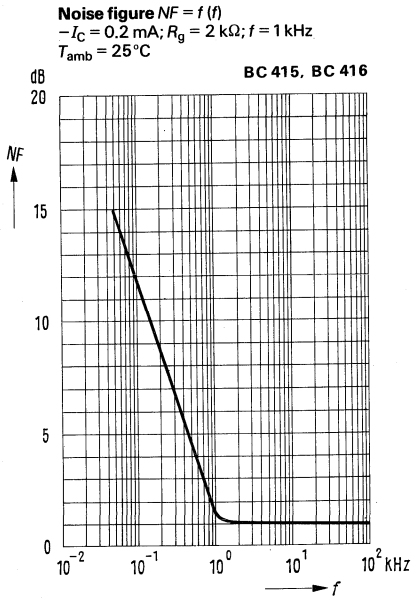
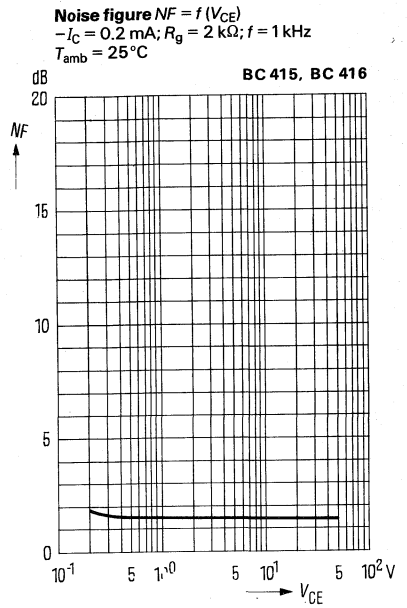
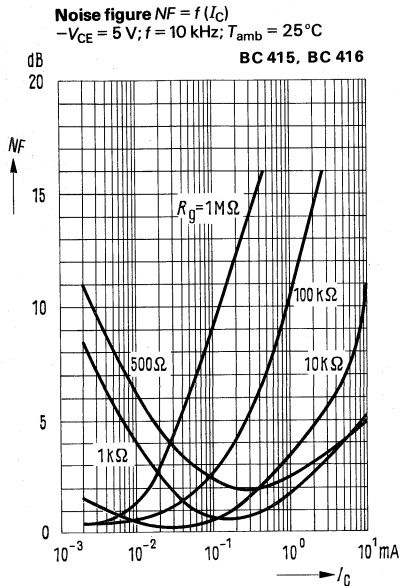

BC 516 is an epitaxial PNP silicon planar darlington transistor in TO 92 plastic package (10 A 3 DIN 41868). Owing to its particularly high current amplification, this darlington transistor is intended for the following AF applications: As relay driver or complementary driver for power output stages for use in power supply units or other highly amplifying stages.

It is provided as complementary transistor to BC 517.

Type	Ordering code
BC 516	Q62702-C944

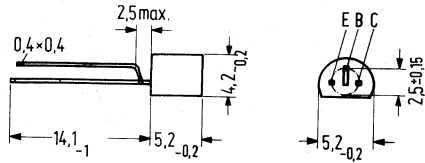
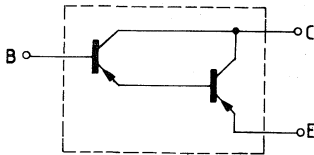

Mounting instruction: Fixing hole dia 0.6
Approx. weight 0.25 g
Dimensions in mm

Maximum ratings ($T_{amb} = 25^\circ\text{C}$)

Collector-emitter voltage	$-V_{CEO}$	30	V
Collector-base voltage	$-V_{CBO}$	40	V
Emitter-base voltage	$-V_{EBO}$	10	V
Collector current	$-I_C$	400	mA
Junction temperature	T_j	150	$^\circ\text{C}$
Storage temperature range	T_{stg}	-55 to +150	$^\circ\text{C}$
Total power dissipation ($T_{amb} \leq 25^\circ\text{C}$)	P_{tot}	625	mW

Thermal resistance

Junction to ambient air	R_{thJA}	≤ 200	K/W
Junction to case	R_{thJC}	≤ 90	K/W

Static characteristics ($T_{amb} = 25^{\circ}\text{C}$)

- Collector cutoff current
($-V_{CB} = 30\text{ V}$)
- Collector-emitter breakdown voltage
($-I_C = 2\text{ mA}$)
- Collector-base breakdown voltage
($-I_C = 10\text{ }\mu\text{A}$)
- Emitter-base breakdown voltage
($-I_E = 100\text{ nA}$)
- DC current gain
($-I_C = 20\text{ mA}$, $-V_{CE} = 2\text{ V}$)
- Collector-emitter saturation voltage
($-I_C = 100\text{ mA}$, $-I_B = 0.1\text{ mA}$)
- Base-emitter voltage ($I_C = 10\text{ mA}$, $V_{CE} = 5\text{ V}$)

$-I_{CBO}$	< 100	nA
$-V_{(BR)CEO}$	> 30	V
$-V_{(BR)CBO}$	> 40	V
$-V_{(BR)EBO}$	> 10	V
h_{FE}	> 30000	-
$-V_{CEsat}$	< 1	V
$-V_{BE}$	< 1.4	V

Dynamic characteristics ($T_{amb} = 25^{\circ}\text{C}$)

- Transition frequency
($-I_C = 10\text{ mA}$; $-V_{CE} = 5\text{ V}$; $f = 100\text{ MHz}$)

f_T	220	MHz
-------	-----	-----

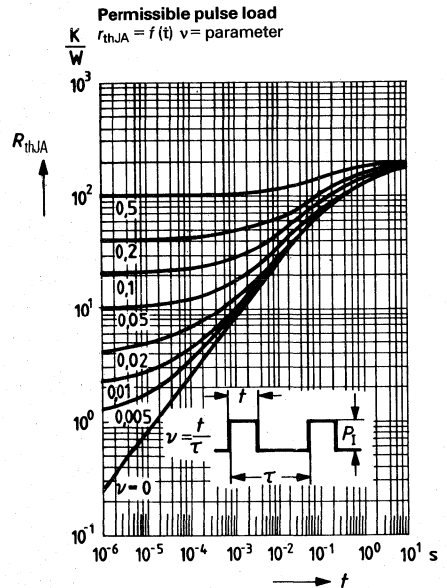
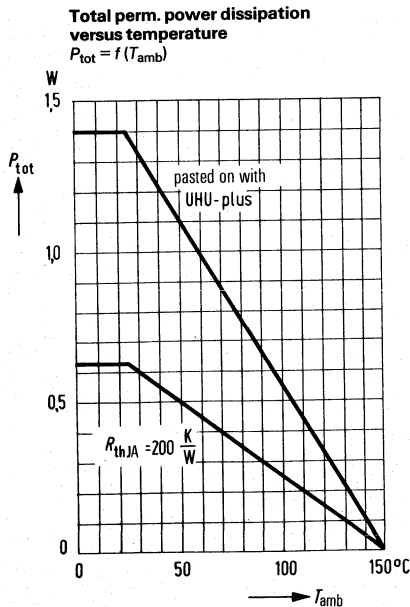

Collector-cutoff current versus temperature $I_{CES} = f(T_{amb})$

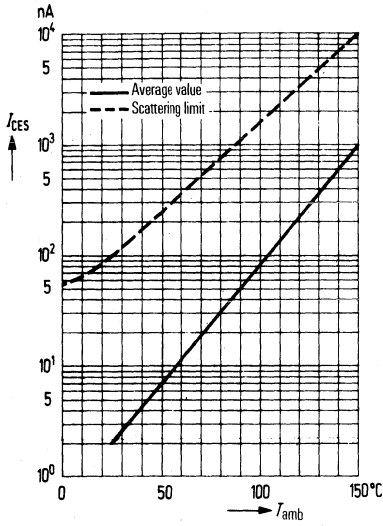

Collector current $I_C = f(V_{BE})$
 $V_{CE} = 2\text{ V}; T_{amb} = 25^{\circ}C$

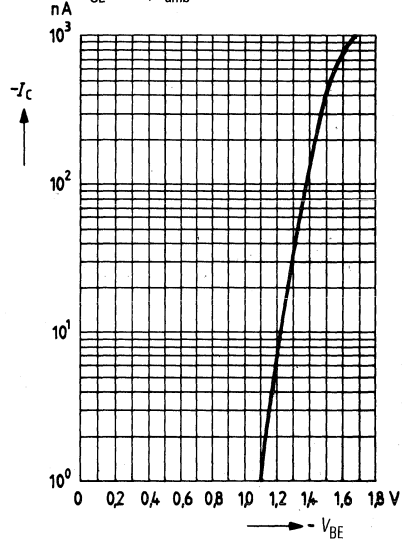

DC current gain $h_{FE} = f(I_C)$
 $-V_{CE} = 2\text{ V}; T = \text{parameter}$

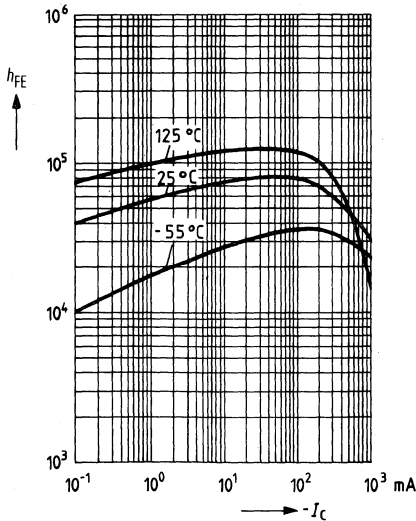

Collector-emitter saturation voltage
 $V_{CEsat} = f(I_C)$
 $h_{FE} = 1000; T_{amb} = \text{parameter}$

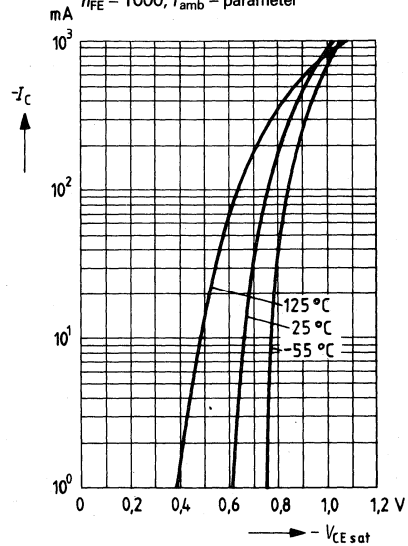

BC 517 is an epitaxial NPN silicon planar darlington transistor in TO 92 plastic package (10 A 3 DIN 41868). Owing to its particularly high current amplification, this darlington transistor is intended for the following AF applications: As relay driver or complementary driver for power output stages for use in power supply units or other highly amplifying stages.

It is provided as complementary transistor to BC 516.

Type	Ordering code
BC 517	Q62702-C825

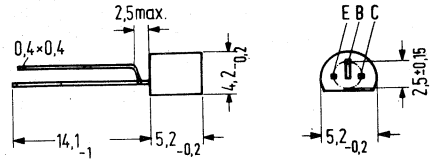
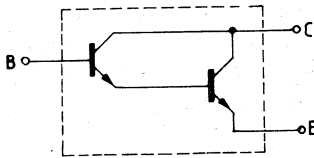

Mounting instruction: Fixing hole dia 0.6
Approx. weight 0.25 g

Dimensions in mm

Maximum ratings ($T_{amb} = 25^{\circ}\text{C}$)

Collector-emitter voltage	V_{CEO}	30	V
Collector-base voltage	V_{CBO}	40	V
Emitter-base voltage	V_{EBO}	10	V
Collector current	I_C	400	mA
Junction temperature	T_j	150	$^{\circ}\text{C}$
Storage temperature range	T_{stg}	-55 to +150	$^{\circ}\text{C}$
Total power dissipation ($T_{amb} \leq 25^{\circ}\text{C}$)	P_{tot}	625	mW

V_{CEO}	30	V
V_{CBO}	40	V
V_{EBO}	10	V
I_C	400	mA
T_j	150	$^{\circ}\text{C}$
T_{stg}	-55 to +150	$^{\circ}\text{C}$
P_{tot}	625	mW

Thermal resistance

Junction to ambient air	R_{thJA}	≤ 200	K/W
Junction to case	R_{thJC}	≤ 90	K/W

R_{thJA}	≤ 200	K/W
R_{thJC}	≤ 90	K/W

Static characteristics ($T_{amb} = 25^{\circ}\text{C}$)

Collector cutoff current

($V_{CB} = 30\text{ V}$)

Collector-emitter breakdown voltage

($I_C = 2\text{ mA}$)

Collector-base breakdown voltage

($I_C = 10\text{ }\mu\text{A}$)

Emitter-base breakdown voltage ($I_E = 100\text{ nA}$)

DC current gain

($I_C = 20\text{ mA}$; $V_{CE} = 2\text{ V}$)

Collector-emitter saturation voltage

($I_C = 100\text{ mA}$, $I_B = 0.1\text{ mA}$)

Base-emitter voltage ($-I_C = 10\text{ mA}$; $-V_{CE} = 5\text{ V}$)

I_{CBO}	< 100	nA
$V_{(BR)CEO}$	> 30	V
$V_{(BR)CBO}$	> 40	V
$V_{(BR)EBO}$	> 10	V
h_{FE}	> 30000	-
V_{CEsat}	< 1	V
V_{BE}	< 1.4	V

Dynamic characteristics ($T_{amb} = 25^{\circ}\text{C}$)

Transition frequency

($I_C = 10\text{ mA}$, $V_{CE} = 5\text{ V}$, $f = 100\text{ MHz}$)

f_T	220	MHz
-------	-----	-----

Total perm. power dissipation versus temperature

$P_{tot} = f(T_{amb})$

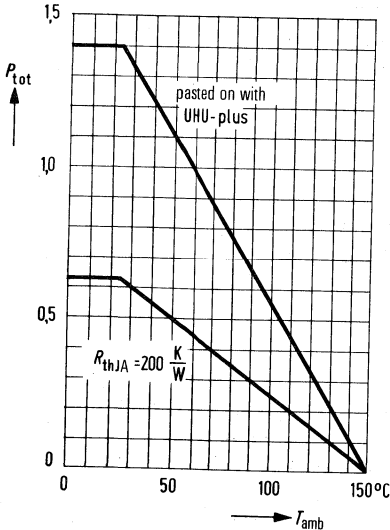

Permissible pulse load

$R_{thJA} = f(t)$ v = parameter

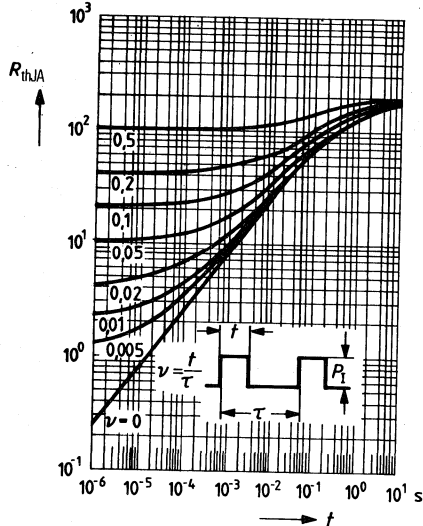

Collector cutoff current versus temperature $I_{CES} = f(T_{amb})$

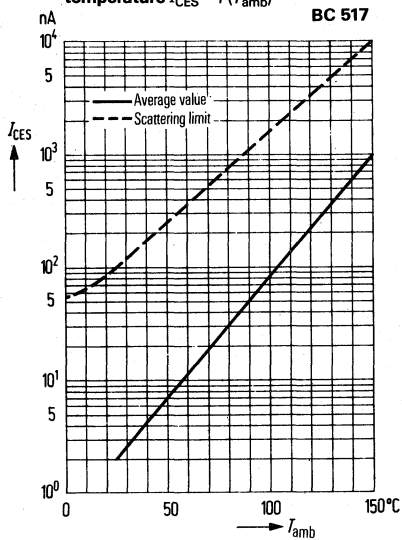

Collector current $I_C = f(V_{BE})$
 $V_{CE} = 2 V; T_{amb} = 25^{\circ}C$

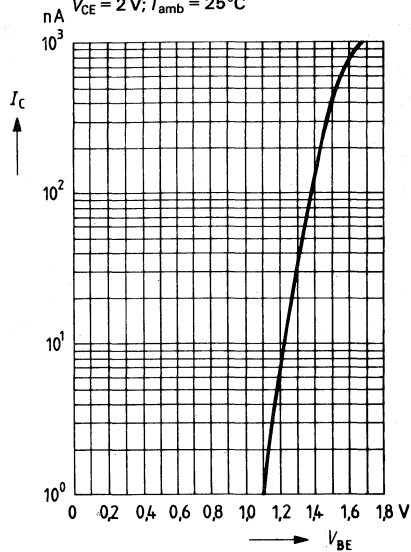

DC current gain $h_{FE} = f(I_C)$:
 $V_{CE} = 2 V; T_{amb} = \text{parameter}$

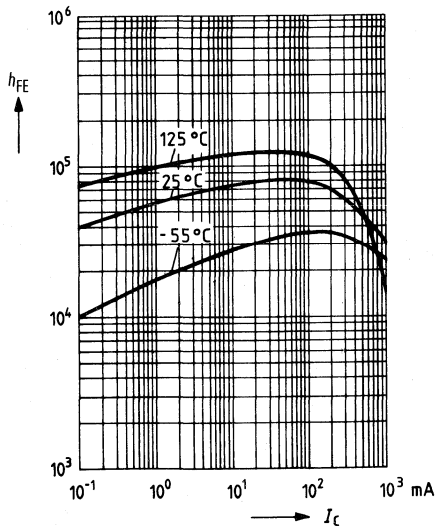

Collector emitter saturation voltage
 $V_{CEsat} = f(I_C); h_{FE} = 1000$
 $T_{amb} = \text{parameter}$

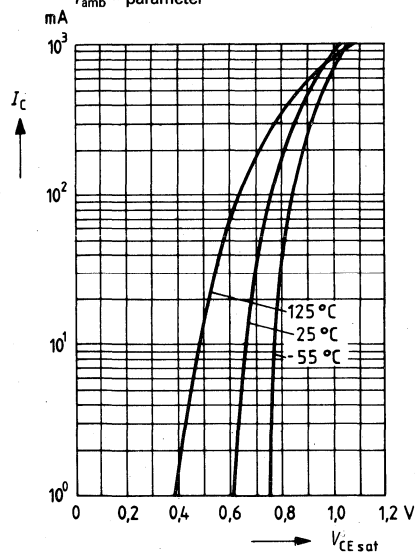

BC 546, BC 547, BC 548, BC 549 and BC 550 are epitaxial NPN silicon planar transistors in TO 92 plastic packages (10 A 3 DIN 41868). They are intended for use in AF input and driver stages (BC 549; BC 550 for low-noise input stages) and as complementary transistors to BC 556, BC 557, BC 558, BC 559 and BC 560.

Type	Ordering code
BC 546 ¹⁾	Q62702-C687
BC 546 VI	Q62702-C687-V3
BC 546 A	Q62702-C687-V1
BC 546 B	Q62702-C687-V2
BC 547 ¹⁾	Q62702-C688
BC 547 VI	Q62702-C688-V3
BC 547 A	Q62702-C688-V1
BC 547 B	Q62702-C688-V2
BC 548 ¹⁾	Q62702-C689
BC 548 VI	Q62702-C689-V4
BC 548 A	Q62702-C689-V1
BC 548 B	Q62702-C689-V2
BC 548 C	Q62702-C689-V3

Type	Ordering code
BC 549 ¹⁾	Q62702-C690
BC 549 B	Q62702-C690-V1
BC 549 C	Q62702-C690-V2
BC 550 ¹⁾	Q62702-C691
BC 550 B	Q62702-C691-V1
BC 550 C	Q62702-C691-V2

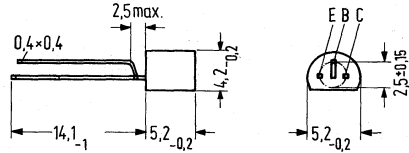

Mounting instruction: Fixing hole dia 0.6
Approx. weight 0.25 g
Dimensions in mm

Maximum ratings

	BC 546	BC 547	BC 548	BC 549	BC 550		
Collector-base voltage	V_{CBO}	80	50	30	30	50	V
Collector-emitter voltage	V_{CES}	80	50	30	30	50	V
Collector-emitter voltage	V_{CEO}	65	45	30	30	45	V
Emitter-base voltage	V_{EBO}	6	6	5	5	5	V
Collector current	I_C	100	100	100	100	100	mA
Collector peak current	I_{CM}	200	200	200	200	200	mA
Base peak current	I_{BM}	200	200	200	200	200	mA
Emitter-peak current	I_{EM}	200	200	200	200	200	mA
Junction temperature	T_j	150	150	150	150	150	°C
Storage temperature range	T_{stg}	-65 to +150					°C
Total power dissipation ($T_{amb} = 25\text{°C}$)	P_{tot}	500	500	500	500	500	mW

Thermal resistance

Junction to ambient air	R_{thJA}	≤ 250	≤ 250	≤ 250	≤ 250	≤ 250	K/W
Junction to case	R_{thJC}	≤ 150	≤ 150	≤ 150	≤ 150	≤ 150	K/W

1) If the order does not include any exact indication of the current amplification group desired, a transistor of a current amplification group just available from stock will be delivered.

Static characteristics ($T_{amb} = 25^{\circ}\text{C}$)

The transistors are grouped in accordance with the DC current gain h_{FE} and are marked by A, B, and C. At $V_{CE} = 5\text{ V}$ and the collector currents tabulated below the following static characteristics apply.

Type	BC 546 BC 547 BC 548	BC 546 BC 547 BC 548	BC 546 BC 547, BC 549 BC 548, BC 550	BC 548, BC 549, BC 550
h_{FE} group	VI	A	B	C
I_C mA	h_{FE} I_C/I_B	h_{FE} I_C/I_B	h_{FE} I_C/I_B	h_{FE} I_C/I_B
0.01		90	150	270
2	110 (75 to 150)	180 (110 to 220)	290 (200 to 450)	500 (420 to 800)
100		120	200	400

Collector cutoff current ($V_{CBO} = 30\text{ V}$)

$I_{CBO} \leq 15$ nA

Collector cutoff current
($V_{CBO} = 30\text{ V}$; $T_{amb} = 150^{\circ}\text{C}$)

$I_{CBO} \leq 5$ μA

Collector-emitter saturation voltage

($I_C = 10\text{ mA}$; $I_B = 0.5\text{ mA}$)

($I_C = 100\text{ mA}$; $I_B = 5\text{ mA}$)

($I_C = 10\text{ mA}$)¹⁾

$V_{CEsat} 90 (<250)$ mV

$V_{CEsat} 200 (<600)$ mV

$V_{CEsat} 300 (<600)$ mV

Base-emitter saturation voltage²⁾

($I_C = 10\text{ mA}$; $I_B = 0.5\text{ mA}$)

($I_C = 100\text{ mA}$; $I_B = 5\text{ mA}$)

$V_{BEsat} 700$ mV

$V_{BEsat} 900$ mV

Base-emitter voltage

($V_{CE} = 5\text{ V}$; $I_C = 2\text{ mA}$)

$V_{BE} 660 (580\text{ to }700)$ mV

Base-emitter voltage

($V_{CE} = 5\text{ V}$; $I_C = 10\text{ mA}$)

$V_{BE} < 720$ mV

1) For the characteristic which passes through the point $I_C = 11\text{ mA}$; $V_{CE} = 1\text{ V}$ at constant base current.

2) $\frac{\Delta V_{BEsat}}{\Delta T_j}$ approx. = 1.7 mV/K; $\frac{\Delta V_{BE}}{\Delta T_j}$ approx. = -2 mV/K

		BC 546 BC 547 BC 548	BC 549	BC 550	
Dynamic characteristics ($T_{amb} = 25^{\circ}\text{C}$)					
Transition frequency ($V_{CE} = 5\text{ V}$; $I_C = 10\text{ mA}$; $f = 100\text{ MHz}$)					
f_T		300	300	300	MHz
Collector-base capacitance ($V_{CBO} = 10\text{ V}$; $f = 1\text{ MHz}$)					
C_{CBO}		2.5 (<4.5)	2.5 (<4.5)	2.5 (<4.5)	pF
Emitter-base capacitance ($V_{EBO} = 0.5\text{ V}$; $f = 1\text{ MHz}$)					
C_{EBO}		9	9	9	pF
Noise figure ($V_{CE} = 5\text{ V}$; $I_C = 200\text{ }\mu\text{A}$; $R_g = 2\text{ k}\Omega$; $f = 1\text{ kHz}$; $\Delta f = 200\text{ Hz}$)					
NF		2 (<10)	1.2 (<4)	1 (<4)	dB
Equivalent noise voltage ($V_{CE} = 5\text{ V}$; $I_C = 200\text{ }\mu\text{A}$; $R_g = 2\text{ k}\Omega$; $f = 10\text{ to }50\text{ Hz}$; $T_{amb} = 25^{\circ}\text{C}$)					
E_n		–	<0.135	<0.135	μV

Dynamic characteristics ($T_{amb} = 25^{\circ}\text{C}$)

$I_C = 2\text{ mA}$; $V_{CE} = 5\text{ V}$; $f = 1\text{ kHz}$

Type	BC 546 BC 547 BC 548	BC 546 BC 547 BC 548	BC 546 BC 547, BC 549 BC 548, BC 550	BC 548, BC 549, BC 550	
h_{FE} group	VI	A	B	C	
h_{11e}	1.2 (0.4 to 2.2)	2.7 (1.6 to 4.5)	4.5 (3.2 to 8.5)	8.7 (6 to 15)	k Ω
h_{12e}	2.5	1.5	2	3	10^{-4}
h_{21e}	110	220	330	600	–
h_{22e}	20 (<40)	18 (<30)	30 (<60)	60 (<110)	μS

Total perm. power dissipation versus temperature
 $P_{tot} = f(T_{amb})$

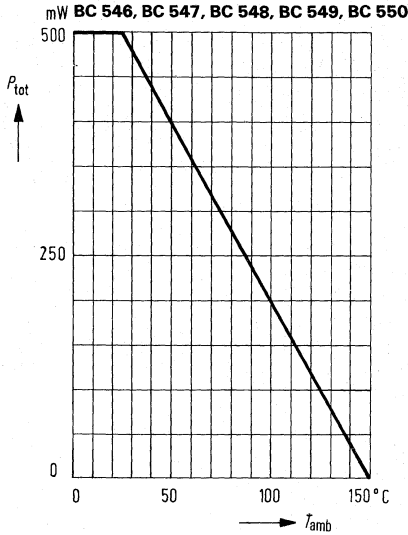

Permissible pulse load
 $r_{thJA} = f(t)$ v = parameter

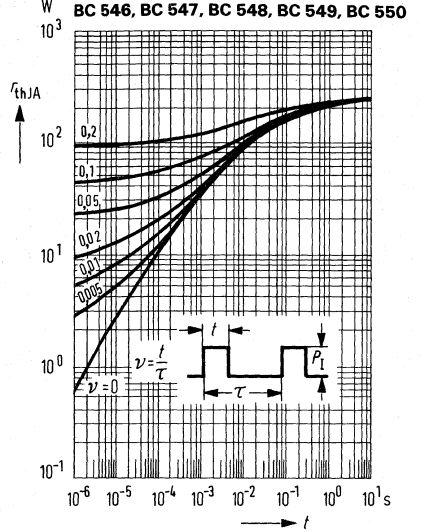

DC current gain $h_{FE} = f(I_C)$
 $V_{CE} = 5 V$; $T_{amb} = \text{parameter}$
 (common-emitter configuration)

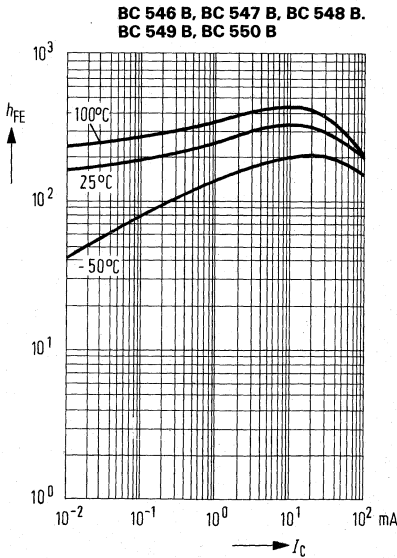

Collector current $I_C = f(V_{BE})$
 $V_{CE} = 5 V$
 (common-emitter configuration)

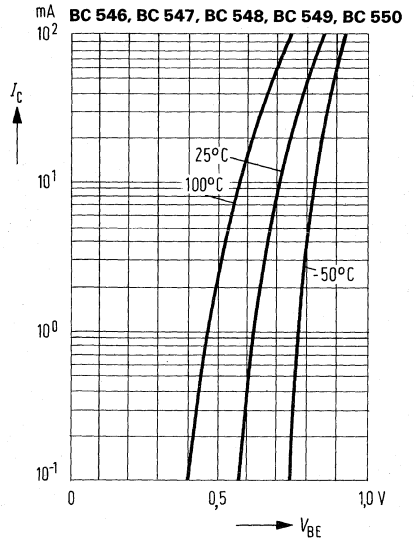

Collector-emitter saturation voltage

$V_{CEsat} = f(I_C); h_{FE} = 20;$

T_{amb} = parameter

(common-emitter configuration)

BC 546, BC 547, BC 548, BC 549, BC 550

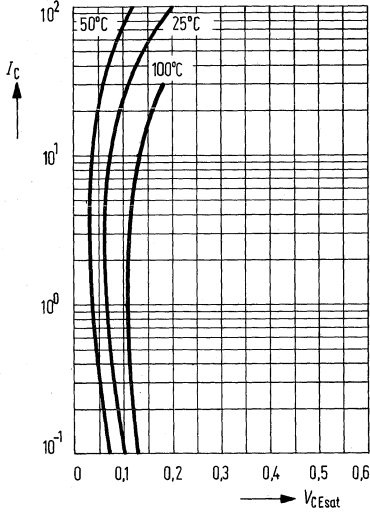

Collector-cutoff current versus temperature
 $I_{CBO} = f(T_{amb})$ for max. permissible reverse voltage

BC 546, BC 547, BC 548, BC 549, BC 550

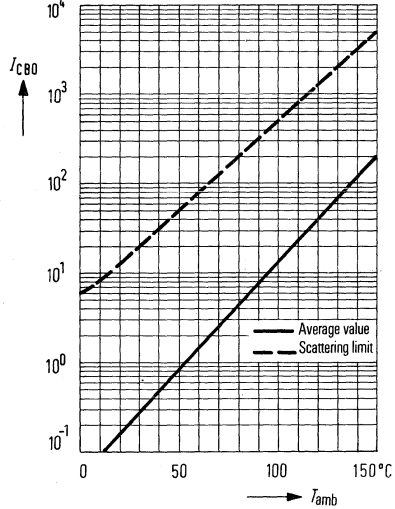

Transition frequency $f_T = f(I_C)$

V_{CE} = parameter; $T_{amb} = 25^\circ\text{C}$

BC 546, BC 547, BC 548, BC 549, BC 550

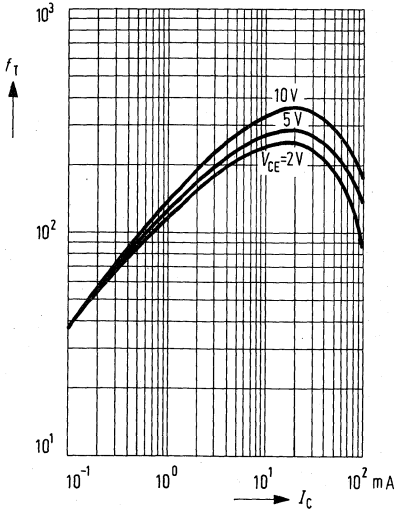

Collector-base capacitance $C_{CBO} = f(V_{CBO})$
Emitter-base capacitance $C_{EBO} = f(V_{EBO})$

BC 546, BC 547, BC 548, BC 549, BC 550

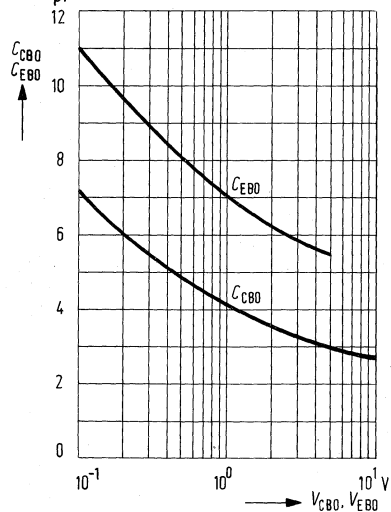

***h*-parameter versus collector current**

$$H_e = \frac{h_e(I_c)}{h_e(I_c = 2 \text{ mA})} = f(I_c)$$

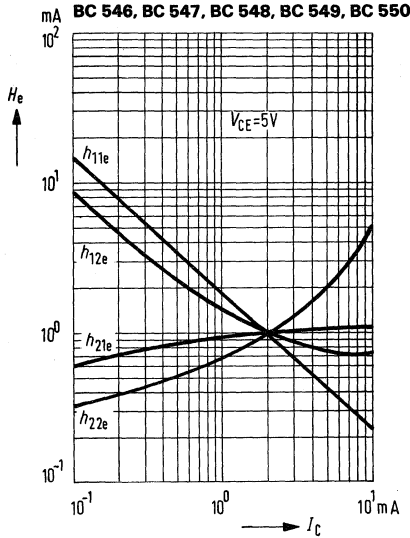

Noise figure $NF = f(V_{CE})$
 $I_c = 0.2 \text{ mA}; R_g = 2 \text{ k}\Omega; f = 1 \text{ kHz}$
 $\Delta f = 200 \text{ Hz}; T_{amb} = 25 \text{ }^\circ\text{C}$

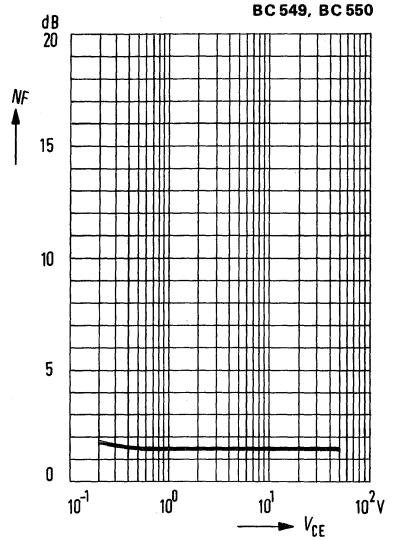

Noise figure $NF = f(I_c)$
 $V_{CE} = 5V; f = 1 \text{ kHz}$

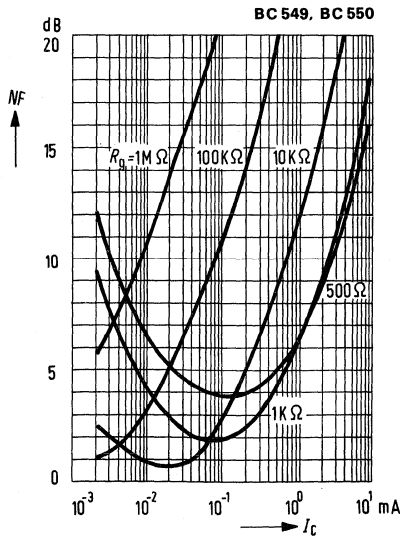

Noise figure $NF = f(I_c)$
 $V_{CE} = 5V; f = 120 \text{ Hz}$

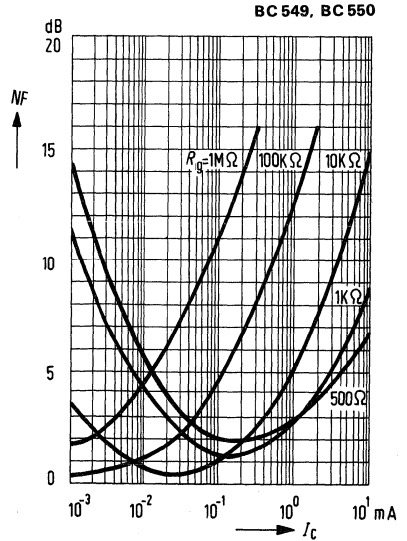

for AF input and driver stages

BC 556, BC 557, BC 558, BC 559, and BC 560 are epitaxial PNP silicon planar transistors in TO 92 plastic package 10 A 3 DIN 41868. They are intended for use in AF input and driver stages (BC 559, BC 560 for low-noise input stages) and as complementary transistors to BC 546, BC 547, BC 548, BC 549, and BC 550.

Type	Ordering code
BC 556 ¹⁾	Q62702-C692
BC 556 VI	Q62702-C692-V3
BC 556 A	Q62702-C692-V1
BC 556 B	Q62702-C692-V2
BC 557 ¹⁾	Q62702-C693
BC 557 VI	Q62702-C693-V3
BC 557 A	Q62702-C693-V1
BC 557 B	Q62702-C693-V2
BC 558 ¹⁾	Q62702-C694
BC 558 VI	Q62702-C694-V4
BC 558 A	Q62702-C694-V1
BC 558 B	Q62702-C694-V2
BC 558 C	Q62702-C694-V3

Type	Ordering code
BC 559 ¹⁾	Q62702-C695
BC 559 A	Q62702-C695-V1
BC 559 B	Q62702-C695-V2
BC 559 C	Q62702-C695-V3
BC 560 ¹⁾	Q62702-C696
BC 560 A	Q62702-C696-V1
BC 560 B	Q62702-C696-V2
BC 560 C	Q62702-C696-V3

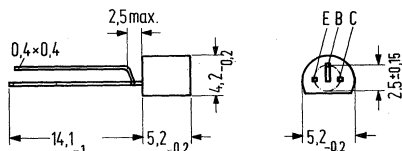

Mounting instruction: Fixing hole dia 0.6
Approx. weight 0.25 g
Dimensions in mm

Maximum ratings

	BC 556	BC 557	BC 558	BC 559	BC 560		
Collector-base voltage	$-V_{CBO}$	80	50	30	30	50	V
Collector-emitter voltage	$-V_{CES}$	80	50	30	30	50	V
Collector-emitter voltage	$-V_{CEO}$	65	45	30	30	45	V
Emitter-base voltage	$-V_{EBO}$	5	5	5	5	5	V
Collector current	$-I_C$	100	100	100	100	100	mA
Collector peak current	$-I_{CM}$	200	200	200	200	200	mA
Base peak current	$-I_{BM}$	200	200	200	200	200	mA
Emitter-peak current	$-I_{EM}$	200	200	200	200	200	mA
Junction temperature	T_j	150	150	150	150	150	°C
Storage temperature range	T_{stg}	-65 to +150					°C
Total power dissipation ($T_{amb} = 25^\circ\text{C}$)	P_{tot}	500	500	500	500	500	mW

Thermal resistance

Junction to ambient air	R_{thJA}	≤ 250	≤ 250	≤ 250	≤ 250	≤ 250	K/W
Junction to case	R_{thJC}	≤ 150	≤ 150	≤ 150	≤ 150	≤ 150	K/W

1) If the order does not include any exact indication of the current amplification group desired, a transistor of a current amplification group just available from stock will be delivered.

Static characteristics ($T_{amb} = 25^{\circ}\text{C}$)

The transistors are grouped in accordance with the DC current gain h_{FE} and are marked by VI, A, B, and C. At $-V_{CE} = 5\text{ V}$ and the collector currents tabulated below the following static characteristics apply.

Type	BC 556 BC 557 BC 558	BC 556 BC 557, BC 559 BC 558, BC 560	BC 556 BC 557, BC 559 BC 558, BC 560	BC 558, BC 559, BC 560
h_{FE} group	VI	A	B	C
$-I_C$ mA	h_{FE} I_C/I_B	h_{FE} I_C/I_B	h_{FE} I_C/I_B	h_{FE} I_C/I_B
0.01	–	90	150	270
2	110 (75 to 150)	180 (110 to 220)	290 (200 to 450)	500 (420 to 800)
100	–	120 ³⁾	200 ³⁾	400 ³⁾

		BC 556 BC 557 BC 558	BC 559 BC 560	
Collector cutoff current ($-V_{CBO} = 30\text{ V}$)	$-I_{CBO}$	≤ 15	≤ 15	nA
($-V_{CBO} = 30\text{ V}$; $T_{amb} = 150^{\circ}\text{C}$)	$-I_{CBO}$	≤ 5	≤ 5	μA
Collector-emitter saturation voltage ($-I_C = 10\text{ mA}$; $-I_B = 0.5\text{ mA}$)	$-V_{CEsat}$	90 (< 300)	90 (< 300)	mV
($-I_C = 100\text{ mA}$; $-I_B = 5\text{ mA}$)	$-V_{CEsat}$	250 (< 650)	250 (< 650)	mV
($-I_C = 10\text{ mA}$) ¹⁾	$-V_{CEsat}$	300 (< 600)	300 (< 600)	mV
Base-emitter saturation voltage ²⁾ ($-I_C = 10\text{ mA}$; $-I_B = 0.5\text{ mA}$)	$-V_{BEsat}$	700	700	mV
($-I_C = 100\text{ mA}$; $-I_B = 5\text{ mA}$)	$-V_{BEsat}$	900	900	mV
Base-emitter voltage ($-V_{CE} = 5\text{ V}$; $-I_C = 2\text{ mA}$)	$-V_{BE}$	660 (600 to 700)	(580 to 700)	mV
Base-emitter voltage ($-V_{CE} = 5\text{ V}$; $-I_C = 10\text{ mA}$)	$-V_{BE}$	< 800	< 720	mV

1) For the characteristic which passes through the point $I_C = 11\text{ mA}$; $V_{CE} = 1\text{ V}$ at constant base current.

2) $\frac{\Delta V_{BEsat}}{\Delta T_1}$ approx. = 1.7 mV/K; $\frac{\Delta V_{BE}}{\Delta T_1}$ approx. = -2 mV/K

3) only applies to BC 556, BC 557, BC 558

Dynamic characteristics ($T_{amb} = 25^{\circ}\text{C}$)		BC 556 BC 557 BC 558	BC 559	BC 560	
Transition frequency ($-V_{CE} = 5\text{ V}$; $-I_C = 10\text{ mA}$; $f = 100\text{ MHz}$)	f_T	150	300	300	MHz
Collector-base capacitance ($-V_{CBO} = 10\text{ V}$; $f = 1\text{ MHz}$)	C_{CBO}	4.5	2.5 (<4.5)	2.5 (<4.5)	pF
Noise figure ($-V_{CE} = 5\text{ V}$; $-I_C = 200\text{ }\mu\text{A}$; $R_g = 2\text{ k}\Omega$ $f = 1\text{ kHz}$; $\Delta f = 200\text{ Hz}$)	NF	2 (<10)	1 (<4)	1 (<4)	dB
($-V_{CE} = 5\text{ V}$; $-I_C = 200\text{ }\mu\text{A}$; $R_g = 2\text{ k}\Omega$ $f = 30\text{ to }15\text{ 000 Hz}$)	NF	–	1.2 (<4)	1.2 (<2)	dB
Equivalent noise voltage ($-V_{CE} = 5\text{ V}$; $-I_C = 200\text{ }\mu\text{A}$; $R_g = 2\text{ k}\Omega$; $f = 10\text{ to }50\text{ Hz}$)	E_n	–	≤ 0.11	≤ 0.11	μV

Dynamic characteristics ($T_{amb} = 25^{\circ}\text{C}$)

$-I_C = 2\text{ mA}$; $-V_{CE} = 5\text{ V}$; $f = 1\text{ kHz}$

Type	BC 556 BC 557 BC 558	BC 556 BC 557, BC 559 BC 558, BC 560	BC 556 BC 557, BC 559 BC 558, BC 560	BC 558, BC 559, BC 560	
h_{FE} group	VI	A	B	C	
h_{11e}	1.2 (0.4 to 2.2)	2.7 (1.6 to 4.5)	4.5 (3.2 to 8.5)	8.7 (6 to 15)	k Ω
h_{12e}	2.5	1.5	2	3	10^{-4}
h_{21e}	110	220	330	600	–
h_{22e}	20 (<40)	18 (<30)	30 (<60)	60 (<110)	μS

Total perm. power dissipation versus temperature
 $P_{tot} = f(T_{amb})$

BC 556, BC 557, BC 558, BC 559, BC 560

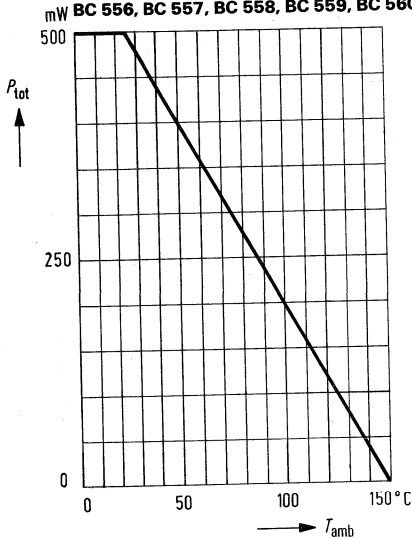

Permissible pulse load

$r_{thJA} = f(t); v = \text{parameter}$

BC 556, BC 557, BC 558, BC 559, BC 560

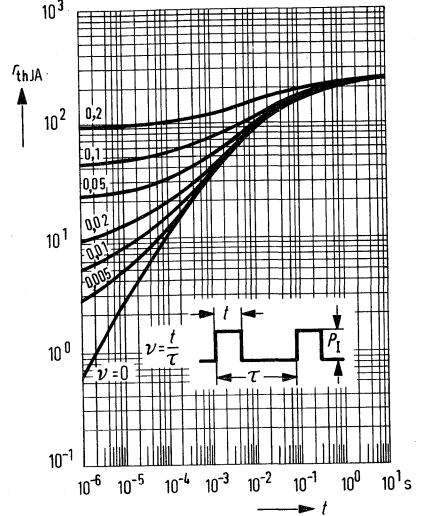

DC current gain $h_{FE} = f(I_C)$

$V_{CE} = 5 \text{ V}; T_{amb} = \text{parameter}$

(common emitter configuration)

BC 556B, BC 557B, BC 558B, BC 559B, BC 560B

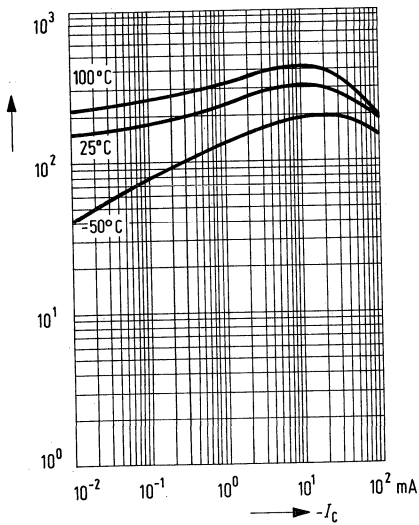

Collector current $I_C = f(V_{BE})$

$-V_{CE} = 5 \text{ V}$

BC 556, BC 557, BC 558, BC 559, BC 560

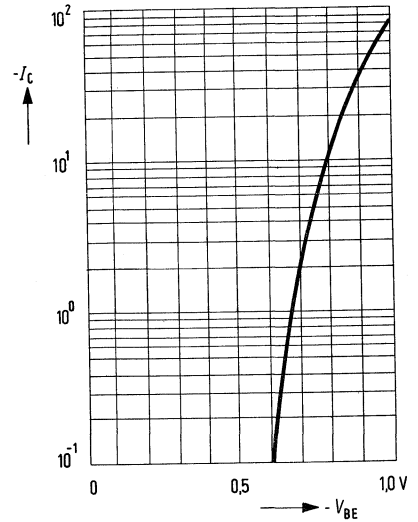

Collector-emitter saturation voltage

$V_{CEsat} = f(I_C); h_{FE} = 20;$
 $T_{amb} = \text{parameter}$
 (common emitter configuration)
BC 556, BC 557, BC 558, BC 559, BC 560

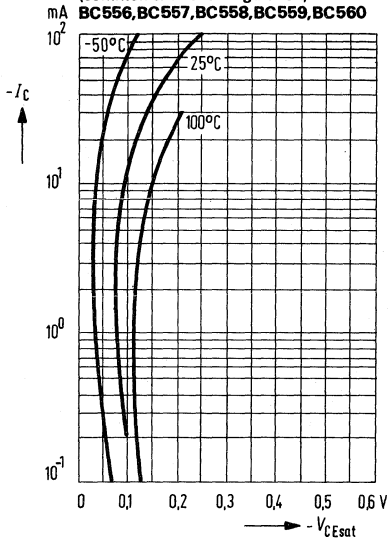

Collector cutoff current versus temperature $I_{CBO} = f(T_{amb})$ for max. permissible reverse voltages

BC 556, BC 557, BC 558, BC 559, BC 560

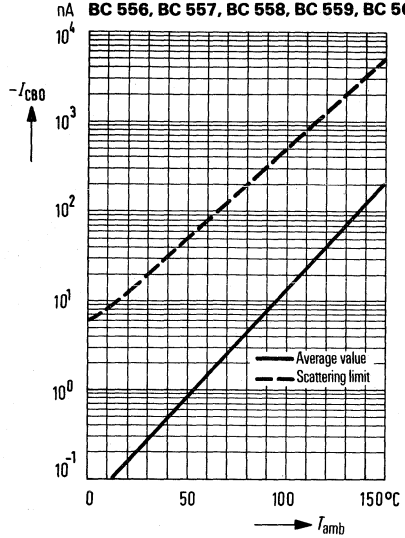

Transition frequency $f_T = f(I_C);$

$T_{amb} = 25^\circ\text{C}$
 $V_{CE} = \text{parameter}$
BC 556, BC 557, BC 558, BC 559, BC 560

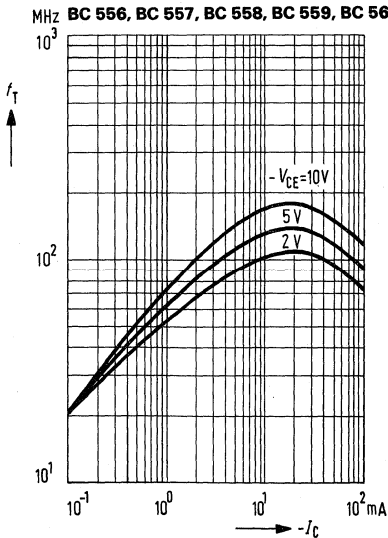

Collector-base capacitance $C_{CB} = f(V_{CBO})$

Emitter-base capacitance $C_{EBO} = f(V_{EBO})$
 $f = 1\text{ MHz}; T_{amb} = 25^\circ\text{C}$
BC 556, BC 557, BC 558, BC 559, BC 560

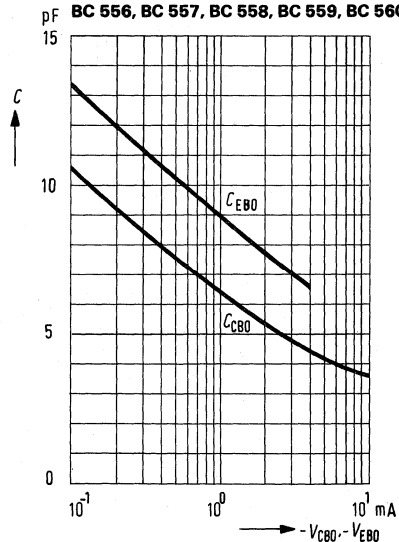

***h*-parameter versus collector current**

$$H_e = \frac{h_o(I_C)}{h_o(I_C = 2 \text{ mA})} = f(I_C)$$

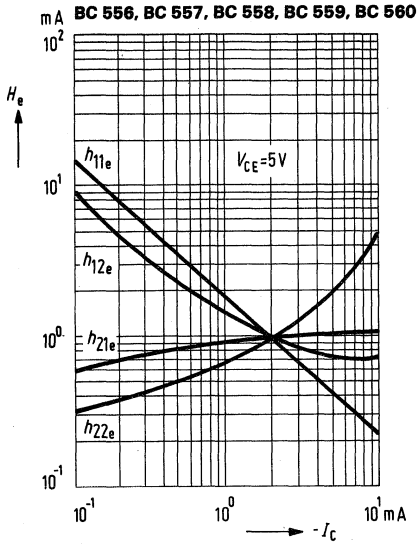

Noise figure $NF = f(V_{CE})$
 $I_C = 0.2 \text{ mA}; R_G = 2 \text{ k}\Omega; f = 1 \text{ kHz}$
 $\Delta f = 200 \text{ Hz}; T_{amb} = 25^\circ \text{C}$

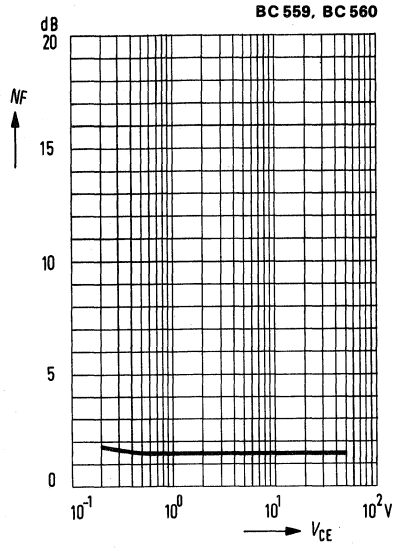

Noise figure $NF = f(I_C)$
 $V_{CE} = 5 \text{ V}; f = 1 \text{ kHz}$

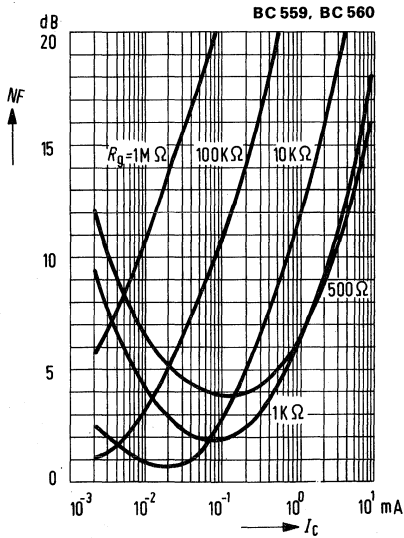

Noise figure $NF = f(I_C)$
 $V_{CE} = 5 \text{ V}; f = 120 \text{ Hz}$

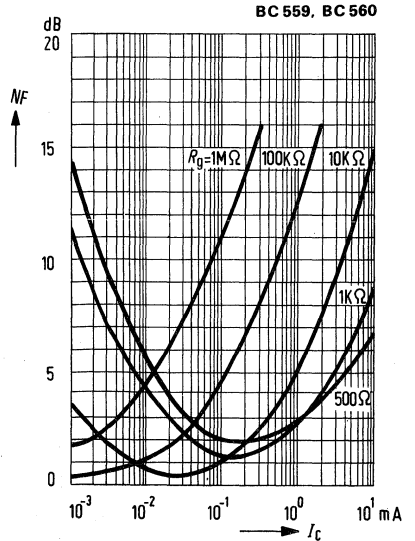

BC 617 and BC 618 are epitaxial NPN silicon planar darlington transistors in TO 92 plastic package (10 A 3 DIN 41868). These darlington transistors exhibit high current amplification and are particularly suitable for use in relay drivers and for general AF applications.

Type	Ordering code
BC 617	Q62702-C1137
BC 618	Q62702-C1138

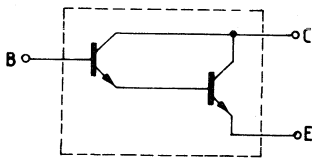

BC 617, BC 618

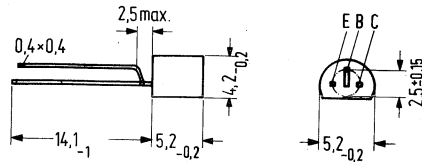

Mounting instruction: Fixing hole dia 0.6
Approx. weight 0.25 g
Dimensions in mm

Maximum ratings ($T_{amb} = 25^{\circ}\text{C}$)

Collector-emitter voltage	
Collector-base voltage	
Emitter-base voltage	
Collector current	
Junction temperature	
Storage temperature range	
Total power dissipation ($T_{amb} \leq 25^{\circ}\text{C}$)	

	BC 617	BC 618	
V_{CEO}	40	55	V
V_{CBO}	50	80	V
V_{EBO}	12	12	V
I_C	1	1	A
T_j	150	150	$^{\circ}\text{C}$
T_{stg}	-55 to +150		$^{\circ}\text{C}$
P_{tot}	625	625	mW

Thermal resistance

Junction to ambient air	R_{thJA}	≤ 200	≤ 200	K/W
Junction to case	R_{thJC}	≤ 90	≤ 90	K/W

Static characteristics ($T_{amb} = 25^{\circ}\text{C}$)

Collector cutoff current

($V_{CB} = 40\text{ V}/60\text{ V}$)

($V_{CB} = 40\text{ V}/60\text{ V}; T_{amb} = 100^{\circ}\text{C}$)

Emitter cutoff current

($V_{EB} = 10\text{ V}$)

Collector-emitter breakdown

voltage ($I_C = 10\text{ mA}$)

Collector-base breakdown voltage

Collector-emitter saturation voltage

($I_C = 200\text{ mA}; I_B = 0.2\text{ mA}$)

Base-emitter saturation voltage

($I_C = 200\text{ mA}; I_B = 0.2\text{ mA}$)

DC current gain

($I_C = 100\text{ }\mu\text{A}; V_{CE} = 5\text{ V}$)

($I_C = 10\text{ mA}; V_{CE} = 5\text{ V}$)

($I_C = 200\text{ mA}; V_{CE} = 5\text{ V}$)

($I_C = 1\text{ A}; V_{CE} = 5\text{ V}$)

	BC 617	BC 618	
I_{CBO}	<50	<50	nA
I_{CBO}	<10	<10	μA
I_{EBO}	<50	<50	nA
$V_{(BR)CEO}$	>40	>55	V
$V_{(BR)CBO}$	>50	>80	V
V_{CEsat}	<1.1	<1.1	V
V_{BEsat}	<1.6	<1.6	V
h_{FE}	>4000	>2000	-
h_{FE}	>10000	>4000	-
h_{FE}	20000-	10000-	-
	70000	50000	
h_{FE}	>10000	>4000	-

Dynamic characteristics ($T_{amb} = 25^{\circ}\text{C}$)

Transition frequency

($I_C = 500\text{ mA}; V_{CE} = 5\text{ V};$

$f = 100\text{ MHz}$)

Output capacitance

($V_{CB} = 10\text{ V}; I_E = 0; f = 1\text{ MHz}$)

Input capacitance

($V_{EB} = 5\text{ V}; I_E = 0; f = 1\text{ MHz}$)

f_T	>150	>150	MHz
C_{ob}	<4.5	<4.5	pF
C_{ib}	<5	<5	pF

Total perm. power dissipation versus temperature

$P_{tot} = f(T_{amb})$

BC 617, BC 618

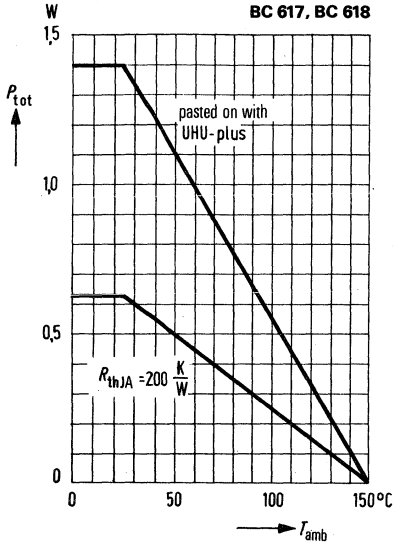

Permissible pulse load

$r_{thJA} = f(t); v = \text{parameter}$

BC 617, BC 618

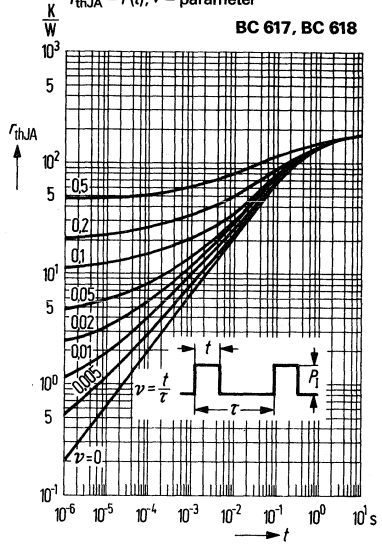

DC current gain $h_{FE} = f(I_C)$

$V_{CE} = 10 \text{ V}$

$T_{amb} = \text{parameter}$

BC 617, BC 618

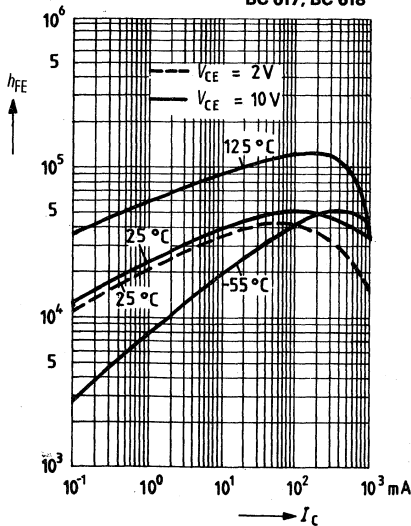

Collector emitter saturation voltage

$V_{CEsat} = f(I_C); h_{FE} = 5000$

$T_{amb} = \text{parameter}$

(common emitter configuration)

BC 617, BC 618

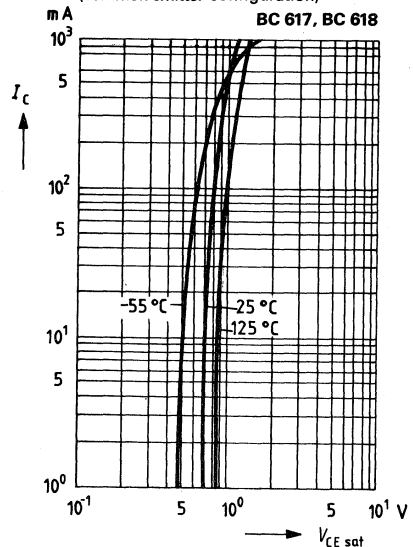

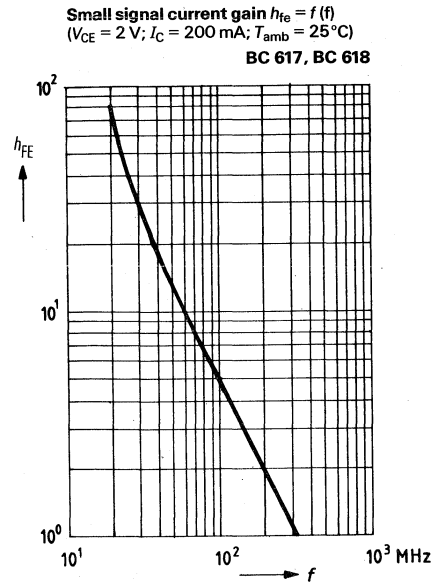
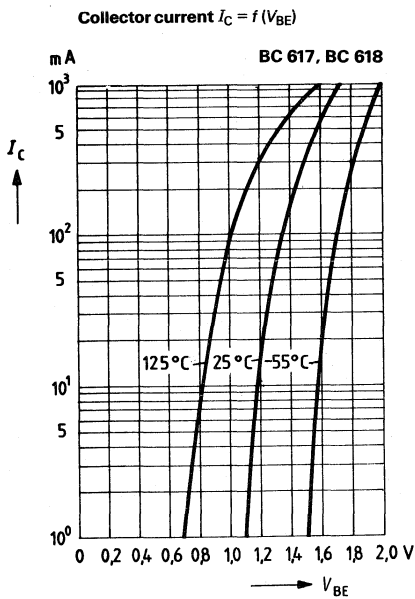
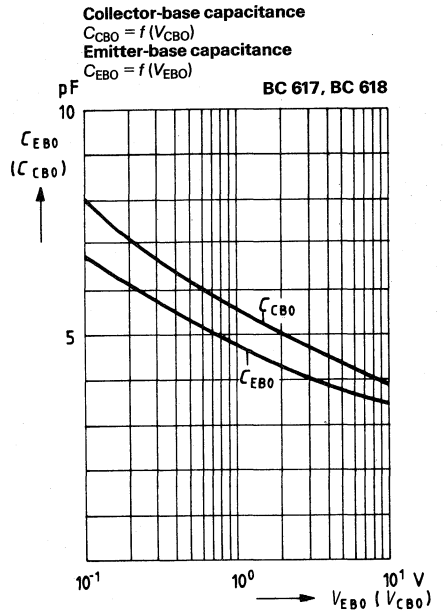
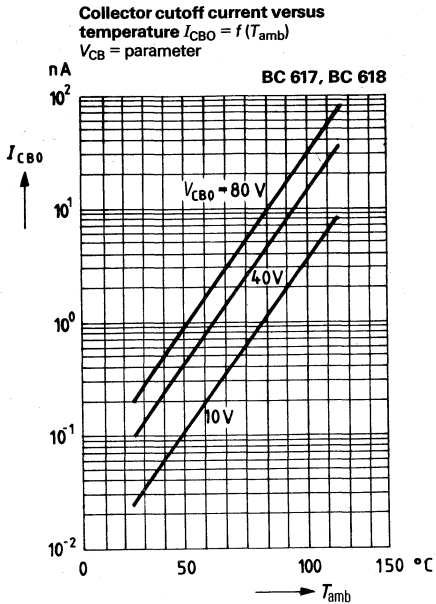

BC 635, BC 637, and BC 639 are epitaxial NPN silicon planar transistors in TO 92 plastic package (10 A 3 DIN 41 868). The transistors are suitable for use as complementary transistors to BC 636, BC 638, and BC 640.

Type	Ordering code
BC 635 ²⁾	Q68000-A3360
BC 635 paired	Q68000-A3360-P1
BC 635/BC 636 paired	Q68000-A3362-P1
BC 637 ²⁾	Q68000-A2285
BC 637 paired	Q68000-A2285-P1
BC 637/BC 638 paired	Q68000-A3363-P1
BC 639 ²⁾	Q68000-A3361
BC 639 paired	Q68000-A3361-P1
BC 639/BC 640 paired	Q68000-A3364-P1

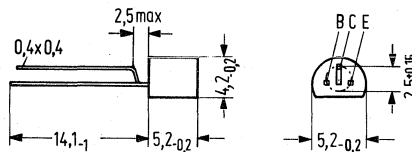

Mounting instruction:
Fixing hole dia 0.6
Approx. weight 0.25 g
Dimensions in mm

Maximum ratings

	BC 635	BC 637	BC 639	
Collector-emitter voltage ($R_{BE} = 1 \text{ k}\Omega$)	V_{CER} 45	60	100	V
Collector-emitter voltage	V_{CES} 45	60	100	V
Collector-emitter voltage	V_{CEO} 45	60	80	V
Emitter-base voltage	V_{EBO} 5	5	5	V
Collector current	I_C 1	1	1	A
Collector peak current	I_{CM} 1.5	1.5	1.5	A
Base current	I_B 100	100	100	mA
Junction temperature	T_j 150	150	150	°C
Storage temperature range	T_{stg}	-65 to +150		°C
Total power dissipation ¹⁾ ($T_{amb} = 25^\circ\text{C}$)	P_{tot} 0.8 (1)	0.8 (1)	0.8 (1)	W

Thermal resistance

Junction to ambient air ¹⁾	R_{thJA}	156	156	156	K/W
Junction to case	R_{thJC}	55	55	55	K/W

1) If the transistors with max 3 mm lead length are fixed on PCBs with a min. 10 mm x 10 mm large copper area for the collector terminal, $R_{thJA} = 125 \text{ K/W}$ and thus $P_{tot \text{ max}} (T_{amb} = 25^\circ\text{C}) = 1 \text{ W}$

2) If the order does not include any exact indication of the current amplification group desired, a transistor of a current amplification group just available from stock will be delivered.

Static characteristics ($T_{amb} = 25^{\circ}\text{C}$)		BC 635	BC 637	BC 639	
Collector-emitter saturation voltage ($I_C = 500\text{ mA}$, $I_B = 50\text{ mA}$)	V_{CEsat}	≤ 0.5	≤ 0.5	≤ 0.5	V
Collector cutoff current ($V_{CB} = 30\text{ V}$)	I_{CBO}	≤ 100	≤ 100	≤ 100	nA
Collector cutoff current ($V_{CB} = 30\text{ V}$, $T_{amb} = 125^{\circ}\text{C}$)	I_{CBO}	≤ 10	≤ 10	≤ 10	μA
Emitter cutoff current ($V_{EB} = 5\text{ V}$)	I_{EBO}	≤ 10	≤ 10	≤ 10	μA
Base-emitter voltage ($V_{CE} = 2\text{ V}$, $I_C = 500\text{ mA}$)	V_{BE}	≤ 1	≤ 1	≤ 1	V
Collector-emitter breakdown voltage ($I_{CEO} = 10\text{ mA}$)	$V_{(BR)CEO}$	45	60	80	V
DC current gain					
$I_C = 5\text{ mA}$, $V_{CE} = 2\text{ V}$	h_{FE}	> 25	> 25	> 25	-
$I_C = 150\text{ mA}$, $V_{CE} = 2\text{ V}$	h_{FE}	40-250	40-160	40-160	-
$I_C = 500\text{ mA}$, $V_{CE} = 2\text{ V}$	h_{FE}	> 25	> 25	> 25	-
Condition for matching pairs ($I_C = 150\text{ mA}$; $V_{CE} = 2\text{ V}$)	$\frac{h_{FE1}}{h_{FE2}}$	1.3 (< 1.6)	1.3 (< 1.6)	1.3 (< 1.6)	-

Dynamic characteristics ($T_{amb} = 25^{\circ}\text{C}$)

Transition frequency $V_{CE} = 5\text{ V}$, $I_C = 10\text{ mA}$	f_T	130	130	130	MHz
--	-------	-----	-----	-----	-----

Total perm. power dissipation versus temperature

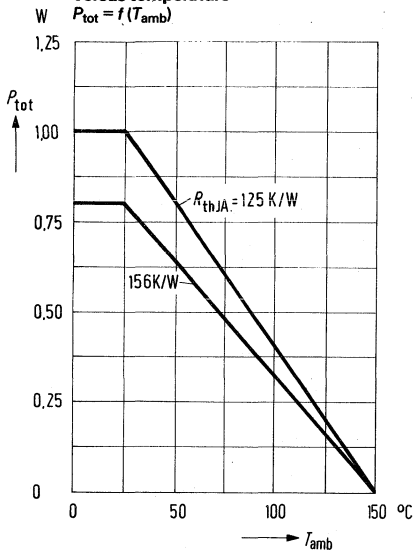

DC current gain $h_{FE} = f(I_C)$;
 $V_{CE} = 2 \text{ V}$

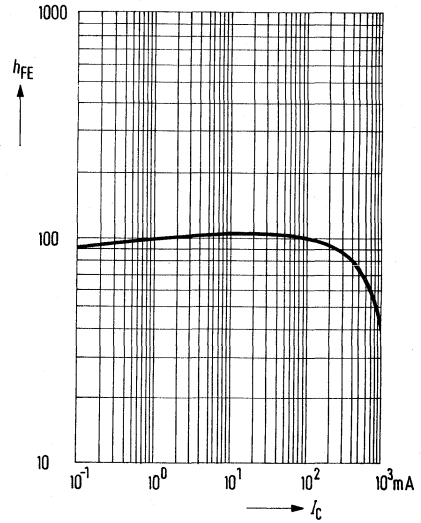

Output characteristics $I_C = f(V_{CE})$
 $I_B = \text{parameter}$

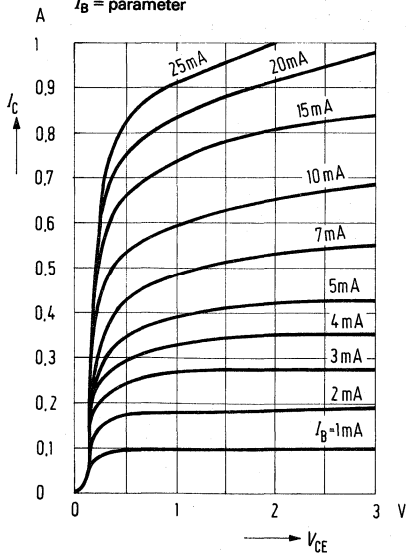

Output characteristics $I_C = f(V_{CE})$
 $I_B = \text{parameter}$

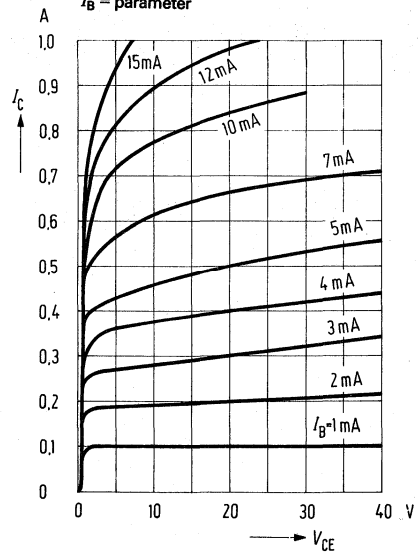

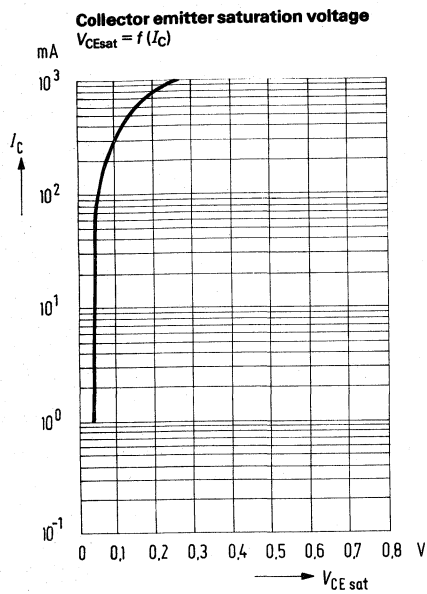
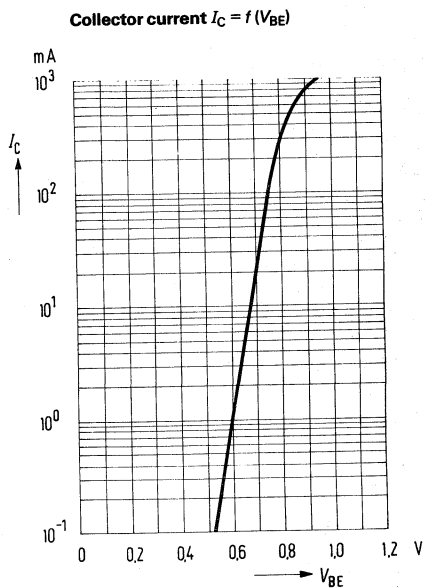

BC 636, BC 638, and BC 640 are epitaxial PNP silicon planar transistors in TO 92 plastic package (10 A 3 DIN 41 868). The transistors are suitable for use as complementary transistors to BC 635, BC 637, and BC 639.

Type	Ordering code
BC 636 ²⁾	Q68000-A3365
BC 636 paired	Q68000-A3365-P1
BC 636/BC 635 paired	Q68000-A3362-P1
BC 638 ²⁾	Q68000-A3366
BC 638 paired	Q68000-A3366-P1
BC 638/BC 637 paired	Q68000-A3363-P1
BC 640 ²⁾	Q68000-A3367
BC 640 paired	Q68000-A3367-P1
BC 640/BC 639 paired	Q68000-A3364-P1

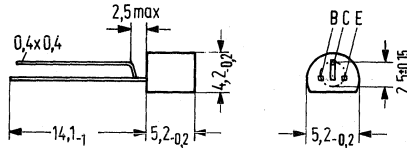

Mounting instruction:
Fixing hole dia 0.6
Approx. weight 0.25 g
Dimensions in mm

Maximum ratings

		BC 636	BC 638	BC 640	
Collector-emitter voltage ($R_{BE} = 1\text{ k}\Omega$)	$-V_{CER}$	45	60	100	V
Collector-emitter voltage	$-V_{CES}$	45	60	100	V
Collector-emitter voltage	$-V_{CEO}$	45	60	80	V
Emitter-base voltage	$-V_{EBO}$	5	5	5	V
Collector current	$-I_C$	1	1	1	A
Collector peak current	$-I_{CM}$	1.5	1.5	1.5	A
Base current	$-I_B$	100	100	100	mA
Junction temperature	T_j	150	150	150	$^{\circ}\text{C}$
Storage temperature range	T_{stg}	-65 to +150			$^{\circ}\text{C}$
Total power dissipation ¹⁾ ($T_{amb} = 25^{\circ}\text{C}$)	P_{tot}	0.8 (1)	0.8 (1)	0.8 (1)	W

Thermal resistance

Junction to ambient air ¹⁾	R_{thJA}	156	156	156	K/W
Junction to case	R_{thJC}	55	55	55	K/W

- 1) If the transistors with max. 3 mm lead length are fixed on PCBs with a min. 10 mm x 10 mm large copper area for the collector terminal, $R_{thJA} = 125\text{ K/W}$ and thus $P_{tot\text{ max}}$ ($T_{amb} = 25^{\circ}\text{C}$) = 1 W.
- 2) If the order does not include any exact indication of the current amplification group desired, a transistor of a current amplification group just available from stock will be delivered.

Static characteristics ($T_{amb} = 25^{\circ}\text{C}$)		BC 636	BC 638	BC 640	
Collector-emitter saturation voltage ($-I_C = 500\text{ mA}$, $-I_B = 50\text{ mA}$)	$-V_{CEsat}$	≤ 0.5	≤ 0.5	≤ 0.5	V
Collector cutoff current ($-V_{CB} = 30\text{ V}$)	$-I_{CBO}$	≤ 100	≤ 100	≤ 100	nA
Collector cutoff current ($-V_{CB} = 30\text{ V}$, $T_j = 125^{\circ}\text{C}$)	$-I_{CBO}$	≤ 10	≤ 10	≤ 10	μA
Emitter cutoff current ($-V_{EB} = 5\text{ V}$)	$-I_{EBO}$	≤ 10	≤ 10	≤ 10	μA
Base-emitter voltage ($-V_{CE} = 2\text{ V}$, $-I_C = 500\text{ mA}$)	$-V_{BE}$	≤ 1	≤ 1	≤ 1	V
Collector-emitter breakdown voltage ($-I_{CEO} = 10\text{ mA}$)	$V_{(BR)CEO}$	45	60	80	V
DC current gain					
$-I_C = 5\text{ mA}$, $-V_{CE} = 2\text{ V}$	h_{FE}	> 25	> 25	> 25	-
$-I_C = 150\text{ mA}$, $-V_{CE} = 2\text{ V}$	h_{FE}	40-250	40-160	40-160	-
$-I_C = 500\text{ mA}$, $-V_{CE} = 2\text{ V}$	h_{FE}	> 25	> 25	> 25	-
Condition for matching pairs ($I_C = 150\text{ mA}$; $V_{CE} = 2\text{ V}$)	$\frac{h_{FE1}}{h_{FE2}}$	1.3 (< 1.6)	1.3 (< 1.6)	1.3 (< 1.6)	-

Dynamic characteristics ($T_{amb} = 25^{\circ}\text{C}$)

Transition frequency $-V_{CE} = 5\text{ V}$, $-I_C = 10\text{ mA}$	f_T	130	130	130	MHz
--	-------	-----	-----	-----	-----

Total perm. power dissipation versus temperature
 $P_{tot} = f(T_{amb})$

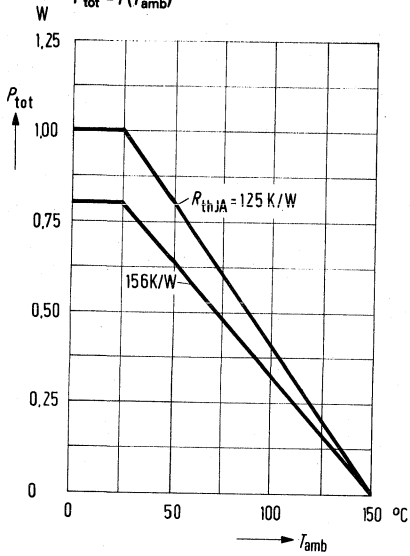

DC current gain $h_{FE} = f(I_C)$;
 $-V_{CE} = 2 \text{ V}$

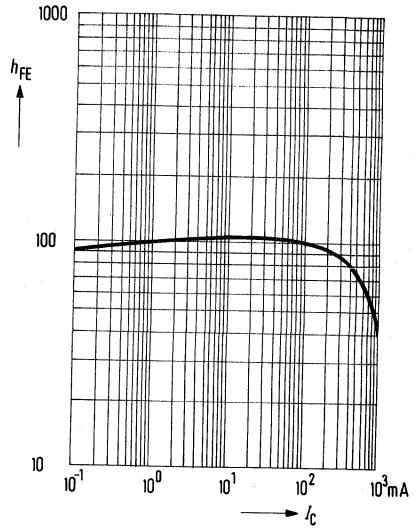

Output characteristics $I_C = f(V_{CE})$
 $I_B = \text{parameter}$

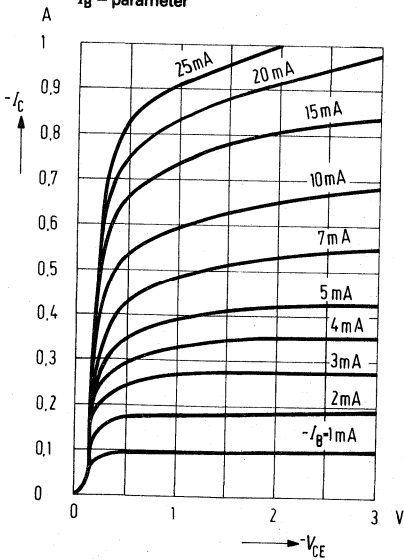

Output characteristics $I_C = f(V_{CE})$
 $I_B = \text{parameter}$

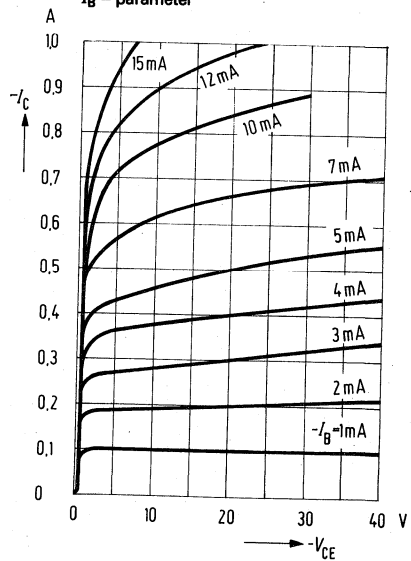

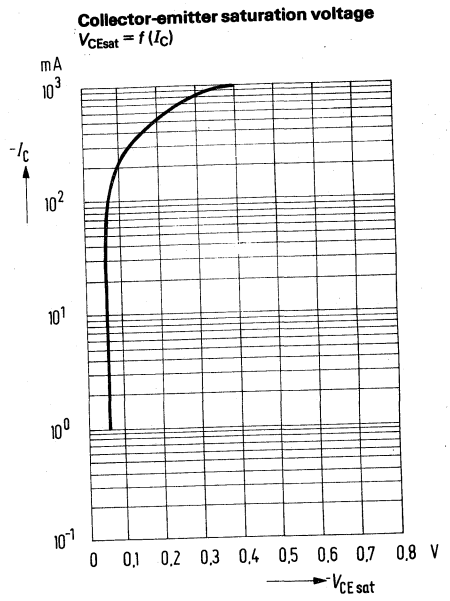
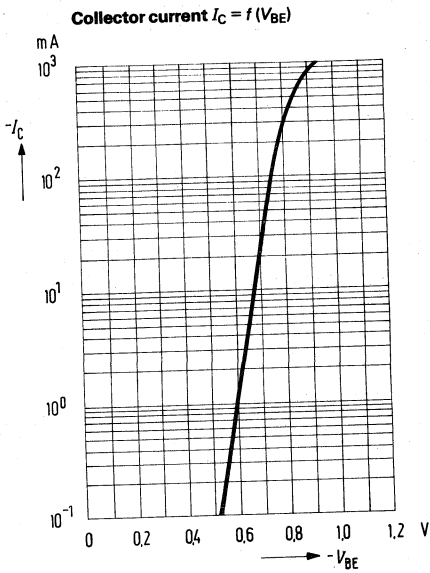

BC 875, BC 877, and BC 879 are epitaxial NPN silicon planar darlington transistors with integrated diode and resistor in TO 92 plastic package (10 A 3 DIN 41 868). These transistors are particularly suitable for use as relay driver and for general AF applications.

Complementary transistors to these types are BC 876, BC 878, and BC 880.

Type	Ordering code
BC 875	Q62702-C853
BC 877	Q62702-C854
BC 879	Q62702-C855

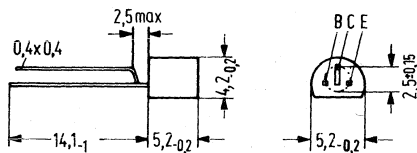

Mounting instruction: Fixing hole dia 0.6

Approx. weight 0.25 g

Dimensions in mm

Maximum ratings ($T_{amb} = 25^{\circ}\text{C}$)

	BC 875	BC 877	BC 879		
Collector-emitter voltage	V_{CEO}	45	60	80	V
Collector-base voltage	V_{CBO}	60	80	100	V
Emitter-base voltage	V_{EBO}	5	5	5	V
Collector current	I_C	1	1	1	A
Collector peak current	I_{CM}	2	2	2	A
Base current	I_B	0.1	0.1	0.1	A
Junction temperature	T_j	150	150	150	$^{\circ}\text{C}$
Storage temperature range	T_{stg}	-65 to +150		$^{\circ}\text{C}$	
Total power dissipation ¹⁾ ($T_{amb} \leq 25^{\circ}\text{C}$)	P_{tot}	0.8 (1)	0.8 (1)	0.8 (1)	W

Thermal resistance

Junction to ambient air ¹⁾	R_{thJA}	<156	<156	<156	K/W
Junction to case	R_{thJC}	<55	<55	<55	K/W

1) If the transistors with max 3 mm lead length are fixed on PCBs with a min. 10 mm x 10 mm large copper area for the collector terminal, $R_{thJA} = 125 \text{ K/W}$ and thus $P_{tot \text{ max}} (T_{amb} = 25^{\circ}\text{C}) = 1 \text{ W}$.

Static characteristics ($T_{amb} = 25^{\circ}\text{C}$)		BC 875	BC 877	BC 879	
Collector cutoff current ($V_{CB} = V_{CBmax}$)	I_{CBO}	<100	<100	<100	nA
Collector cutoff current ($V_{CE} = 0.5 V_{CEmax}$)	I_{CEO}	<500	<500	<500	nA
Emitter cutoff current ($V_{EB} = 4\text{ V}$)	I_{EBO}	<100	<100	<100	nA
Collector-emitter breakdown voltage ($I_C = 50\text{ mA}$)	$V_{(BR)CEO}$	>45	>60	>80	V
Collector-base breakdown voltage ($I_C = 100\text{ }\mu\text{A}$)	$V_{(BR)CBO}$	>60	>80	>100	V
Emitter-base breakdown voltage ($I_E = 100\text{ }\mu\text{A}$)	$V_{(BR)EBO}$	>5	>5	>5	V
DC current gain ($I_C = 150\text{ mA}$; $V_{CE} = 10\text{ V}$)	h_{FE}	>1000	>1000	>1000	-
($I_C = 0.5\text{ A}$; $V_{CE} = 10\text{ V}$)	h_{FE}	>2000	>2000	>2000	-
Collector-emitter saturation voltage ($I_C = 0.5\text{ A}$; $I_B = 0.5\text{ mA}$)	V_{CEsat}	<1.3	<1.3	<1.3	V
($I_C = 1\text{ A}$; $I_B = 1\text{ mA}$)	V_{CEsat}	<1.8	<1.8	<1.8	V
Base-emitter saturation voltage ($I_C = 1\text{ A}$; $I_B = 1\text{ mA}$)	V_{BEsat}	<2.2	<2.2	<2.2	V

Dynamic characteristics ($T_{amb} = 25^{\circ}\text{C}$)

Transition frequency ($I_C = 0.5\text{ A}$; $V_{CE} = 5\text{ V}$; $f = 35\text{ MHz}$)	f_T	200	200	200	MHz
--	-------	-----	-----	-----	-----

Total perm. power dissipation versus temperature

$P_{tot} = f(T_{amb})$

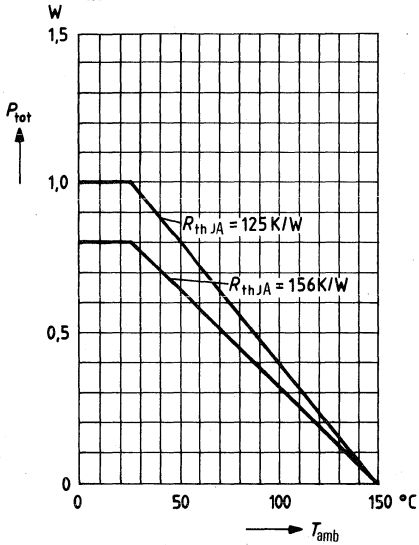

Permissible pulse load $r_{thJA} = f(t)$

$\frac{Z_{th}}{R_{th}} = f(\tau)$

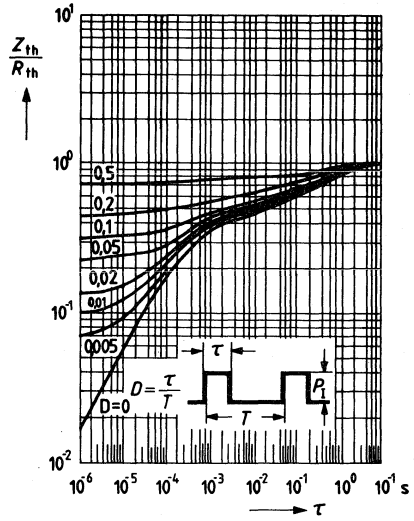

DC current gain $h_{FE} = f(T_{amb})$

$V_{CE} = 10 \text{ V}; I_C = \text{parameter}$

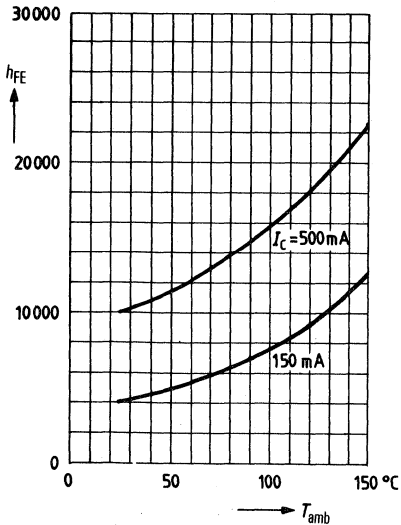

Collector current $I_C = f(V_{BE})$

$V_{CE} = 10 \text{ V}$

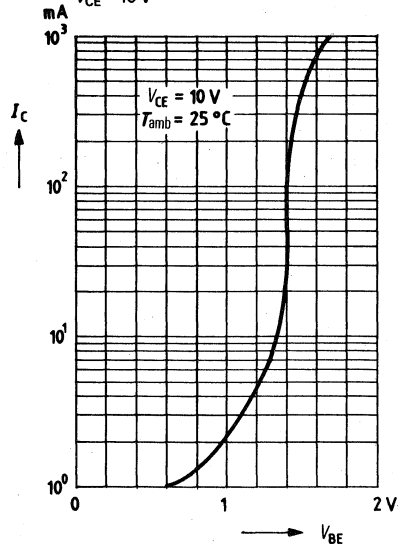

Collector-emitter saturation voltage

$V_{CEsat} = f(I_C)$

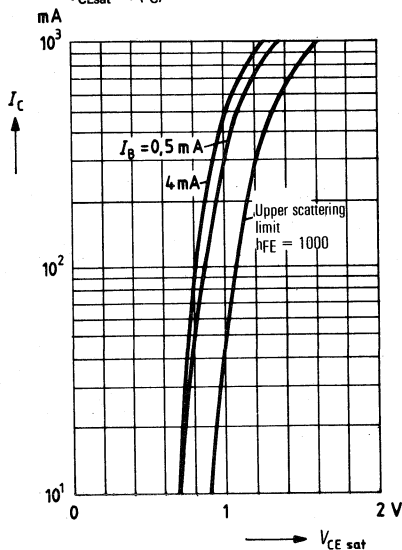

Base-emitter saturation voltage

$V_{BEsat} = f(I_C)$

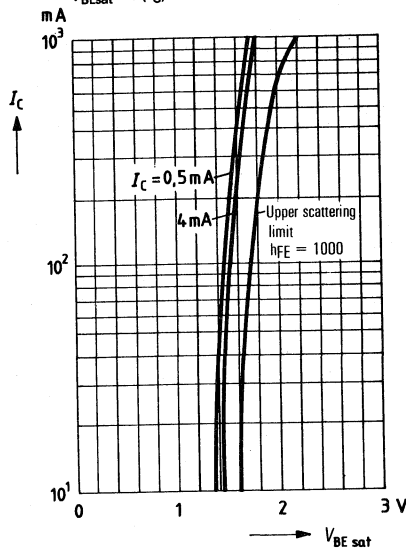

DC current gain $h_{FE} = f(I_C)$

$V_{CE} = 10 \text{ V}$

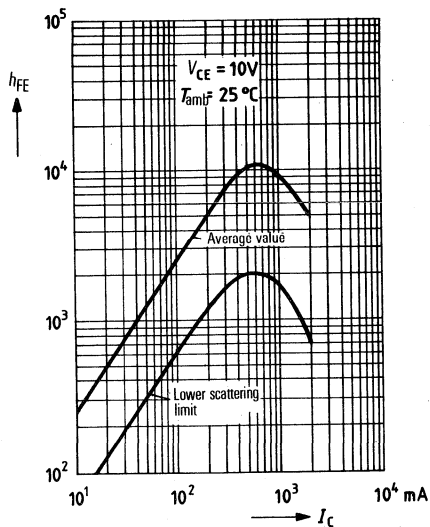

Small signal current gain $h_{fe} = f(I_C)$

$V_{CE} = 5 \text{ V}; f = 35 \text{ MHz}$

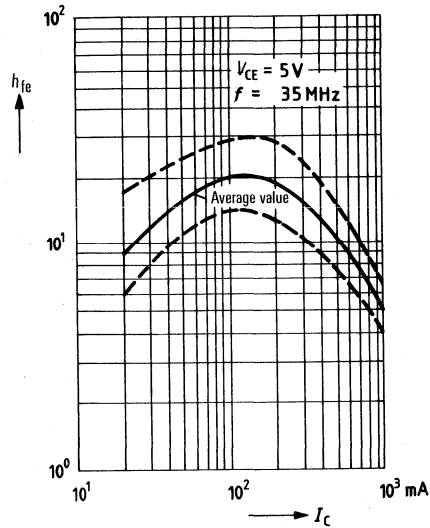

BC 876, BC 878, and BC 880 are epitaxial PNP silicon darlington transistors with integrated diode and resistor in TO 92 plastic package (10 A 3 DIN 41868). These transistors are particularly suitable for use as relay driver and for general AF applications. Complementary transistors to these types are BC 875, BC 877, and BC 879.

Type	Ordering code
BC 876	Q62702-C943
BC 878	Q62702-C942
BC 880	Q62702-C941

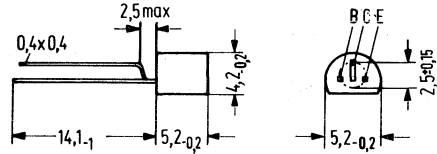
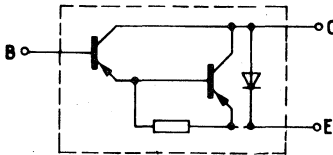

Mounting instruction: Fixing hole dia 0.6
 Approx. weight 0.25 g
 Dimensions in mm

Maximum ratings ($T_{amb} = 25^{\circ}\text{C}$)

	BC 876	BC 878	BC 880	
Collector-emitter voltage	$-V_{CEO}$ 45	60	80	V
Collector-base voltage	$-V_{CBO}$ 60	80	100	V
Emitter-base voltage	$-V_{EBO}$ 5	5	5	V
Collector current	$-I_C$ 1	1	1	A
Collector peak current	$-I_{CM}$ 2	2	2	A
Base current	$-I_B$ 0.1	0.1	0.1	A
Junction temperature	T_j 150	150	150	$^{\circ}\text{C}$
Storage temperature range	T_{stg}	-65 to +150		$^{\circ}\text{C}$
Total power dissipation ¹⁾ ($T_{amb} \leq 25^{\circ}\text{C}$)	P_{tot} 0.8 (1)	0.8 (1)	0.8 (1)	W

Thermal resistance

Junction to ambient air ¹⁾	R_{thJA}	<156	<156	<156	K/W
Junction to case	R_{thJC}	<55	<55	<55	K/W

1) If the transistors with max. 3 mm lead length are fixed on PCBs with a min. 10 mm x 10 mm large copper area for the collector terminal, $R_{thJA} = 125 \text{ K/W}$ and thus $P_{tot \text{ max}} (T_{amb} = 25^{\circ}\text{C}) = 1 \text{ W}$.

Static characteristics ($T_{amb} = 25^{\circ}\text{C}$)

	BC 876	BC 878	BC 880		
Collector cutoff current ($-V_{CB} = V_{CBmax}$)	$-I_{CBO}$	< 100	< 100	< 100	nA
Collector cutoff current ($-V_{CE} = 0.5 V_{CEmax}$)	$-I_{CEO}$	< 500	< 500	< 500	nA
Emitter cutoff current ($-V_{EB} = 4 \text{ V}$)	$-I_{EBO}$	< 100	< 100	< 100	nA
Collector-emitter breakdown voltage ($-I_C = 50 \text{ mA}$)	$-V_{(BR)CEO}$	> 45	> 60	> 80	V
Collector-base breakdown voltage ($-I_C = 100 \mu\text{A}$)	$-V_{(BR)CBO}$	> 60	> 80	> 100	V
Emitter-base breakdown voltage ($I_E = 100 \mu\text{A}$)	$-V_{(BR)EBO}$	> 5	> 5	> 5	V
DC current gain ($-I_C = 150 \text{ mA}$; $-V_{CE} = 10 \text{ V}$)	h_{FE}	> 1000	> 1000	> 1000	-
($-I_C = 0.5 \text{ A}$; $-V_{CE} = 10 \text{ V}$)	h_{FE}	> 2000	> 2000	> 2000	-
Collector-emitter saturation voltage ($-I_C = 0.5 \text{ A}$; $-I_B = 0.5 \text{ mA}$)	$-V_{CEsat}$	< 1.3	< 1.3	< 1.3	V
($-I_C = 1 \text{ A}$; $-I_B = 1 \text{ mA}$)	$-V_{CEsat}$	< 1.8	< 1.8	< 1.8	V
Base-emitter saturation voltage ($-I_C = 1 \text{ A}$; $-I_B = 1 \text{ mA}$)	$-V_{BEsat}$	< 2.2	< 2.2	< 2.2	V

Dynamic characteristics ($T_{amb} = 25^{\circ}\text{C}$)

Transition frequency ($-I_C = 0.5 \text{ A}$; $-V_{CE} = 5 \text{ V}$; $f = 35 \text{ MHz}$)	f_T	200	200	200	MHz
--	-------	-----	-----	-----	-----

Total perm. power dissipation versus temperature
 $P_{tot} = f(T_{amb})$

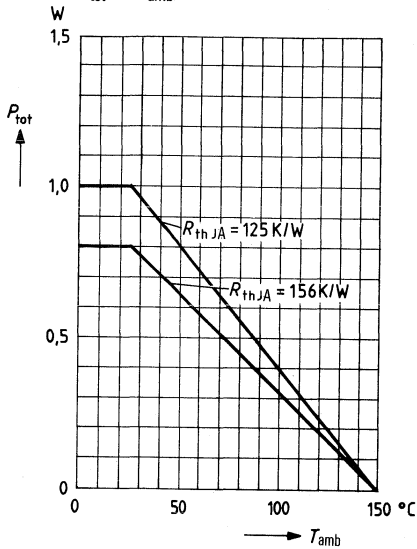

Permissible pulse load
 $\frac{Z_{th}}{R_{th}} = f(\tau)$

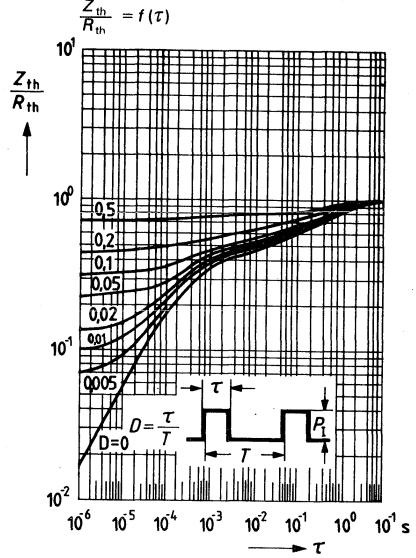

DC current gain $h_{FE} = f(T_{amb})$
 $-I_C$ = parameter; $-V_{CE} = 10 \text{ V}$

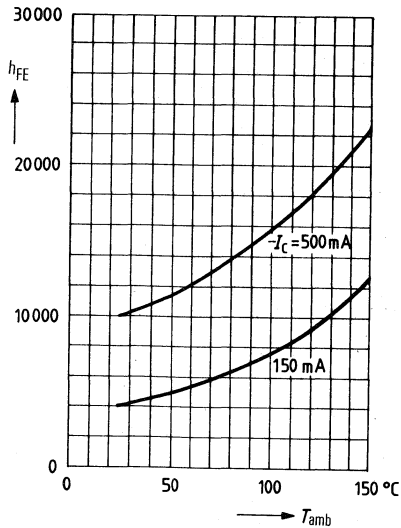

Collector current $I_C = f(V_{BE})$
 $-V_{CE} = 10 \text{ V}$

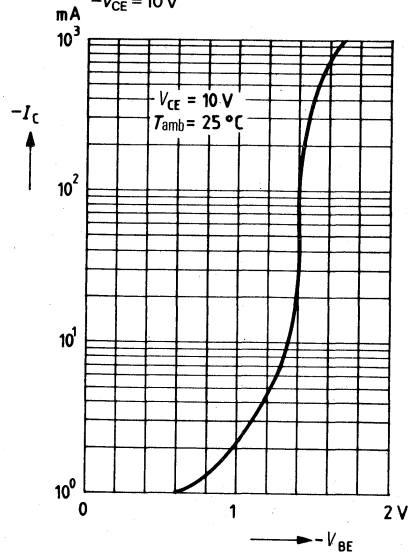

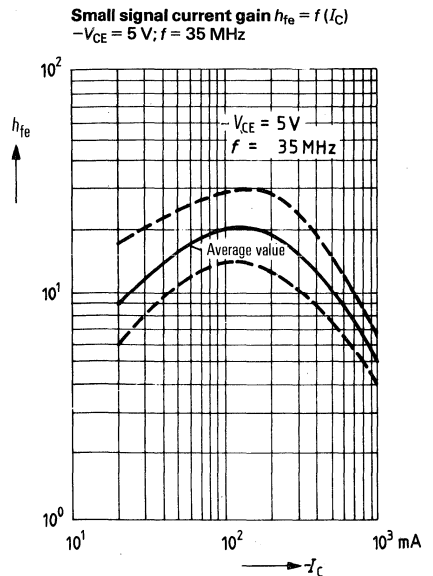
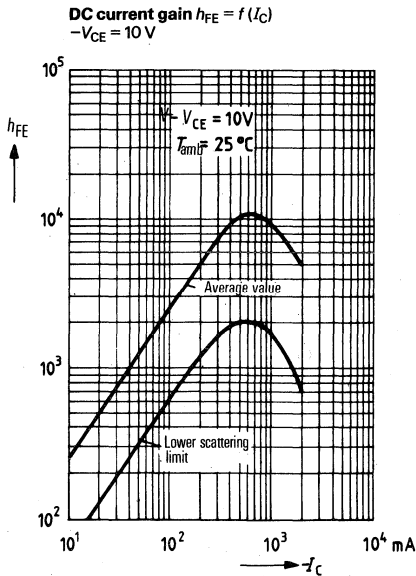
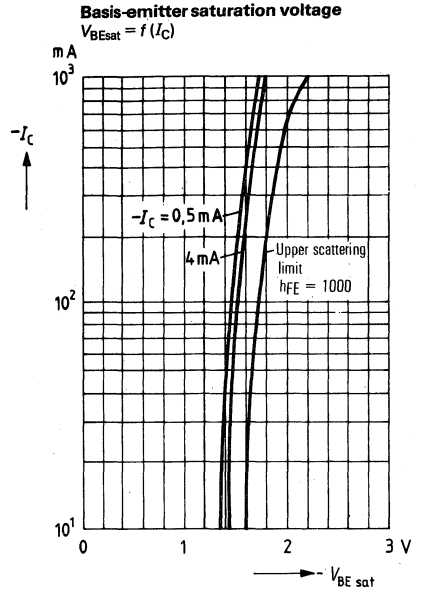
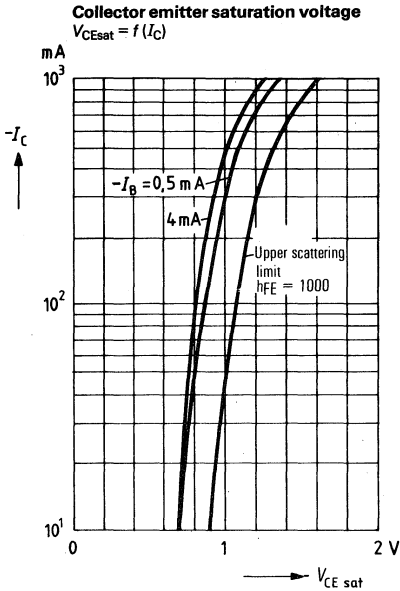

BCV 26 and BCV 46 are epitaxial PNP silicon planar darlington transistors in TO 236 plastic packages (23 A 3 DIN 41869). They exhibit particularly high current amplification. Owing to their high voltage and current carrying capacity, they are suitable for use as relay drivers, as complementary drivers for power output stages as well as for highly amplifying stages in general AF applications.

They are complementary transistors to BCV 27 and BCV 47.

Type	Mark	Ordering code
BCV 26	FD	Q62702-C1151
BCV 46	FE	Q62702-C1153

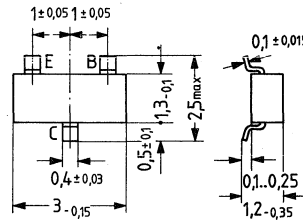
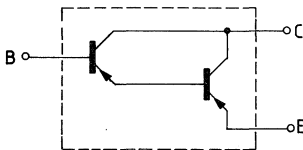

Approx. weight 0.02 g
Dimensions in mm

Maximum ratings

	BCV 26	BCV 46	
Collector-emitter voltage	$-V_{CEO}$ 30	60	V
Collector-base voltage	$-V_{CBO}$ 40	80	V
Emitter-base voltage	$-V_{EBO}$ 10	10	V
Collector current	$-I_C$ 500	500	mA
Collector peak current	$-I_{CM}$ 800	800	mA
Base current	$-I_B$ 100	100	mA
Junction temperature	T_j 150	150	°C
Storage temperature range	T_{stg} -55 to +125	-55 to +125	°C
Total power dissipation ($T_{amb} \leq 25^\circ\text{C}$)	P_{tot} 350	350	mW

Thermal resistance

Junction to ambient air	R_{thJA}	≤ 358	≤ 358	K/W
Junction to substrate back ¹⁾	R_{thJSB}	≤ 250	≤ 260	K/W

1) Ceramic substrate 0.7 mm, 2.5 cm² area

Static characteristics ($T_{amb} = 25^{\circ}\text{C}$)

Collector cutoff current

($-V_{CBO} = 30\text{ V}$)

($-V_{CBO} = 60\text{ V}$)

Emitter cutoff current

($-V_{EB} = 10\text{ V}$)

Collector-emitter breakdown voltage

($-I_C = 10\text{ mA}$)

Collector-base breakdown voltage

($-I_C = 10\text{ }\mu\text{A}$)

Emitter-base breakdown voltage

($-I_E = 100\text{ nA}$)

Collector-emitter saturation voltage

($-I_C = 100\text{ mA}$; $-I_B = 0.1\text{ mA}$)

Base-emitter saturation voltage

($-I_C = 100\text{ mA}$; $-I_B = 0.1\text{ mA}$)

DC current gain

($-I_C = 100\text{ }\mu\text{A}$; $-V_{CE} = 5\text{ V}$)

($-I_C = 10\text{ mA}$; $-V_{CE} = 5\text{ V}$)

($-I_C = 100\text{ mA}$; $-V_{CE} = 5\text{ V}$)

($-I_C = 0.5\text{ A}$; $-V_{CE} = 5\text{ V}$)

	BCV 26	BCV 46	
$-I_{CBO}$	< 100	—	nA
$-I_{CBO}$	—	< 100	nA
$-I_{EBO}$	< 100	< 100	nA
$-V_{(BR)CEO}$	> 30	> 60	V
$-V_{(BR)CBO}$	> 40	> 80	V
$-V_{(BR)EBO}$	> 10	> 10	V
$-V_{CEsat}$	< 1	< 1	V
$-V_{BEsat}$	< 1.5	< 1.5	V
h_{FE}	> 4000	> 2000	—
h_{FE}	> 10000	> 4000	—
h_{FE}	> 20000	> 10000	—
h_{FE}	> 4000	> 2000	—

Dynamic characteristics ($T_{amb} = 25^{\circ}\text{C}$)

Transition frequency

($-I_C = 10\text{ mA}$; $-V_{CE} = 5\text{ V}$; $f = 100\text{ MHz}$)

Output capacitance

($-V_{CB} = 10\text{ V}$; $I_E = 0$)

f_T	200	200	MHz
C_{ob}	3.5	3.5	pF

Total perm. power dissipation versus temperature
 $P_{tot} = f(T_{amb})$

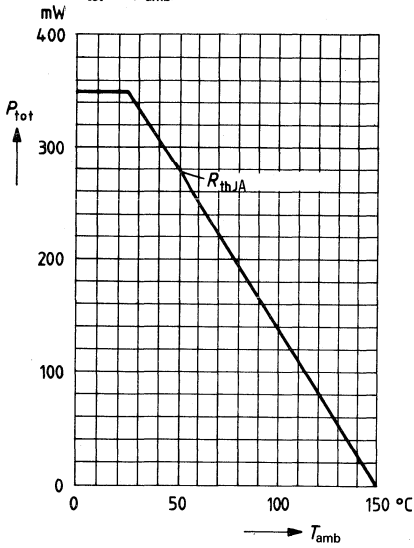

Pulse resistance $\frac{r_{thJSB}}{R_{thJSB}} = f(t)$
 $D = \text{parameter}$

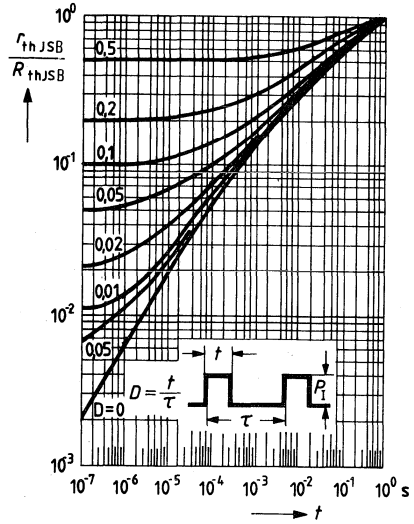

Collector current $I_C = f(V_{BE})$

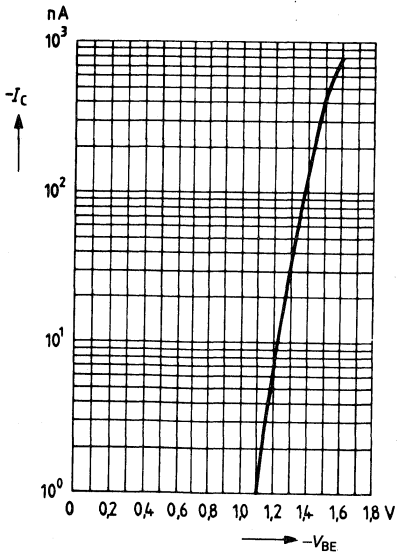

Collector-cutoff current versus temperature $I_{CES} = f(T_{amb})$

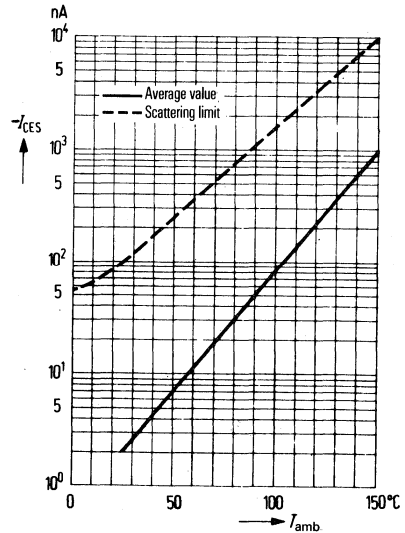

Collector emitter saturation voltage

$V_{CEsat} = f(I_C)$

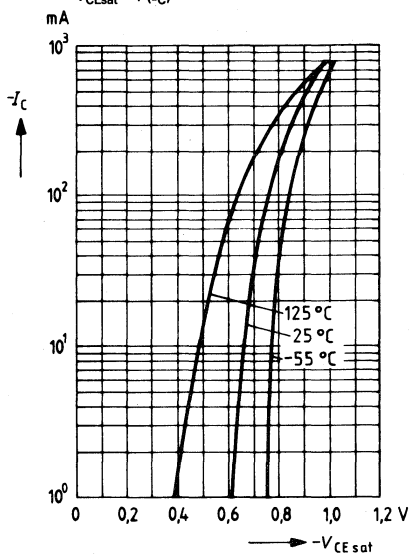

Base-emitter saturation voltage

$V_{BEsat} = f(I_C)$

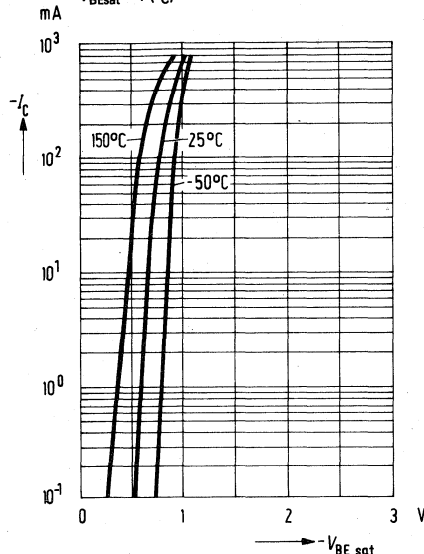

DC current gain $h_{FE} = f(I_C)$

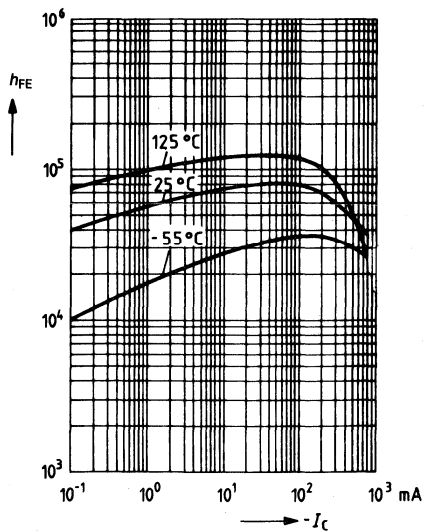

Collector-base capacitance $C_{CBO} = f(V_{CBO})$
Emitter-base capacitance $C_{EBO} = f(V_{EBO})$

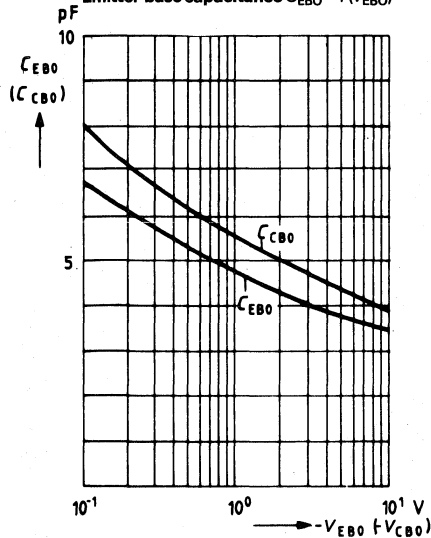

NPN Silicon Planar Darlington Transistors for Film Circuits

BCV 27
BCV 47

BCV 27 and BCV 47 are epitaxial NPN silicon planar darlington transistors in TO 236 plastic packages (23 A 3 DIN 41869). They exhibit particularly high current amplification. Owing to their high voltage and current carrying capacity, they are suitable for use as relay drivers, as complementary drivers for power output stages as well as for highly amplifying stages in general AF applications.

They are complementary transistors to BCV 26 and BCV 46.

Type	Mark	Ordering code
BCV 27	FF	Q62702-C1152
BCV 47	FG	Q62702-C1154

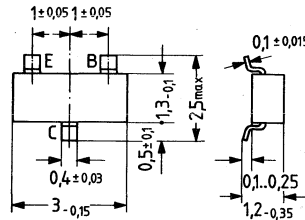
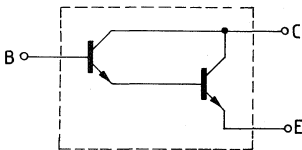

Approx. weight 0.02 g

Dimensions in mm

Maximum ratings

Collector-emitter voltage
Collector-base voltage
Base-emitter voltage
Collector current
Collector peak current
Base current
Storage temperature range
Junction temperature
Total power dissipation ($T_{amb} \leq 25^\circ\text{C}$)

	BCV 27	BCV 47	
V_{CEO}	30	60	V
V_{CBO}	40	80	V
V_{EBO}	10	10	V
I_C	500	500	mA
I_{CM}	800	800	mA
I_B	100	100	mA
T_{stg}	-55 to +125	-55 to +125	$^\circ\text{C}$
T_j	150	150	$^\circ\text{C}$
P_{tot}	350	350	mW

Thermal resistance

Junction to ambient air
Junction to substrate back ¹⁾

R_{thJA}	≤ 358	≤ 358	K/W
R_{thJSB}	≤ 260	≤ 260	K/W

1) Ceramic substrate 0.7 mm; 2.5 cm² area

Static characteristics ($T_{amb} = 25^{\circ}\text{C}$)

Collector cutoff current

($V_{CBO} = 30$)

($V_{CBO} = 60$)

Emitter cutoff current

($V_{EB} = 10\text{ V}$)

Collector-emitter breakdown voltage

($I_C = 10\text{ mA}$)

Collector-base breakdown voltage

($I_C = 10\text{ }\mu\text{A}$)

Emitter-base breakdown voltage

($I_E = 100\text{ nA}$)

DC current gain

($I_C = 100\text{ }\mu\text{A}$; $V_{CE} = 5\text{ V}$)

($I_C = 10\text{ mA}$; $V_{CE} = 5\text{ V}$)

($I_C = 100\text{ mA}$; $V_{CE} = 5\text{ V}$)

($I_C = 0.5\text{ A}$; $V_{CE} = 5\text{ V}$)

Collector-emitter saturation voltage

($I_C = 100\text{ mA}$; $I_B = 0.1\text{ mA}$)

Base-emitter saturation voltage

($I_C = 100\text{ mA}$; $I_B = 0.1\text{ mA}$)

	BCV 27	BCV 47	
I_{CBO}	< 100	–	nA
I_{CBO}	–	< 100	nA
I_{EBO}	< 100	< 100	nA
$V_{(BR)CEO}$	> 30	> 60	V
$V_{(BR)CBO}$	> 40	> 80	V
$V_{(BR)EBO}$	> 10	> 10	V
h_{FE}	> 4000	> 2000	–
h_{FE}	> 10000	> 4000	–
h_{FE}	> 20000	> 10000	–
h_{FE}	> 4000	> 2000	–
V_{CEsat}	< 1	< 1	V
V_{BEsat}	< 1.5	< 1.5	V

Dynamic characteristics ($T_{amb} = 25^{\circ}\text{C}$)

Transition frequency

($I_C = 10\text{ mA}$; $V_{CE} = 5\text{ V}$; $f = 100\text{ MHz}$)

Output capacitance

($V_{CB} = 10\text{ V}$; $I_E = 0$)

f_T	200	200	MHz
C_{ob}	3.5	3.5	pF

Total perm. power dissipation versus temperature
 $P_{tot} = f(T_{amb})$

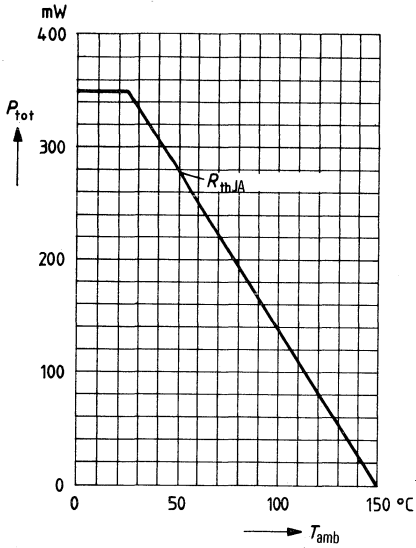

Pulse resistance $\frac{r_{thJSB}}{R_{thJSB}} = f(t)$
 $D = \text{parameter}$

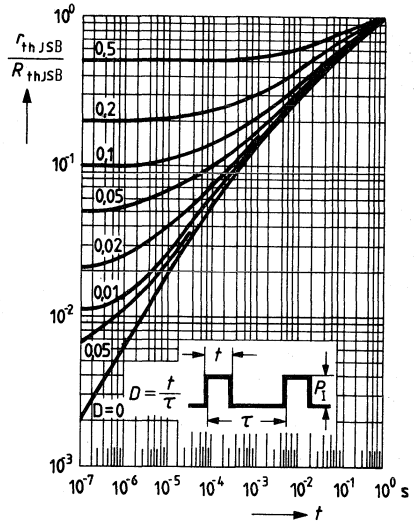

Collector current $I_C = f(V_{BE})$

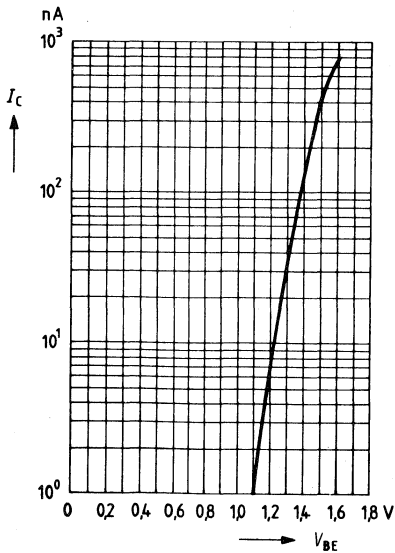

Collector cutoff current versus temperature
 $I_{CES} = f(T_{amb})$

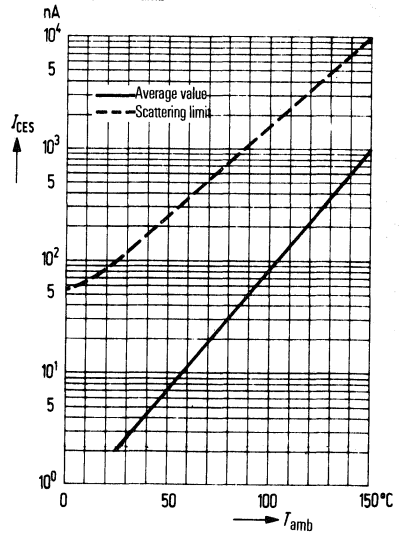

Collector-emitter saturation voltage

$V_{CEsat} = f(I_C)$

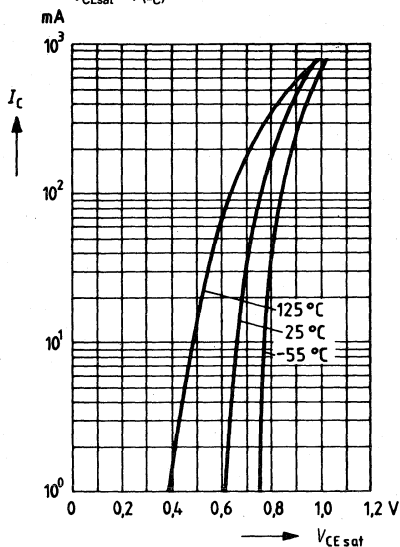

Base-emitter saturation voltage

$V_{BEsat} = f(I_C)$

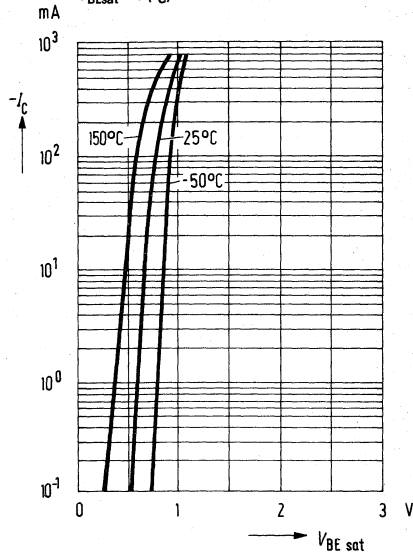

DC current gain $h_{FE} = f(I_C)$

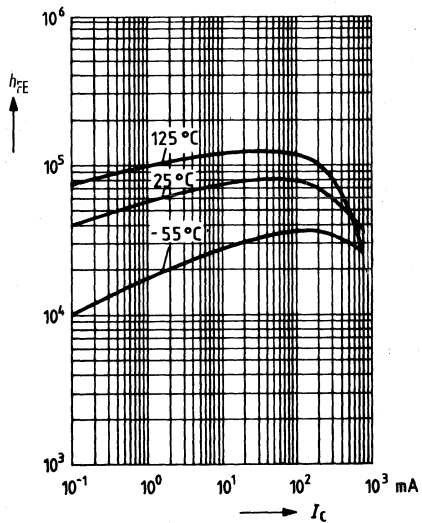

Collector-base capacitance $C_{CBO} = f(V_{CBO})$
Emitter-base capacitance $C_{EBO} = f(V_{EBO})$

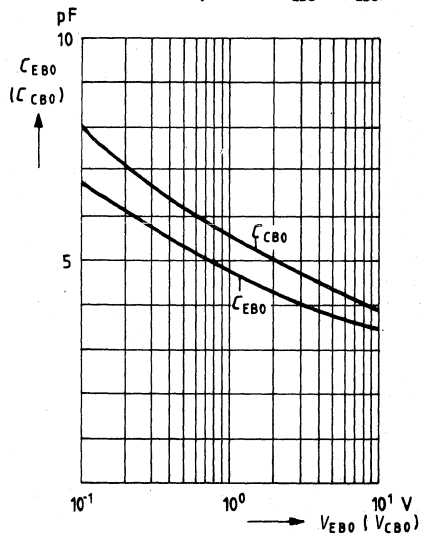

NPN Silicon Planar Transistors

BCW 60
BCW 60 F **BCX 70**
BCW 60 R **BCX 70 R**

BCW 60 and BCX 70 are epitaxial NPN silicon planar transistors in TO 236 plastic package (23 A 3 DIN 41869). They are intended for AF input stages and switching applications, in particular for use in thick and thin film circuits. Both types – BCW 60 and BCX 70 – are marked by the letter >A<, the adjacent letter (A, B, C, or D for type BCW 60 and G, H, J, or K for type BCX 70) indicates the relevant current amplification of the transistor. Complementary transistors are the types BCW 61 and BCX 71. If desired the BCW 60 is also available as particularly low-noise version ($NF < 2$ dB) under the designation BCW 60 F and marked with >AF< or >AN<. The transistors BCW 60 and BCX 70 are also available, if required, with changed terminal sequence (>E< and >B< interchanged) under the designation BCW 60 R (marked >AO< to >AS<) as well as BCX 70 R (marked >AU< to >AY<).

Type	Mark	Ordering code	Type	Mark	Ordering code
BCW60 ²⁾		Q62702-C709	BCW60FF	AF	Q62702-C1052
BCW60A	AA	Q62702-C331	BCW60FN	AN	Q62702-C1053
BCW60B	AB	Q62702-C332	BCX70 ²⁾		Q62702-C434
BCW60C	AC	Q62702-C333	BCX70G	AG	Q62702-C423
BCW60D	AD	Q62702-C334	BCX70H	AH	Q62702-C424
BCW60RA	AO	Q62702-C1054	BCX70J	AJ	Q62702-C425
BCW60RB	AP	Q62702-C1055	BCX70K	AK	Q62702-C426
BCW60RC	AR	Q62702-C1056	BCX70RG	AU	Q62702-C901
BCW60RD	AS	Q62702-C1057	BCX70RH	AW	Q62702-C900
			BCX70RJ	AX	Q62702-C899
			BCX70RK	AY	Q62702-C888

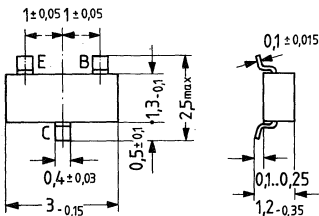

Approx. weight 0.02 g

Dimensions in mm

Maximum ratings

	BCW 60	BCX 70	
Collector-emitter voltage	V_{CES} 32	45	V
Collector-emitter voltage	V_{CEO} 32	45	V
Emitter-base voltage	V_{EBO} 5	5	V
Collector current	I_C 200	200	mA
Base current	I_B 50	50	mA
Junction temperature	T_j 150	150	°C
Storage temperature range	T_{stg} -55 to +125	-55 to +125	°C
Total power dissipation ($T_{SB} = 50^\circ\text{C}$)	P_{tot} 310	310	mW

Thermal resistance

Junction to ambient air	R_{thJA}	≤ 450	≤ 450	K/W
Junction to substrate back ¹⁾	R_{thJSB}	≤ 320	≤ 320	K/W

1) Ceramic substrate 0.7 mm; 2.5 cm² area

2) If the order does not include any exact indication of the current amplification group desired, a transistor of a current amplification group just available from stock will be delivered.

BCW 60
BCW 60 F BCX 70
BCW 60 R BCX 70 R

Static characteristics ($T_{amb} = 25^{\circ}\text{C}$)

The transistors BCW 60 and BCX 70 are grouped in accordance with the DC current gain h_{FE} and marked by letters.

h_{FE} group for BCW 60	A	B	C	D	BCW 60	
for BCX 70	G	H	J	K	BCX 70	
V_{CE} V	I_C mA	h_{FE} I_C/I_B	h_{FE} I_C/I_B	h_{FE} I_C/I_B	h_{FE} I_C/I_B	V_{BE} V
5	0.01	78	145 (>20)	220 (>40)	300 (>100)	0.52
5	2	170 (120 to 220)*	250 (180 to 310)*	350 (250 to 460)*	500 (380 to 630)*	0.65 (0.55 to 0.75)*
1	50	>50	>70	>90	>100	0.78

Saturation voltages

$I_C = 10 \text{ mA}; I_B = 0.25 \text{ mA}$
 $I_C = 50 \text{ mA}; I_B = 1.25 \text{ mA}$

V_{CEsat} (V)	V_{BEsat} (V)
0.12 (≤ 0.35)	0.7 (≤ 0.85)
0.2 (≤ 0.55)	0.83 (≤ 1.05)

Collector cutoff current

($V_{CES} = 32 \text{ V}$)

($V_{CES} = 45 \text{ V}$)

Collector cutoff current

($V_{CES} = 32 \text{ V}; T_{amb} = 150^{\circ}\text{C}$)

($V_{CES} = 45 \text{ V}; T_{amb} = 150^{\circ}\text{C}$)

Emitter cutoff current

($V_{EBO} = 4 \text{ V}$)

Collector-emitter breakdown voltage

($I_{CEO} = 2 \text{ mA}$)

Emitter-base breakdown voltage

($I_{EBO} = 1 \mu\text{A}$)

	BCW 60	BCX 70	
I_{CES}	<20	-	nA*
I_{CES}	-	<20	nA*
I_{CES}	<20	-	μA
I_{CES}	-	<20	μA
I_{EBO}	<20	<20	nA*
$V_{(BR)CEO}$	>32	>45	V*
$V_{(BR)EBO}$	>5	>5	V*

*) AQL = 0.65%

BCW 60
BCW 60 F BCX 70
BCW 60 R BCX 70 R

Dynamic characteristics ($T_{amb} = 25^{\circ}\text{C}$)

Transition frequency ($I_C = 10\text{ mA}$;
 $V_{CE} = 5\text{ V}$; $f = 100\text{ MHz}$)
Collector-base capacitance
($V_{CBO} = 10\text{ V}$; $f = \text{MHz}$)
Emitter-base capacitance
($V_{EBO} = 0.5\text{ V}$; $f = 1\text{ MHz}$)
Noise figure ($I_C = 0.2\text{ mA}$;
 $V_{CE} = 5\text{ V}$; $R_g = 2\text{ k}\Omega$;
 $f = 1\text{ kHz}$; $\Delta f = 200\text{ Hz}$)

	BCW 60	BCX 70	
f_T	250 (>125)	250 (>125)	MH
C_{CBO}	<4.5	<4.5	pF
C_{EBO}	8	8	pF
NF	2 (<6)	2 (<6)	dB

Four-pole characteristics: ($I_C = 2\text{ mA}$; $V_{CE} = 5\text{ V}$; $f = 1\text{ kHz}$)

h_{FE} group	A; G	B; H	C; J	D; K	
h_{11e}	2.7 (1.6 to 4.5)	3.6 (2.5 to 6)	4.5 (3.2 to 8.5)	7.5 (4.5 to 12)	k Ω
h_{12e}	1.5	2	2	3	10^{-4}
h_{21e}	200	260	330	520	-
h_{22e}	18 (<30)	24 (<50)	30 (<60)	50 (<100)	μS

Switching times:

Operating point

$I_C : I_{B1} : -I_{B2}$ approx. 10:1:1 mA : $R_1 = 5\text{ k}\Omega$; R_2 approx. 5 k Ω ; $-V_{BB} = 3.6\text{ V}$; $R_L = 990\ \Omega$

t_d	35	ns	t_s	400	ns
t_r	50	ns	t_t	80	ns
t_{on}	85 (<150)	ns	t_{off}	480 (<800)	ns

Test circuit for switching times:

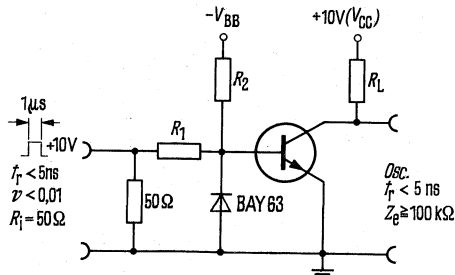

BCW 60
BCW 60 F BCX 70
BCW 60 R BCX 70 R

**Total perm. power dissipation
 versus temperature**
 $P_{tot} = f(T)$

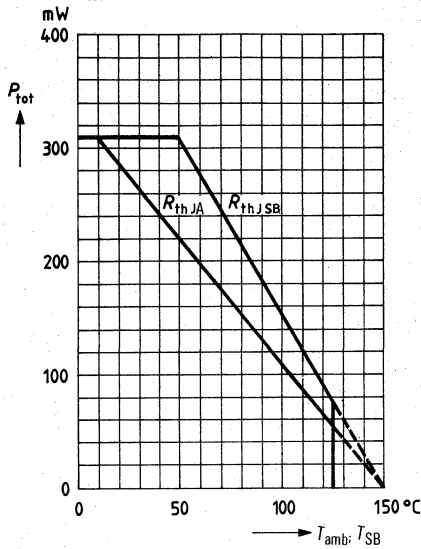

Pulse resistance $\frac{r_{thJSB}}{R_{thJSB}} = f(t)$
 D = parameter

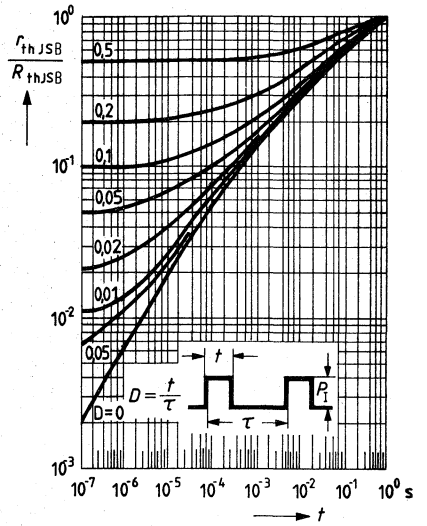

BCW 60
BCW 60 F BCX 70
BCW 60 R BCX 70 R

DC current gain $h_{FE} = f(I_C)$
 $V_{CE} = 1 \text{ V}; T_{amb} = \text{parameter}$

BCW 60 B
BCX 70 H

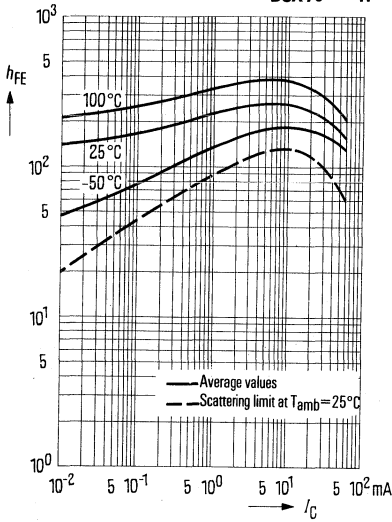

Output characteristics $I_C = f(V_{CE})$
 $I_B = \text{parameter}$
 (common emitter configuration)

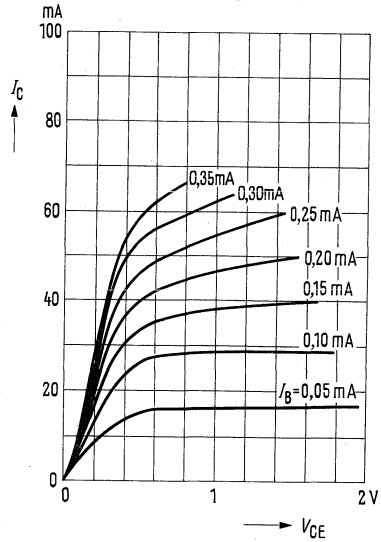

Input characteristic $I_B = f(V_{BE})$
 $V_{CE} = 5 \text{ V}$
 (common emitter configuration)

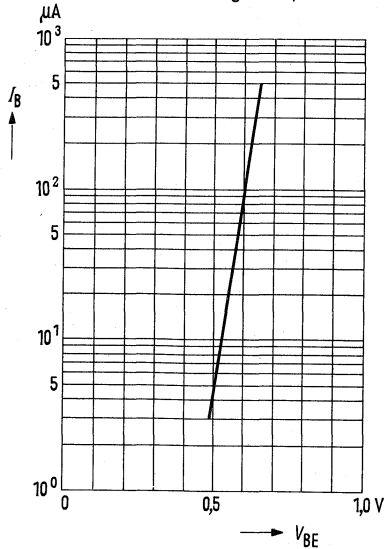

Collector cutoff current versus temperature $I_{CES} = f(T_{amb})$ for max. permissible reverse voltage

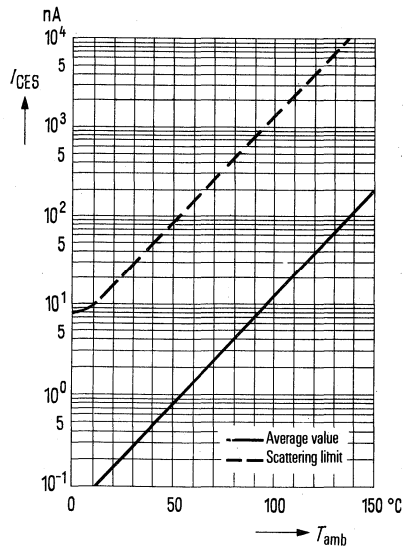

BCW 60
BCW 60 F BCX 70
BCW 60 R BCX 70 R

Collector emitter saturation voltage

$V_{CEsat} = f(I_C); h_{FE} = 40$

$T_{amb} = \text{parameter}$

(common emitter configuration)

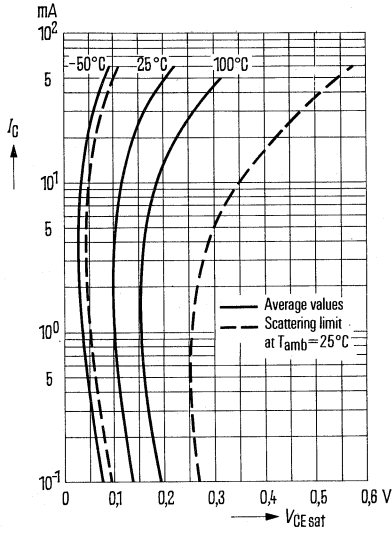

Base-emitter saturation voltage

$V_{BEsat} = f(I_C); T_{amb} = \text{parameter};$

$h_{FE} = 40$

(common emitter configuration)

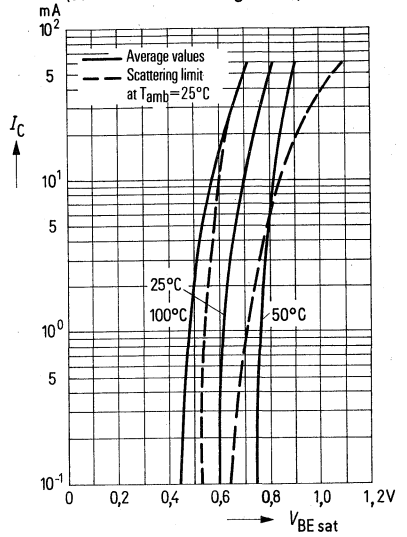

Collector current $I_C = f(V_{BE})$

$V_{CE} = 1\text{V}$ (base-emitter configuration)

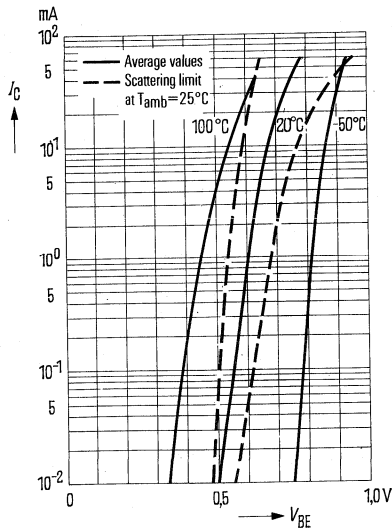

Transition frequency $f_T = f(I_C)$

$V_{CE} = \text{parameter}$

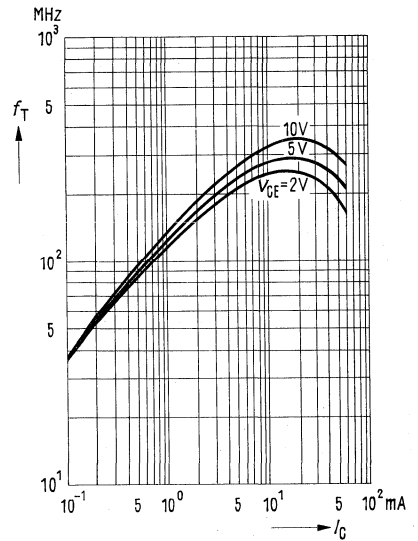

**BCW 60
BCW 60 F BCX 70
BCW 60 R BCX 70 R**

***h*-parameter versus collector current**

$$H_e = \frac{h_e(I_c)}{h_e(I_c = 2 \text{ mA})} = f(I_c)$$

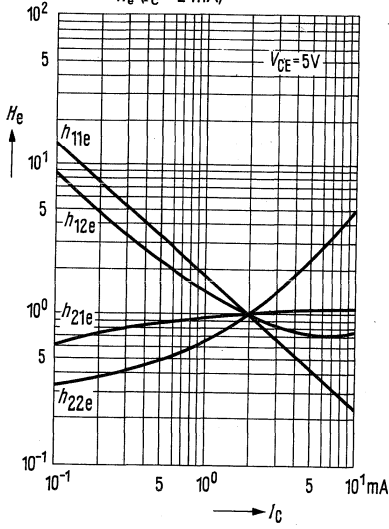

***h*-parameter versus collector-emitter voltage**

$$H_e = \frac{h_e(V_{CE})}{h_e(V_{CE} = 5 \text{ V})} = f(V_{CE})$$

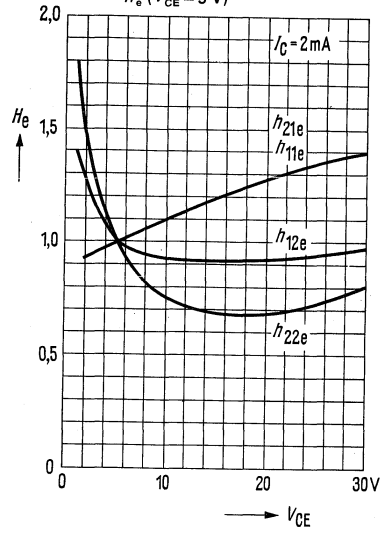

**Collector-base capacitance $C_{CBO} = f(V_{CBO})$
Emitter-base capacitance $C_{EBO} = f(V_{EBO})$**

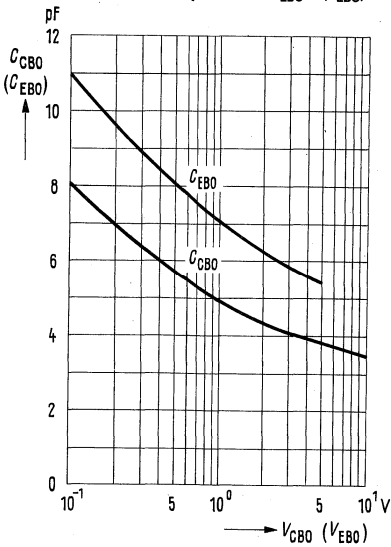

BCW 61 and BCX 71 are epitaxial PNP silicon planar transistors in TO 236 plastic package (23 A 3 DIN 41869). They are intended for AF input stages and switching applications, in particular for use in thick and thin film circuits. Both types – BCW 61 and BCX 71 – are marked by the letter »B«, the adjacent letter (A, B, C, or D for the type BCW 61 and G, H, J, or K for type BCX 71) indicates the relevant current amplification of the transistors. Complementary transistors are the types BCW 60 and BCX 70. If desired the BCW 61 is also available as particularly low-noise version (NF < 2 dB) under the designation BCW 61 F and marked with »BF« or »BN«. The transistors BCW 61 and BCX 71 are also available – if required – with changed terminal sequence (»E« and »B« interchanged) under the designation BCW 61 R (marked »BO« to »BS«) as well as BCX 71 R (marked »BU« to »BY«).

Type	Mark	Ordering code	Type	Mark	Ordering code
BCW61 ²⁾		Q62702-C710	BCW61 RA	BO	Q62702-C897
BCW 16 A	BA	Q62702-C335	BCW61 RB	BP	Q62702-C896
BCW61 B	BB	Q62702-C336	BCW61 RC	BR	Q62702-C895
BCW61 C	BC	Q62702-C337	BCW61 RD	BS	Q62702-C890
BCW61 D	BD	Q62702-C338	BCW61 FF	BF	Q62702-C1058
			BCW61 FN	BN	Q62702-C1059
			BCX71 ²⁾		Q62702-C435
			BCX71 G	BG	Q62702-C427
			BCX71 H	BH	Q62702-C428
			BCX71 J	BJ	Q62702-C429
			BCX71 K	BK	Q62702-C430
			BCX71 RG	BU	Q62702-C906
			BCX71 RH	BW	Q62702-C893
			BCX71 RJ	BX	Q62702-C892
			BCX71 RK	BY	Q62702-C889

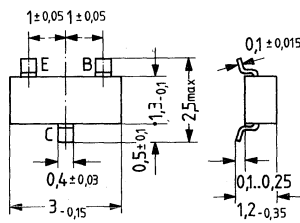

Approx. weight 0.02 g
 Dimensions in mm

Maximum ratings

	BCW 61	BCX 71	
Collector-emitter voltage	-V _{CES} 32	45	V
Collector-emitter voltage	-V _{CEO} 32	45	V
Emitter-base voltage	-V _{EBO} 5	5	V
Collector current	-I _C 200	200	mA
Base current	-I _B 50	50	mA
Junction temperature	T _j 150	150	°C
Storage temperature range	T _{stg} -55 to +125	-55 to +125	°C
Total power dissipation (T _{SB} = 50°C)	P _{tot} 310	310	mW

Thermal resistance

Junction to ambient air	R _{thJA}	≤ 450	≤ 450	K/W
Junction to substrate back ¹⁾	R _{thJSB}	≤ 320	≤ 320	K/W

1) Ceramic substrate 0.7 mm; 2.5 cm² area
 2) If the order does not include any exact indication of the current amplification group desired, a transistor of a current amplification group just available from stock will be delivered.

BCW 61
BCW 61 F BCX 71
BCW 61 R BCX 71 R

Static characteristics ($T_{amb} = 25^{\circ}\text{C}$)

The transistors are grouped in accordance with the DC current gain h_{FE} and marked by letters.

h_{FE} group for BCW 61	A	B	C	D	BCW 61
for BCX 71	G	H	J	K	BCX 71
$-V_{CE} - I_C$ V mA	h_{FE} I_C/I_B	h_{FE} I_C/I_B	h_{FE} I_C/I_B	h_{FE} I_C/I_B	$-V_{BE}$ V
5 0.01	140	200 (>30)	270 (>40)	340 (>100)	0.55
5 2	170 (120 to 220)*	250 (140 to 310)*	350 (250 to 460)*	500 (380 to 630)*	0.65 (0.6 to 0.75)*
1 50	>60	>80	>100	>110	0.72

Saturation voltages

$-I_C = 10 \text{ mA}; -I_B = 0.25 \text{ mA}$
 $-I_C = 50 \text{ mA}; -I_B = 1.25 \text{ mA}$

$-V_{CEsat}(V)$	$-V_{BEsat}(V)$
0.12 (≤ 0.25)	0.7 (≤ 0.85)
0.25 (≤ 0.55)	0.8 (≤ 1.05)

Collector cutoff current

$(-V_{CES} = 32 \text{ V})$

$(-V_{CES} = 45 \text{ V})$

Collector cutoff current

$(-V_{CES} = 32 \text{ V}; T_{amb} = 150^{\circ}\text{C})$

$(-V_{CES} = 45 \text{ V}; T_{amb} = 150^{\circ}\text{C})$

Emitter cutoff current

Collector-emitter breakdown voltage

$(-I_{CEO} = 2 \text{ mA})$

Emitter-base breakdown voltage

$(-I_{EBO} = 1 \text{ }\mu\text{A})$

	BCW 61	BCX 71	
$-I_{CES}$	<20	-	nA*
$-I_{CES}$	-	<20	nA*
$-I_{CES}$	<20	-	μA
$-I_{CES}$	-	<20	μA
$-I_{EBO}$	<20	<20	nA*
$-V_{(BR)CEO}$	>32	>45	V*
$-V_{(BR)EBO}$	>5	>5	V*

* AQL = 0.65%

BCW 61
BCW 61 F BCX 71
BCW 61 R BCX 71 R

Dynamic characteristics ($T_{amb} = 25^\circ\text{C}$)

Transition frequency ($I_C = 10\text{ mA}$;
 $-V_{CE} = 5\text{ V}$; $f = 100\text{ MHz}$)
Collector-base capacitance
($-V_{CBO} = 10\text{ V}$; $f = 1\text{ MHz}$)
Emitter-base capacitance
($-V_{EBO} = 0.5\text{ V}$; $f = 1\text{ MHz}$)
Noise figure ($-I_C = 0.2\text{ mA}$;
 $-V_{CE} = 5\text{ V}$; $R_g = 2\text{ k}\Omega$;
 $f = 1\text{ kHz}$; $\Delta f = 200\text{ Hz}$)

	BCW 61	BCX 71	
f	180	180	MHz
C_{CBO}	<6	<6	pF
C_{EBO}	11	11	pF
NF	2 (<6)	2 (<6)	dB

Four-pole characteristics ($I_C = 2\text{ mA}$; $V_{CE} = 5\text{ V}$; $f = 1\text{ kHz}$)

h_{FE} group	A; G	B; H	C; J	D; K	
h_{11e}	2.7 (1.6 to 4.5)	3.6 (2.5 to 6)	4.5 (3.2 to 8.5)	7.5 (4.5 to 12)	$\text{k}\Omega$
h_{12e}	1.5	2	2	3	10^{-4}
h_{21e}	200	260	330	520	-
h_{22e}	18 (<30)	24 (<50)	30 (<60)	50 (<100)	μS

Switching times:

Operating point:

$-I_C : -I_{B1} : I_{B2}$ approx. 10:1:1 mA; $R_1 = 5\text{ k}\Omega$; $R_2 = 5\text{ k}\Omega$; $V_{BB} = 3.6$; $R_L = 990\ \Omega$

t_d	35	ns	t_s	400	ns
t_r	50	ns	t_t	80	ns
t_{on}	85 (<150)	ns	t_{off}	480 (<800)	ns

Test circuit for switching times:

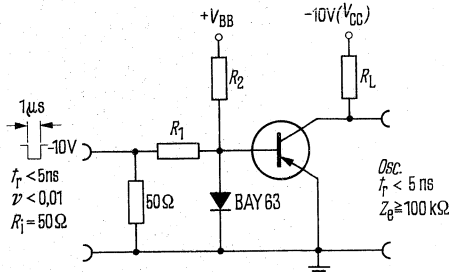

BCW 61
BCW 61 F BCX 71
BCW 61 R BCX 71 R

Total perm. power dissipation versus temperature

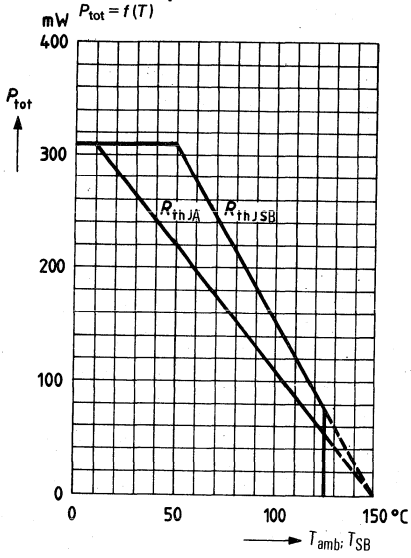

Pulse resistance $\frac{r_{\text{thJSB}}}{R_{\text{thJSB}}} = f(t)$
D = parameter

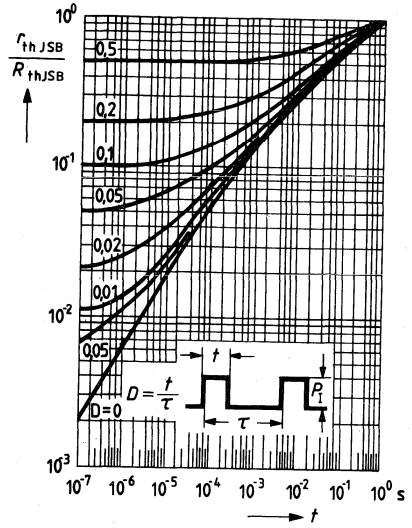

BCW 61
BCW 61 F BCX 71
BCW 61 R BCX 71 R

DC current gain $h_{FE} = f(I_C)$
 $V_{CE} = 1V; T_{amb} = \text{parameter}$

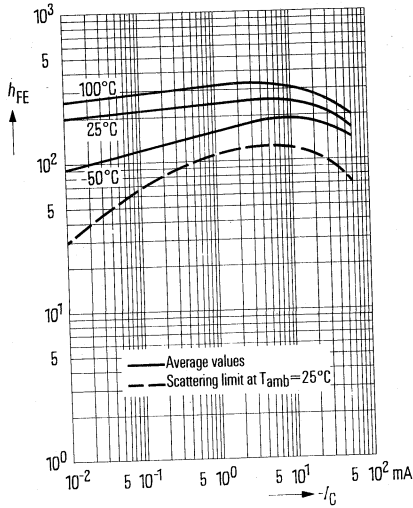

Output characteristics $I_C = f(V_{CE})$
 $I_B = \text{parameter}$

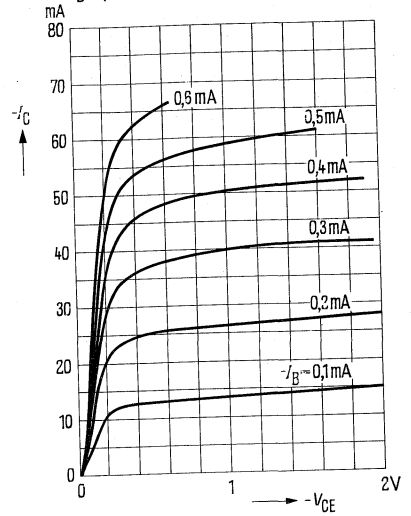

Input characteristic $I_C = f(V_{BE})$
 $V_{CE} = 5V; T_{amb} = 25^\circ\text{C}$

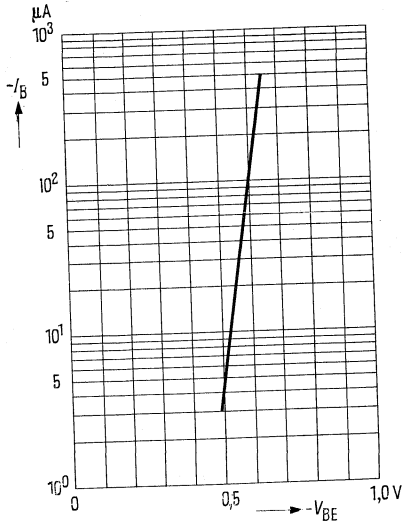

Collector cutoff current versus temperature $I_{CES} = f(T_{amb})$ for max. permissible reverse voltage

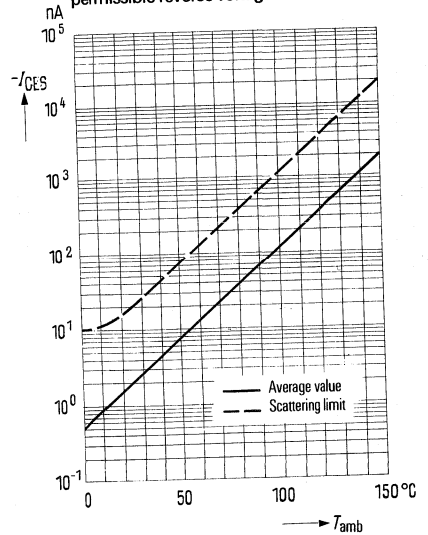

BCW 61
BCW 61 F BCX 71
BCW 61 R BCX 71 R

Collector-emitter saturation voltage

$V_{CEsat} = f(I_C); h_{FE} = 40$
 $T_{amb} = \text{parameter}$

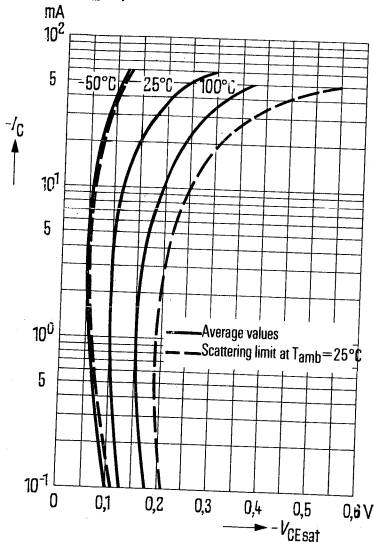

Base-emitter saturation voltage

$V_{BEsat} = f(I_C); T_{amb} = \text{parameter};$
 $h_{FE} = 40$

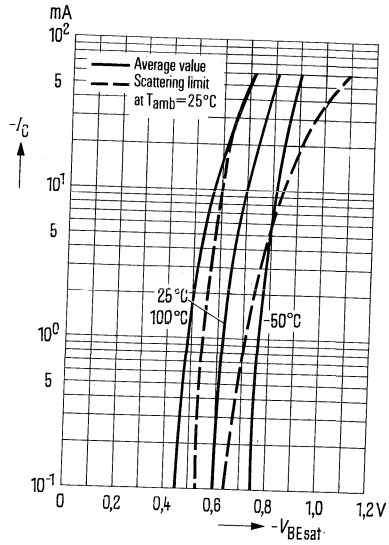

Collector current $I_C = f(V_{BE})$

$V_{CE} = 1 \text{ V}; T_{amb} = \text{parameter}$

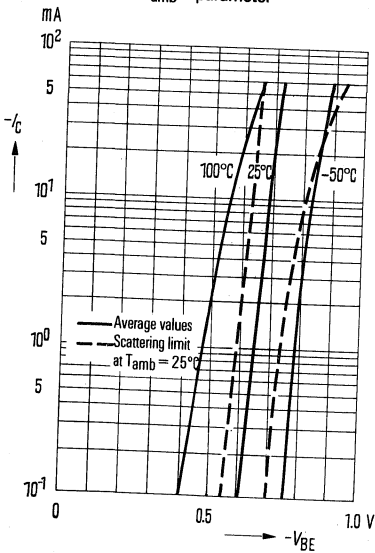

Transition frequency $f_T = f(I_C)$

$T_{amb} = 25^\circ\text{C}$

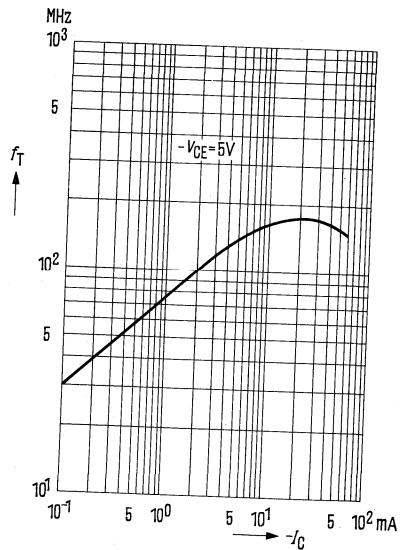

BCW 61
BCW 61 F BCX 71
BCW 61 R BCX 71 R

***h*-parameter versus collector current**

$$H_o = \frac{h_o(I_c)}{h_o(I_c = 2 \text{ mA})} = f(I_c)$$

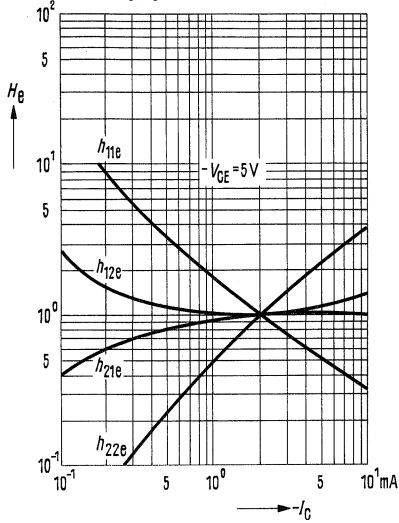

***h*-parameter versus collector-emitter voltage**

$$H_o = \frac{h_o(V_{CE})}{h_o(V_{CE} = 5 \text{ V})} = f(V_{CE})$$

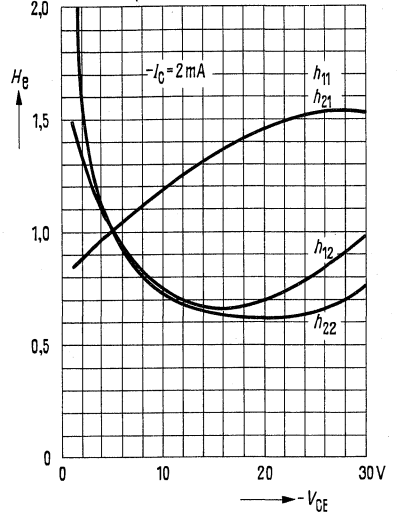

Collector-base capacitance $C_{CBO} = f(V_{CBO})$

Emitter-base capacitance $C_{EBO} = f(V_{EBO})$

$f = 1 \text{ MHz}; T_{\text{amb}} = 25^\circ \text{C}$

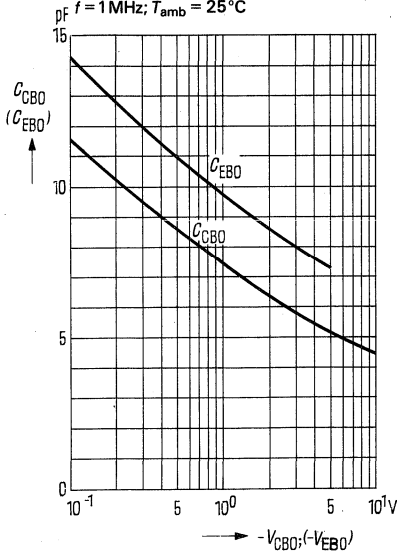

BCW 65 and BCW 66 are epitaxial NPN silicon planar transistors in TO 236 plastic encapsulation (23 A 3 DIN 41 869). They are intended for AF driver and switching applications, as well as for general purpose applications, in particular for use in thick and thin film circuits. Both types – BCW 65 and BCW 66 – are marked by the letter »E«, the adjacent letter (A, B, or C for type BCW 65 and F, G, H, for type BCW 66) indicates the relevant current amplification of the transistor. Complementary transistors are the types BCW 67 and BCW 68. The transistors BCW 65 and BCW 66 are also available – if required – with changed terminal sequence (»E« and »B« interchanged) under the designation BCW 65 R (marked »ET«, »EU« and »EW«) as well as BCW 66 R (marked »EX«, »EY«, and »EZ«).

Type	Mark	Ordering code	Type	Mark	Ordering code
BCW 65 ²⁾		Q62702-C711	BCW 66 RF	EX	Q62702-C928
BCW 65 A	EA	Q62702-C457	BCW 66 RG	EY	Q62702-C929
BCW 65 B	EB	Q62702-C458	BCW 66 RH	EZ	Q62702-C918
BCW 65 C	EC	Q62702-C459			
BCW 65 RA	ET	Q62702-C925			
BCW 65 RB	EU	Q62702-C926			
BCW 65 RC	EW	Q62702-C927			
BCW 66 ²⁾		Q62702-C712			
BCW 66 F	EF	Q62702-C460			
BCW 66 G	EG	Q62702-C461			
BCW 66 H	EH	Q62702-C462			

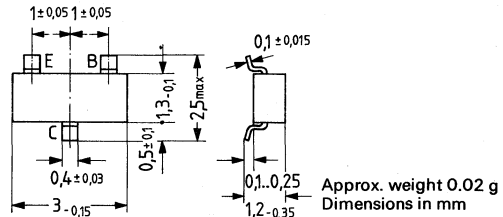

Maximum ratings

		BCW 65	BCW 66	
Collector-emitter voltage	V_{CES}	60	75	V
Collector-emitter voltage	V_{CEO}	32	45	V
Emitter-base voltage	V_{EBO}	5	5	V
Collector current	I_C	800	800	mA
Collector peak current ($t < 10$ ms)	I_{CM}	1	1	A
Base current	I_B	100	100	mA
Junction temperature	T_j	150	150	°C
Storage temperature range	T_{stg}	-55 to +150	-55 to +150	°C
Total power dissipation ($T_{SB} = 50^\circ\text{C}$)	P_{tot}	360	360	mW

Thermal resistance

Junction to ambient air	R_{thJA}	≤ 375	≤ 375	K/W
Junction to substrate back ¹⁾	R_{thJSB}	≤ 278	≤ 278	K/W

1) Ceramic substrate 0.7 mm; 2.5 cm² area

2) If the order does not include any exact indication of the current amplification group desired, a transistor of a current amplification group just available from stock will be delivered.

Static characteristics ($T_{amb} = 25^{\circ}\text{C}$)

The transistors BCW 65 and BCW 66 are grouped in accordance with the DC current gain h_{FE} and marked by letters.

h_{FE} group for BCW 65		A	B	C
for BCW 66		F	G	H
V_{CE} V	I_C mA	h_{FE} I_C/I_B	h_{FE} I_C/I_B	h_{FE} I_C/I_B
10	0.1	> 35	> 50	> 80
1	10	> 75	> 110	> 180
1	100	> 160 (100 to 250)*	250 (160 to 400)*	350 (250 to 630)*
2	500	> 35	> 60	> 100

Saturation voltages

$I_C = 100 \text{ mA}; I_B = 10 \text{ mA}$
 $I_C = 500 \text{ mA}; I_B = 50 \text{ mA}$

V_{CESat} (V)	V_{BEsat} (V)
≤ 0.3	≤ 1.25
≤ 0.7	≤ 2

Collector cutoff current

($V_{CES} = 32 \text{ V}$)

($V_{CES} = 45 \text{ V}$)

Collector cutoff current

($V_{CES} = 32 \text{ V}; T_{amb} = 150^{\circ}\text{C}$)

($V_{CES} = 45 \text{ V}; T_{amb} = 150^{\circ}\text{C}$)

Emitter cutoff current

($V_{EBO} = 4 \text{ V}$)

Collector-emitter breakdown voltage

($I_{CEO} = 10 \text{ mA}$)

Emitter-base breakdown voltage

($I_{EBO} = 10 \text{ }\mu\text{A}$)

Collector-emitter breakdown voltage

($I_C = 10 \text{ }\mu\text{A}$)

	BCW 65	BCW 66	
I_{CES}	< 20	–	nA*
I_{CES}	–	< 20	nA*
I_{CES}	< 20	–	μA
I_{CES}	–	< 20	μA
I_{EBO}	< 20	< 20	nA*
$V_{(BR)CEO}$	> 32	> 45	V*
$V_{(BR)EBO}$	> 6	> 5	V*
$V_{(BR)CES}$	> 60	> 75	V

*AQL = 0.65%

Dynamic characteristics ($T_{amb} = 25^{\circ}\text{C}$)

Transition frequency ($I_C = 20\text{ mA}$;
 $V_{CE} = 10\text{ V}$; $f = 100\text{ MHz}$)
 Collector-base capacitance
 ($V_{CBO} = 10\text{ V}$; $f = 1\text{ MHz}$)
 Emitter-base capacitance
 ($V_{EBO} = 0.5\text{ V}$; $f = 1\text{ MHz}$)
 Noise figure ($I_C = 0.2\text{ mA}$; $V_{CE} = 5\text{ V}$;
 R_g ; $1\text{ k}\Omega$; $f = 1\text{ kHz}$)

Switching times:

($I_C = 150\text{ mA}$; $I_{B1} = -I_{B2} = 15\text{ mA}$;
 $R_L = 150\ \Omega$)

	BCW 65	BCW 66	
f_T	> 100	> 100	MHz
C_{CBO}	8 (< 12)	8 (< 12)	pF
C_{EBO}	< 80	< 80	pF
NF	2 (< 10)	2 (< 10)	dB
t_{on}	< 100	< 100	ns
t_{off}	< 400	< 400	ns

Total perm. power dissipation versus temperature

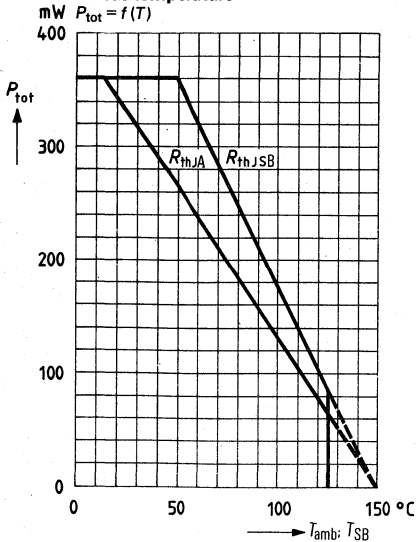

Pulse resistance $\frac{r_{thJSB}}{R_{thJSB}} = f(t)$
 $D = \text{parameter}$

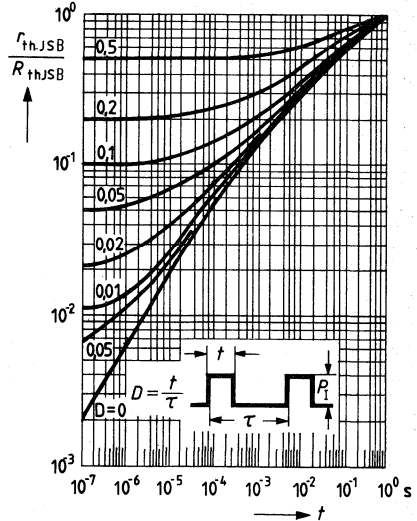

DC current gain $h_{FE} = f(I_C)$
 $V_{CE} = 1V; T_{amb} = \text{parameter}$

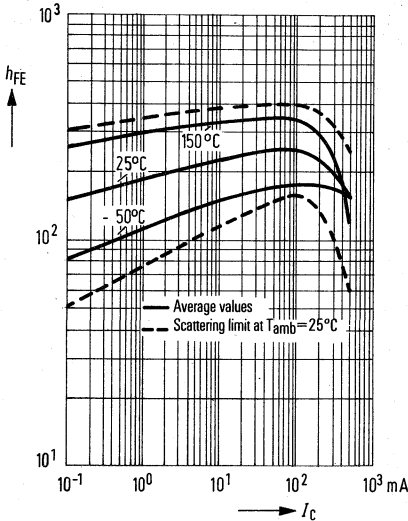

Output characteristics $I_C = f(V_{CE})$
 $V_{BE} = \text{parameter}$
 (common emitter configuration)

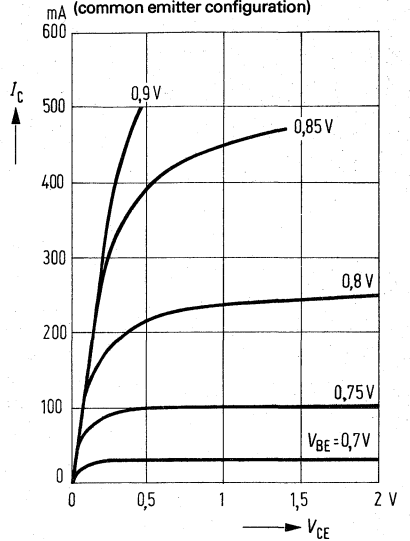

Collector cutoff current versus temperature $I_{CES} = f(T_{amb})$ for max. permissible reverse voltage

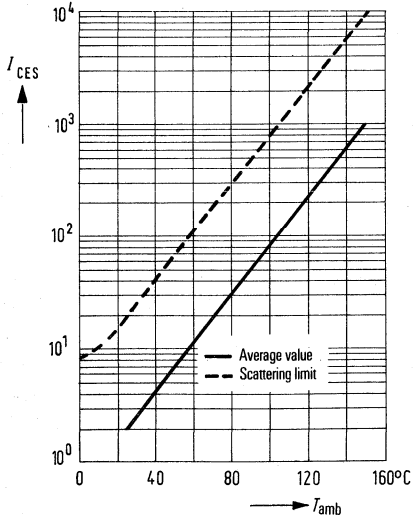

Collector current $I_C = f(V_{BE})$
 $V_{CE} = 1V; T_{amb} = \text{parameter}$

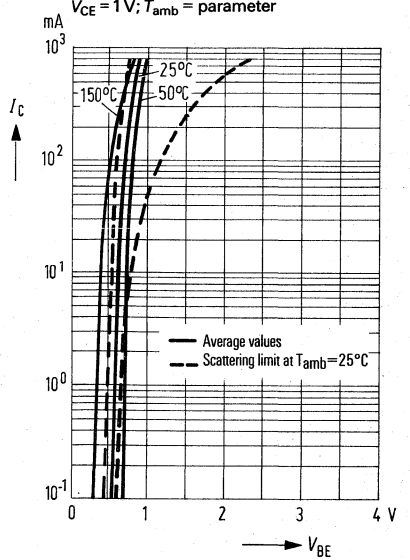

Collector-emitter saturation voltage

$V_{CEsat} = f(I_C); h_{FE} = 10;$
 $T_{amb} = \text{parameter}$

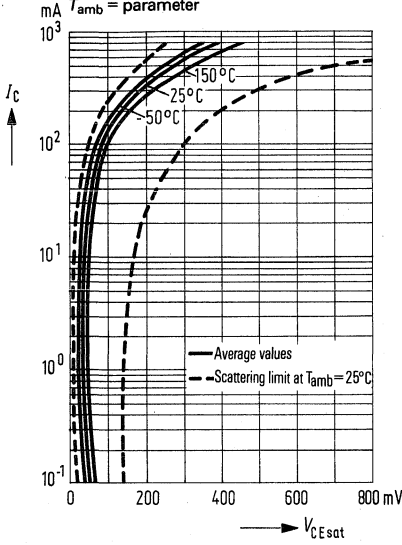

Base-emitter saturation voltage

$V_{BEsat} = f(I_C); h_{FE} = 10;$
 $T_{amb} = \text{parameter}$

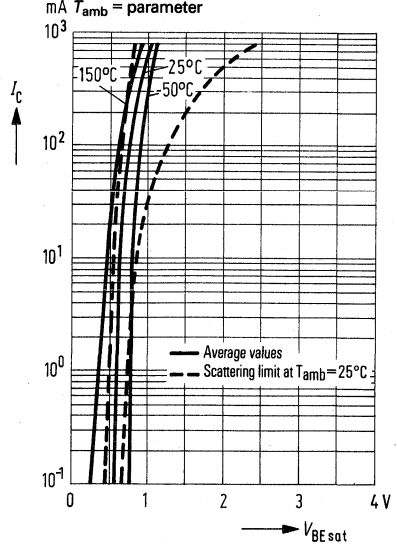

Transition frequency $f_T = f(I_C)$:

$V_{CE} = \text{parameter}$

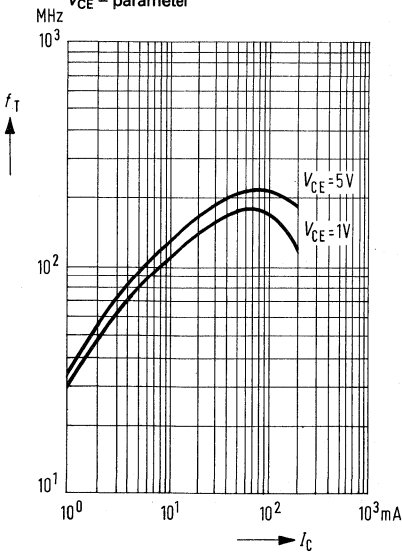

BCW 67 and BCW 68 are epitaxial PNP silicon planar transistors in TO 236 plastic encapsulation (23 A 3 DIN 41 869). They are intended for AF driver and switching applications, as well as for general purpose applications, in particular for use in thick and thin film circuits. Both types – BCW 67 and BCW 68 – are marked by the letter »D«, the adjacent letter (A, B, or C for type BCW 67 and F, G, H, for type BCW 68) indicates the relevant current amplification of the transistor. Complementary transistors are the types BCW 65 and BCW 66. The transistors BCW 67 and BCW 68 are also available – if required – with changed terminal sequence (»E« and »B« interchanged) under the designation BCW 67 R (marked »DT«, »DU« and »DW«) as well as BCW 68 R (marked »DX«, »DY«, and »DZ«).

Type	Mark	Ordering code
BCW 67 ²⁾		Q62702-C713
BCW 67 A	DA	Q62702-C463
BCW 67 B	DB	Q62702-C464
BCW 67 C	DC	Q62702-C465
BCW 67 RA	DT	Q62702-C921
BCW 67 RB	DU	Q62702-C919
BCW 67 RC	DW	Q62702-C1060
BCW 68 ²⁾		Q62702-C714
BCW 68 F	DF	Q62702-C466
BCW 68 G	DG	Q62702-C467
BCW 68 H	DH	Q62702-C468

Type	Mark	Ordering code
BCW 68 RF	DX	Q62702-C922
BCW 68 RG	DY	Q62702-C923
BCW 68 RH	DZ	Q62702-C924

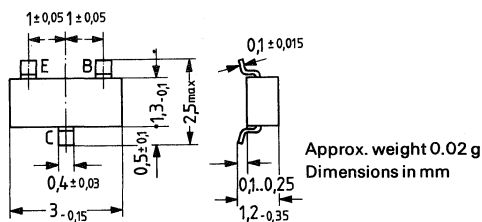

Maximum ratings

	BCW 67	BCW 68		
Collector-emitter voltage	-V _{CES}	45	60	V
Collector-emitter voltage	-V _{CEO}	32	45	V
Emitter-base voltage	-V _{EBO}	5	5	V
Collector current	-I _C	800	800	mA
Collector peak current	-I _{CM}	1000	1000	mA
Base current	-I _B	100	100	mA
Junction temperature	T _j	150	150	°C
Storage temperature range	T _{stg}	-55 to +150	-55 to +150	°C
Total power dissipation (T _{SB} = 50°C)	P _{tot}	360	360	mW

Thermal resistance

Junction to ambient air	R _{thJA}	≤ 375	≤ 375	K/W
Junction to substrate back ¹⁾	R _{thJSB}	≤ 278	≤ 278	K/W

1) Ceramic substrate 0.7 mm; 2.5 cm² area

2) If the order does not include any exact indication of the current amplification group desired, a transistor of a current amplification group just available from stock will be delivered.

Static characteristics ($T_{amb} = 25^{\circ}\text{C}$)

The transistors BCW 67 and BCW 68 are grouped in accordance with the DC current gain h_{FE} and marked by letters.

h_{FE} group for BCW 67	A	B	C
for BCW 68	F	G	H
$-V_{CE}$ V	$-I_C$ mA	h_{FE} I_C/I_B	h_{FE} I_C/I_B
1	10	>75	>120
1	100	170 (100 to 250)*	260 (160 to 400)*
2	500	>35	>60
			>100

Saturation voltages

$-I_C = 100 \text{ mA}; -I_B = 10 \text{ mA}$
 $-I_C = 500 \text{ mA}; -I_B = 50 \text{ mA}$

$-V_{CEsat}$ (V)	$-V_{BEsat}$ (V)
≤ 0.3	≤ 1.25
≤ 0.7	≤ 2

Collector cutoff current

($-V_{CES} = 32 \text{ V}$)

($-V_{CES} = 45 \text{ V}$)

Collector cutoff current

($-V_{CES} = 32 \text{ V}; T_{amb} = 150^{\circ}\text{C}$)

($-V_{CES} = 45 \text{ V}; T_{amb} = 150^{\circ}\text{C}$)

Emitter cutoff current

($-V_{EBO} = 4 \text{ V}$)

Collector-emitter breakdown voltage

($-I_{CEO} = 10 \text{ mA}$)

Emitter-base breakdown voltage

($-I_{EBO} = 1 \mu\text{A}$)

	BCW 67	BCW 68	
$-I_{CES}$	<20	-	nA*
$-I_{CES}$	-	<20	nA*
$-I_{CES}$	<10	-	μA
$-I_{CES}$	-	<10	μA
$-I_{EBO}$	<20	<20	nA*
$-V_{(BR)CEO}$	>32	>45	V*
$-V_{(BR)EBO}$	>5	>5	V*

*AQL = 0.65%

Dynamic characteristics ($T_{amb} = 25^{\circ}\text{C}$)

Transition frequency ($I_C = 80 \text{ mA}$;
 $-V_{CE} = 10 \text{ V}$; $f = 100 \text{ MHz}$)
 Collector-base capacitance
 ($-V_{CBO} = 10 \text{ V}$; $f = 1 \text{ MHz}$)
 Emitter-base capacitance
 ($-V_{EBO} = 0.5 \text{ V}$; $f = 1 \text{ MHz}$)
 Noise figure ($-I_C = 0.2 \text{ mA}$; $V_{CE} = 5 \text{ V}$;
 $T_g = 1 \text{ k}\Omega$; $f = 1 \text{ kHz}$; $\Delta f = 200 \text{ Hz}$)

	BCW 67	BCW 68	
f_T	> 100	> 100	MHz
C_{CBO}	12 (< 18)	12 (< 18)	pF
C_{EBO}	< 80	< 80	pF
NF	2 (< 10)	2 (< 10)	dB

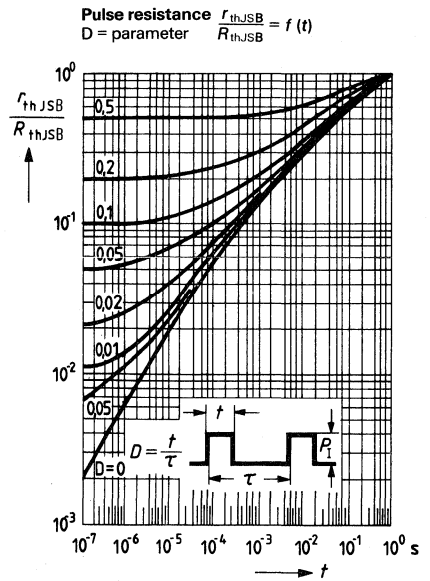
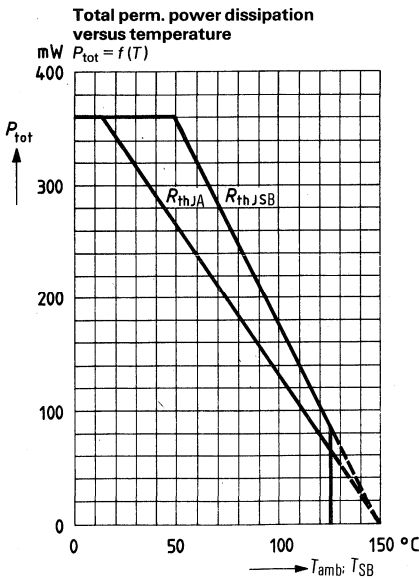

DC current gain $h_{FE} = f(I_C)$
 $V_{CE} = 1 \text{ V}; T_{amb} = \text{parameter}$

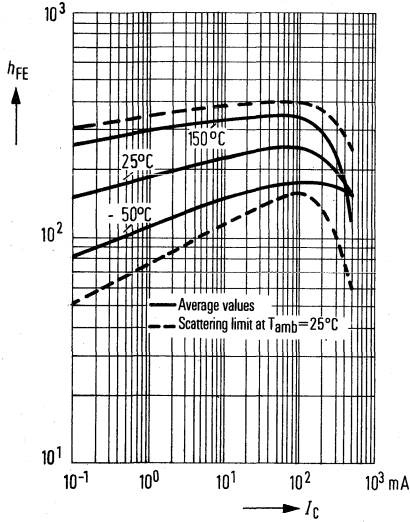

Output characteristics $I_C = f(V_{CE})$
 $I_B = \text{parameter}$
 (common emitter configuration)

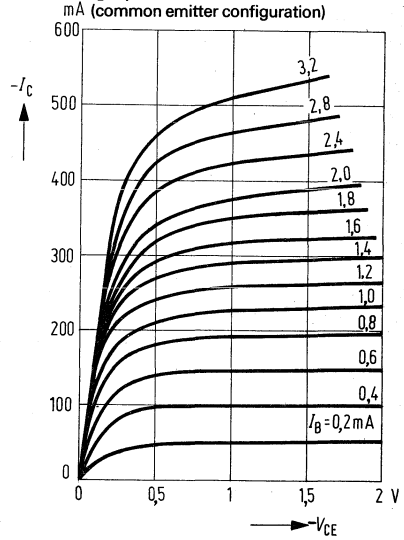

Collector cutoff current versus temperature $I_{CES} = f(T_{amb})$ for max. permissible reverse voltage

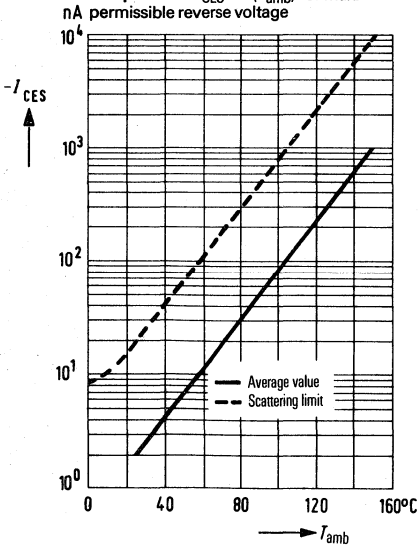

Collector current $I_C = f(V_{BE})$
 $V_{CE} = 1 \text{ V}; T_{amb} = \text{parameter}$

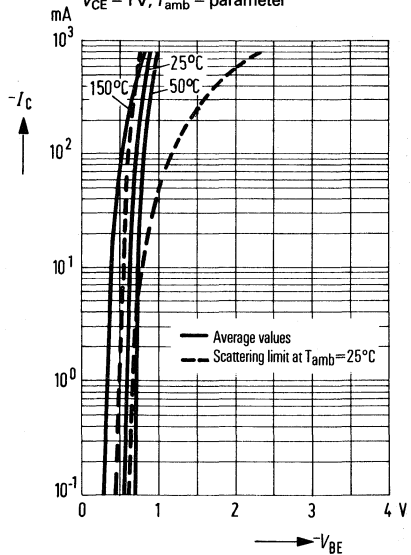

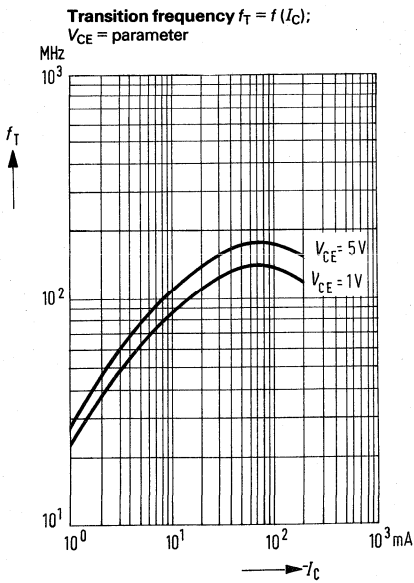
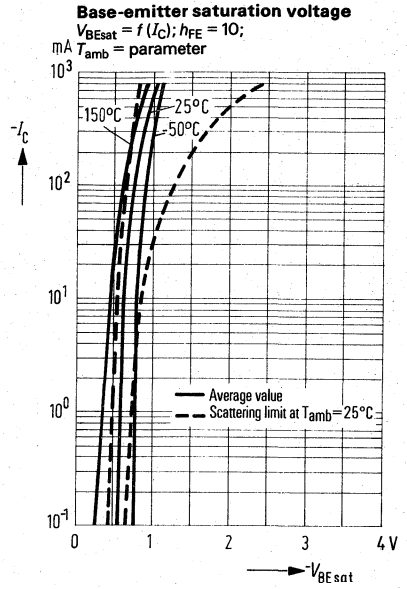
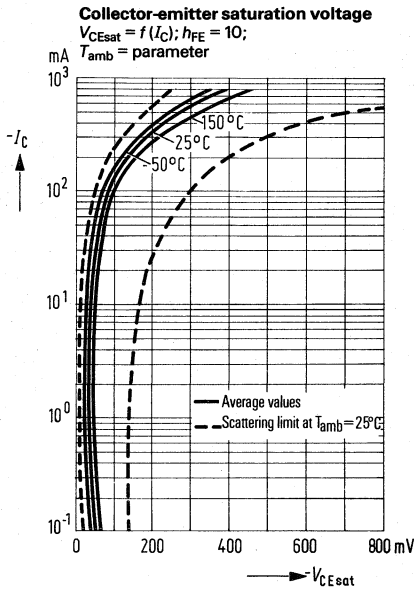

BCX 22, BCX 24, and BCX 94 are epitaxial NPN silicon planar transistors in TO 18 metal case (18 A 3 DIN 41876). The collector is electrically connected to the case. These transistors are particularly suitable for use in AF input and driver stages as well as for universal applications at higher reverse voltages.

Type	Ordering code
BCX 22	Q62702-C732
BCX 24	Q62702-C750
BCX 94	Q62702-C856

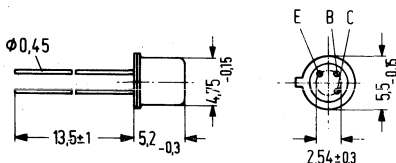

Approx. weight 0.33 g

Dimensions in mm

Maximum ratings ($T_{amb} = 25^{\circ}\text{C}$)		BCX 22	BCX 24	BCX 94	
Collector-emitter voltage	V_{CES}	125	100	100	V
Collector-emitter voltage	V_{CEO}	125	100	100	V
Emitter-base voltage	V_{EBO}	5	5	5	V
Collector current	I_C	800	800	800	mA
Collector peak current	I_{CM}	1	1	1	A
Base current	I_B	100	100	100	mA
Junction temperature	T_j	200	200	200	$^{\circ}\text{C}$
Storage temperature range	T_{stg}	-65 to +200	-65 to +200	-65 to +200	$^{\circ}\text{C}$
Total power dissipation ($T_{amb} = 25^{\circ}\text{C}$)	P_{tot}	450	450	450	mW
Total power dissipation ($T_{case} = 45^{\circ}\text{C}$)	P_{tot}	1.55	1.55	1.55	W

Thermal resistance

Junction to ambient air	R_{thJA}	< 390	< 390	< 390	K/W
Junction to case	R_{thJC}	< 100	< 100	< 100	K/W

Static characteristics ($T_{amb} = 25^{\circ}\text{C}$)		BCX 22	BCX 24	BCX 94	
Collector-emitter breakdown voltage ($I_C = 10\text{ mA}$)	$V_{(BR)CEO}$	> 125	> 100	> 100	V
Collector-emitter breakdown voltage ($I_C = 100\ \mu\text{A}$)	$V_{(BR)CES}$	> 125	> 100	> 100	V
Emitter-base breakdown voltage ($I_E = 100\ \mu\text{A}$)	$V_{(BR)EBO}$	> 5	> 5	> 5	V
Collector-emitter saturation voltage ($I_C = 300\text{ mA}$; $I_B = 30\text{ mA}$)	V_{CEsat}	≤ 0.9	≤ 0.9	< 0.9	V
Base-emitter saturation voltage ($I_C = 300\text{ mA}$; $I_B = 30\text{ mA}$)	V_{BEsat}	≤ 1.4	-	≤ 1.4	V
Base-emitter saturation voltage ($I_C = 100\ \mu\text{A}$; $I_B = 2.5\ \mu\text{A}$)	V_{BEsat}	-	≤ 1.5	-	V
Collector cutoff current ($V_{CES} = 100\text{ V}$)	I_{CES}	≤ 100	≤ 30	≤ 100	nA
Collector cutoff current ($V_{CES} = 100\text{ V}$; $T_{amb} = 150^{\circ}\text{C}$)	I_{CES}	≤ 10	≤ 10	≤ 10	μA
Emitter cutoff current ($V_{EB} = 4\text{ V}$)	I_{EBO}	≤ 100	≤ 100	≤ 100	nA
DC current gain ($I_C = 100\text{ mA}$; $V_{CE} = 1\text{ V}$)	h_{FE}	> 63	> 40	> 63	-
DC current gain ($I_C = 200\text{ mA}$; $V_{CE} = 1\text{ V}$)	h_{FE}	> 40	-	> 40	-
DC current gain ($I_C = 10\ \mu\text{A}$; $V_{CE} = 1\text{ V}$)	h_{FE}	-	≥ 20	-	-
DC current gain ($I_C = 100\ \mu\text{A}$; $V_{CE} = 1\text{ V}$)	h_{FE}	-	≥ 20	-	-

Dynamic characteristics ($T_{amb} = 25^{\circ}\text{C}$)					
Transition frequency ($I_C = 10\text{ mA}$; $V_{CE} = 5\text{ V}$; $f = 20\text{ MHz}$)	f_T	100	100	100	MH
Output capacitance ($V_{CB} = 10\text{ V}$; $I_E = 0$; $f = 1\text{ MHz}$)	C_{ob}	12	12	12	pF

Total perm. power dissipation versus temperature
 $P_{tot} = f(T); R_{th} = \text{parameter}$

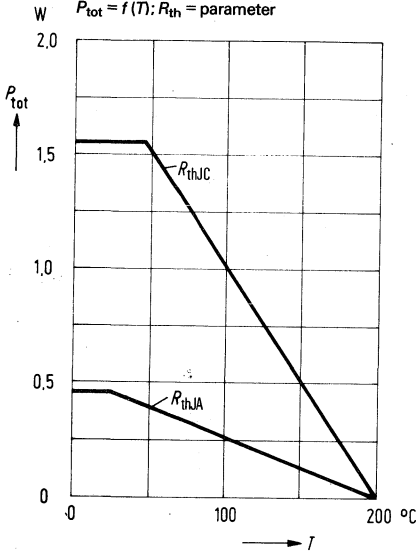

Permissible pulse load
 $r_{thJC} = f(t); v = \text{parameter}$

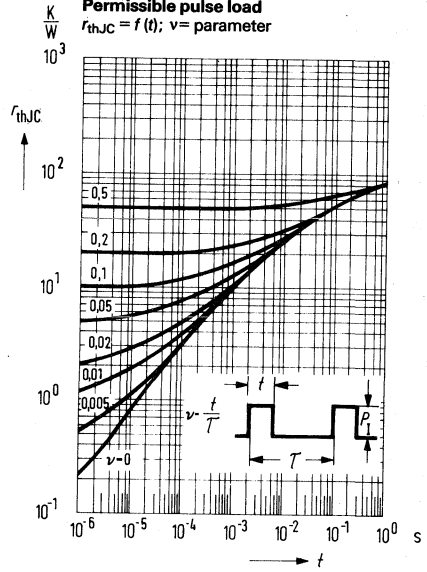

DC current gain $h_{FE} = f(I_C)$
 $T_{amb} = \text{parameter}; V_{CE} = 1V$

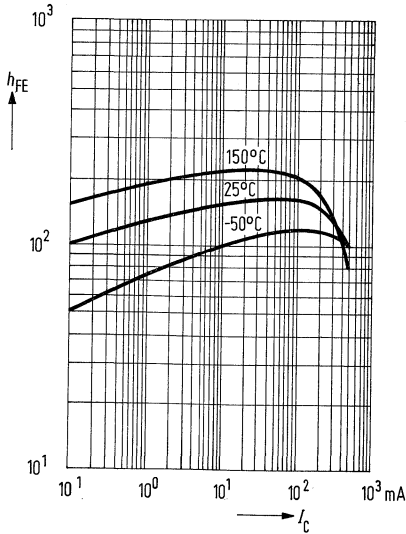

Collector current $I_C = f(V_{BE})$
 $T_{amb} = \text{parameter}$

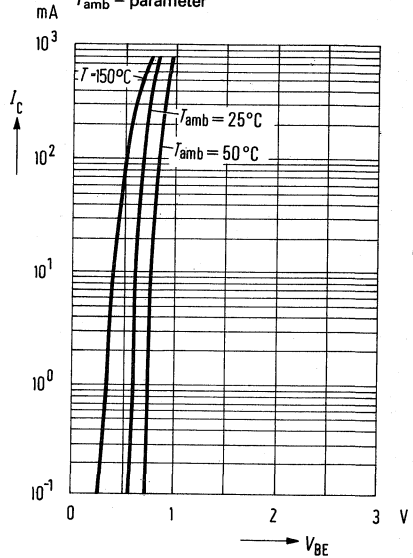

Collector cutoff current versus temperature $I_{CES} = f(T_{amb})$ for max. permissible reverse voltage

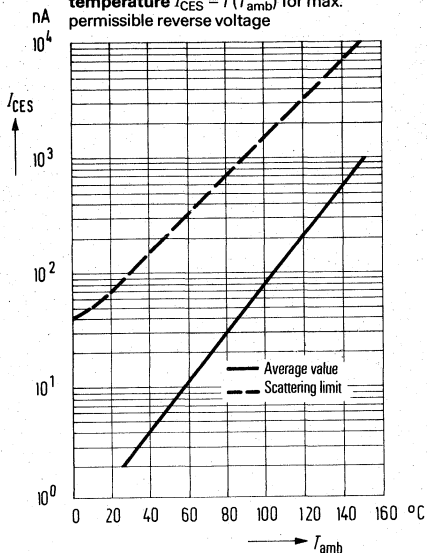

Transition frequency $f_T = f(I_C)$
 $V_{CE} = \text{parameter}; f_M = 20 \text{ MHz};$
 $T_{amb} = 25^\circ\text{C}$

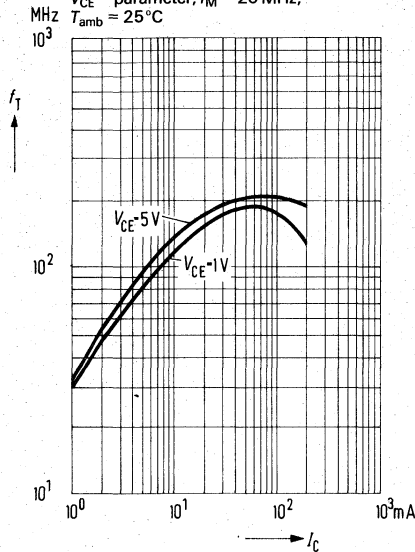

Collector-emitter saturation voltage

$V_{CESat} = f(I_C); h_{FE} = 10;$
 $T_{amb} = \text{parameter}$

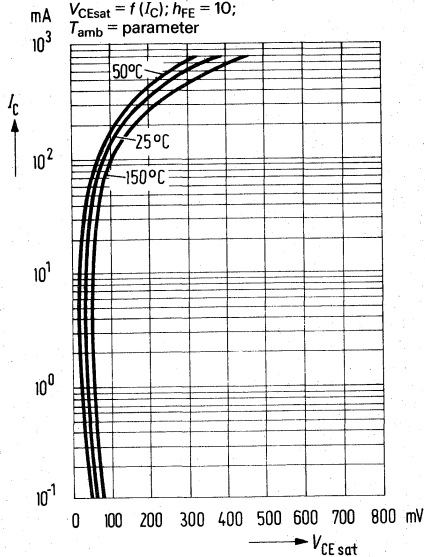

Base-emitter saturation voltage

$V_{BESat} = f(I_C); h_{FE} = 10; T_{amb} = \text{parameter}$

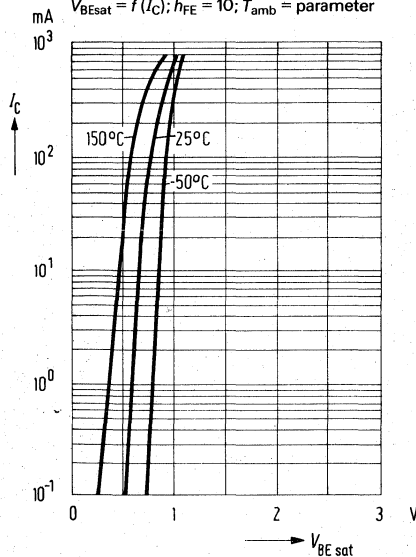

BCX 23 and BCX 39 are epitaxial PNP silicon planar transistors in TO 18 metal case (18 A 3 DIN 41876). The collector is electrically connected to the case. These transistors are particularly suitable for use in AF input and driver stages as well as for universal applications at higher reverse voltages.

Type	Ordering code
BCX 23	Q62702-C733
BCX 39	Q62702-C821

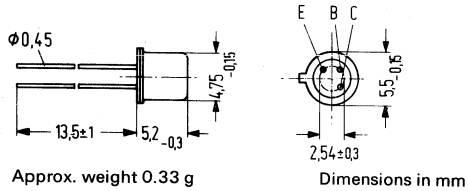

Maximum ratings ($T_{amb} = 25^{\circ}\text{C}$)

	BCX 23	BCX 39	
Collector-emitter voltage	- V_{CES} 125	100	V
Collector-emitter voltage	- V_{CEO} 125	100	V
Emitter-base voltage	- V_{EBO} 5	5	V
Collector current	- I_C 800	800	mA
Collector peak current	- I_{CM} 1	1	A
Base current	- I_B 100	100	mA
Junction temperature	T_j 200	200	$^{\circ}\text{C}$
Storage temperature range	T_{stg} -65 to +200	-65 to +200	$^{\circ}\text{C}$
Total power dissipation ($T_{amb} = 25^{\circ}\text{C}$)	P_{tot} 450	450	mW
Total power dissipation ($T_{case} = 45^{\circ}\text{C}$)	P_{tot} 1.55	1.55	W

Thermal resistance

Junction to ambient air	R_{thJA}	< 390	< 390	K/W
Junction to case	R_{thJC}	< 100	< 100	K/W

Static characteristics ($T_{amb} = 25^{\circ}\text{C}$)

Collector-emitter breakdown voltage

($-I_C = 10\text{ mA}$)

	BCX 23	BCX 39	
$-V_{(BR)CEO}$	> 125	> 100	V
Collector-emitter breakdown voltage			
($-I_C = 100\ \mu\text{A}$)			
$-V_{(BR)CES}$	> 125	> 100	V
Emitter-base breakdown voltage			
($-I_E = 100\ \mu\text{A}$)			
$-V_{(BR)EBO}$	> 5	> 5	V
Collector-emitter saturation voltage			
($-I_C = 300\text{ mA}$; $-I_B = 30\text{ mA}$)			
$-V_{CEsat}$	≤ 0.9	≤ 0.9	V
Base-emitter saturation voltage			
($-I_C = 300\text{ mA}$; $-I_B = 30\text{ mA}$)			
$-V_{BEsat}$	≤ 1.4	≤ 1.4	V
Collector cutoff current			
($-V_{CES} = 100\text{ V}$)			
$-I_{CES}$	≤ 100	≤ 100	nA
($-V_{CES} = 100\text{ V}$); $T_{amb} = 150^{\circ}\text{C}$)			
$-I_{CES}$	≤ 10	≤ 10	μA
Emitter cutoff current			
($-V_{EB} = 4\text{ V}$)			
$-I_{EBO}$	≤ 100	≤ 100	nA
DC current gain			
($-I_C = 100\text{ mA}$; $-V_{CE} = 1\text{ V}$)			
h_{FE}	≥ 63	> 63	-
($-I_C = 200\text{ mA}$; $-V_{CE} = 1\text{ V}$)			
h_{FE}	≥ 40	> 40	-

Dynamic characteristics ($T_{amb} = 25^{\circ}\text{C}$)

Transition frequency

($-I_C = 10\text{ mA}$; $-V_{CE} = 5\text{ V}$; $f = 20\text{ MHz}$)

f_T	100	100	MHz
Output capacitance			
($-V_{CB} = 10\text{ V}$; $-I_E = 0$; $f = 1\text{ MHz}$)			
C_{ob}	12	12	pF

Total perm. power dissipation versus temperature
 $P_{tot} = f(T); R_{th} = \text{parameter}$

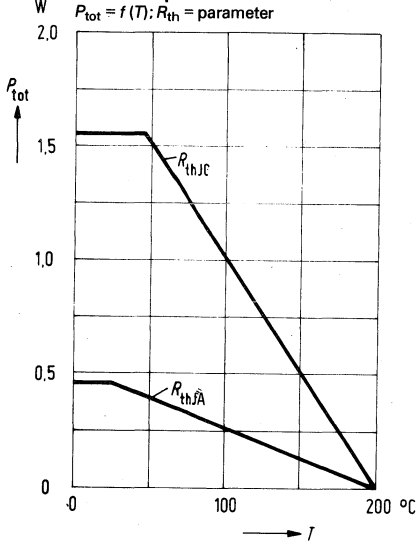

Permissible pulse load
 $r_{thJC} = f(t); v = \text{parameter}$

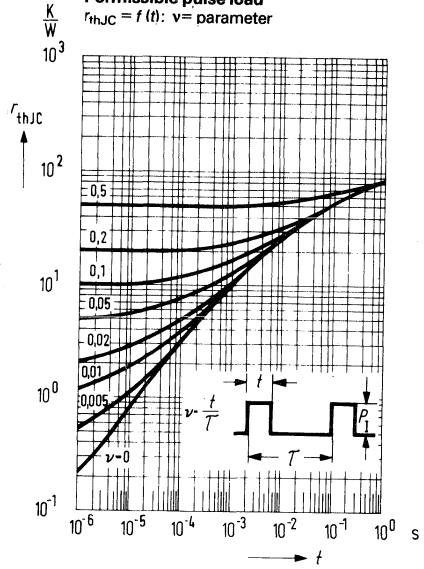

DC current gain $h_{FE} = f(I_C)$
 $T_{amb} = \text{parameter}; V_{CE} = 1V$

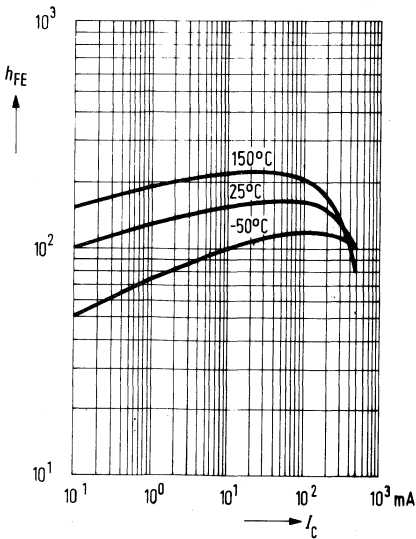

Collector current $I_C = f(V_{BE})$
 $T_{amb} = \text{parameter}$

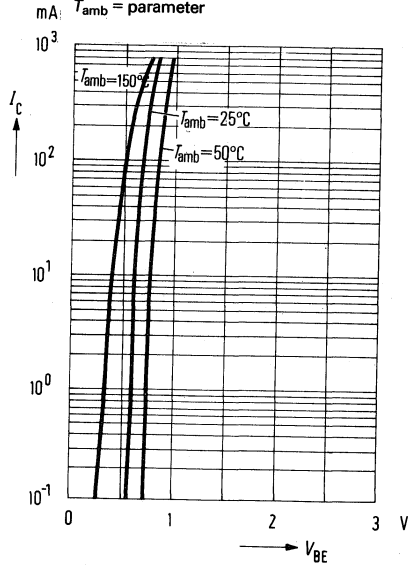

Collector cutoff current versus temperature $I_{CES} = f(T_{amb})$ for max. permissible reverse voltage

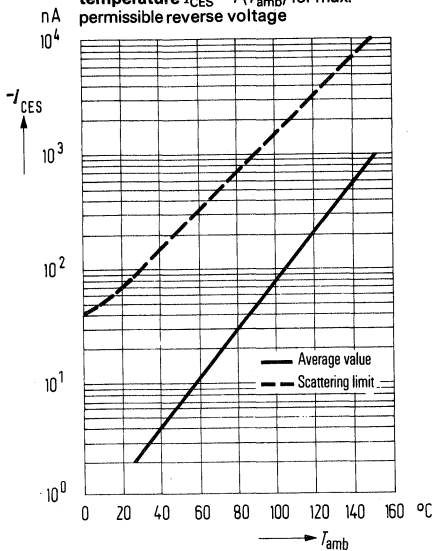

Transition frequency $f_T = f(I_C)$
 $V_{CE} = \text{parameter}; f_M = 20 \text{ MHz}; T_{amb} = 25^\circ\text{C}$

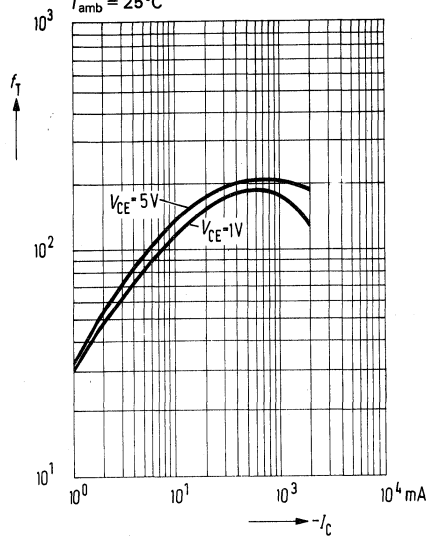

Collector-emitter saturation voltage $V_{CEsat} = f(I_C); h_{FE} = 10; T_{amb} = \text{parameter}$

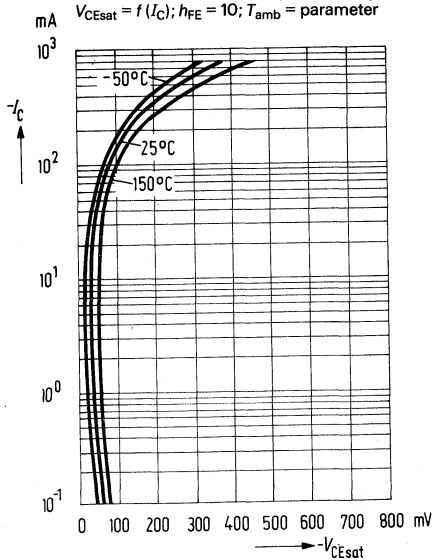

Base-emitter saturation voltage $V_{BEsat} = f(I_C); h_{FE} = 10; T_{amb} = \text{parameter}$

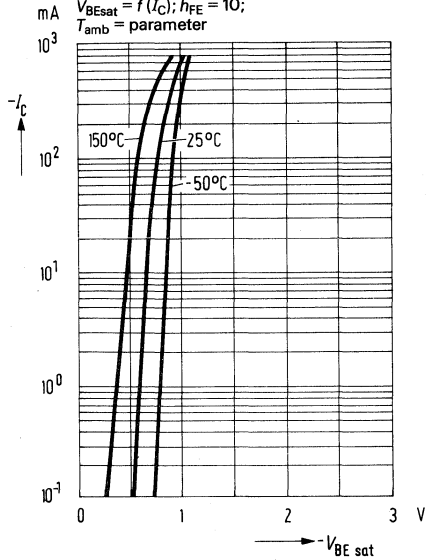

BCX 41 is an epitaxial NPN silicon planar transistor in TO 236 plastic package (23 A 3 DIN 41869). This transistor is intended for use in AF input and driver stages as well as for universal applications at higher reverse voltages in thin and thick film circuits. The transistor is marked by the code letters ›EK‹.

The transistor is also available – if required – with changed terminal sequence (›E‹ and ›B‹ interchanged) under the designation BCX 41 R (marked ›ES‹).

Type	Mark	Ordering code
BCX 41	EK	Q62702-C946
BCX 41 R	ES	Q62702-C1061

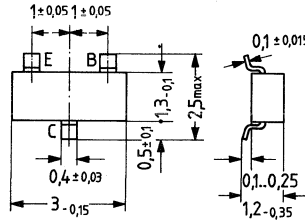

Approx. weight 0.02 g Dimensions in mm

Maximum ratings ($T_{amb} = 25^{\circ}\text{C}$)

Collector-emitter voltage	V_{CEO}	125	V
Collector-base voltage	V_{CBO}	125	V
Emitter-base voltage	V_{EBO}	5	V
Collector current	I_C	800	mA
Collector peak current ($t < 10$ ms)	I_{CM}	1	A
Base current	I_B	100	mA
Junction temperature	T_j	150	$^{\circ}\text{C}$
Storage temperature range	T_{stg}	-55 to +125	$^{\circ}\text{C}$
Total power dissipation ($T_{SB} = 50^{\circ}\text{C}$)	P_{tot}	350	mW

Thermal resistance

Junction to ambient air	R_{thJA}	< 380	K/W
Junction to substrate back ¹⁾	R_{thJSB}	< 285	K/W

1) Ceramic substrate 0.7 mm; 2.5 cm² area

Static characteristics ($T_{amb} = 25^{\circ}\text{C}$)

Collector-emitter breakdown voltage ($I_C = 10\text{ mA}$)	$V_{(BR)CEO}$	> 125	V
Collector-emitter breakdown voltage ($I_C = 100\text{ }\mu\text{A}$)	$V_{(BR)CES}$	> 125	V
Emitter-base breakdown voltage ($I_C = 100\text{ }\mu\text{A}$)	$V_{(BR)EBO}$	> 5	V
Collector-emitter saturation voltage ($I_C = 300\text{ mA}$; $I_B = 30\text{ mA}$)	V_{CESat}	< 0.9	V
Base-emitter saturation voltage ($I_C = 300\text{ mA}$; $I_B = 30\text{ mA}$)	V_{BEsat}	< 1.4	V
Collector cutoff current ($V_{CES} = 100\text{ V}$)	I_{CES}	< 100	nA
($V_{CES} = 100\text{ V}$; $T_{amb} = 150^{\circ}\text{C}$)	I_{CES}	< 10	μA
($V_{CES} = 100\text{ V}$; $T_{amb} = 85^{\circ}\text{C}$; $V_{BE} = 0.2\text{ V}$)	I_{CEX}	< 10	μA
($V_{CES} = 100\text{ V}$; $T_{amb} = 125^{\circ}\text{C}$; $V_{BE} = 0.2\text{ V}$)	I_{CEX}	< 75	μA
Emitter cutoff current ($V_{EB} = 4\text{ V}$)	I_{EBO}	< 100	nA
DC current gain ($I_C = 100\text{ }\mu\text{A}$; $V_{CE} = 1\text{ V}$)	h_{FE}	> 25	–
($I_C = 100\text{ mA}$; $V_{CE} = 1\text{ V}$)	h_{FE}	> 63	–
($I_C = 200\text{ mA}$; $V_{CE} = 1\text{ V}$)	h_{FE}	> 40	–

Dynamic characteristics ($T_{amb} = 25^{\circ}\text{C}$)

Transition frequency ($I_C = 10\text{ mA}$; $V_{CE} = 5\text{ V}$; $f = 20\text{ MHz}$)	f_T	100	MHz
Output capacitance ($V_{CB} = 10\text{ V}$; $I_E = 0$; $f = 1\text{ MHz}$)	C_{ob}	12	pF

Total perm. power dissipation versus temperature
 $P_{tot} = f(T)$

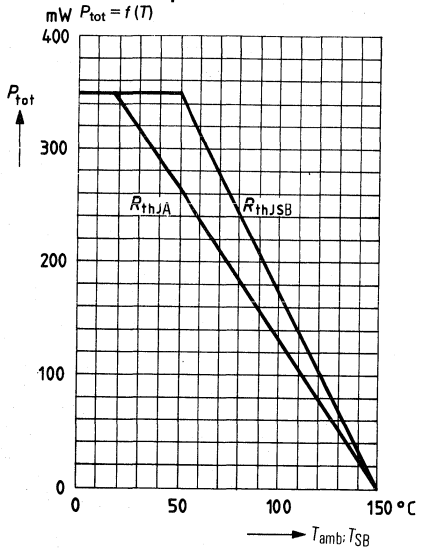

Pulse resistance $r_{thJSB} = f(t)$
 $D = \text{parameter}$ $\frac{r_{thJSB}}{R_{thJSB}} = f(t)$

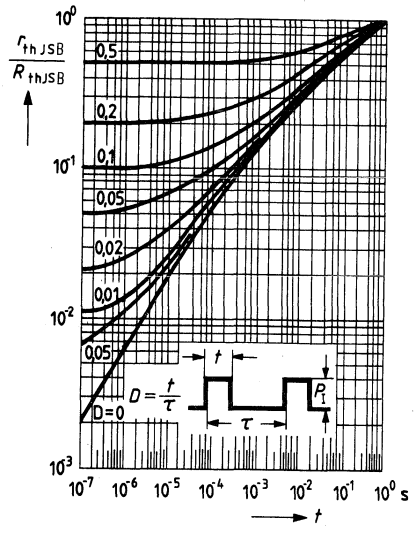

DC current gain $h_{FE} = f(I_C)$
 $T_{amb} = \text{parameter}; V_{CE} = 1V$

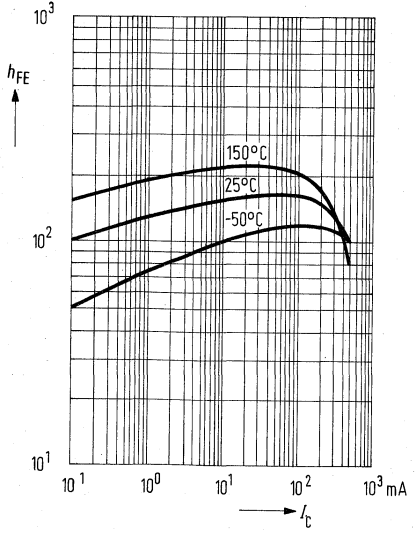

Collector cutoff current versus temperature $I_{CES} = f(T_{amb})$ for max. permissible reverse voltage

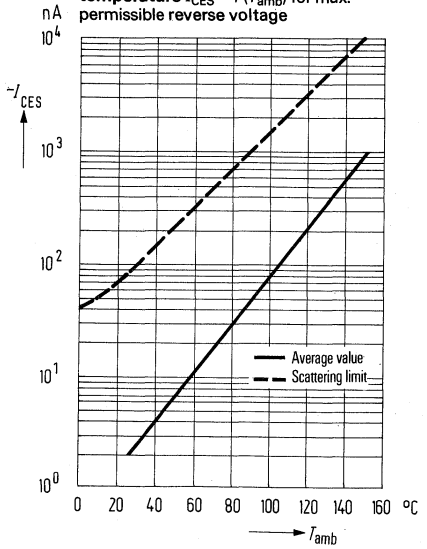

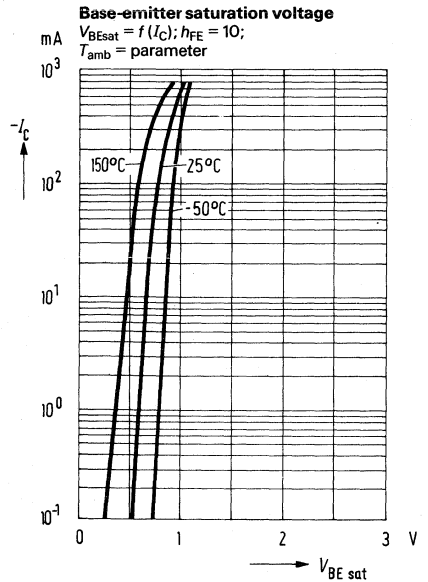
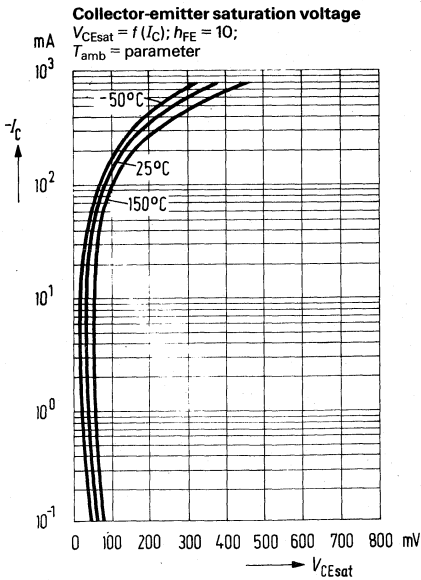
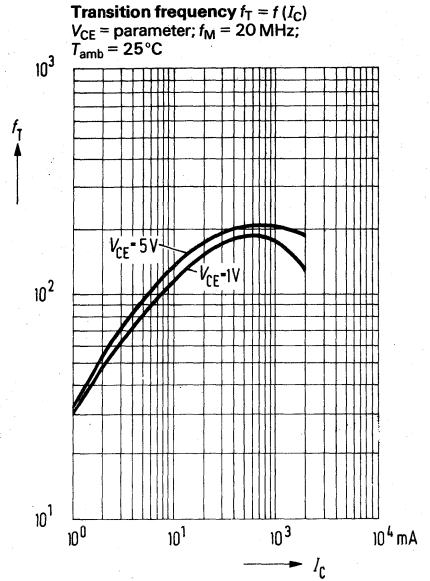
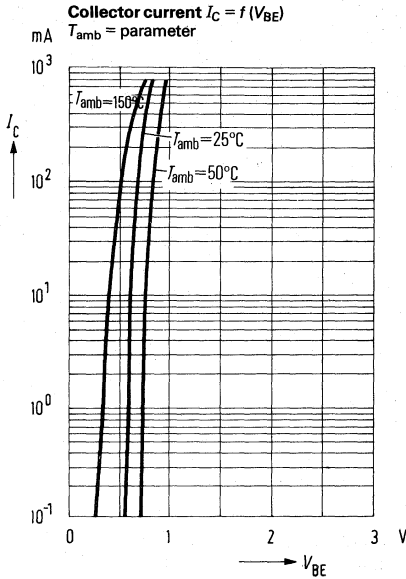

BCX 42 is an epitaxial PNP silicon planar transistor in TO 236 plastic package (23 A 3 DIN 41 869). This transistor is intended for use in AF input and driver stages as well as for universal applications at higher reverse voltages in thin and thick film circuits. The transistor is marked by the code letters >DK<.

The transistor is also available – if required – with changed terminal sequence (>E< and >B< interchanged) under the designation BCX 42 R (marked >DS<).

Type	Mark	Ordering code
BCX 42	DK	Q62702-C945
BCX 42 R	DS	Q62702-C1062

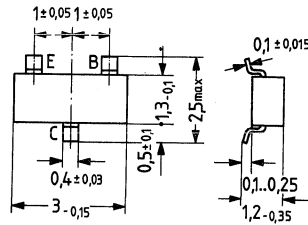

Approx. weight 0.02 g
Dimensions in mm

Maximum ratings ($T_{amb} = 25^{\circ}\text{C}$)

Collector-emitter voltage	$-V_{CE0}$	125	V
Collector-base voltage	$-V_{CBO}$	125	V
Emitter-base voltage	$-V_{EBO}$	5	V
Collector current	$-I_C$	0.8	A
Collector peak current ($t < 10$ ms)	$-I_{CM}$	1	A
Base current	$-I_B$	100	mA
Junction temperature	T_j	150	$^{\circ}\text{C}$
Storage temperature range	T_{stg}	-55 to +125	$^{\circ}\text{C}$
Total power dissipation ($T_{SB} = 50^{\circ}\text{C}$)	P_{tot}	350	mW

Thermal resistance

Junction to ambient air	R_{thJA}	<380	K/W
Junction to substrate back ¹⁾	R_{thJSB}	<285	K/W

1) Ceramic substrate 0.7 mm; 2.5 cm² area

Static characteristics ($T_{amb} = 25^{\circ}\text{C}$)

Collector-emitter breakdown voltage ($-I_C = 10\text{ mA}$)	$-V_{(BR)CEO}$	> 125	V
Collector-emitter breakdown voltage ($-I_C = 100\text{ }\mu\text{A}$)	$-V_{(BR)CES}$	> 125	V
Emitter-base breakdown voltage ($-I_C = 100\text{ }\mu\text{A}$)	$-V_{(BR)EBO}$	> 5	V
Collector-emitter saturation voltage ($-I_C = 300\text{ mA}$; $-I_B = 30\text{ mA}$)	$-V_{CEsat}$	< 0.9	V
Base-emitter saturation voltage ($-V_{CES} = 300\text{ mA}$; $-I_B = 30\text{ mA}$)	$-V_{BEsat}$	< 1.4	V
Collector cutoff current ($-V_{CES} = 100\text{ V}$)	$-I_{CES}$	< 100	nA
($-V_{CES} = 100\text{ V}$; $T_{amb} = 150^{\circ}\text{C}$)	$-I_{CES}$	< 10	μA
($-V_{CES} = 100\text{ V}$; $T_{amb} = 85^{\circ}\text{C}$; $-V_{BE} = 0.2\text{ V}$)	$-I_{CEX}$	< 10	μA
($-V_{CES} = 100\text{ V}$; $T_{amb} = 125^{\circ}\text{C}$; $-V_{BE} = 0.2\text{ V}$)	$-I_{CEX}$	< 75	μA
Emitter cutoff current ($-V_{EB} = 4\text{ V}$)	$-I_{EBO}$	< 100	nA
DC current gain ($-I_C = 100\text{ }\mu\text{A}$; $-V_{CE} = 1\text{ V}$)	h_{FE}	> 30	-
($-I_C = 100\text{ mA}$; $-V_{CE} = 1\text{ V}$)	h_{FE}	> 63	-
($-I_C = 200\text{ mA}$; $-V_{CE} = 1\text{ V}$)	h_{FE}	> 40	-

Dynamic characteristics

Transition frequency ($-I_C = 10\text{ mA}$; $-V_{CE} = 5\text{ V}$; $f = 20\text{ MHz}$)	f_T	100	MHz
Output capacitance ($-V_{CB} = 10\text{ V}$; $I_E = 0$; $f = 1\text{ MHz}$)	C_{ob}	12	pF

Total perm. power dissipation versus temperature
 $P_{tot} = f(T_{amb})$

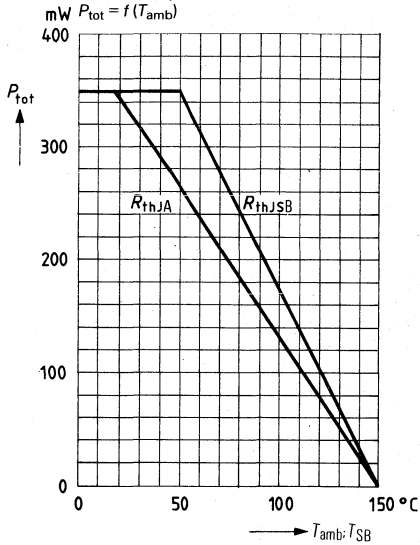

Pulse resistance $r_{thJSB} = f(t)$
 $D = \text{parameter}$ $\frac{r_{thJSB}}{R_{thJSB}} = f(t)$

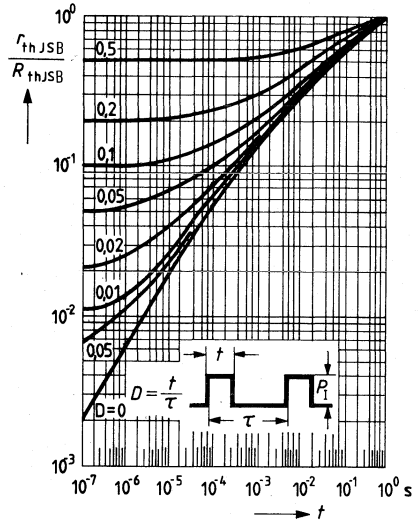

DC current gain $h_{FE} = f(I_C)$
 $V_{CE} = 1V$; $T_{amb} = \text{parameter}$

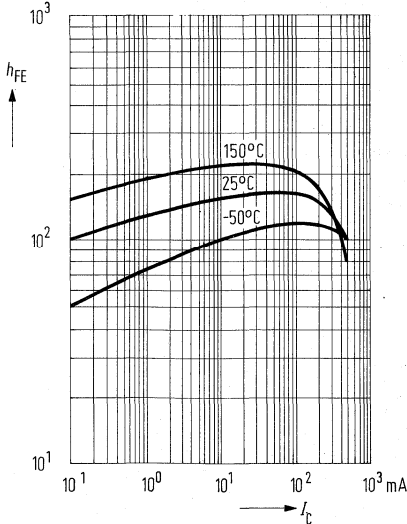

Collector cutoff current versus temperature
 $I_{CES} = f(T_{amb})$ for max. permissible reverse voltage

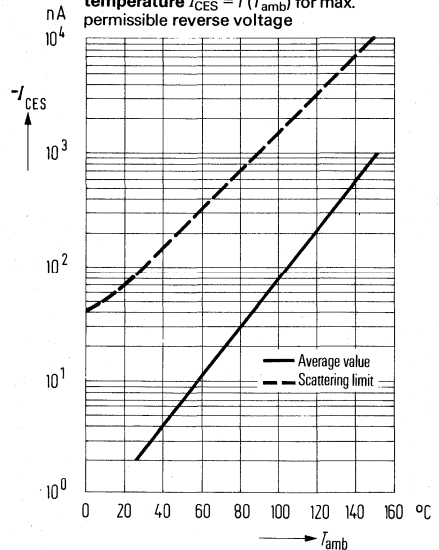

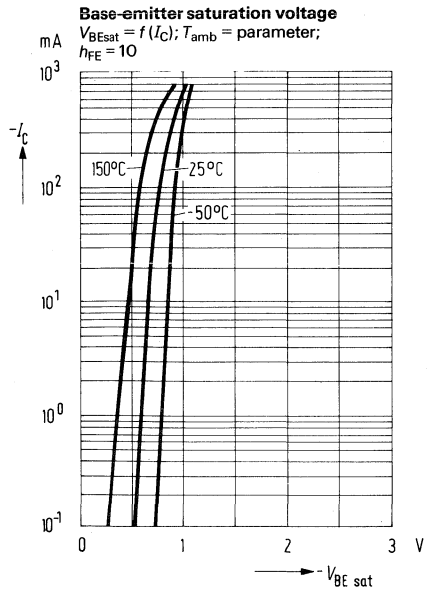
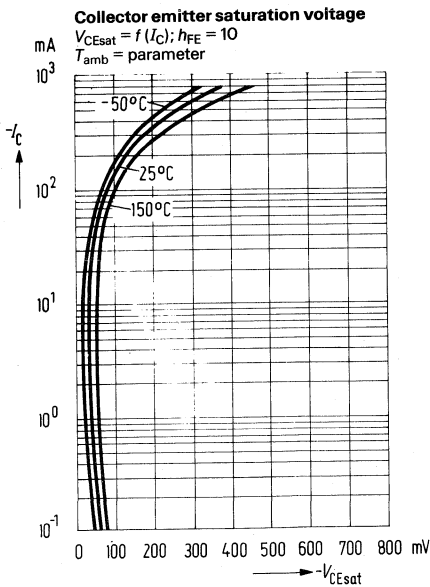
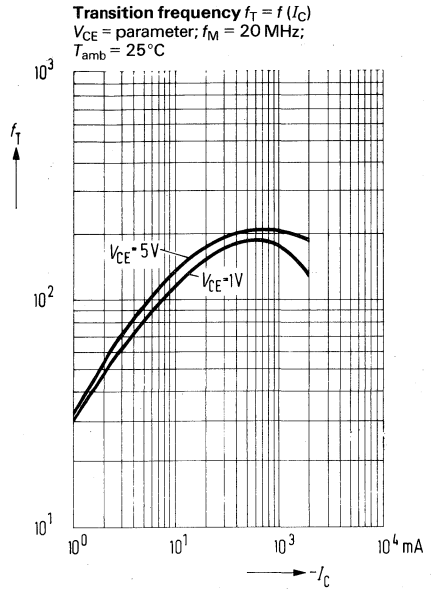
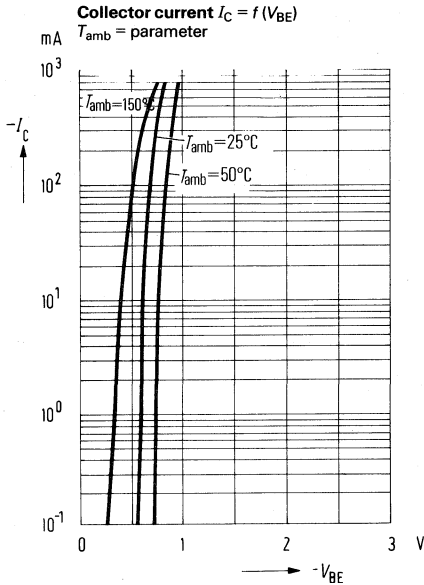

BCX 51, BCX 52, and BCX 53 are epitaxial PNP silicon planar transistors in SOT 89 plastic package. These transistors are particularly suitable for use in AF input and driver stages of low and medium performance in thin and thick film circuits. Complementary transistors are BCX 54, BCX 55, and BCX 56. The transistors are marked by the following code letters:

Type	Mark	Ordering code
BCX 51	AA	Q62702-C951
BCX 51-6	AB	Q62702-C1063
BCX 51-10	AC	Q62702-C1064
BCX 51-16	AD	Q62702-C1065
BCX 52	AE	Q62702-C950
BCX 52-6	AF	Q62702-C1066
BCX 52-10	AG	Q62702-C1067
BCX 53	AH	Q62702-C952
BCX 53-6	AJ	Q62702-C1068
BCX 53-10	AK	Q62702-C1069

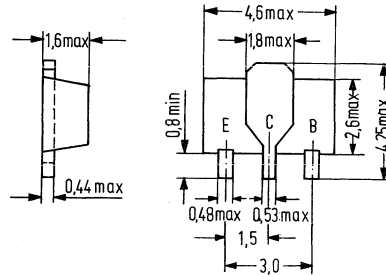

Approx. weight 0.1 g

Dimensions in mm

Maximum ratings ($T_{amb} = 25^{\circ}\text{C}$)

		BCX 51	BCX 52	BCX 53	
Collector-emitter voltage	$-V_{CEO}$	45	60	80	V
Collector-base voltage	$-V_{CBO}$	45	60	100	V
Emitter-base voltage	$-V_{EBO}$	5	5	5	V
Collector current	$-I_C$	1	1	1	A
Collector peak current	$-I_{CM}$	1.5	1.5	1.5	A
Base current	$-I_B$	100	100	100	mA
Base peak current	$-I_{BM}$	200	200	200	mA
Junction temperature	$-T_j$	150	150	150	$^{\circ}\text{C}$
Storage temperature range	T_{stg}	-65 to +150			$^{\circ}\text{C}$
Total power dissipation ($T_{SB} = 60^{\circ}\text{C}$) (ceramic substrate 0.7 mm with 2.5 cm ² area)		3	3	3	W

Thermal resistance

Junction to substrate back
(ceramic substrate
0.7 mm with 2.5 cm² area)

R_{thJSB}	BCX 51	BCX 52	BCX 53	Unit
	≤ 30	≤ 30	≤ 30	K/W

Static characteristics ($T_{amb} = 25^{\circ}\text{C}$)		BCX 51	BCX 52	BCX 53	
Collector-emitter saturation voltage ($-I_C = 500\text{ mA}$; $-I_B = 50\text{ mA}$)					
	$-V_{CEsat}$	≤ 0.5	≤ 0.5	≤ 0.5	V
Base-emitter voltage ($-V_{CE} = 2\text{ V}$; $-I_C = 500\text{ mA}$)					
	$-V_{BE}$	≤ 1	≤ 1	≤ 1	V
Collector cutoff current ($-V_{CB} = 30\text{ V}$)					
	$-I_{CBO}$	≤ 100	≤ 100	≤ 100	nA
DC current gain ($-V_{CE} = 2\text{ V}$; $-I_C = 5\text{ mA}$)					
	h_{FE}	> 25	> 25	> 25	-
DC current gain ($-V_{CE} = 2\text{ V}$; $-I_C = 150\text{ mA}$)					
	h_{FE}	40 to 250	40 to 160	40 to 160	-
DC current gain ($-V_{CE} = 2\text{ V}$; $-I_C = 500\text{ mA}$)					
	h_{FE}	25	25	25	-

Dynamic characteristics

Transition frequency ($-V_{BE} = 5\text{ V}$; $-I_C = 10\text{ mA}$; $f = 35\text{ MHz}$)					
	f_T	50	50	50	MHz

Total perm. power dissipation versus temperature
 $P_{tot} = f(T_{SB})$

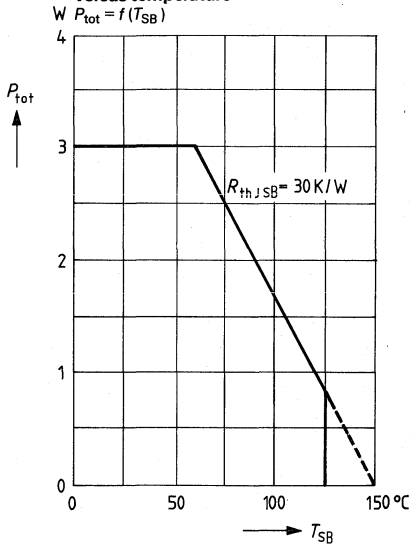

Permissible pulse load
 $r_{th,JSB} = f(t) \quad v = \text{parameter}$

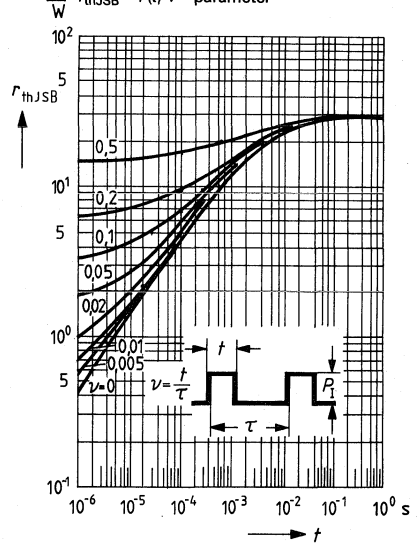

Output characteristics $I_C = f(V_{CE})$
 $I_B = \text{parameter}$

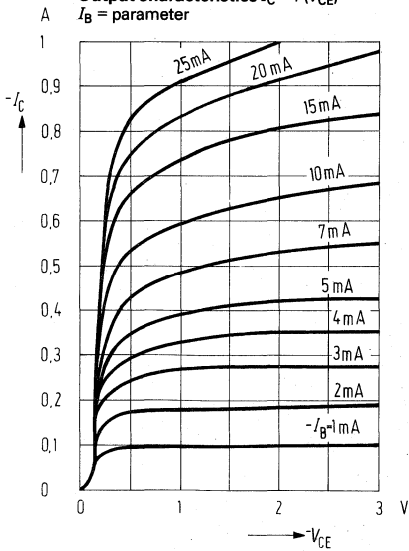

Output characteristics $I_C = f(V_{CE})$
 $I_B = \text{parameter}$

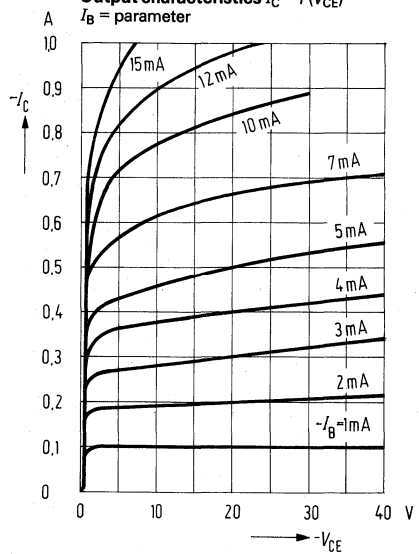

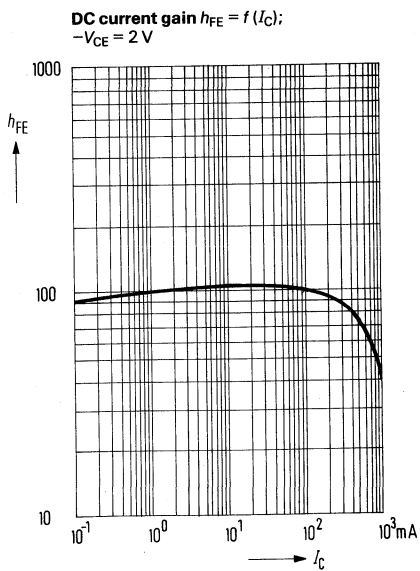
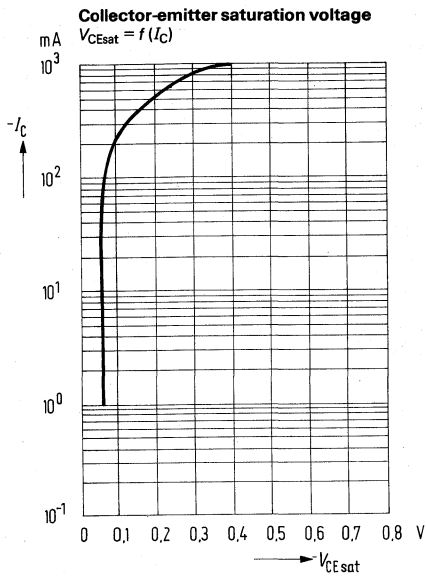
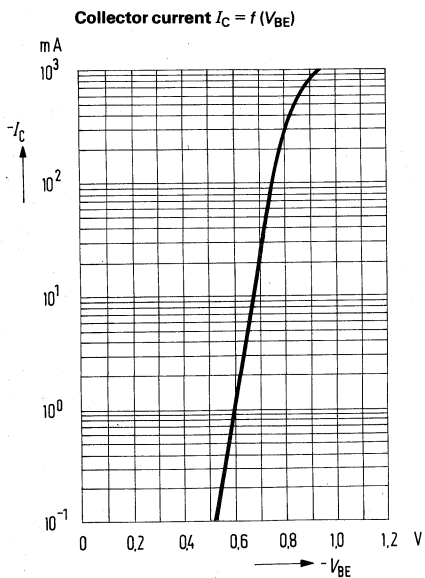

BCX 54, BCX 55, and BCX 56 are epitaxial NPN silicon planar transistors in SOT 89 plastic package. These transistors are particularly suitable for use in AF input and driver stages of low and medium performance in thin and thick film circuits. Complementary transistors are BCX 51, BCX 52, and BCX 53. The transistors are marked by the following code letters:

Type	Mark	Ordering code
BCX 54	BA	Q62702-C954
BCX 54-6	BB	Q62702-C1070
BCX 54-10	BC	Q62702-C1071
BCX 54-16	BD	Q62702-C1072
BCX 55	BE	Q62702-C955
BCX 55-6	BF	Q62702-C1073
BCX 55-10	BG	Q62702-C1074
BCX 56	BH	Q62702-C953
BCX 56-6	BJ	Q62702-C1075
BCX 56-10	BK	Q62702-C1076

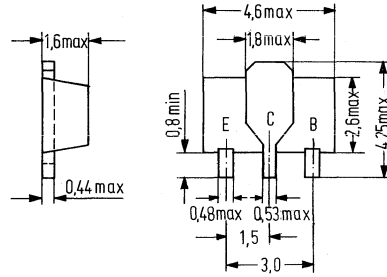

Approx. weight 0.1 g

Dimensions in mm

Maximum ratings ($T_{amb} = 25^{\circ}\text{C}$)		BCX 54	BCX 55	BCX 56	
Collector-emitter voltage	V_{CEO}	45	60	80	V
Collector-base voltage	V_{CBO}	45	60	100	V
Emitter-base voltage	V_{EBO}	5	5	5	V
Collector current	I_C	1	1	1	A
Collector peak current	I_{CM}	1.5	1.5	1.5	A
Base current	I_B	100	100	100	mA
Base peak current	I_{BM}	200	200	200	mA
Junction temperature	T_j	150	150	150	$^{\circ}\text{C}$
Storage temperature range	T_{stg}		-65 to +150		$^{\circ}\text{C}$
Total power dissipation ($T_{SB} = 60^{\circ}\text{C}$) (ceramic substrate 0.7 mm with 2.5 cm ² area)	P_{tot}	3	3	3	W

Thermal resistance

Junction to substrate back (ceramic substrate 0.7 mm with 2.5 cm ² area)	R_{thJSB}	≤ 30	≤ 30	≤ 30	K/W
---	-------------	-----------	-----------	-----------	-----

Static characteristics ($T_{amb} = 25\text{ }^{\circ}\text{C}$)		BCX 54	BCX 55	BCX 56		
Collector-emitter saturation voltage ($I_C = 500\text{ mA}$; $I_B = 50\text{ mA}$)		V_{CEsat}	≤ 0.5	≤ 0.5	≤ 0.5	V
Base-emitter voltage ($V_{CE} = 2\text{ V}$; $I_C = 500\text{ mA}$)		V_{BE}	≤ 1	≤ 1	≤ 1	V
Collector cutoff current ($V_{CB} = 30\text{ V}$)		I_{CBO}	≤ 100	≤ 100	≤ 100	nA
DC current gain ($V_{CE} = 2\text{ V}$; $I_C = 5\text{ mA}$)		h_{FE}	> 25	> 25	> 25	–
DC current gain ($V_{CE} = 2\text{ V}$; $I_C = 150\text{ mA}$)		h_{FE}	40 to 250	40 to 160	40 to 160	–
DC current gain ($V_{CE} = 2\text{ V}$; $I_C = 500\text{ mA}$)		h_{FE}	25	25	25	–
Dynamic characteristics						
Transition frequency ($V_{BE} = 5\text{ V}$; $I_C = 10\text{ mA}$; $f = 35\text{ MHz}$)		f_T	50	50	50	MHz

Total perm. power dissipation versus temperature
 $P_{tot} = f(T_{SB})$

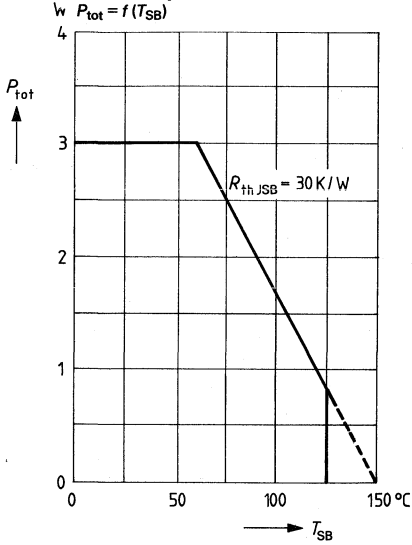

Permissible pulse load
 $r_{thJSB} = f(t) \nu = \text{parameter}$

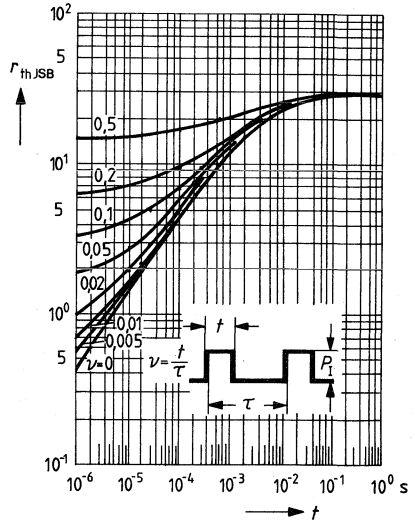

Output characteristics $I_C = f(V_{CE})$
 $I_B = \text{parameter}$

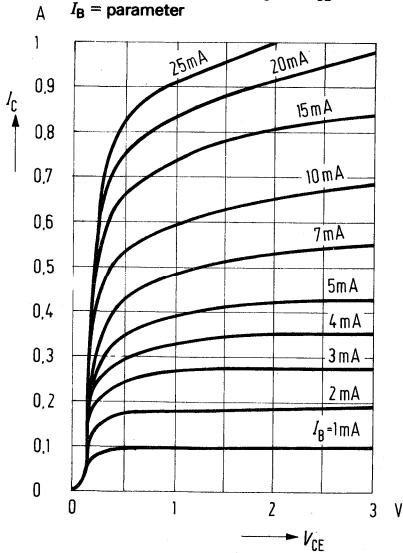

Output characteristics $I_C = f(V_{CE})$
 $I_B = \text{parameter}$

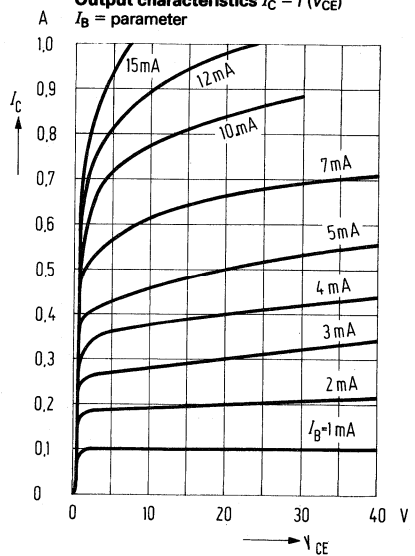

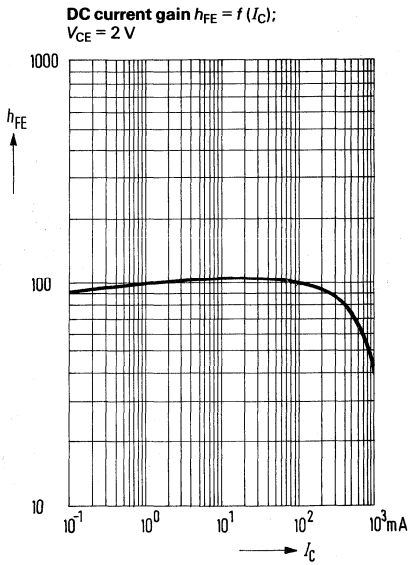
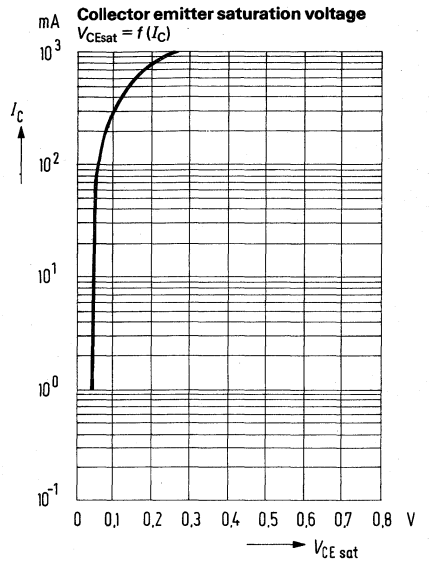
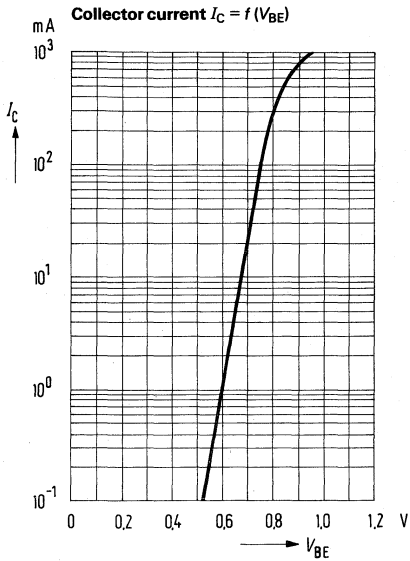

BCX 58 and BCX 59 are epitaxial NPN silicon planar transistors in 10 A 3 DIN 41868 plastic package (similar to TO 92). The transistors are designed for use in AF input and driver stages as well as for switching applications. Complementary transistors are BCX 78 and BCX 79.

Type	Ordering code
BCX 58	Q62702-C715
BCX 58 VII	Q62702-C618
BCX 58 VIII	Q62702-C619
BCX 58 IX	Q62702-C620
BCX 58 X	Q62702-C621
BCX 59	Q62702-C716
BCX 59 VII	Q62702-C622
BCX 59 VIII	Q62702-C623
BCX 59 IX	Q62702-C624
BCX 59 X	Q62702-C625

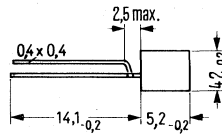

Approx. weight 0.25 g
Mounting instruction: Fixing hole dia 0.6

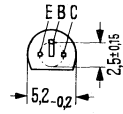

Dimensions in mm

Maximum ratings

Collector-emitter voltage	V_{CE0}	32	45	V
Collector-emitter voltage	V_{CES}	32	45	V
Emitter-base voltage	V_{EBO}	7	7	V
Collector current	I_C	100	100	mA
Collector peak current	I_{CM}	200	200	mA
Base current	I_B	50	50	mA
Junction temperature	T_j	150	150	°C
Storage temperature range	T_{stg}	-55 to +150		°C
Total power dissipation ($T_{amb} < 25^\circ\text{C}$)	P_{tot}	450	450	mW

	BCX 58	BCX 59	
V_{CE0}	32	45	V
V_{CES}	32	45	V
V_{EBO}	7	7	V
I_C	100	100	mA
I_{CM}	200	200	mA
I_B	50	50	mA
T_j	150	150	°C
T_{stg}	-55 to +150		°C
P_{tot}	450	450	mW

Thermal resistance

Junction to ambient air	R_{thJA}	<280	<280	K/W
-------------------------	------------	------	------	-----

Static characteristics ($T_{amb} = 25\text{ }^{\circ}\text{C}$):

Type	BCX 58, BCX 59				BCX 58	
	VII	VIII	IX	X	BCX 59	
h_{FE} group	h_{FE} I_C/I_B	h_{FE} I_C/I_B	h_{FE} I_C/I_B	h_{FE} I_C/I_B	V_{BE} (V)	
5	0.01	78	145 (>20)	220 (>40)	300 (>100)	0.5
5	2	170 (120 to 220)	250 (180 to 310)	350 (250 to 460)	500 (380 to 630)	0.62 (0.55 to 0.7)
1	10	190 (>80)	260 (120 to 400)	380 (160 to 630)	550 (240 to 1000)	0.7
1	100	>40	>45	>60	>60	0.83

Saturation voltages:

($I_C = 100\text{ mA}$; $I_B = 2.5\text{ mA}$)

($I_C = 100\text{ mA}$; $I_B = 2.5\text{ mA}$)

Collector-base capacitance

($V_{CBO} = 10\text{ V}$; $f = 1\text{ MHz}$)

Emitter-base capacitance

($V_{EBO} = 0.5\text{ V}$; $f = 1\text{ MHz}$)

	BCX 58	BCX 59	
V_{CEsat}	<0.5	<0.5	V
V_{BEsat}	<1	<1	V
C_{CBO}	<4.5	<4.5	pF
C_{EBO}	<15	<15	pF

Collector cutoff current

($V_{CE} = 32\text{ V}$)

($V_{CE} = 32\text{ V}$; $T_{amb} = 125\text{ }^{\circ}\text{C}$)

($V_{CE} = 32\text{ V}$; $T_{amb} = 100\text{ }^{\circ}\text{C}$;

$V_{BE} = 0.2\text{ V}$)

Collector cutoff current

($V_{CE} = 45\text{ V}$)

($V_{CE} = 45\text{ V}$; $T_{amb} = 125\text{ }^{\circ}\text{C}$)

($V_{CE} = 45\text{ V}$; $T_{amb} = 100\text{ }^{\circ}\text{C}$;

$V_{BE} = 0.2\text{ V}$)

Emitter cutoff current

($V_{EBO} = 5\text{ V}$)

Collector-emitter breakdown voltage

($I_C = 10\text{ mA}$)

Emitter-base breakdown voltage

($I_{EBO} = 1\text{ }\mu\text{A}$)

I_{CES}	0.2 (<10)	—	nA
I_{CES}	0.05 (<2.5)	—	μA
I_{CEX}	<20	—	μA
I_{CES}	—	0.2 (<10)	nA
I_{CES}	—	0.05 (<2.5)	μA
I_{CEX}	—	<20	μA
I_{EBO}	<20	<20	nA
$V_{(BR)CEO}$	>32	>45	V
$V_{(BR)EBO}$	>7	>7	V

Dynamic characteristics ($T_{amb} = 25^{\circ}\text{C}$)

Transition frequency
($I_C = 10\text{ mA}$; $V_{CE} = 5\text{ V}$;
 $f = 100\text{ MHz}$)

Collector-base capacitance
($V_{CB} = 10\text{ V}$; $f = 1\text{ MHz}$)

Emitter-base capacitance
($V_{EB} = 0.5\text{ V}$; $f = 1\text{ MHz}$)

Noise figure

($I_C = 0.2\text{ mA}$; $V_{CE} = 5\text{ V}$;
 $R_g = 2\text{ k}\Omega$; $f = 1\text{ kHz}$)

Four-pole characteristics ($I_C = 2\text{ mA}$; $V_{CE} = 5\text{ V}$; $f = 1\text{ kHz}$)

	BCX 58		BCX 59		
f_T	250 (> 125)	250 (> 125)	250 (> 125)	250 (> 125)	MHz
C_{CBO}	< 4.5	< 4.5	< 4.5	< 4.5	pF
C_{EBO}	< 15	< 15	< 15	< 15	pF
NF	2 (< 6)	2 (< 6)	2 (< 6)	2 (< 6)	dB

h_{FE} group	VII	VIII	IX	X	
h_{11e}	2.7 (1.6 to 4.5)	3.6 (2.5 to 6)	5.4 (3.2 to 8.5)	7.5 (4.5 to 12)	k Ω
h_{12e}	1.5	2	2	3	10 ⁻⁴
h_{21e}	200	260	330	520	-
h_{22e}	18 (< 30)	24 (< 50)	30 (< 60)	50 (< 100)	μS

Switching times:

Operating point: $I_C : I_{B1} : -I_{B2} : 10 : 1 : 1\text{ mA}$; $R_1 = 5\text{ k}\Omega$; $R_2 = 5\text{ k}\Omega$; $V_{BB} = 3.6\text{ V}$; $R_L = 999\ \Omega$

t_d	35	ns	t_s	400	ns
t_r	50	ns	t_f	80	ns
t_{on}	85 (< 150)	ns	t_{off}	480 (< 800)	ns

Switching times:

$I_C : I_{B1} : -I_{B2} : 100 : 10 : 10\text{ mA}$; $R_1 = 500\ \Omega$; $R_2 = 700\ \Omega$; $V_{BB} = 5\text{ V}$; $R_L = 98\ \Omega$

t_d	5	ns	t_s	250	ns
t_r	50	ns	t_f	200	ns
t_{on}	55 (< 150)	ns	t_{off}	450 (< 800)	ns

Test circuit for switching time

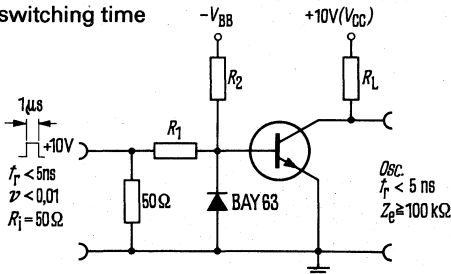

Total perm. power dissipation versus temperature
 $P_{tot} = f(T)$

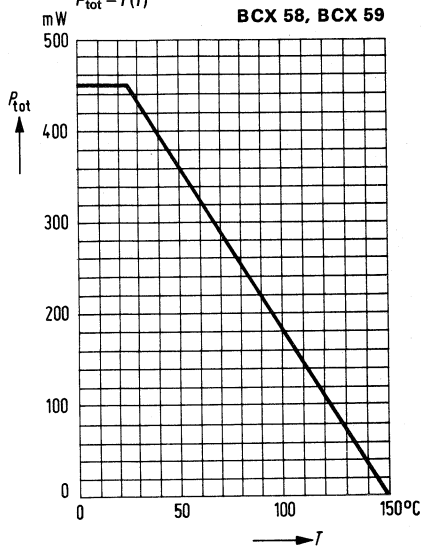

Permissible pulse load
 $r_{thJC} = f(t); v = \text{parameter}$

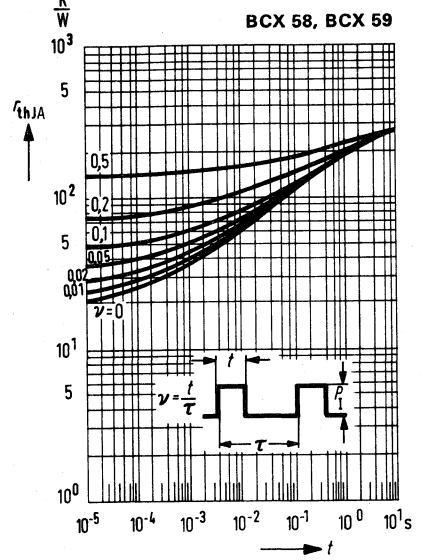

DC current gain $h_{FE} = f(I_C)$
 $V_{CE} = 1\text{V}; T_{amb} = \text{parameter}$
(common emitter configuration)
BCX 58 VIII, BCX 59 VIII

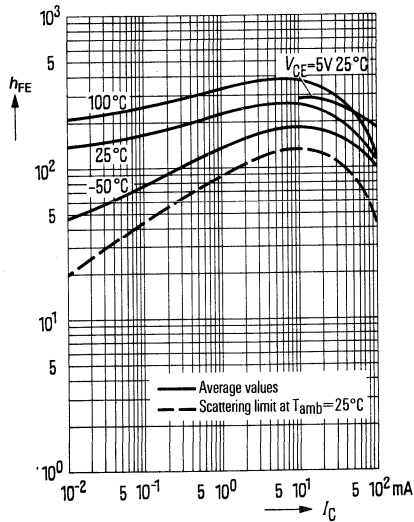

Collector current $I_C = f(V_{BE})$
 $V_{CE} = 1\text{V}$
(common emitter configuration)

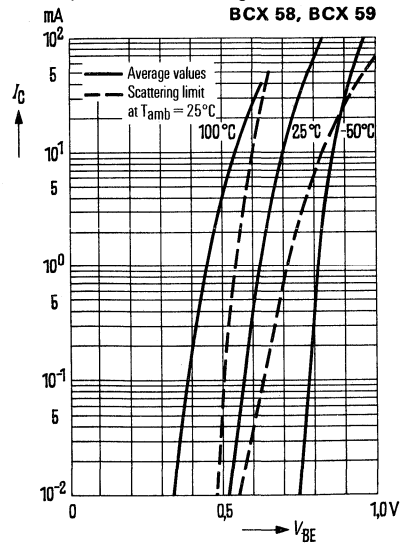

Output characteristics $I_C = f(V_{CE})$
 $I_B = \text{parameter}$
(common emitter configuration)

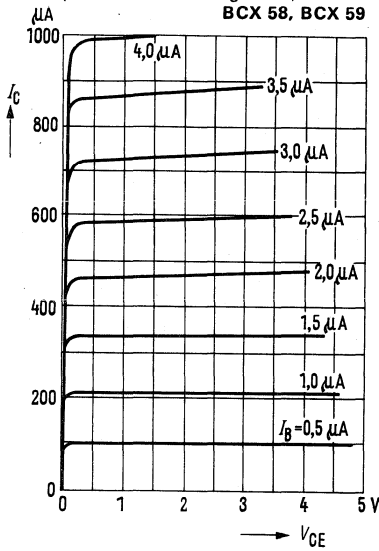

Output characteristics $I_C = f(V_{CE})$
 $V_{BE} = \text{parameter}$
(common emitter configuration)

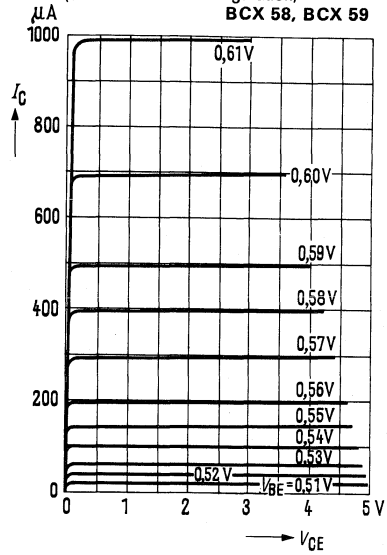

Input characteristics $I_B = f(V_{BE})$
 $V_{CE} = 5 \text{ V}$
(common emitter configuration)

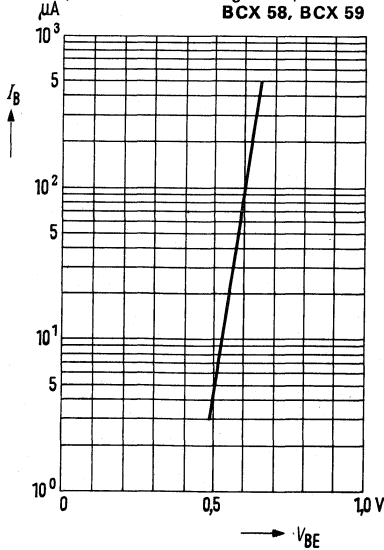

Collector cutoff current versus temperature $I_{CBO} = f(T_{\text{amb}})$ for max. permissible reverse voltage

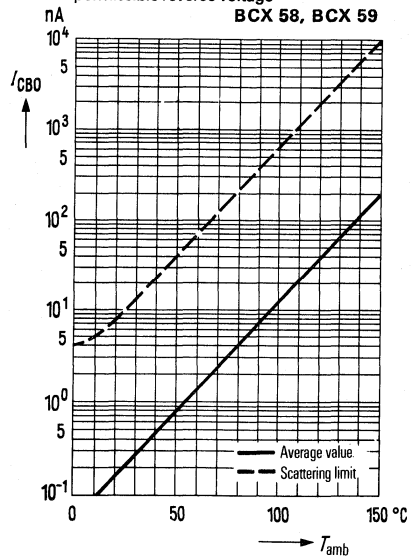

Collector emitter saturation voltage

$V_{CEsat} = f(I_C); h_{FE} = 40$

$T_{amb} = \text{parameter}$

(common emitter configuration)

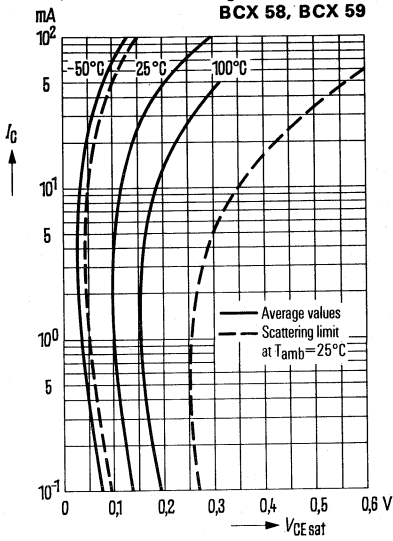

Base-emitter saturation voltage

$V_{BEsat} = f(I_C); T_{amb} = \text{parameter};$

$h_{FE} = 40$

(common emitter configuration)

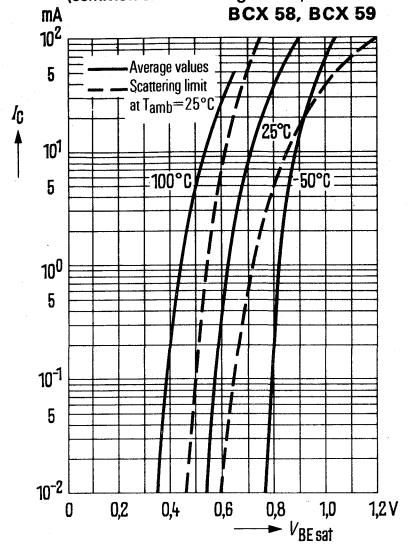

Collector-base capacitance

$C_{CBO} = f(V_{CBO})$

Emitter-base capacitance

$C_{EBO} = f(V_{EBO})$

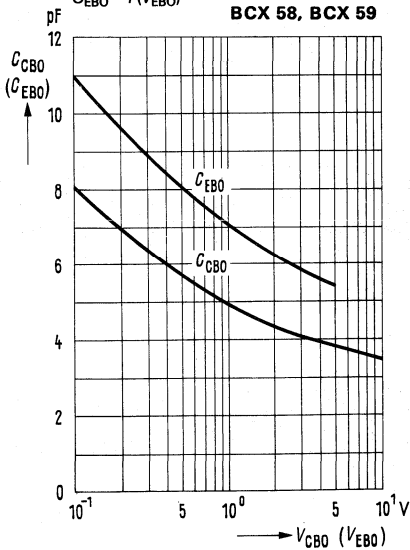

Transition frequency $f_T = f(I_C)$;

$V_{CE} = \text{parameter}$

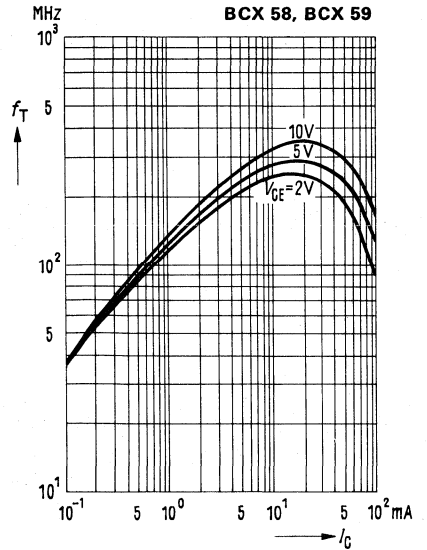

BCX 68 is an epitaxial NPN silicon planar transistor in SOT 89 plastic package. It is the complementary type to BCX 69, and is designed for universal applications of low and medium performance. The transistor is marked by the following code letters:

Type	Mark	Ordering code
BCX 68	CA	Q62702-C958
BCX 68-10	CB	Q62702-C1077
BCX 68-16	CC	Q62702-C1078
BCX 68-25	CD	Q62702-C1079

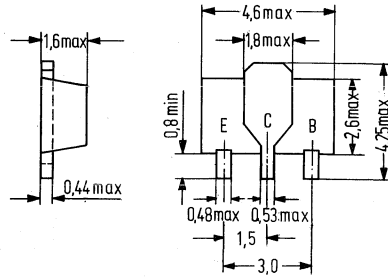

Approx. weight 0.1 g

Dimensions in mm

Maximum ratings ($T_{amb} = 25^{\circ}\text{C}$)

Collector-emitter voltage	V_{CES}	25	V
Collector-emitter voltage	V_{CEO}	20	V
Emitter-base voltage	V_{EBO}	5	V
Collector current	I_C	1	A
Collector peak current	I_{CM}	2	A
Base current	I_B	100	mA
Base peak current	I_{BM}	200	mA
Junction temperature	T_j	150	$^{\circ}\text{C}$
Storage temperature range	T_{stg}	-65 to +150	$^{\circ}\text{C}$
Total power dissipation ($T_{SB} = 60^{\circ}\text{C}$) (ceramic substrate 0.7 mm with 2.5 cm ² area)	P_{tot}	3	W

Thermal resistance

Junction to substrate back (ceramic substrate 0.7 mm with 2.5 cm ² area)	R_{thJSB}	< 30	K/W
--	-------------	------	-----

Static characteristics ($T_{\text{amb}} = 25^{\circ}\text{C}$)

Collector-emitter saturation voltage

($I_C = 1\text{ A}$; $I_B = 100\text{ mA}$)

V_{CEsat}	0.5	V
--------------------	-----	---

Collector cutoff current

($V_{\text{CB}} = 25\text{ V}$)

I_{CBO}	< 100	nA
------------------	-------	----

($V_{\text{CB}} = 25\text{ V}$; $T_j = 150^{\circ}\text{C}$)

I_{CBO}	< 10	μA
------------------	------	---------------

Emitter cutoff current ($V_{\text{EB}} = 5\text{ V}$)

I_{EBO}	< 10	μA
------------------	------	---------------

Base-emitter voltage

($V_{\text{CE}} = 10\text{ V}$; $I_C = 5\text{ mA}$)

V_{BE}	0.6	V
-----------------	-----	---

($V_{\text{CE}} = 1\text{ V}$; $I_C = 1\text{ A}$)

V_{BE}	< 1	V
-----------------	-----	---

DC current gain

 $V_{\text{CE}} = 10\text{ V}$; $I_C = 5\text{ mA}$

h_{FE}	> 50	—
-----------------	------	---

 $V_{\text{CE}} = 1\text{ V}$; $I_C = 0.5\text{ A}$

h_{FE}	85 to 375 ¹⁾	—
-----------------	-------------------------	---

 $V_{\text{CE}} = 1\text{ V}$; $I_C = 1\text{ A}$

h_{FE}	> 60	—
-----------------	------	---

Dynamic characteristics ($T_{\text{amb}} = 25^{\circ}\text{C}$)

Transition frequency

($V_{\text{CE}} = 5\text{ V}$; $I_C = 10\text{ mA}$; $f = 20\text{ MHz}$)

f_T	65	MHz
-------	----	-----

1) divided into the groups: 10 ($h_{\text{FE}} = 63$ to 160)
 16 ($h_{\text{FE}} = 100$ to 250)
 25 ($h_{\text{FE}} = 160$ to 400)

Total perm. power dissipation versus temperature
 $P_{tot} = f(T_{SB})$

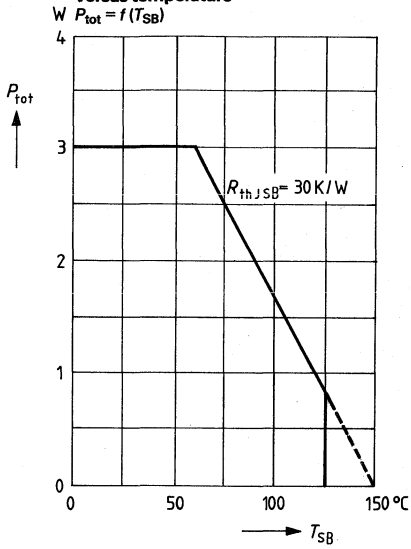

Permissible pulse load
 $r_{thJSB} = f(t) \text{ v = parameter}$

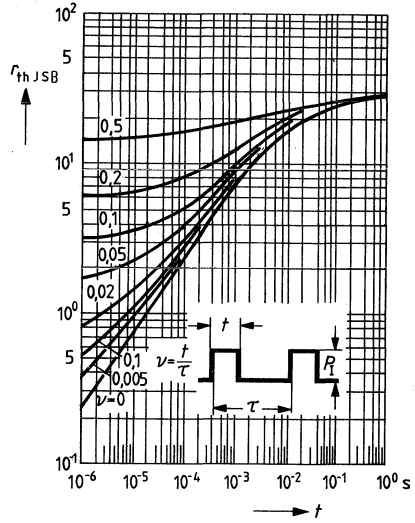

Collector cutoff current versus temperature
 $I_{CB0} = f(T_{amb})$
 $V_{CB} = V_{CBmax}$

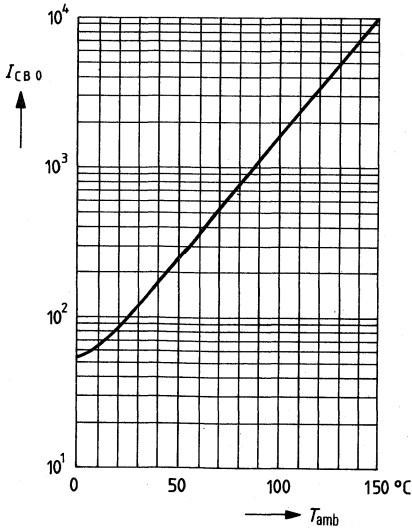

DC current gain $h_{FE} = f(I_C)$
 $V_{CE} = 1 \text{ V}; T_{amb} = 25^\circ \text{C}$

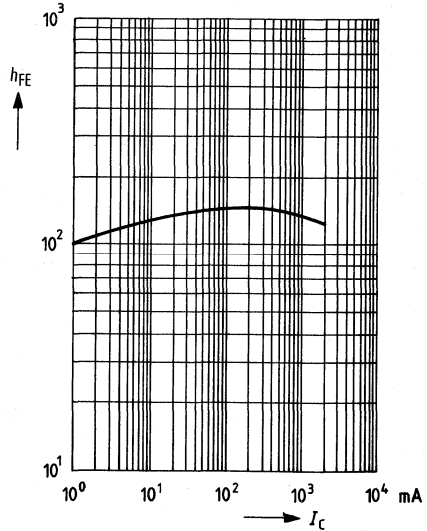

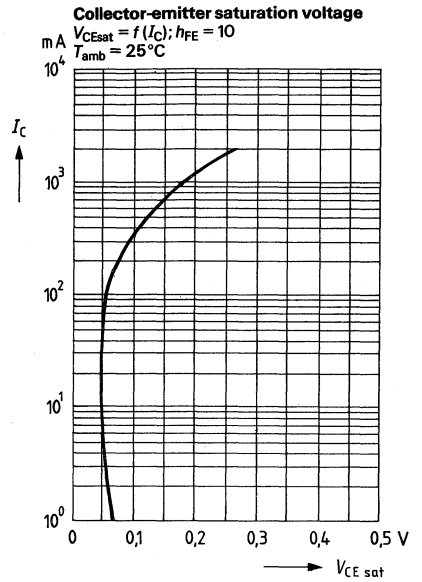
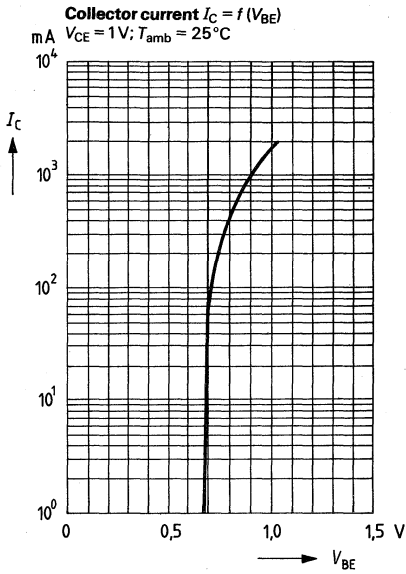

BCX 69 is an epitaxial PNP silicon planar transistor in SOT 89 plastic package. It is the complementary type to BCX 68, and is designed for universal applications of low and medium performance. The transistor is marked by the following code letters:

Type	Mark	Ordering code
BCX 69	CE	Q62702-C957
BCX 69-10	CF	Q62702-C1080
BCX 69-16	CG	Q62702-C1081
BCX 69-25	CH	Q62702-C1082

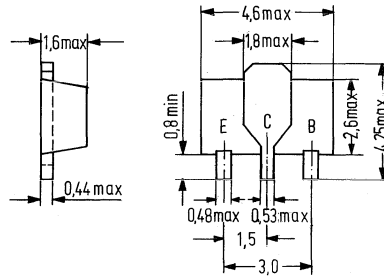

Approx. weight 0.1 g

Dimensions in mm

Maximum ratings ($T_{amb} = 25^{\circ}\text{C}$)

Collector-emitter voltage	$-V_{CES}$	25	V
Collector-emitter voltage	$-V_{CEO}$	20	V
Emitter-base voltage	$-V_{EBO}$	5	V
Collector current	$-I_C$	1	A
Collector peak current	$-I_{CM}$	2	A
Base current	$-I_B$	100	mA
Base peak current	$-I_{BM}$	200	mA
Junction temperature	T_j	150	$^{\circ}\text{C}$
Storage temperature range	T_{stg}	-65 to +150	$^{\circ}\text{C}$
Total power dissipation ($T_{SB} = 60^{\circ}\text{C}$) (ceramic substrate 0.7 mm with 2.5 cm ² area)	P_{tot}	3	W

Thermal resistance

Junction to substrate back (ceramic substrate 0.7 mm with 2.5 cm ² area)	R_{thJSB}	< 30	K/W
--	-------------	------	-----

Static characteristics ($T_{amb} = 25^{\circ}\text{C}$)

Collector-emitter saturation voltage

($-I_C = 1\text{ A}$; $-I_B = 100\text{ mA}$)

$-V_{CEsat}$	< 0.5	V
--------------	-------	---

Collector cutoff current

($-V_{CB} = 25\text{ V}$)

$-I_{CBO}$	< 100	nA
------------	-------	----

($-V_{CB} = 25\text{ V}$; $T_j = 150^{\circ}\text{C}$)

$-I_{CBO}$	< 10	μA
------------	------	---------------

Emitter cutoff current

($-V_{EB} = 5\text{ V}$)

$-I_{EBO}$	< 10	μA
------------	------	---------------

Base-emitter voltage

($-V_{CE} = 10\text{ V}$, $-I_C = 5\text{ mA}$)

$-V_{BE}$	0.6	V
-----------	-----	---

($-V_{CE} = 1\text{ V}$, $-I_C = 1\text{ A}$)

$-V_{BE}$	< 1	V
-----------	-----	---

DC current gain

$-V_{CE} = 10\text{ V}$, $-I_C = 5\text{ mA}$

h_{FE}	> 50	-
----------	------	---

$-V_{CE} = 1\text{ V}$, $-I_C = 0.5\text{ A}$

h_{FE}	85 to 375 ¹⁾	-
----------	-------------------------	---

$-V_{CE} = 1\text{ V}$, $-I_C = 1\text{ A}$

h_{FE}	> 60	-
----------	------	---

Dynamic characteristics ($T_{amb} = 25^{\circ}\text{C}$)

Transition frequency

($-V_{CE} = 5\text{ V}$, $-I_C = 10\text{ mA}$; $f = 20\text{ MHz}$)

f_T	65	MHz
-------	----	-----

1) divided into the groups: 10 ($h_{FE} = 63$ to 160)
 16 ($h_{FE} = 100$ to 250)
 25 ($h_{FE} = 160$ to 400)

Total perm. power dissipation versus temperature
 $P_{tot} = f(T_{SB})$

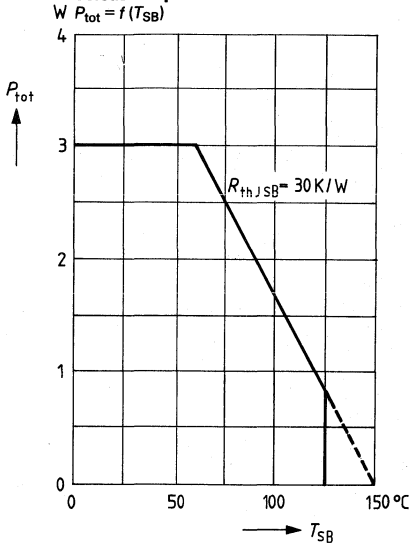

Permissible pulse load
 $r_{thJSB} = f(t)$ v = parameter

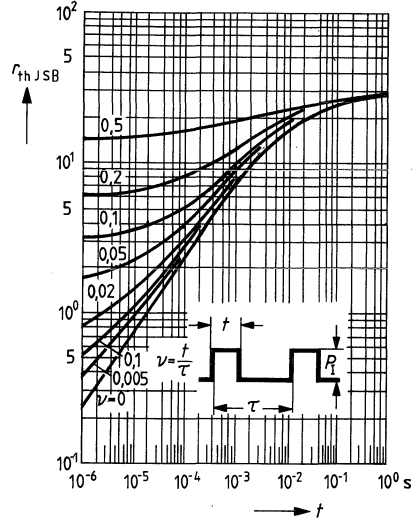

Collector cutoff current versus temperature
 $I_{CB0} = f(T_{amb})$

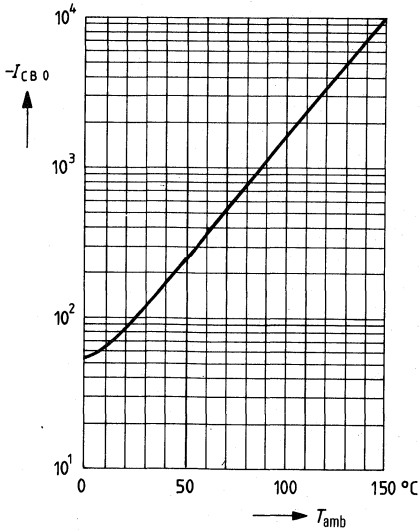

DC current gain $h_{FE} = f(I_C)$
 $V_{CE} = 1 \text{ V}; T_{amb} = 25^\circ \text{C}$

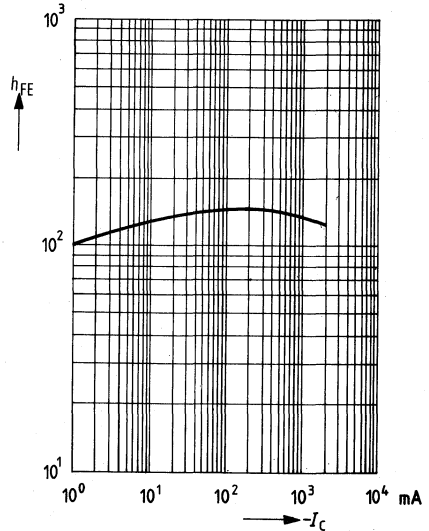

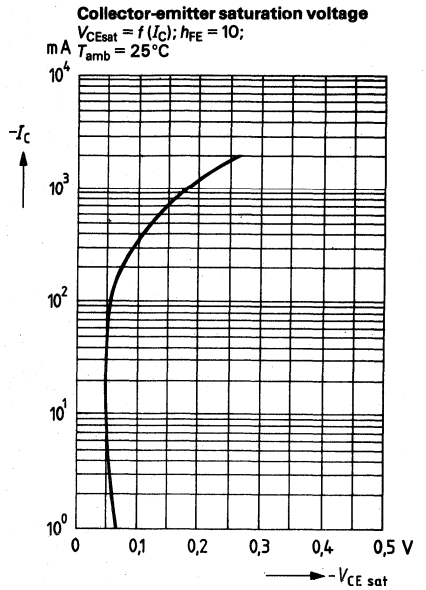
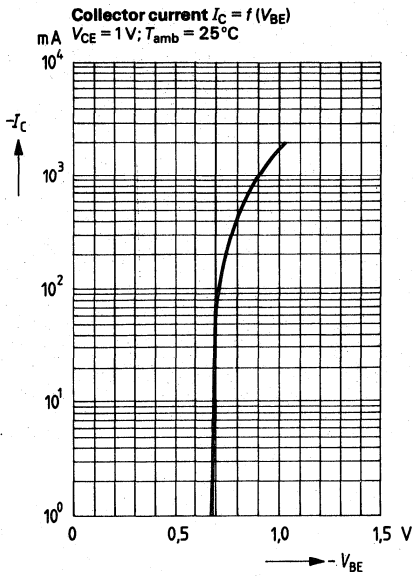

BCX 73 and BCX 74 are epitaxial NPN silicon planar transistors in 10 A 3 DIN 41868 plastic package (similar to TO 92). The transistors are designed for use in driver and output stages as well as for switching applications. Complementary transistors are BCX 75 and BCX 76.

Type	Ordering code
BCX 73	Q62702-C634
BCX 73-16	Q62702-C634-S1
BCX 73-25	Q62702-C634-S2
BCX 73-40	Q62702-C634-S3
BCX 74	Q62702-C635
BCX 74-16	Q62702-C635-S1
BCX 74-25	Q62702-C635-S2
BCX 74-40	Q62702-C635-S3

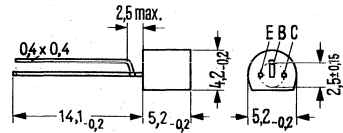

Mounting instruction: Fixing hole dia 0.6
Approx. weight 0.25 g Dimensions in mm

Maximum ratings

		BCX 73	BCX 74	
Collector-emitter voltage	V_{CEO}	32	45	V
Collector-emitter voltage	V_{CES}	60	75	V
Emitter-base voltage	V_{EBO}	5	5	V
Collector current	I_C	800	800	mA
Collector peak current	I_{CM}	1000	1000	mA
Base current	I_B	100	100	mA
Junction temperature	T_j	150	150	°C
Storage temperature range	T_{stg}	-55 to +150	-55 to +150	°C
Total power dissipation ($T_{amb} > 25^\circ\text{C}$)	P_{tot}	625	625	mW

Thermal resistance

		BCX 73	BCX 74	
Junction to ambient air	R_{thJA}	≤ 200	≤ 200	K/W
Junction to case	R_{thJC}	≤ 90	≤ 90	K/W

Static characteristics ($T_{amb} = 25^\circ\text{C}$)

Collector cutoff current				
($V_{CES} = 32\text{ V}$)	I_{CES}	< 20	-	nA
($V_{CES} = 32\text{ V}; T_j = 125^\circ\text{C}$)	I_{CES}	< 2	-	μA
Collector cutoff current				
($V_{CES} = 45\text{ V}$)	I_{CES}	-	< 20	nA
($V_{CES} = 45\text{ V}; T_j = 125^\circ\text{C}$)	I_{CES}	-	< 2	μA
Emitter cutoff current				
($V_{EBO} = 4\text{ V}$)	I_{EBO}	< 20	< 20	nA

	BCX 73	BCX 74		
Collector-emitter breakdown voltage ($I_C = 10 \mu\text{A}$)	$V_{(BR)CES}$	> 60	> 75	V
Collector-emitter breakdown voltage ($I_C = 10 \text{mA}$)	$V_{(BR)CEO}$	> 32	> 45	V
Emitter-base breakdown voltage ($I_{EBO} = 10 \mu\text{A}$)	$V_{(BR)EBO}$	> 5	> 5	V

The following values apply to the collector currents indicated below:

V_{CE} V	I_C mA	h_{FE} I_C/I_B	V_{CEsat} V	V_{BEsat} V
10	0.1	> 35		
1	1	> 50		
1	10	> 75		
1	100	100 to 630 ¹⁾	< 0.25 ²⁾	
2	500	> 35	< 0.6 ³⁾	< 1.5 ³⁾

Base-emitter forward voltage ($I_C = 500 \text{mA}$; $V_{CE} = 2 \text{V}$)	V_{BE}	< 1.4	V
Collector-base capacitance ($V_{CBO} = 10 \text{V}$)	C_{CBO}	8 (< 12)	pF
Emitter-base capacitance ($V_{EBO} = 0.5 \text{V}$)	C_{EBO}	< 80	pF

Dynamic characteristics ($T_{amb} = 25^\circ\text{C}$):

Transition frequency ($I_C = 20 \text{mA}$; $V_{CE} = 10 \text{V}$; $f = 100 \text{MHz}$)	f_T	> 100	MHz
Noise figure ($I_C = 0.2 \text{mA}$; $V_{CE} = 5 \text{V}$; $R_g = 1 \text{k}\Omega$; $f = 1 \text{kHz}$)	NF	2 (< 10)	dB
Switching times ($I_C = 150 \text{mA}$; $R_L = 150 \Omega$; I_B approx. $-I_{B2} = 15 \text{mA}$)	t_{on}	< 100	ns
	t_{off}	< 400	ns

1) divided into the groups: 16 ($h_{FE} = 100-250$)
25 ($h_{FE} = 160-400$)
40 ($h_{FE} = 250-630$)

2) $I_B = 10 \text{mA}$
3) $I_B = 50 \text{mA}$

Total perm. power dissipation versus temperature
 $P_{tot} = f(T_{amb})$

BCX 73, BCX 74

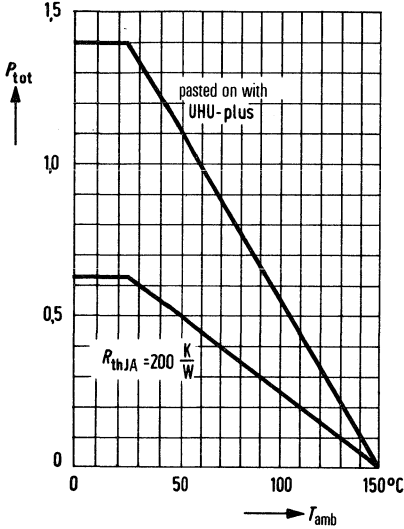

Permissible pulse load

$r_{thJA} = f(t) \nu = \text{parameter}$

BCX 73, BCX 74

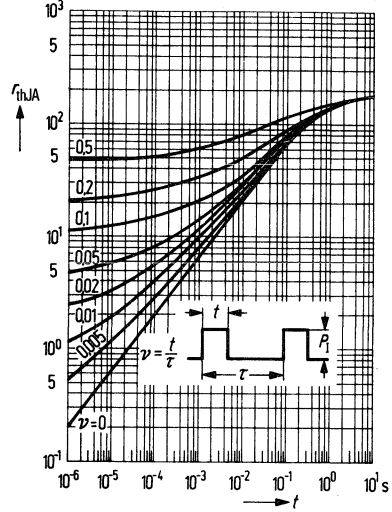

Collector cutoff current versus temperature
 $I_{CES} = f(T_{amb})$

$V_{CES} = 32 \text{ or } 45 \text{ V}$

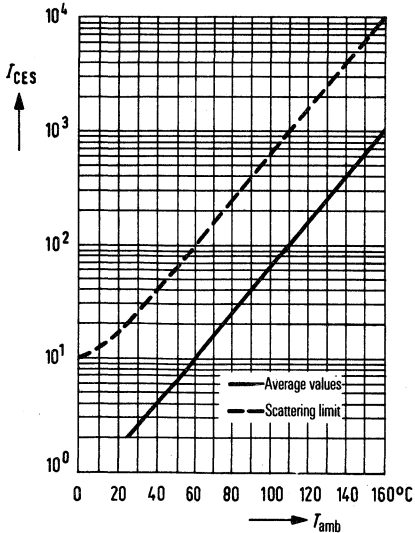

DC current gain $h_{FE} = f(I_C)$

$V_{CE} = 1 \text{ V}; T_{amb} = \text{parameter}$

h_{FE} group 25

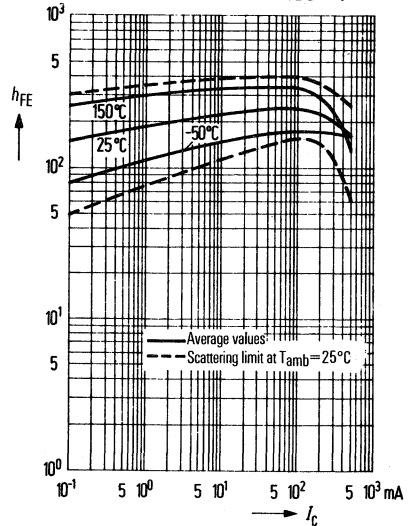

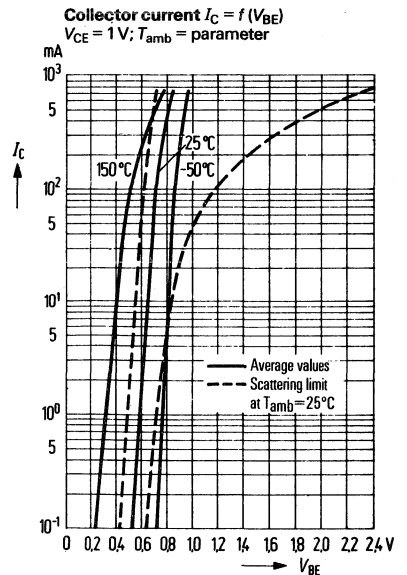
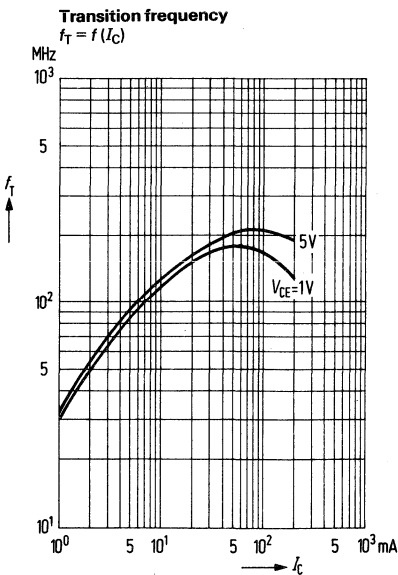
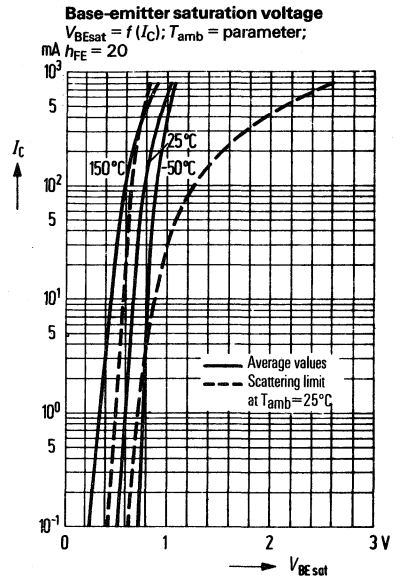
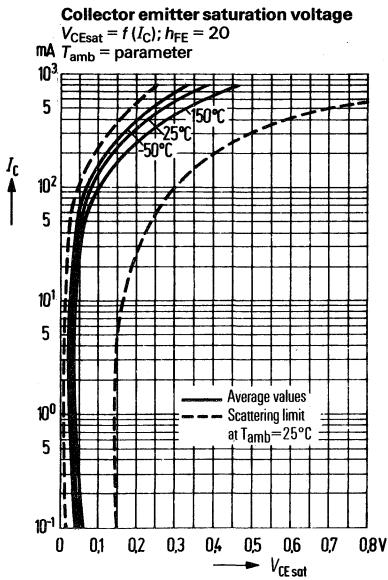

BCX 75 and BCX 76 are epitaxial PNP silicon planar transistors in 10 A 3 DIN 41868 plastic package (similar to TO 92). The transistors are designed for use in AF input and driver stages as well as for switching applications. Complementary transistors are BCX 73 and BCX 74.

Type	Ordering code
BCX 75	Q62702-C636
BCX 75-16	Q62702-C636-S1
BCX 75-25	Q62702-C636-S2
BCX 75-40	Q62702-C636-S3
BCX 76	Q62702-C637
BCX 76-16	Q62702-C637-S1
BCX 76-25	Q62702-C637-S2
BCX 76-40	Q62702-C637-S3

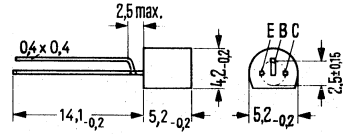

Approx. weight 0.25 g Dimensions in mm
Mounting instruction:
Fixing hole dia 0.6

Maximum ratings

	BCX 75	BCX 76		
Collector-emitter voltage	-V _{CEO}	32	45	V
Collector-emitter voltage	-V _{CES}	60	75	V
Emitter-base voltage	-V _{EBO}	5	5	V
Collector current	-I _C	800	800	mA
Collector peak current	-I _{CM}	1000	1000	mA
Base current	-I _B	100	100	mA
Junction temperature	T _j	150	150	°C
Storage temperature range	T _{stg}	-55 to +150		°C
Total power dissipation (T _{amb} < 25 °C)	P _{tot}	625	625	mW

Thermal resistance

Junction to ambient air	R _{thJA}	≤ 200	≤ 200	K/W
Junction to case	R _{thJC}	≤ 90	≤ 90	K/W

Static characteristics (T_{amb} = 25 °C)

Collector cutoff current				
(-V _{CE} = 32 V)	-I _{CES}	< 20	-	nA
(-V _{CE} = 32 V; T _{amb} = 125 °C)	-I _{CES}	< 2	-	μA
Collector cutoff current				
(-V _{CE} = 45 V)	-I _{CES}	-	< 20	nA
(-V _{CE} = 45 V; T _{amb} = 125 °C)	-I _{CES}	-	< 2	μA
Emitter cutoff current				
(-V _{BEO} = 4 V)	-I _{EBO}	< 20	< 20	nA

	BCX 75	BCX 76	
Collector-emitter breakdown voltage ($-I_C = 10 \mu\text{A}$)	$-V_{(BR)CES} > 60$	> 75	V
Collector-emitter breakdown voltage ($-I_C = 10 \text{mA}$)	$-V_{(BR)CEO} > 32$	> 45	V
Emitter-base breakdown voltage ($-I_{EBO} = 10 \mu\text{A}$)	$-V_{(BR)EBO} > 5$	> 5	V

The following values apply to the collector currents indicated below:

$-V_{CE}$ V	$-I_C$ mA	h_{FE} I_C/I_B	$-V_{CEsat}$ V	$-V_{BEsat}$ V
10	0.1	> 35	-	-
1	1	> 50	-	-
1	10	> 75	-	-
1	100	100 to 630 ¹⁾	$< 0.25^2)$	-
2	500	> 35	< 0.6	$< 1.5^3)$

Base-emitter forward voltage ($-I_C = 500 \text{mA}$; $-V_{CE} = 2 \text{V}$)	$-V_{BE}$	< 1.4	V
Collector-base capacitance ($-V_{CBO} = 10 \text{V}$)	C_{CBO}	12 (< 18)	pF
Emitter-base capacitance ($-V_{EBO} = 0.5 \text{V}$)	C_{EBO}	< 80	pF

Dynamic characteristics ($T_{amb} = 25^\circ\text{C}$)

Transition frequency ($-I_C = 20 \text{mA}$; $-V_{CE} = 10 \text{V}$; $f = 100 \text{MHz}$)	f_T	> 100	MHz
Noise figure ($-I_C = 0.2 \text{mA}$; $-V_{CE} = 5 \text{V}$; $R_g = 1 \text{k}\Omega$; $f = 1 \text{kHz}$)	NF	2 (< 10)	dB
Switching times ($-I_C = 150 \text{mA}$; $R_L = 150 \Omega$; $I_{B1} - I_{B2} = 15 \text{mA}$)	t_{on} t_{off}	< 100 < 400	ns ns

1) divided into the groups: 16 ($h_{FE} = 100-250$)
25 ($h_{FE} = 160-400$)
40 ($h_{FE} = 250-630$)

2) $I_B = 10 \text{mA}$
3) $I_B = 50 \text{mA}$

Total perm. power dissipation versus temperature
 $P_{tot} = f(T_{amb})$

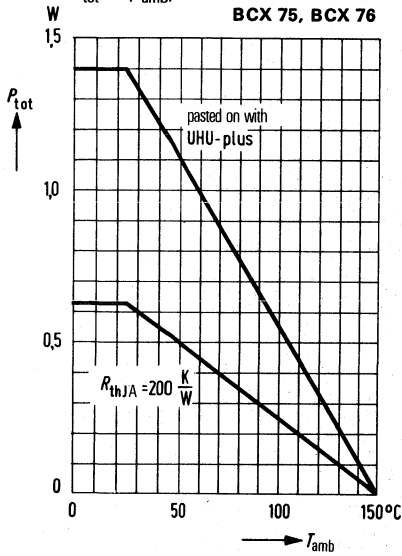

Permissible pulse load
 $r_{thJA} = f(t); v = \text{parameter}$

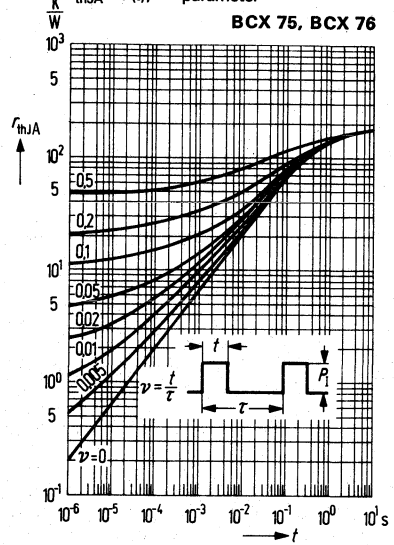

Collector cutoff current versus temperature
 $I_{CES} = f(T_{amb})$
 $V_{CES} = 32 \text{ or } 45 \text{ V}$

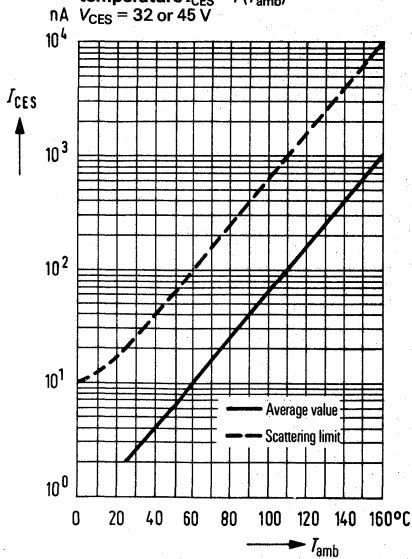

DC current gain $h_{FE} = f(I_C)$
 $V_{CE} = 1 \text{ V}; T_{amb} = \text{parameter}$

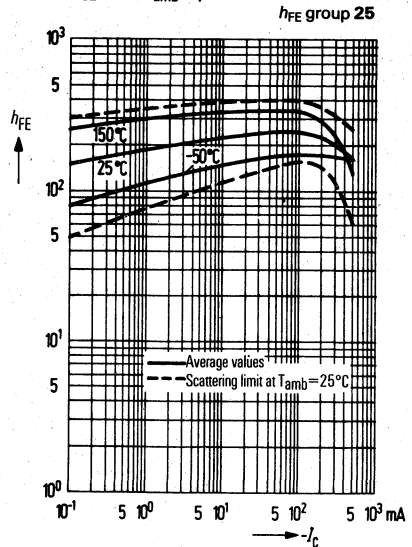

Collector emitter saturation voltage

$V_{CEsat} = f(I_C); h_{FE} = 20$

$T_{amb} = \text{parameter}$

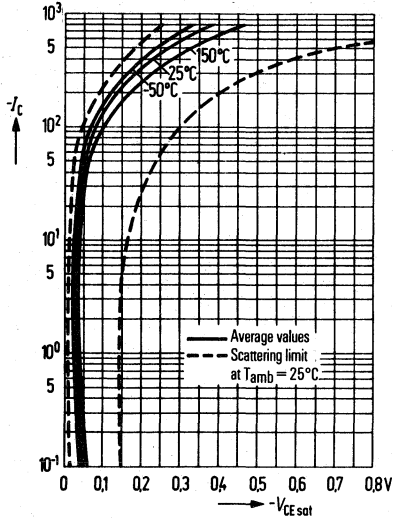

Base-emitter saturation voltage

$V_{BEsat} = f(I_C); T_{amb} = \text{parameter};$

$h_{FE} = 20$

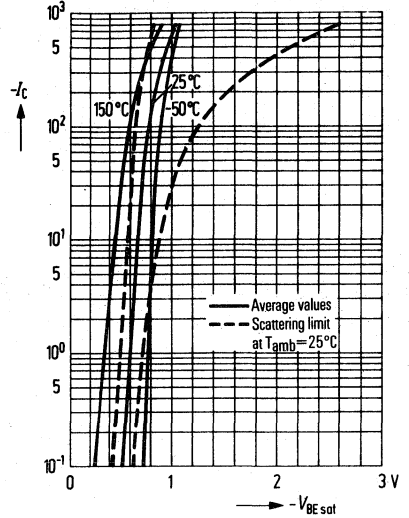

Transition frequency

$f_T = f(I_C)$

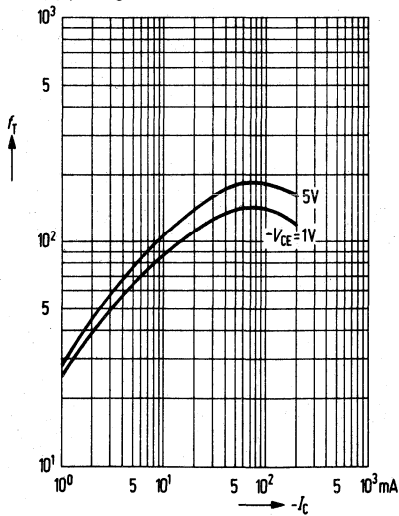

Collector current $I_C = f(V_{BE})$

$V_{CE} = 1V; T_{amb} = \text{parameter}$

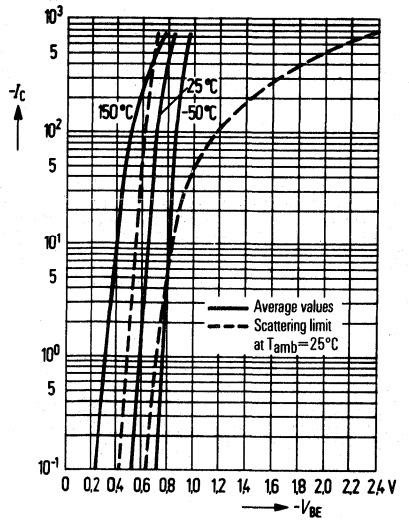

BCX 78 and BCX 79 are epitaxial PNP silicon planar transistors in 10 A 3 DIN 41868 plastic package (similar to TO 92). The transistors are designed for use in AF input and driver stages as well as for switching applications. Complementary transistors are BCX 58 and BCX 59.

Type	Ordering code
BCX 78	Q62702-C717
BCX 78 VII	Q62702-C626
BCX 78 VIII	Q62702-C627
BCX 78 IX	Q62702-C628
BCX 78 X	Q62702-C629
BCX 79	Q62702-C718
BCX 79 VII	Q62702-C630
BCX 79 VIII	Q62702-C631
BCX 79 IX	Q62702-C632
BCX 79 X	Q62702-C633

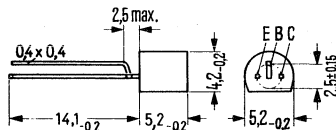

Mounting instruction: Fixing hole dia 0.6
Approx. weight 0.25 g Dimensions in mm

Maximum ratings

	BCX 78	BCX 79		
Collector-emitter voltage	-V _{CEO}	32	45	V
Collector-emitter voltage	-V _{CES}	32	45	V
Emitter-base voltage	-V _{EBO}	5	5	V
Collector current	-I _C	100	100	mA
Collector peak current	-I _{CM}	200	200	mA
Base current	-I _B	50	50	mA
Junction temperature	T _j	150	150	°C
Storage temperature range	T _{stg}	-55 to +150		°C
Total power dissipation (T _{amb} < 25 °C)	P _{tot}	450	450	mW

Thermal resistance

Junction to ambient air	R _{thJA}	< 280	< 280	K/W
-------------------------	-------------------	-------	-------	-----

Static characteristics ($T_{amb} = 25^{\circ}\text{C}$)

Type		BCX 78 BCX 79				BCX 78
		VII	VIII	IX	X	BCX 79
h_{FE} group		h_{FE} I_C/I_B	h_{FE} I_C/I_B	h_{FE} I_C/I_B	h_{FE} I_C/I_B	$-V_{BE}$ (V)
5	0.01	140	200 (> 30)	270 (> 40)	340 (> 100)	0.55
5	2	170 (120 to 220)	250 (180 to 310)	350 (250 to 460)	500 (380 to 630)	0.65 (0.6 to 0.7)
1	10	180 (> 80)	260 (120 to 400)	360 (160 to 630)	500 (240 to 1000)	0.68
1	100	> 40	> 45	> 60	> 60	0.76 (< 0.9)

	BCX 78	BCX 79	
Collector-emitter saturation voltage ($-I_C = 100\text{ mA}$; $-I_B = 2.5\text{ mA}$)	$-V_{CEsat}$ < 0.6	< 0.6	V
($-I_C = 100\text{ mA}$; $-I_B = 2.5\text{ mA}$)	$-V_{BEsat}$ < 1	< 1	V
Collector cutoff current ($-V_{CES} = 32\text{ V}$)	$-I_{CES}$ 0.2 (< 10)	—	nA
($-V_{CES} = 32\text{ V}$; $T_{amb} = 125^{\circ}\text{C}$)	$-I_{CES}$ 0.05 (< 2.5)	—	μA
($-V_{CE} = 32\text{ V}$; $T_{amb} = 100^{\circ}\text{C}$; $V_{BE} = 0.2\text{ V}$)	$-I_{CEX}$ < 20	—	μA
Collector cutoff current ($-V_{CES} = 45\text{ V}$)	$-I_{CES}$ —	0.2 (< 10)	nA
($-V_{CES} = 45\text{ V}$; $T_{amb} = 125^{\circ}\text{C}$)	$-I_{CES}$ —	0.05 (< 2.5)	μA
($-V_{CE} = 45\text{ V}$; $T_{amb} = 100^{\circ}\text{C}$; $V_{BE} = 0.2\text{ V}$)	$-I_{CEX}$ —	< 20	μA
Emitter cutoff current ($-V_{EBO} = 4\text{ V}$)	$-I_{EBO}$ < 20	< 20	nA
Collector-emitter breakdown voltage ($-I_C = 10\text{ mA}$)	$-V_{(BR)CEO}$ > 32	> 45	V
Emitter-base breakdown voltage ($-I_{EBO} = 1\text{ }\mu\text{A}$)	$-V_{(BR)EBO}$ > 5	> 5	V

Dynamic characteristics ($T_{amb} = 25^{\circ}\text{C}$):

		BCX 78	BCX 79	
Transition frequency ($-I_C = 10\text{ mA}$; $-V_{CE} = 5\text{ V}$; $f = 100\text{ MHz}$)	f_T	200	200	MHz
Collector-base capacitance ($-V_{CBO} = 10\text{ V}$; $f = 1\text{ MHz}$)	C_{CBO}	<4.5	<4.5	pF
Emitter-base capacitance ($-V_{EBO} = 0.5\text{ V}$; $f = 1\text{ MHz}$)	C_{EBO}	<15	<15	pF
Noise figure ($-I_C = 0.2\text{ mA}$; $-V_{CE} = 5\text{ V}$; $R_g = 2\text{ k}\Omega$, $f = 1\text{ kHz}$)	NF	2 (<6)	2 (<6)	dB

Four-pole characteristics ($-I_C = 2\text{ mA}$; $-V_{CE} = 5\text{ V}$; $f = 1\text{ kHz}$)

h_{FE} group	VII	VIII	IX	X	
h_{11e}	2.7 (1.6 to 4.5)	3.6 (2.5 to 6)	4.5 (3.2 to 8.5)	7.5	k Ω
h_{12e}	1.5	2	2	3	10^{-4}
h_{21e}	200	260	330	520	-
h_{22e}	18 (<30)	24 (<50)	30 (<60)	50 (<100)	μS

Switching times:

Operating point: $-I_C: I_{B1} : -I_{B2}$ 10:1:1 mA; $R_1 = 5\text{ k}\Omega$;
 $R_2 = 5\text{ k}\Omega$; $V_{BB} = 3.6\text{ V}$; $R_L = 999\ \Omega$

t_d	35	ns	t_s	400	ns
t_r	50	ns	t_f	80	ns
t_{on}	85 (<150)	ns	t_{off}	480 (<800)	ns

Operating point: $-I_C: I_{B1} : -I_{B2}$; 100:10:10 mA; $R_1 = 500\ \Omega$;
 $R_2 = 700\ \Omega$; $V_{BB} = 5\text{ V}$; $R_L = 98\ \Omega$

t_d	5	ns	t_s	250	ns
t_r	50	ns	t_f	200	ns
t_{on}	55 (<150)	ns	t_{off}	450 (<800)	ns

Test circuit for switching time:

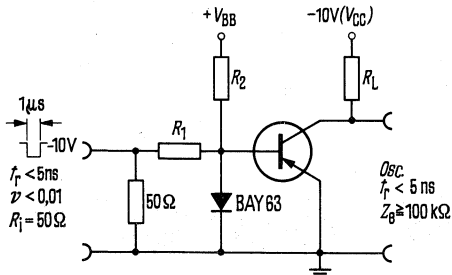

Total perm. power dissipation versus temperature
 $P_{tot} = f(T)$

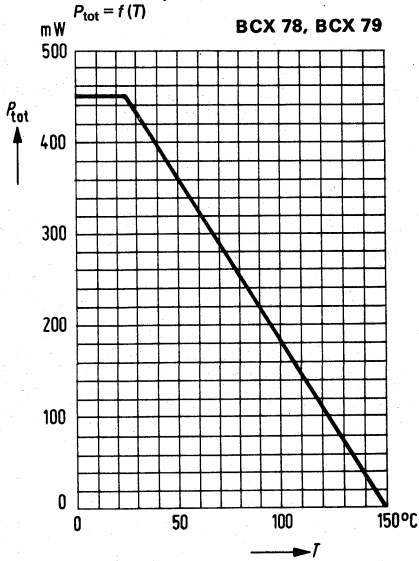

Permissible pulse load
 $r_{thJC} = f(t); v = \text{parameter}$

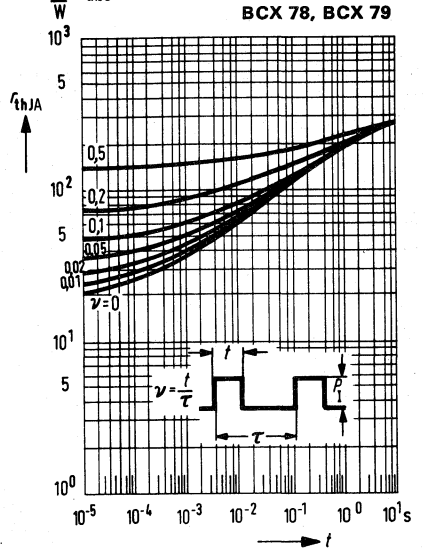

Collector current $I_C = f(V_{BE})$
 $V_{CE} = 1V; T_{amb} = \text{parameter}$

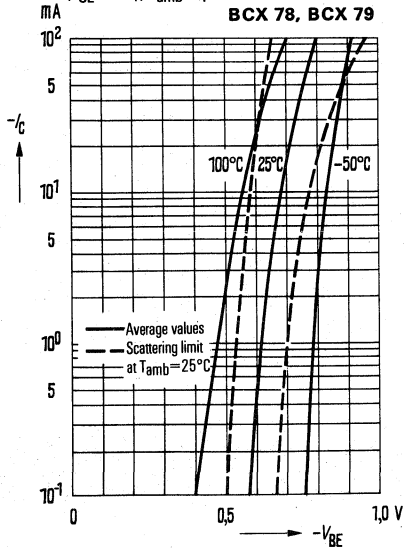

Input characteristic $I_B = f(V_{BE})$
 $V_{CE} = 5V; T_{amb} = 25^\circ C$

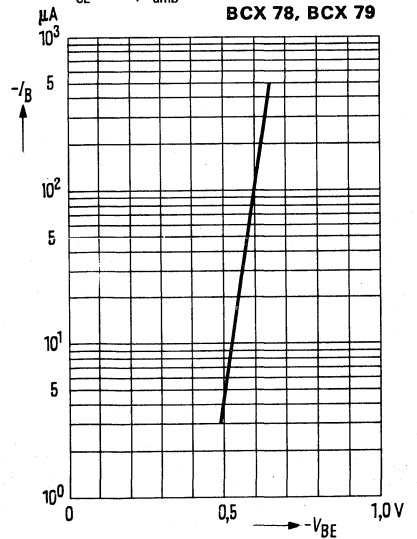

Output characteristics $I_C = f(V_{CE})$
 $I_B = \text{parameter}$

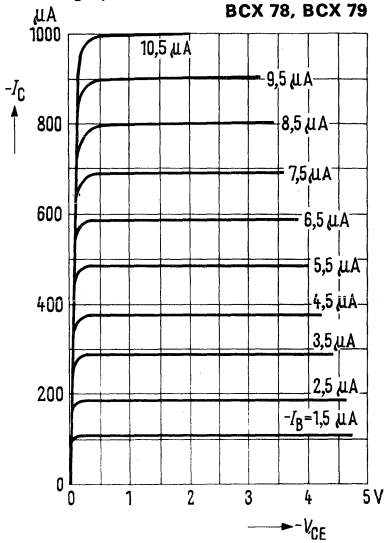

DC current gain $h_{FE} = f(I_C)$
 $V_{CE} = 1\text{ V}; T_{\text{amb}} = \text{parameter}$

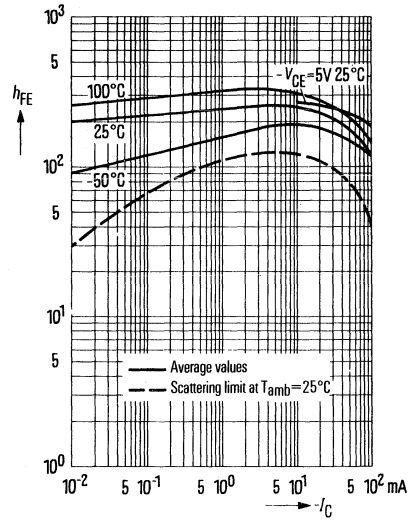

Collector-emitter saturation voltage
 $V_{CEsat} = f(I_C); h_{FE} = 40;$
 $T_{\text{amb}} = \text{parameter}$

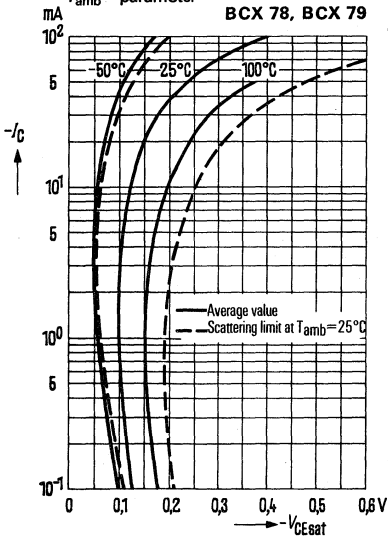

Base-emitter saturation voltage
 $V_{BEsat} = f(I_C); T_{\text{amb}} = \text{parameter};$
 $h_{FE} = 40$

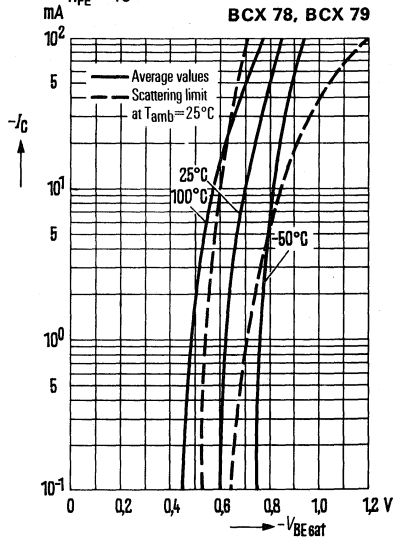

***h*-parameter versus collector current**

$$H_e = \frac{h_e(I_c)}{h_o(I_c = 2 \text{ mA})} = f(I_c)$$

BCX 78, BCX 79

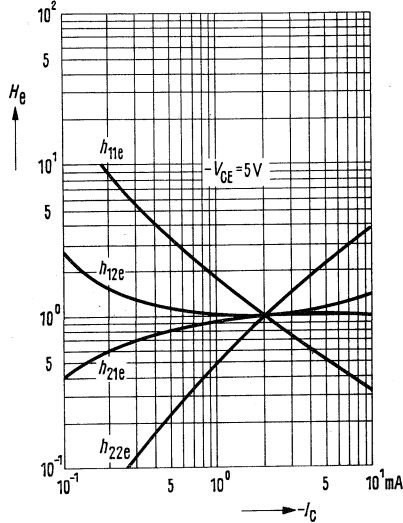

Transition frequency $f_T = f(I_c)$

BCX 78, BCX 79

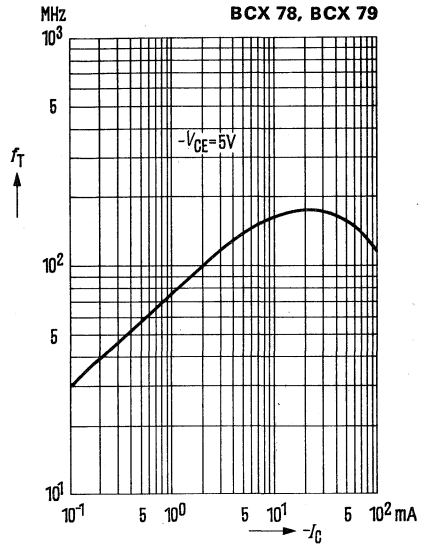

Collector-base capacitance

$$C_{CBO} = f(V_{CBO})$$

Emitter-base capacitance

$$C_{EBO} = f(V_{EBO})$$

$f = 1 \text{ MHz}; T_{amb} = 25^\circ\text{C}$

BCX 78, BCX 79

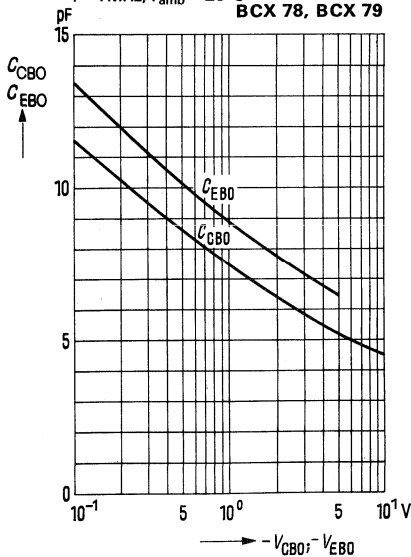

Collector cutoff current versus temperature $I_{CBO} = f(T_{amb})$ for max. permissible reverse voltage

BCX 78, BCX 79

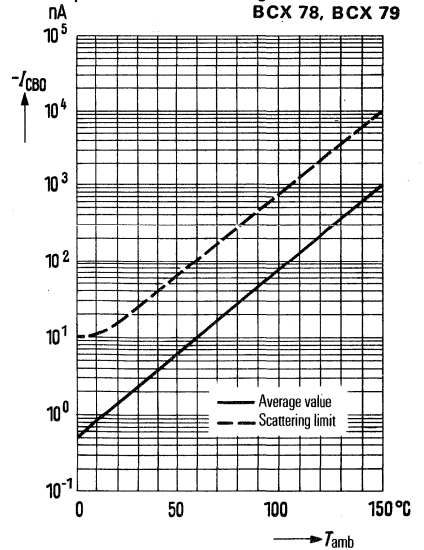

BCY 58, BCY 59, and BCY 65 E are epitaxial NPN silicon planar transistors in TO 18 cases (18 A 3 DIN 41876). The collector is electrically connected to the case. The transistors are particularly suitable for AF input and driver stages as well as for switching applications.

Type	Ordering code
BCY 58	Q60203-Y58
BCY 58 VII	Q60203-Y58-G
BCY 58 VIII	Q60203-Y58-H
BCY 58 IX	Q60203-Y58-J
BCY 58 X	Q60203-Y58-K
BCY 59	Q60203-Y59
BCY 59 VII	Q60203-Y59-G
BCY 59 VIII	Q60203-Y59-H
BCY 59 IX	Q60203-Y59-J
BCY 59 X	Q60203-Y59-K
BCY 65 E	Q60203-Y65-S2
BCY 65 E VII	Q60203-Y65-E7
BCY 65 E VIII	Q60203-Y65-E8
BCY 65 E IX	Q60203-Y65-E9

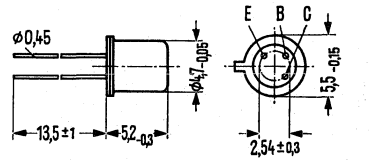

Approx. weight 0.3 g

Dimensions in mm

Maximum ratings

		BCY 58	BCY 59	BCY 65 E	
Collector-emitter voltage	V_{CES}	32	45	60	V
Collector-emitter voltage	V_{CEO}	32	45	60	V
Emitter-base voltage	V_{EBO}	7	7	7	V
Collector current	I_C	200	200	100	mA
Base current	I_B	50	50	50	mA
Junction temperature	T_j	200	200	200	°C
Storage temperature range	T_{stg}	-65 to +200			°C
Total power dissipation ($T_{case} \leq 45^\circ\text{C}$)	P_{tot}	1	1	1	W

Thermal resistance

Junction to ambient air	R_{thJA}	≤ 450	≤ 450	≤ 450	K/W
Junction to case	R_{thJC}	≤ 150	≤ 150	≤ 150	K/W

Static characteristics ($T_{amb} = 25^\circ\text{C}$)

The transistors are grouped according to the DC current gain h_{FE} and marked by Roman numerals.

Static characteristics ($T_{amb} = 25^{\circ}\text{C}$)

Type		BCY 65 E	BCY 65 E	BCY 65 E	-	BCY 58
		BCY 58/59	BCY 58/59	BCY 58/59	BCY 58/59	BCY 59
h_{FE} group		VII	VIII	IX	X	BCY 65E
V_{CE} V	I_C mA	h_{FE} I_C/I_B	h_{FE} I_C/I_B	h_{FE} I_C/I_B	h_{FE} I_C/I_B	V_{BE} V
5	0.01	78	145 (>20)	220 (>40)	300 (>100)	0.5
5	2	170 (120 to 220)	250 (180 to 310)	350 (250 to 460)	500 (380 to 630)	0.62 (0.55 to 0.7)*
1	10	190 (>80)	260 (120 to 400)	380 (160 to 630)	550 (240 to 1000)	0.7
1	50 ¹⁾	>40	>45	>60	-	0.76
1	100 ²⁾	>40	>45	>60	>60	0.76

Saturation voltages:

	V_{CEsat}	V_{BEsat}	
($I_C = 10\text{ mA}$; $I_B = 0.25\text{ mA}$)	0.12 (<0.35)	0.7 (<0.85)	V
($I_C = 10\text{ mA}$; $I_B = 2.5\text{ mA}$) ²⁾	0.3 (<0.7)	0.9 (<1.2)	V
($I_C = 50\text{ mA}$; $I_B = 1.25\text{ mA}$) ¹⁾	0.1 (<0.7)	0.9 (<1.2)	V

		BCY 58	BCY 59	BCY 65E	
Collector cutoff current ($V_{CES} = 32\text{ V}$)	I_{CES}	0.2 (<10)	-	-	nA*
($V_{CES} = 45\text{ V}$)	I_{CES}	-	0.2 (<10)	-	nA*
($V_{CES} = 60\text{ V}$)	I_{CES}	-	-	0.2 (<10)	nA*
Collector cutoff current ($V_{CES} = 32\text{ V}$; $T_{amb} = 150^{\circ}\text{C}$)	I_{CES}	0.2 (<10)	-	-	μA
($V_{CES} = 45\text{ V}$; $T_{amb} = 150^{\circ}\text{C}$)	I_{CES}	-	0.2 (<10)	-	μA
($V_{CES} = 60\text{ V}$; $T_{amb} = 150^{\circ}\text{C}$)	I_{CES}	-	-	0.2 (<10)	μA
Collector cutoff current ($V_{CE} = 32\text{ V}$; $V_{BE} = 0.2\text{ V}$; $T_{amb} = 100^{\circ}\text{C}$)	I_{CEX}	<20	-	-	μA
($V_{CE} = 45\text{ V}$; $V_{BE} = 0.2\text{ V}$; $T_{amb} = 100^{\circ}\text{C}$)	I_{CEX}	-	<20	-	μA
($V_{CE} = 60\text{ V}$; $V_{BE} = 0.2\text{ V}$; $T_{amb} = 100^{\circ}\text{C}$)	I_{CEX}	-	-	<20	μA
Emitter cutoff current ($V_{EBO} = 5\text{ V}$)	I_{EBO}	<10	<10	<10	nA*
Collector-emitter breakdown voltage ($I_{CEO} = 2\text{ mA}$)	$V_{(BR)CEO}$	>32	>45	>60	V*
Emitter-base breakdown voltage ($I_{EBO} = 1\text{ }\mu\text{A}$)	$V_{(BR)EBO}$	>7	>7	>7	V*

1) applies only to BCY 65 E

2) applies only to BCY 58, BCY 59

*) AQL = 0.65%

Dynamic characteristics ($T_{amb} = 25^{\circ}\text{C}$)		BCY 58	BCY 59	BCY 65 E	
Transition frequency ($I_C = 10\text{ mA}$; $V_{CE} = 5\text{ V}$; $f = 100\text{ MHz}$)					
f_T		250 (>125)	250 (>125)	250 (>125)	MHz
Collector-base capacitance ($V_{CBO} = 10\text{ V}$; $f = 1\text{ MHz}$)					
C_{CBO}		3.5 (<6)	3.5 (<6)	3.5 (<6)	pF
Emitter-base capacitance ($V_{EBO} = 0.5\text{ V}$; $f = 1\text{ MHz}$)					
C_{EBO}		8 (<15)	8 (<15)	8 (<15)	pF
Noise figure ($I_C = 0.2\text{ mA}$; $V_{CE} = 5\text{ V}$; $R_g = 2\text{ k}\Omega$; $f = 1\text{ kHz}$; $\Delta f = 200\text{ Hz}$)					
NF		2 (<6)	2 (<6)	2 (<6)	dB

Four-pole characteristics ($I_C = 2\text{ mA}$; $V_{CE} = 5\text{ V}$; $f = 1\text{ kHz}$)

h_{FE} group	VII	VIII	IX	X	
h_{11e}	2.7 (1.6 to 4.5)	3.6 (2.5 to 6)	4.5 (3.2 to 8.5)	7.5 (4.5 to 12)	k Ω
h_{12e}	1.5	2	2	3	10^{-4}
h_{21e}	200	260	330	520	-
h_{22e}	18 (<30)	24 (<50)	30 (<60)	50 (<100)	μS

Switching times:

Operating point: BCY 58; BCY 59; BCY 65 E

$I_C : I_{B1} : -I_{B2}$ approx. 10:1:1 mA; $R_1 = 5\text{ k}\Omega$; $R_2 = 5\text{ k}\Omega$; $V_{BB} = 3.6\text{ V}$; $R_L = 990\text{ }\Omega$

t_d	35	ns	t_s	400	ns
t_r	50	ns	t_f	80	ns
t_{on}	85 (<150)	ns	t_{off}	480 (<800)	ns

Switching times:

Operating point: BCY 58; BCY 59

$I_C : I_{B1} : -I_{B2}$ approx. 100:10:10 mA; $R_1 = 500\text{ }\Omega$; $R_2 = 700\text{ }\Omega$; $V_{BB} = 5\text{ V}$; $R_L = 98\text{ }\Omega$

t_d	5	ns	t_s	250	ns
t_r	50	ns	t_f	200	ns
t_{on}	55 (<150)	ns	t_{off}	450 (<800)	ns

Switching times:

Operating point: BCY 65 E

$I_C : I_{B1} : -I_{B2}$ approx. 50:5:5 mA; $R_1 = 1\text{ k}\Omega$; $R_2 = 1.3\text{ k}\Omega$; $V_{BB} = 4.7\text{ V}$; $R_L = 195\text{ }\Omega$

t_d	15	ns	t_s	300	ns
t_r	50	ns	t_f	150	ns
t_{on}	65 (<150)	ns	t_{off}	450 (<800)	ns

Test circuit for switching times:

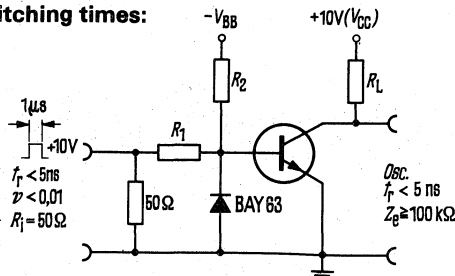

**BCY 58
BCY 59
BCY 65 E**

Total perm. power dissipation versus temperature

$P_{tot} = f(T)$; R_{th} = parameter;
 $V_{CE} \leq V_{CE0}$

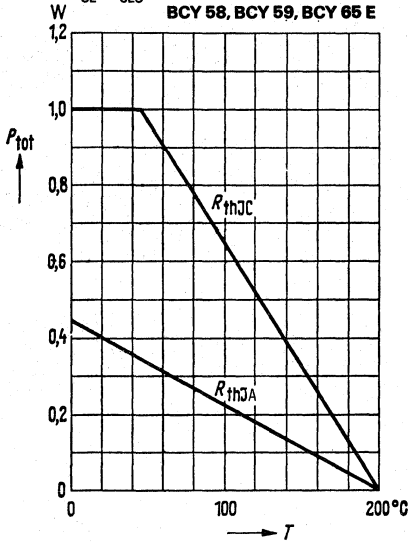

Permissible pulse load

$r_{thJC} = f(t)$; v = parameter

BCY 58, BCY 59, BCY 65 E

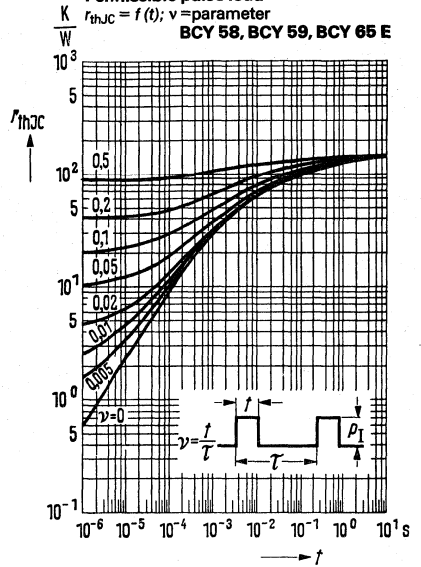

DC current gain $h_{FE} = f(I_C)$

$V_{CE} = 1V$; T_{amb} = parameter
(common emitter configuration)

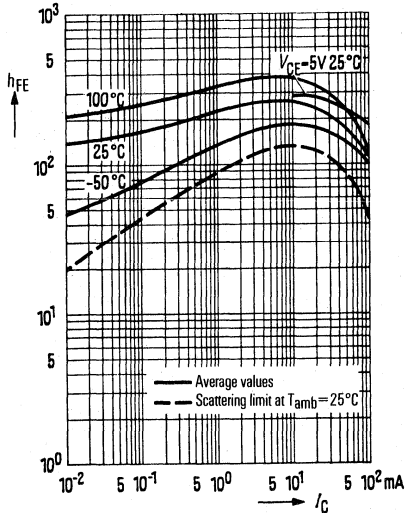

Collector current $I_C = f(V_{BE})$

$V_{CE} = 1V$

(common emitter configuration)

BCY 58, BCY 59, BCY 65 E

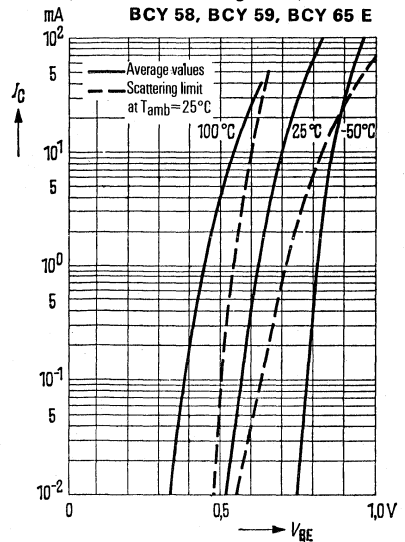

BCY 58
BCY 59
BCY 65 E

Collector-emitter saturation voltage

$V_{CEsat} = f(I_C); h_{FE} = 40$

$T_{amb} = \text{parameter}$

(common emitter configuration)

BCY 58, BCY 59, BCY 65 E

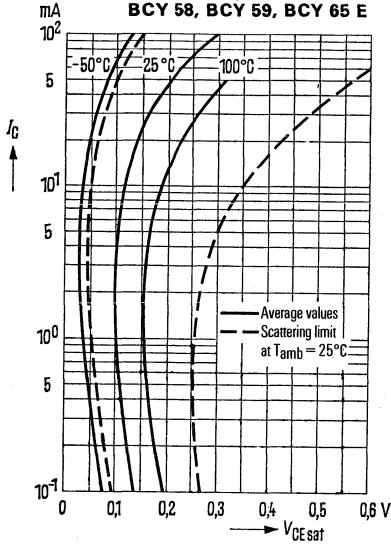

Base-emitter saturation voltage

$V_{BEsat} = f(I_C); T_{amb} = \text{parameter};$

$h_{FE} = 40$

(common emitter configuration)

BCY 58, BCY 59, BCY 65 E

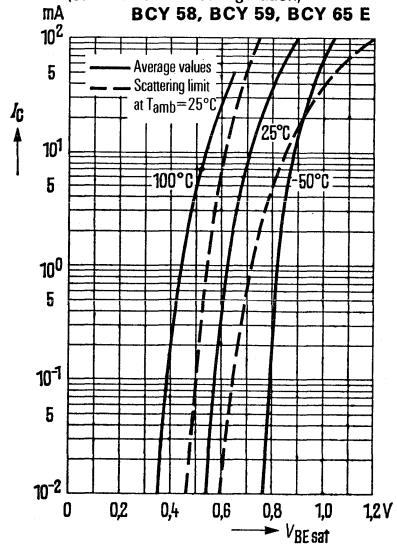

Collector-base capacitance

$C_{CBO} = f(V_{CBO})$

Emitter-base capacitance

$C_{EBO} = f(V_{EBO})$

BCY 58, BCY 59, BCY 65 E

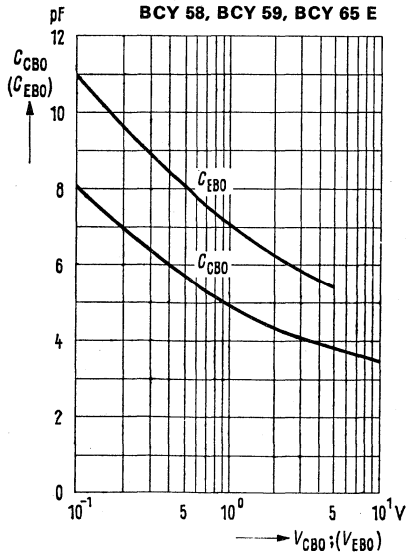

Transition frequency $f_T = f(I_C);$

$V_{CE} = \text{parameter}$

BCY 58, BCY 59, BCY 65 E

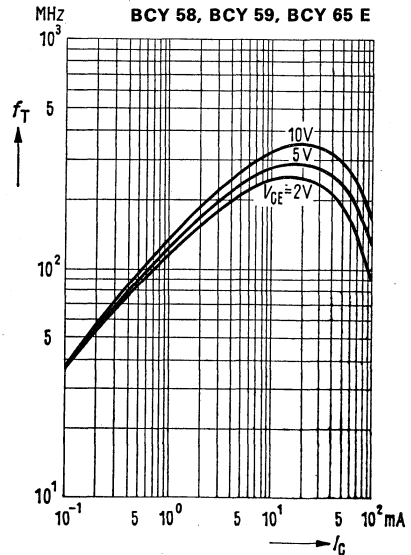

BCY 58
BCY 59
BCY 65 E

***h*-parameter versus collector current**

$$H_o = \frac{h_e(I_C)}{h_e(I_C = 2 \text{ mA})} = f(I_C); V_{CE} = 5 \text{ V}$$

BCY 58, BCY 59, BCY 65 E

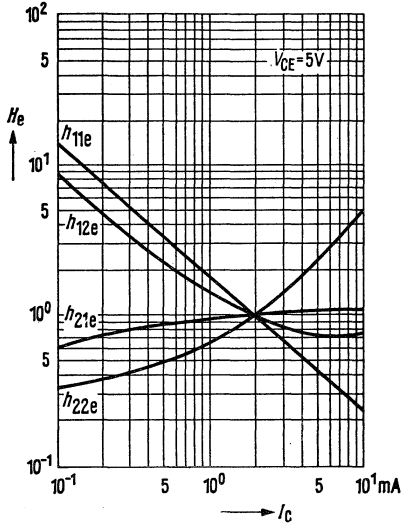

***h*-parameter versus collector-emitter voltage**

$$H_o = \frac{h_e(V_{CE})}{h_e(V_{CE} = 5 \text{ V})} = f(V_{CE}); I_C = 2 \text{ mA}$$

BCY 58, BCY 59, BCY 65 E

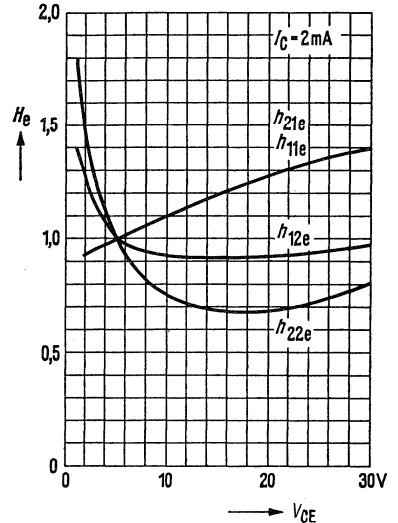

Input characteristic $I_B = f(V_{BE})$

$V_{CE} = 5 \text{ V}$
 (common emitter configuration)
BCY 58, BCY 59, BCY 65 E

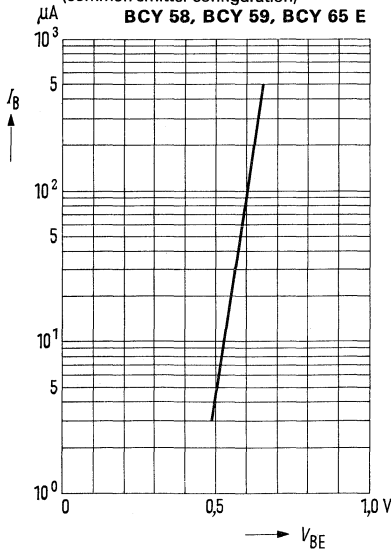

Collector cutoff current versus temperature $I_{CBO} = f(T_{amb})$ for max. permissible reverse voltage

BCY 58, BCY 59, BCY 65 E

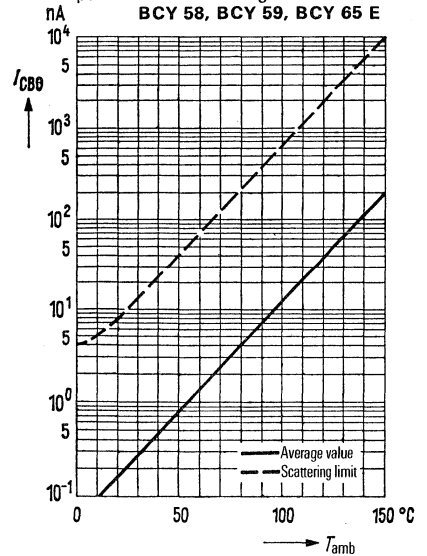

BCY 66 is an epitaxial NPN silicon planar transistor in TO 18 case (18 A 3 DIN 41876). The collector is electrically connected to the case. The transistor is particularly provided for low-noise AF input stages. The complementary transistor is BCY 67.

Type	Ordering code
BCY 66	Q60203-Y66

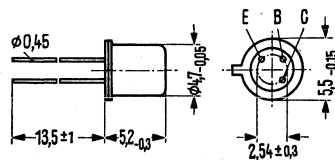

Approx. weight 0.3 g Dimensions in mm

Maximum ratings

Collector-emitter voltage	V_{CES}	45	V
Collector-emitter voltage	V_{CEO}	45	V
Emitter-base voltage	V_{EBO}	7	V
Collector current	I_C	50	mA
Base current	I_B	5	mA
Junction temperature	T_j	200	°C
Storage temperature range	T_{stg}	-65 to +200	°C
Total power dissipation ($T_{case} \leq 45^\circ C$)	P_{tot}	1	W

Thermal resistance

Junction to ambient air	R_{thJA}	≤ 450	K/W
Junction to case	R_{thJC}	≤ 150	K/W

Static characteristics ($T_{amb} = 25^\circ C$)

V_{CE} V	I_C mA	h_{FE} I_C/I_B	V_{BE} V
5	0.01	> 40	0.5
5	2	350 (180 to 630)	0.62 (0.55 to 0.7)*
1	10	120 to 1000 ¹⁾	0.7

Collector-emitter saturation voltage

($I_C = 10\text{ mA}; I_B = 0.25\text{ mA}$)

V_{CEsat}	0.12 (<0.35)	V
-------------	--------------	---

Base-emitter saturation voltage

($I_C = 10\text{ mA}; I_B = 0.25\text{ mA}$)

V_{BEsat}	0.7 (<0.85)	V
-------------	-------------	---

1) The upper limit applies to at least 90% of the transistors.
*) AQL = 0.65%

Static characteristics ($T_{amb} = 25^{\circ}\text{C}$)

Collector cutoff current ($V_{CES} = 45\text{ V}$)	I_{CES}	0.2 (<10)	nA
Collector cutoff current ($V_{CES} = 45\text{ V}$; $T_{amb} = 150^{\circ}\text{C}$)	I_{CES}	0.2 (<10)	μA
Emitter cutoff current ($V_{EBO} = 5\text{ V}$)	I_{EBO}	<10*	nA
Collector-emitter breakdown voltage ($I_{CEO} = 2\text{ mA}$)	$V_{(BR)CEO}$	>45*	V
Emitter-base breakdown voltage ($I_{EBO} = 1\text{ }\mu\text{A}$)	$V_{(BR)EBO}$	>7*	V

Dynamic characteristics ($T_{amb} = 25^{\circ}\text{C}$)

Transition frequency ($I_C = 10\text{ mA}$; $V_{CE} = 5\text{ V}$; $f = 100\text{ MHz}$)	f_T	250 (>125)	MHz
Collector-base capacitance ($V_{CBO} = 10\text{ V}$; $f = 1\text{ MHz}$)	C_{CBO}	3.5 (<6)	pF
Emitter-base capacitance ($V_{EBO} = 0.5\text{ V}$; $f = 1\text{ MHz}$)	C_{EBO}	8 (<15)	pF
Noise figure ($I_C = 0.2\text{ mA}$; $V_{CE} = 5\text{ V}$; $R_g = 2\text{ k}\Omega$; $f = 1\text{ kHz}$; $\Delta f = 200\text{ Hz}$)	NF	1.2 (<2)	dB
$I_C = 20\text{ }\mu\text{A}$; $V_{CE} = 5\text{ V}$; $f = 100\text{ Hz}$; $R_g = 10\text{ k}\Omega$	NF	<4	dB
$I_C = 20\text{ }\mu\text{A}$; $V_{CE} = 5\text{ V}$; $f = 1\text{ kHz}$; $R_g = 10\text{ k}\Omega$	NF	<2	dB
$I_C = 20\text{ }\mu\text{A}$; $V_{CE} = 5\text{ V}$; $f = 10\text{ kHz}$; $R_g = 10\text{ k}\Omega$	NF	<2	dB
$I_C = 200\text{ }\mu\text{A}$; $V_{CE} = 5\text{ V}$; $\Delta f = 15.7\text{ kHz}$; $R_g = 2\text{ k}\Omega$	NF	<3	dB

Equivalent, base referred noise voltage

($-I_C = 0.2\text{ mA}$; $-V_{CE} = 5\text{ V}$; $R_g = 2\text{ k}\Omega$; $f = 10\text{ to }50\text{ Hz}$)	E_n	<0.11	μV
---	-------	-------	---------------

Test circuit for noise voltage measurement

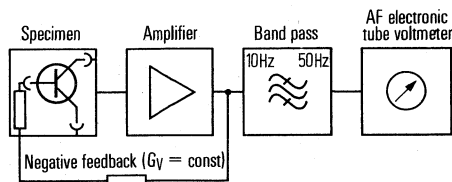

Four-pole characteristics ($I_C = 2\text{ mA}$; $V_{CE} = 5\text{ V}$; $f = 1\text{ kHz}$)

h_{11e}	4.5 (2.5 to 12)	$\text{k}\Omega$
h_{12e}	2	10^{-4}
h_{21e}	330	-
h_{22e}	30 (<100)	μS

* AQL = 0.65%

Total perm. power dissipation versus temperature

$P_{tot} = f(T); R_{th} = \text{parameter}$

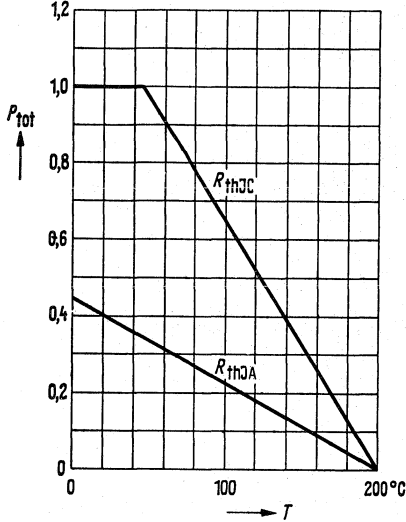

Permissible pulse load

$K_{r_{thJC}} = f(t); v = \text{parameter}$

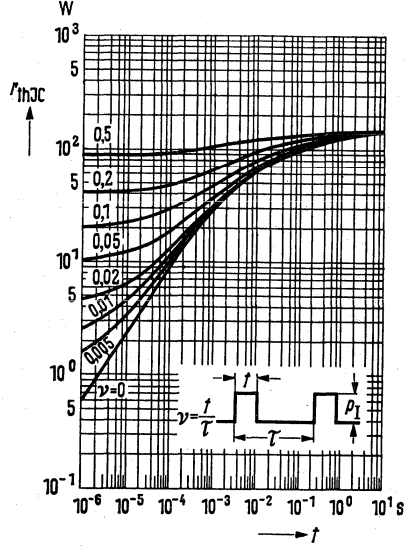

DC current gain $h_{FE} = f(I_C)$

$V_{CE} = 1V; T_{amb} = \text{parameter}$

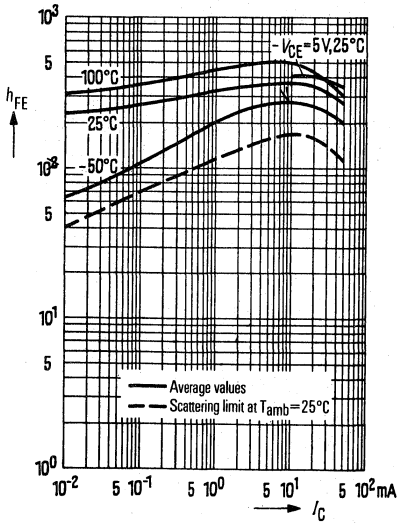

Collector current $I_C = f(V_{BE})$

$V_{CE} = 1V$
mA (common emitter configuration)

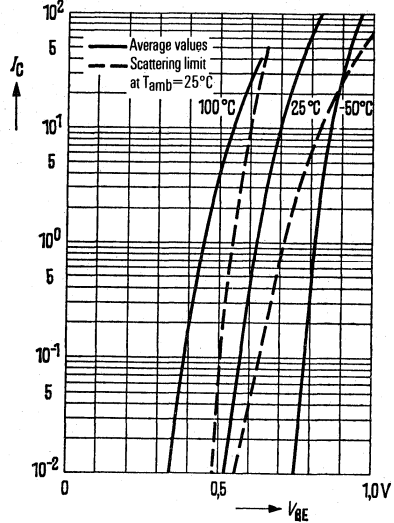

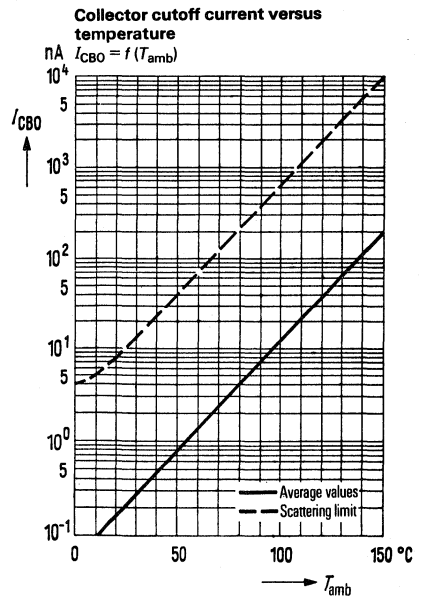
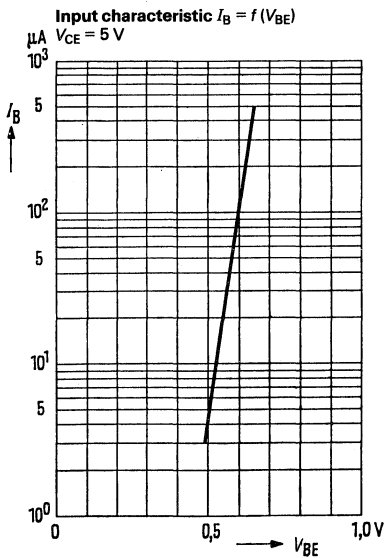
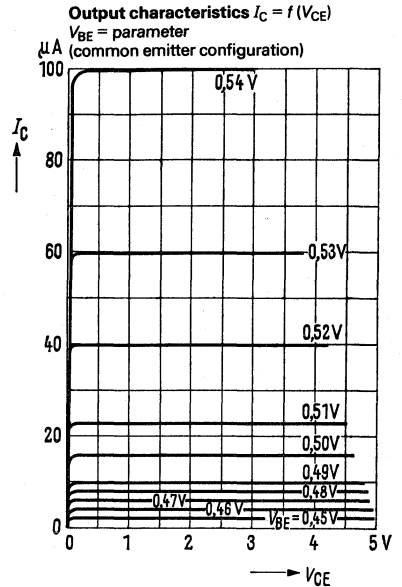
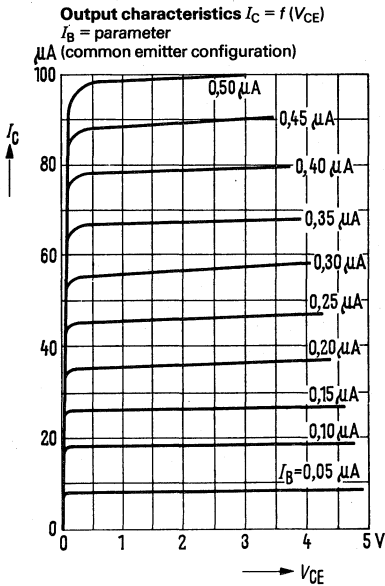

Transition frequency $f_T = f(I_C)$
 $V_{CE} = \text{parameter}$

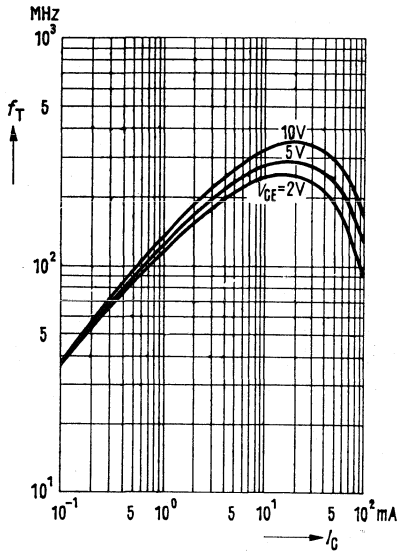

Collector-base capacitance
 $C_{CBO} = f(V_{CBO})$
Emitter-base capacitance
 $C_{EBO} = f(V_{EBO})$

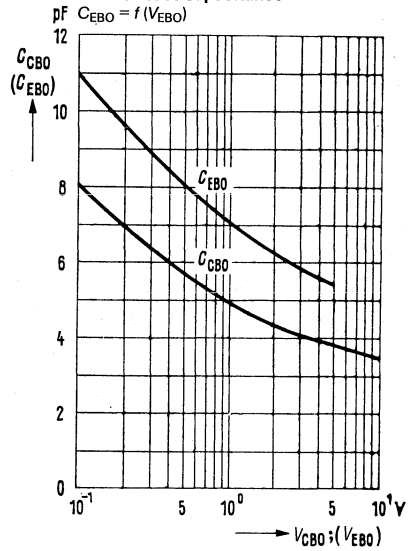

h -parameter versus collector current

$$H_o = \frac{h_e(I_C)}{h_o(I_C = 2 \text{ mA})} = f(I_C)$$

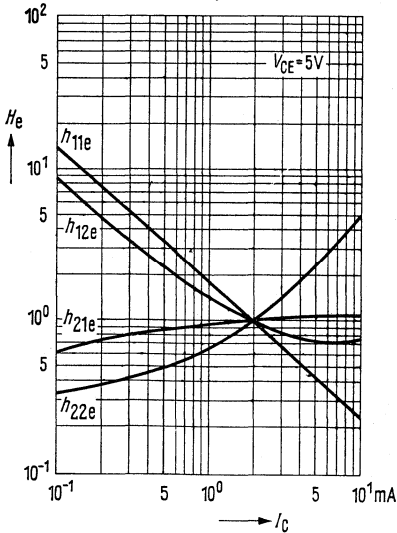

h -parameter versus collector-emitter voltage

$$H_o = \frac{h_e(V_{CE})}{h_e(V_{CE} = 5 \text{ V})} = f(V_{CE})$$

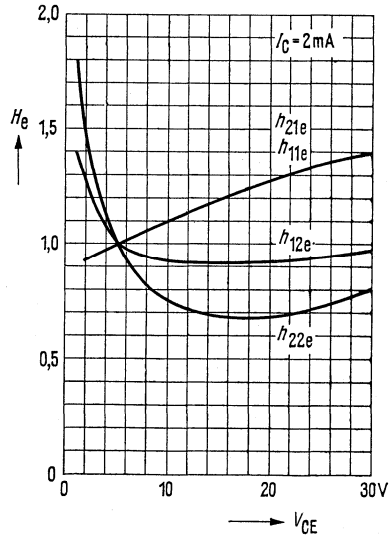

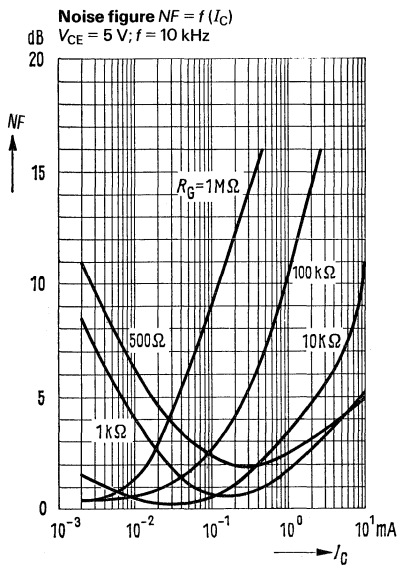
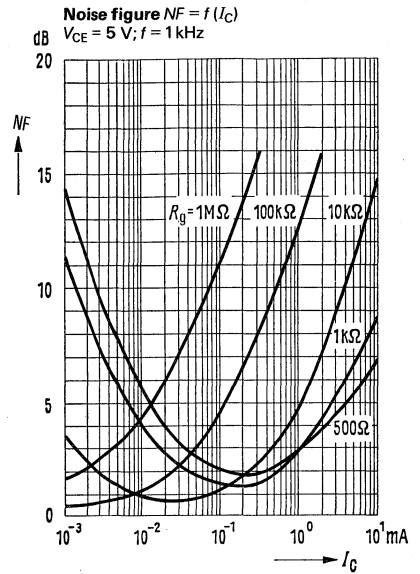
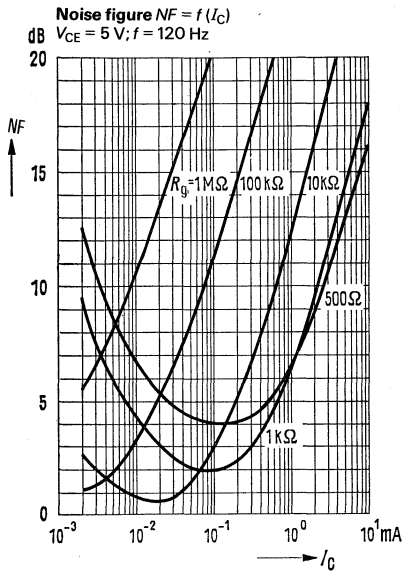

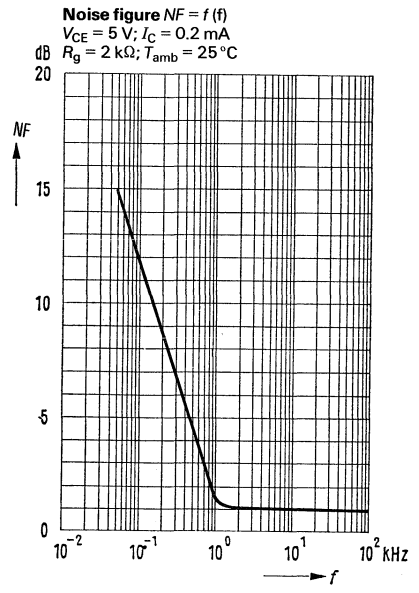
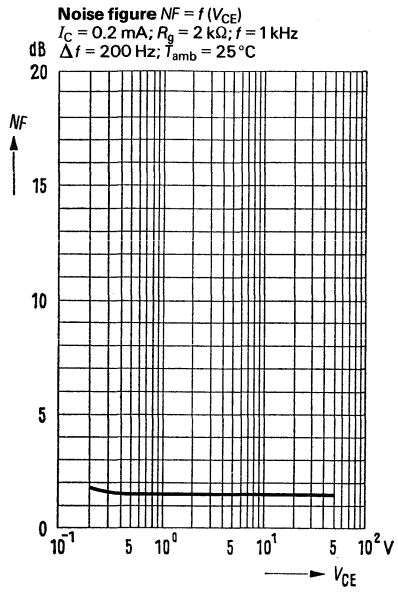

BCY 67 is an epitaxial PNP silicon planar transistor in TO 18 case (18 A 3 DIN 41876). The collector is electrically connected to the case. The transistor is particularly provided for low-noise AF input stages. The complementary transistor is BCY 66.

Type	Ordering code
BCY 67	Q62702-C254

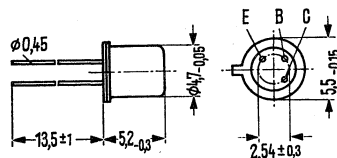

Approx. weight 0.3 g Dimensions in mm

Maximum ratings

Collector-emitter voltage	$-V_{CES}$	45	V
Collector-emitter voltage	$-V_{CEO}$	45	V
Emitter-base voltage	$-V_{EBO}$	5	V
Collector current	$-I_C$	50	mA
Base current	$-I_B$	5	mA
Junction temperature	T_j	200	°C
Storage temperature range	T_{stg}	-65 to +200	°C
Total power dissipation ($T_{case} = 45^\circ\text{C}$)	P_{tot}	1	W

Thermal resistance

Junction to ambient air	R_{thJA}	≤ 450	K/W
Junction to case	R_{thJC}	≤ 150	K/W

Static characteristics ($T_{amb} = 25^\circ\text{C}$)

$-V_{CE}$ V	$-I_C$ mA	h_{FE} I_C/I_B	$-V_{BE}$ V
5	0.01	> 40	0.5
5	2	350 (180 to 630)	0.62 (0.55 to 0.7)
1	10	120 to 1000 ¹⁾	0.7

Collector-emitter saturation voltage ($I_C = 10\text{ mA}$; $I_B = 0.25\text{ mA}$)	$-V_{CEsat}$	0.12 (<0.25)	V
Base-emitter saturation voltage ($I_C = 10\text{ mA}$; $I_B = 0.25\text{ mA}$)	$-V_{BEsat}$	0.7 (<0.85)	V

1) The upper limit applies to at least 90% of the transistors.

Static characteristics ($T_{amb} = 25^{\circ}\text{C}$)

Collector cutoff current ($-V_{CES} = 45\text{ V}$)	$-I_{CES}$	2 (<10)*	nA
Collector cutoff current ($-V_{CES} = 35\text{ V}$; $T_{amb} = 150^{\circ}\text{C}$)	$-I_{CES}$	<10	μA
Emitter cutoff current ($-V_{EBO} = 4\text{ V}$)	$-I_{EBO}$	<20	nA
Collector-emitter breakdown voltage ($-I_{CEO} = 2\text{ mA}$)	$-V$	>45*	V
Collector-emitter breakdown voltage ($-I_{CES} = 10\ \mu\text{A}$)	$-V_{(BR)CES}$	>45	V
Emitter-base breakdown voltage ($-I_{EBO} = 1\ \mu\text{A}$)	$-V_{(BR)EBO}$	>5*	V

Dynamic characteristics ($T_{amb} = 25^{\circ}\text{C}$)

Transition frequency ($-I_C = 10\text{ mA}$; $-V_{CE} = 5\text{ V}$)	f_T	180	MHz
Collector-base capacitance ($-V_{CBO} = 10\text{ V}$; $f = 1\text{ MHz}$)	C_{CBO}	4.5 (<7)	pF
Emitter-base capacitance ($-V_{EBO} = 0.5\text{ V}$)	C_{EBO}	11 (<15)	pF
Noise figure $-I_C = 0.2\text{ mA}$; $-V_{CE} = 5\text{ V}$; $R_g = 2\text{ k}\Omega$; $f = 1\text{ kHz}$; $\Delta f = 200\text{ Hz}$	NF	1.2 (<2)	dB
$-I_C = 20\ \mu\text{A}$; $-V_{CE} = 5\text{ V}$; $R_g = 10\text{ k}\Omega$; $f = 100\text{ Hz}$	NF	<4	dB
$-I_C = 20\ \mu\text{A}$; $-V_{CE} = 5\text{ V}$; $R_g = 10\text{ k}\Omega$; $f = 1\text{ kHz}$	NF	<2	dB
$-I_C = 20\ \mu\text{A}$; $-V_{CE} = 5\text{ V}$; $R_g = 10\text{ k}\Omega$; $f = 10\text{ kHz}$	NF	<2	dB
$-I_C = 200\ \mu\text{A}$; $-V_{CE} = 5\text{ V}$; $R_g = 2\text{ k}\Omega$; $\Delta f = 15.7\text{ kHz}$	NF	<3	dB

Equivalent, base referred noise voltage

($I_C = 0.2\text{ mA}$; $V_{CE} = 5\text{ V}$; $R_g = 2\text{ k}\Omega$; $f = 10\text{ to }50\text{ Hz}$)	E_n	<0.135	μV
---	-------	--------	---------------

Test circuit for noise voltage measurement

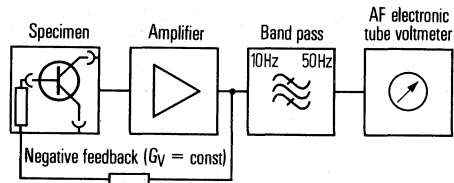

Four-pole characteristics ($-I_C = 2\text{ mA}$; $-V_{CE} = 5\text{ V}$; $f = 1\text{ kHz}$)

h_{11e}	4.5 (2.5 to 12)	$\text{k}\Omega$
h_{12e}	2	10^{-4}
h_{21e}	330	-
h_{22e}	30 (<100)	μS

* AQL = 0.65%

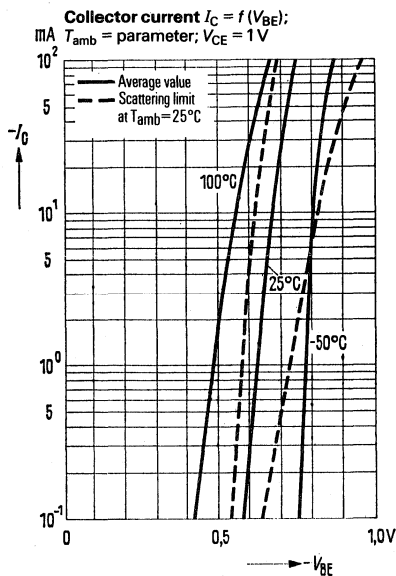
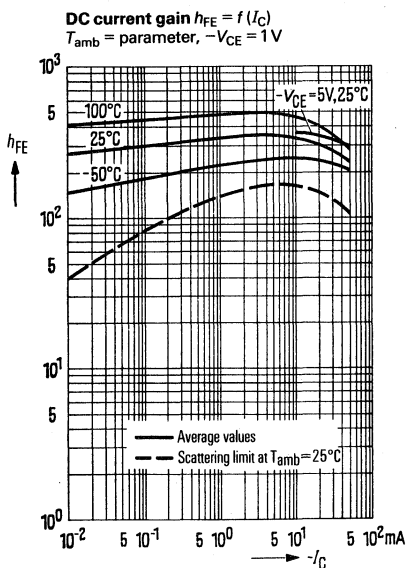
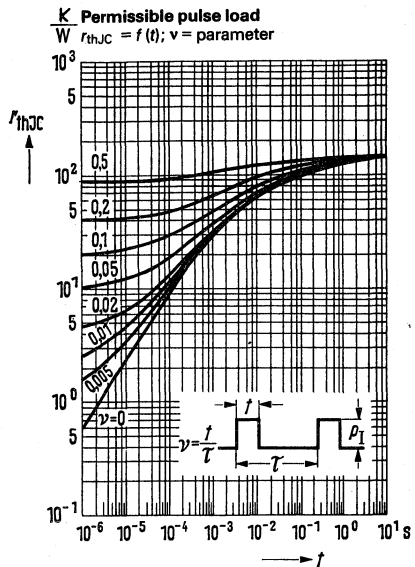
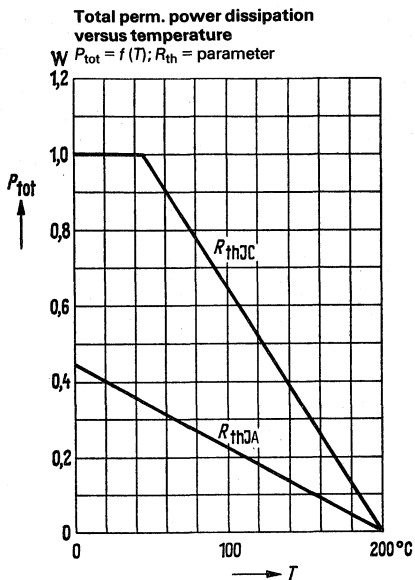

Collector cutoff current versus temperature $I_{CBO} = f(T_{amb})$

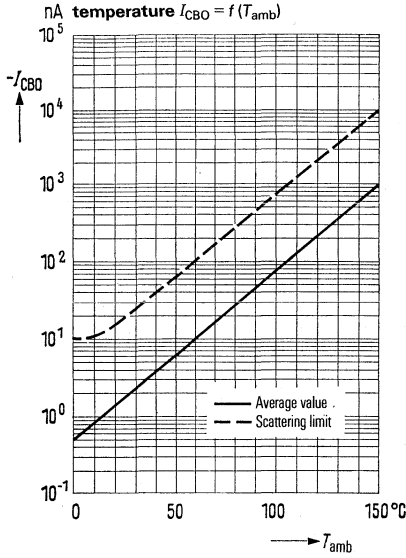

Transition frequency $f_T = f(I_C)$
MHz $T_{amb} = 25^\circ\text{C}$

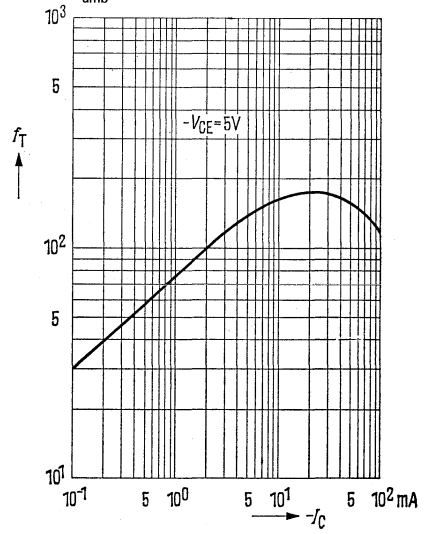

Collector-base capacitance

$C_{CBO} = f(V_{CBO})$

Emitter-base capacitance

$C_{EBO} = f(V_{EBO})$

pF $T_{amb} = 25^\circ\text{C}; f = 1\text{ MHz}$

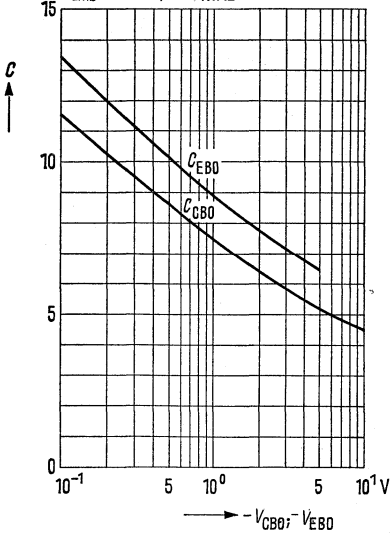

Input characteristic $I_B = f(V_{BE})$

$V_{CE} = 5\text{ V}; T_{amb} = 25^\circ\text{C}$

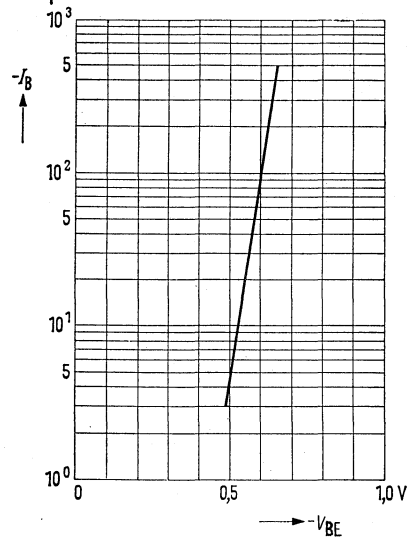

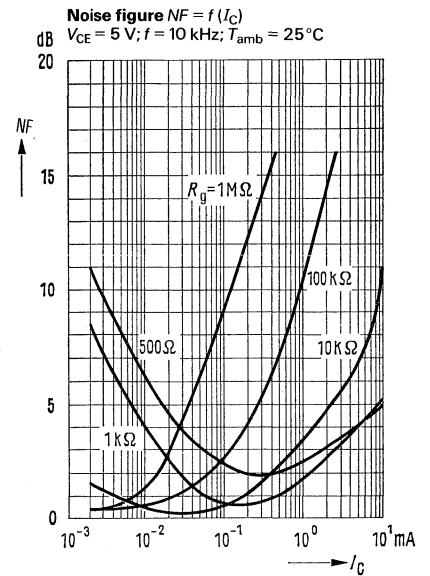
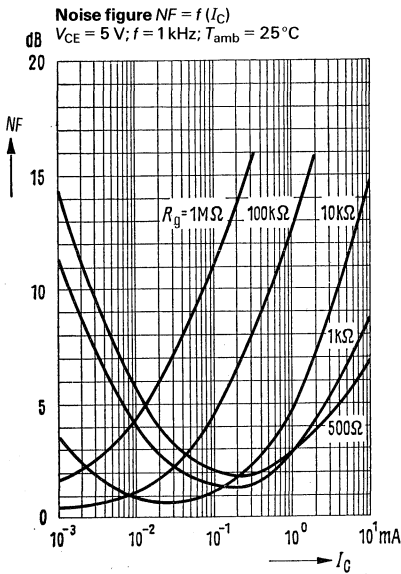
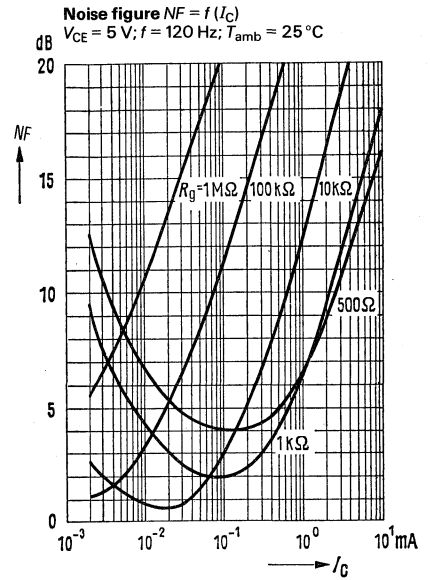
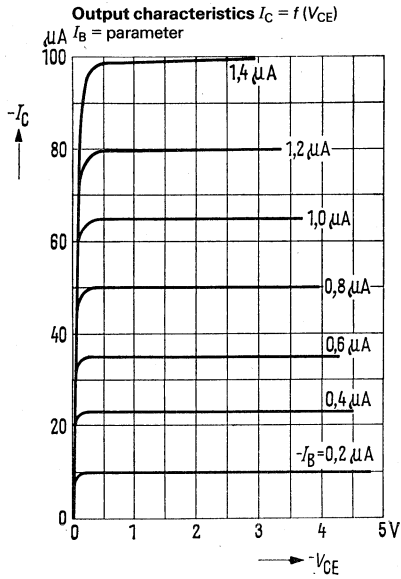

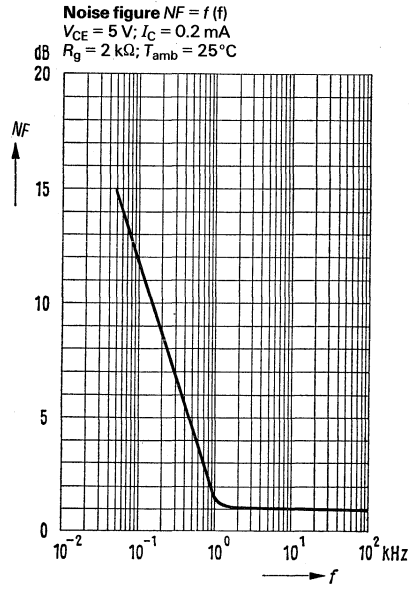
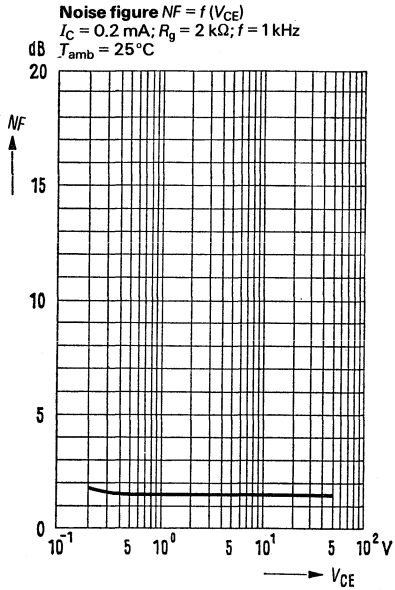

h -parameter versus collector current

$$H_e = \frac{h_e(I_C)}{h_e(I_C = 2 \text{ mA})} = f(I_C)$$

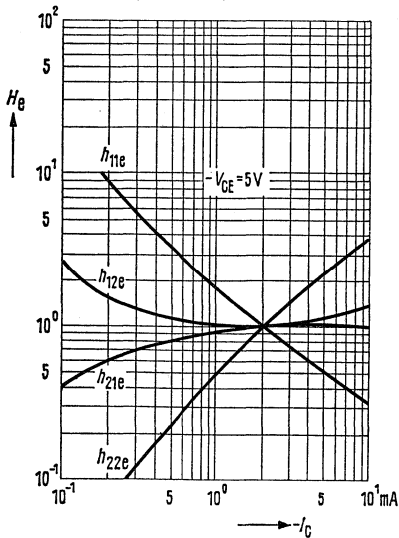

h -parameter versus collector-emitter voltage

$$H_e = \frac{h_e(V_{CE})}{h_e(V_{CE} = 5 \text{ V})} = f(V_{CE})$$

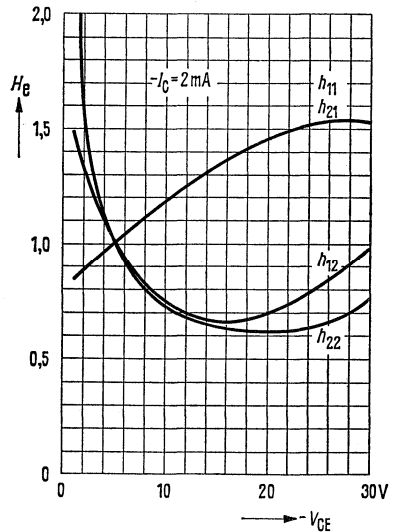

BCY 77, BCY 78, and BCY 79 are epitaxial PNP silicon planar transistors in TO 18 cases (18 A 3 DIN 41876). The collector is electrically connected to the case. The transistors are particularly suitable for low noise AF input and driver stages. They can be used as complementary types to BCY 58, BCY 59, and BCY 65 E.

Type	Ordering code
BCY 77	Q62702-C327
BCY 77 VII	Q62702-C327-V1
BCY 77 VIII	Q62702-C327-V2
BCY 77 IX	Q62702-C327-V3
BCY 78	Q60203-Y78
BCY 78 VII	Q60203-Y78-G
BCY 78 VIII	Q60203-Y78-H
BCY 78 IX	Q60203-Y78-J
BCY 78 X	Q60203-Y78-K
BCY 79	Q60203-Y79
BCY 79 VII	Q60203-Y79-G
BCY 79 VIII	Q60203-Y79-H
BCY 79 IX	Q60203-Y79-J

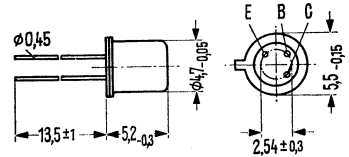

Approx. weight 0.3 g Dimensions in mm

Maximum ratings

Collector-emitter voltage	$-V_{CES}$	60	32	45	V
Collector-emitter voltage	$-V_{CEO}$	60	32	45	V
Emitter-base voltage	$-V_{EBO}$	5	5	5	V
Collector current	$-I_C$	100	200	200	mA
Base current	$-I_B$	50	50	50	mA
Junction temperature	T_j	200	200	200	°C
Storage temperature range	T_{stg}		-65 to +200		°C
Total power dissipation ($T_{case} = 45^\circ\text{C}$)	P_{tot}	1	1	1	W

	BCY 77	BCY 78	BCY 79	
$-V_{CES}$	60	32	45	V
$-V_{CEO}$	60	32	45	V
$-V_{EBO}$	5	5	5	V
$-I_C$	100	200	200	mA
$-I_B$	50	50	50	mA
T_j	200	200	200	°C
T_{stg}		-65 to +200		°C
P_{tot}	1	1	1	W

Thermal resistance

Junction to ambient air	R_{thJA}	≤ 450	≤ 450	≤ 450	K/W
Junction to case	R_{thJC}	≤ 150	≤ 150	≤ 150	K/W

R_{thJA}	≤ 450	≤ 450	≤ 450	K/W
R_{thJC}	≤ 150	≤ 150	≤ 150	K/W

Static characteristics ($T_{amb} = 25^{\circ}\text{C}$)

The transistors BCY 77, BCY 78, and BCY 79 are classified in groups of DC current gain h_{FE} and marked by Roman numerals.

Type	BCY 77 BCY 78 BCY 79	BCY 77 BCY 78 BCY 79	BCY 77 BCY 78 BCY 79	– BCY 78 –	BCY 77 BCY 78 BCY 79	
h_{FE} group	VII	VIII	IX	X		
$-V_{CE}$ V	$-I_C$ mA	h_{FE} I_C/I_B	h_{FE} I_C/I_B	h_{FE} I_C/I_B	h_{FE} I_C/I_B	$-V_{BE}$ V
5	0.01	140	200 (>30)	270 (>40)	340 (>100)	0.55
5	2	170 (120 to 220)	250 (180 to 310)	350 (250 to 460)	500 (380 to 630)	0.65 (0.6 to 0.75)*
1	10	180 (>80)	260 (120 to 400)	360 (160 to 630)	500 (240 to 1000)	0.68
1 ¹⁾	100	>40	>45	>60	>60	0.75
1 ²⁾	50	>40	>45	>60	>60	0.72

Saturation voltages

($I_C = 10\text{ mA}$; $I_B = 0.25\text{ mA}$)
($I_C = 100\text{ mA}$; $I_B = 2.5\text{ mA}$)¹⁾
($I_C = 50\text{ mA}$; $I_B = 1.25\text{ mA}$)²⁾

$-V_{CEsat}$	$-V_{BEsat}$	
0.12 (<0.25)	0.7 (<0.85)	V
0.4 (<0.8)	0.85 (<1.2)	V
0.4 (<0.8)	0.85 (<1.2)	V

1) applies only to BCY 78, BCY 79

2) applies only to BCY 77

*) AQL = 0.65%

Static characteristics ($T_{amb} = 25^{\circ}\text{C}$)		BCY 77	BCY 78	BCY 79	
Collector cutoff current ($-V_{CES} = 50\text{ V}$)	$-I_{CES}$	2 (<20)	-	-	nA*
Collector cutoff current ($-V_{CES} = 25\text{ V}$)	$-I_{CES}$	-	2 (<20)	-	nA*
Collector cutoff current ($-V_{CES} = 35\text{ V}$)	$-I_{CES}$	-	-	2 (<20)	nA*
Collector cutoff current ($-V_{CES} = 60\text{ V}$)	$-I_{CES}$	<100	-	-	nA*
Collector cutoff current ($-V_{CES} = 32\text{ V}$)	$-I_{CES}$	-	<100	-	nA
Collector cutoff current ($-V_{CES} = 45\text{ V}$)	$-I_{CES}$	-	-	<100	nA
Collector cutoff current ($-V_{CES} = 60\text{ V}; T_{amb} = 150^{\circ}\text{C}$)	$-I_{CES}$	<10	-	-	μA
Collector cutoff current ($-V_{CES} = 25\text{ V}; T_{amb} = 150^{\circ}\text{C}$)	$-I_{CES}$	-	<10	-	μA
Collector cutoff current ($-V_{CES} = 35\text{ V}; T_{amb} = 150^{\circ}\text{C}$)	$-I_{CES}$	-	-	<10	μA
Collector cutoff current ($-V_{CE} = 60\text{ V}; V_{BE} = 0.2\text{ V};$ $T_{amb} = 100^{\circ}\text{C}$)	$-I_{CEX}$	<20	-	-	μA
Collector cutoff current ($-V_{CE} = 32\text{ V}; V_{BE} = 0.2\text{ V};$ $T_{amb} = 100^{\circ}\text{C}$)	$-I_{CEX}$	-	<20	-	μA
Collector cutoff current ($-V_{CE} = 45\text{ V}; V_{BE} = 0.2\text{ V};$ $T_{amb} = 100^{\circ}\text{C}$)	$-I_{CEX}$	-	-	<20	μA
Emitter cutoff current ($-V_{EBO} = 4\text{ V}$)	$-I_{EBO}$	<20	<20	<20	nA*
Emitter-base breakdown voltage ($-I_{EBO} = 1\text{ }\mu\text{A}$)	$-V_{(BR)EBO}$	>5	>5	>5	V*
Collector-emitter breakdown voltage ($-I_{CEO} = 2\text{ mA}$)	$-V_{(BR)CEO}$	>60	>32	>45	V*
Collector-emitter breakdown voltage ($-I_{CES} = 10\text{ }\mu\text{A}$)	$-V_{(BR)CES}$	>60	>32	>45	V

* AQL = 0.65%

Dynamic characteristics ($T_{amb} = 25^\circ\text{C}$)

BCY 77, BCY 78, BCY 79

Transition frequency ($-I_C = 10\text{ mA}$; $-V_{CE} = 5\text{ V}$; $f = 100\text{ MHz}$)	f_T	180	MHz
Collector-base capacitance ($-V_{CBO} = 10\text{ V}$; $f = 1\text{ MHz}$)	C_{CBO}	4.5 (<7)	pF
Emitter-base capacitance ($-V_{EBO} = 0.5\text{ V}$; $f = 1\text{ MHz}$)	C_{EBO}	11 (<15)	pF
Noise figure ($-I_C = 0.2\text{ mA}$; $-V_{CE} = 5\text{ V}$; $R_g = 2\text{ k}\Omega$; $f = 1\text{ kHz}$; $\Delta f = 200\text{ Hz}$)	NF	2 (<6)	dB

Four-pole parameter ($-I_C = 2\text{ mA}$; $-V_{CE} = 5\text{ V}$; $f = 1\text{ kHz}$)

Type	BCY 77 BCY 78 BCY 79	BCY 77 BCY 78 BCY 79	BCY 77 BCY 78 BCY 79	— BCY 78 —	
h_{FE} group	VII	VIII	IX	X	
h_{11e}	2.7 (1.6–4.5)	3.6 (2.5–6)	4.5 (3.2–8.5)	7.5	k Ω
h_{12e}	1.5	2	2	3	10^{-4}
h_{21e}	200	260	330	520	—

Switching times

BCY 77, BCY 78, BCY 79 Operating point:

$I_C: I_{B1}: I_{B2}$ 10:1:1 mA; $R_1 = 5\text{ k}\Omega$; $R_2 = 5\text{ k}\Omega$; $V_{BB} = 3.6\text{ V}$; $R_L = 990\ \Omega$

t_d	35	ns	t_s	400	ns
t_r	50	ns	t_f	80	ns
t_{on}	85 (<150)	ns	t_{off}	480 (<800)	ns

BCY 78, BCY 79 Operating point:

$I_C: I_{B1}: I_{B2}$ approx. 100:10:10 mA; $R_1 = 500\ \Omega$; $R_2 = 700\ \Omega$; $V_{BB} = 5\text{ V}$; $R_L = 98\ \Omega$

t_d	5	ns	t_s	250	ns
t_r	50	ns	t_f	200	ns
t_{on}	55 (<150)	ns	t_{off}	450 (<800)	ns

BCY 77 Operating point:

$I_C: I_{B1}: I_{B2}$ approx. 50:5:5 mA; $R_1 = 1\text{ k}\Omega$; $R_2 = 1.3\text{ k}\Omega$; $V_{BB} = 4.7\text{ V}$; $R_L = 195\ \Omega$

t_d	15	ns	t_s	300	ns
t_r	50	ns	t_f	150	ns
t_{on}	65 (<150)	ns	t_{off}	450 (<800)	ns

Test circuit for switching times:

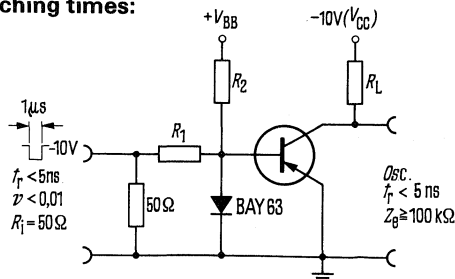

BCY 77 BCY 78 BCY 79

Total perm. power dissipation versus temperature

$P_{tot} = f(T)$; R_{th} = parameter; $V_{CE} \leq V_{CEO}$
BCY 77, BCY 78, BCY 79

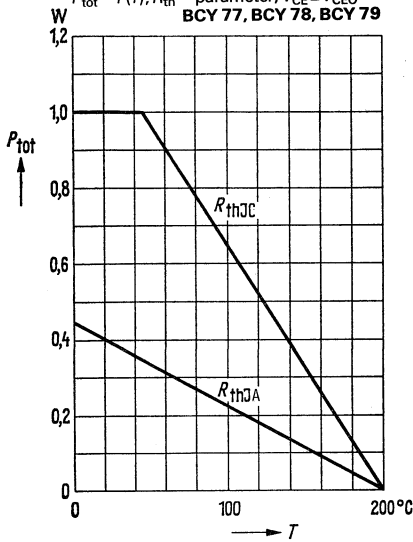

Permissible pulse load

$r_{thJC} = f(t)$; $v =$ parameter
BCY 77, BCY 78, BCY 79

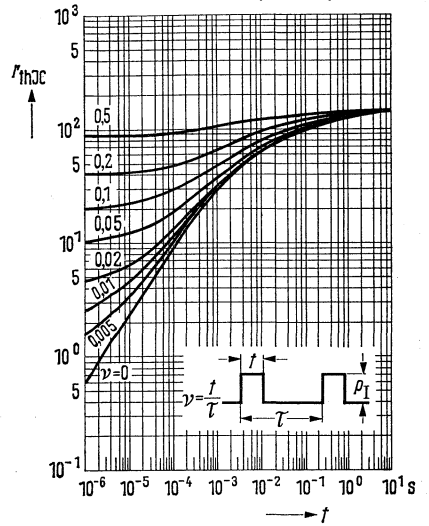

Collector current $I_C = f(V_{BE})$

($V_{CE} = 1V$)
 T_{amb} = parameter
BCY 77, BCY 78, BCY 79

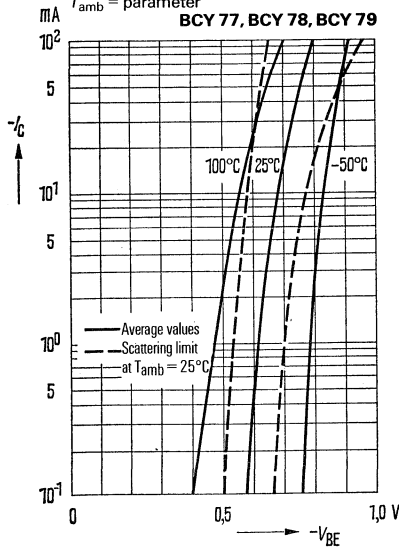

DC current gain $h_{FE} = f(I_C)$

($V_{CE} = 1V$; T_{amb} = parameter)
BCY 78 VIII, BCY 79 VIII

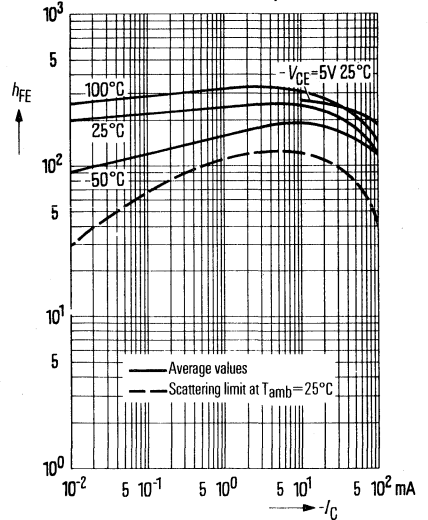

Collector-emitter saturation voltage
 $V_{CEsat} = f(I_C); h_{FE} = 40; T_{amb} = \text{parameter}$

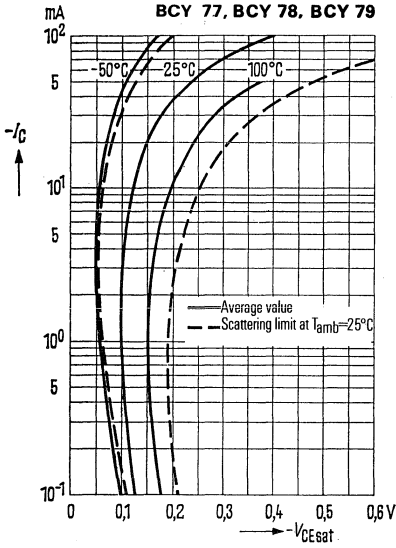

Base-emitter saturation voltage
 $V_{BEsat} = f(I_C); h_{FE} = 40; T_{amb} = \text{parameter}$

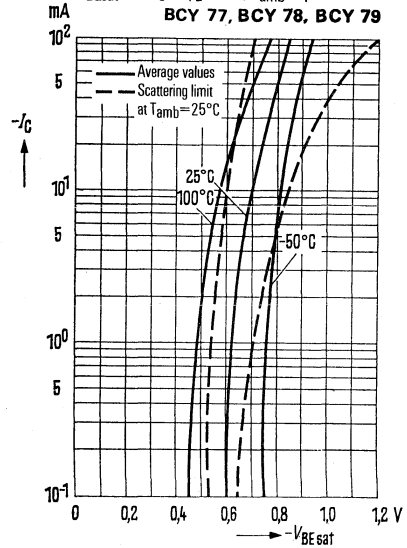

Input characteristic $I_B = f(V_{BE})$
 $V_{CE} = 5\text{ V}; T_{amb} = 25^\circ\text{C}$

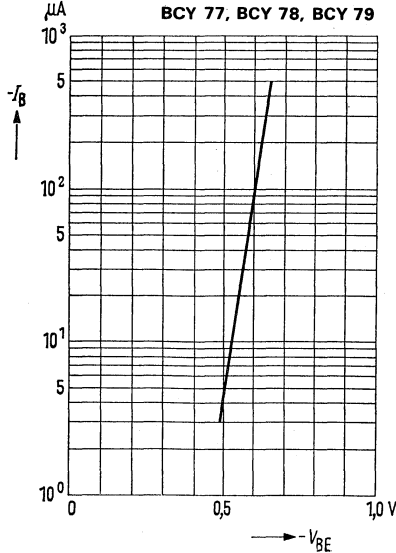

Collector cutoff current versus temperature $I_{CBO} = f(T_{amb})$ for max. permissible reverse voltage

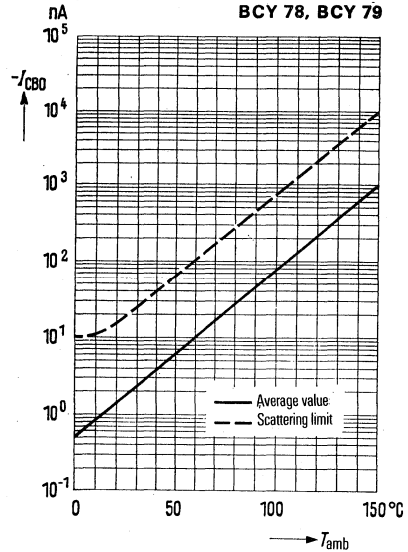

BCY 77 BCY 78 BCY 79

h-parameter versus collector current

$$H_e = \frac{h_e(I_C)}{h_e(I_C = 2 \text{ mA})} = f(I_C)$$

BCY 77, BCY 78, BCY 79

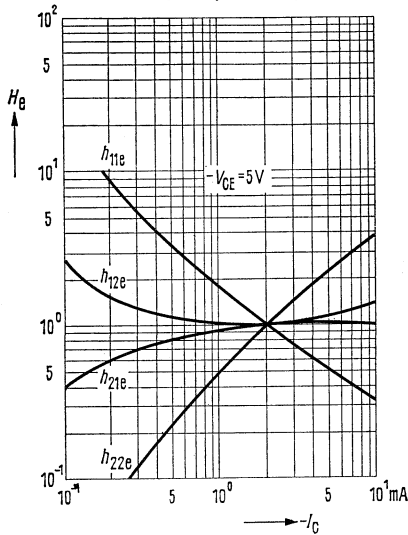

h-parameter versus collector-emitter voltage

$$H_e = \frac{h_e(V_{CE})}{h_e(V_{CE} = 5 \text{ V})} = f(V_{CE})$$

BCY 77, BCY 78, BCY 79

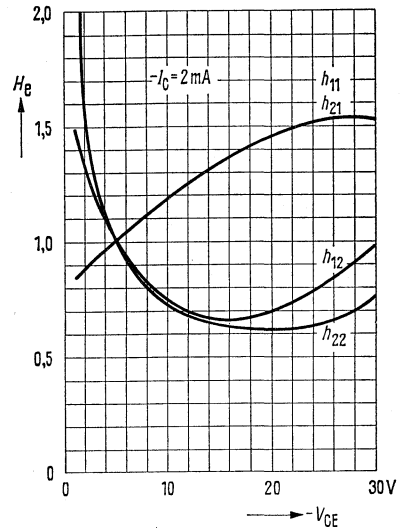

Collector-base capacitance

$$C_{CB0} = f(V_{CB0})$$

Emitter-base capacitance

$$C_{EB0} = f(V_{EB0})$$

$$f = 1 \text{ MHz}; T_{\text{amb}} = 25^\circ\text{C}$$

BCY 78, BCY 79

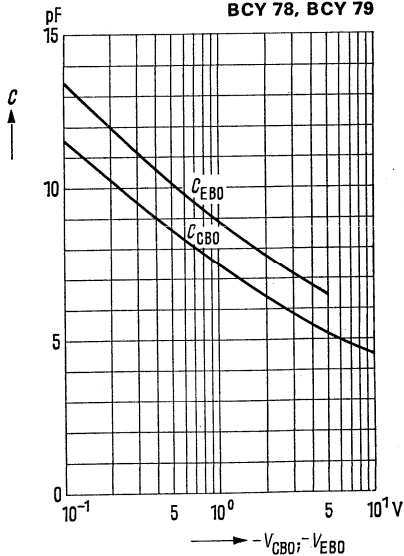

Transition frequency $f_T = f(I_C)$

$$-V_{CE} = 5 \text{ V}; T_{\text{amb}} = 25^\circ\text{C}$$

BCY 78, BCY 79

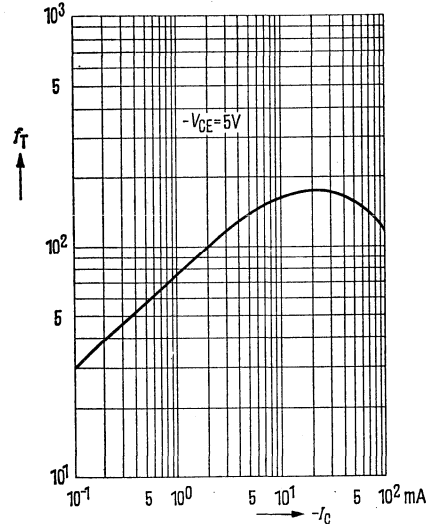

For AF driver and output stages of medium performance

BD 135, BD 137, and BD 139 are epitaxial NPN silicon planar transistors in TO 126 plastic package (12 A 3 DIN 41869, sheet 4). The collector is electrically connected to the metallic mounting area. Together with BD 136, BD 138, and BD 140 as complementary pairs the transistors BD 135, BD 137, and BD 139 are designed for use in driver stages of high performance AF amplifiers.

Type	Ordering code
BD 135	Q62702-D106
BD 135-6	Q62702-D106-V1
BD 135-10	Q62702-D106-V2
BD 135-16	Q62702-D106-V3
BD 135 paired	Q62702-D106-P
BD 137	Q62702-D108
BD 137-6	Q62702-D108-V1
BD 137-10	Q62702-D108-V2
BD 137 paired	Q62702-D108-P
BD 139	Q62702-D110
BD 139-6	Q62702-D110-V1
BD 139-10	Q62702-D110-V2
BD 139 paired	Q62702-D110-P
BD 135/BD 136 compl. pair.	Q62702-D139-S1
BD 137/BD 138 compl. pair.	Q62702-D140-S1
BD 139/BD 140 compl. pair.	Q62702-D141-S1

Type	Ordering code
Mica washer	Q62902-B62
Spring washer	Q62902-B63
A 3 DIN 137	

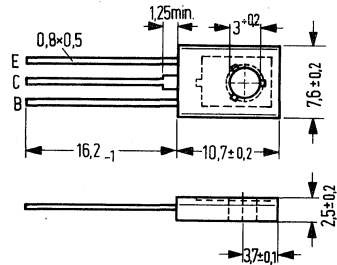

Approx. weight 0.5 g Dimensions in mm

Transistor fixing with M 3 screw. Starting torque < 0.8 Nm; washer or spring washer should be used.

1) If a 50 μ mica washer (ungreased) is used, the thermal resistance increases by 8 K/W and in case of a greased one by 4 K/W.

Maximum ratings

	BD 135	BD 137	BD 139		
Collector-emitter voltage ($R_{BE} \leq 1 \text{ k}\Omega$)	V_{CER}	—	—	100	V
Collector-base voltage	V_{CBO}	45	60	—	V
Collector-emitter voltage	V_{CEO}	45	60	80	V
Emitter-base voltage	V_{EBO}	5	5	5	V
Collector peak current	I_{CM}	2,0	2,0	2,0	A
Collector current	I_C	1,5	1,5	1,5	A
Base current	I_B	0,2	0,2	0,2	A
Junction temperature	T_j	150	150	150	°C
Storage temperature range	T_{stg}	-55 to +125			°C
Total power dissipation ($T_{case} \leq 25^\circ\text{C}$)	P_{tot}	12,5	12,5	12,5	W

Thermal resistance

Junction to ambient air	R_{thJA}	≤110	≤110	≤110	K/W
Junction to case bottom	$R_{thJC}^1)$	≤10	≤10	≤10	K/W

Static characteristics ($T_{amb} = 25\text{ }^{\circ}\text{C}$)

The transistors BD 135, BD 137, and BD 139 are grouped in accordance with the DC current gain h_{FE} , and marked by numerals of the German DIN standard.

h_{FE} group	6	10	16	
Type	BD 135 BD 137 BD 139	BD 135 BD 137 BD 139	BD 135 – –	BD 135 BD 137 BD 139
I_C (mA)	h_{FE} I_C/I_B	h_{FE} I_C/I_B	h_{FE} I_C/I_B	V_{BE} (V)
5	> 25	> 25	> 25	–
150	63 (40 to 100)	100 (63 to 160)	160 (100 to 250)	–
500	> 25	> 25	> 25	1.2

Static characteristics ($T_{amb} = 25\text{ }^{\circ}\text{C}$)

		BD 135	BD 137	BD 139	
Collector-emitter saturation voltage ($I_C = 500\text{ mA}$; $I_B = 50\text{ mA}$)	V_{CEsat}	< 0.5	< 0.5	< 0.5	V
Collector cutoff current ($V_{CB} = 30\text{ V}$)	I_{CBO}	< 100	< 100	< 100	nA
Collector cutoff current ($V_{CB} = 30\text{ V}$; $T_{amb} = 125\text{ }^{\circ}\text{C}$)	I_{CBO}	≤ 10	≤ 10	≤ 10	μA
Emitter cutoff current ($V_{EB} = 5\text{ V}$)	I_{EBO}	≤ 10	≤ 10	≤ 10	μA
Collector-emitter breakdown voltage ($I_{CEO} = 50\text{ mA}$)	$V_{(BR)CEO}$	> 45	> 60	> 80	V
Condition for matching pairs ($I_C = 150\text{ mA}$; $V_{CE} = 2\text{ V}$)	$\frac{h_{FE1}}{h_{FE2}}$	≤ 1.41	≤ 1.41	≤ 1.41	–

Dynamic characteristics ($T_{amb} = 25\text{ }^{\circ}\text{C}$)

Transition frequency ($I_C = 50\text{ mA}$; $V_{CE} = 10\text{ V}$; $f = 100\text{ MHz}$)	f_T	> 50	> 50	> 50	MHz
--	-------	------	------	------	-----

Total perm. power dissipation versus temperature

$P_{tot} = f(T)$; R_{th} = parameter
 BD 135, BD 137, BD 139

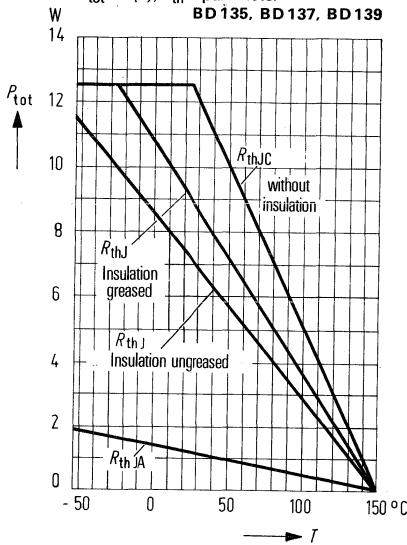

Permissible pulse load

$r_{thJC} = f(t)$; $v =$ parameter
 BD 135, BD 137, BD 139

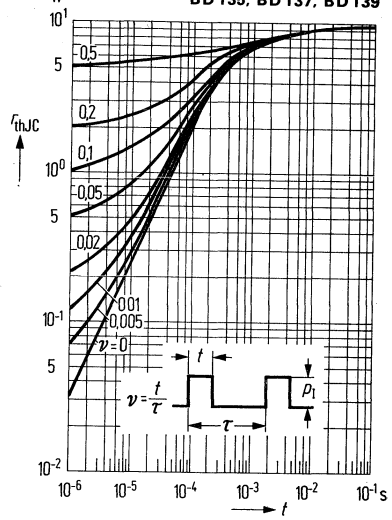

Permissible operating range

$I_C = f(V_{CE})$; $T_{case} = 60^\circ C$; $v = 0$
 BD 135, BD 137, BD 139

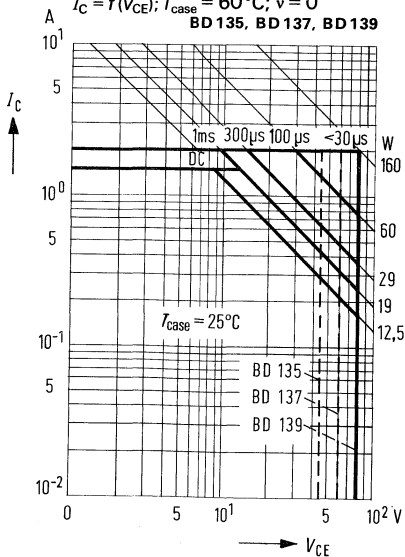

Collector current $I_C = f(V_{BE})$

$V_{CE} = 2V$; $T_{amb} =$ parameter
 (common emitter configuration)
 BD 135, BD 137, BD 139

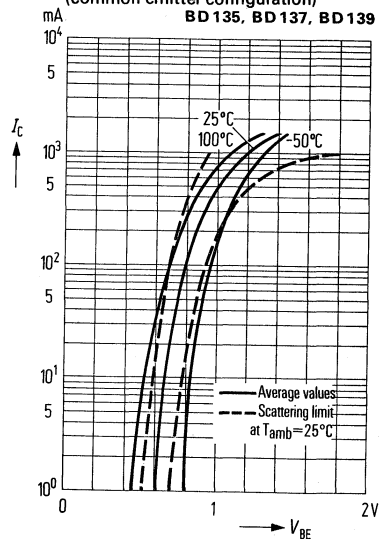

DC current gain $h_{FE} = f(I_C)$
 $V_{CE} = 2\text{ V}; T_{amb} = \text{parameter}$
BD 135-10, BD 137-10, BD 139-10

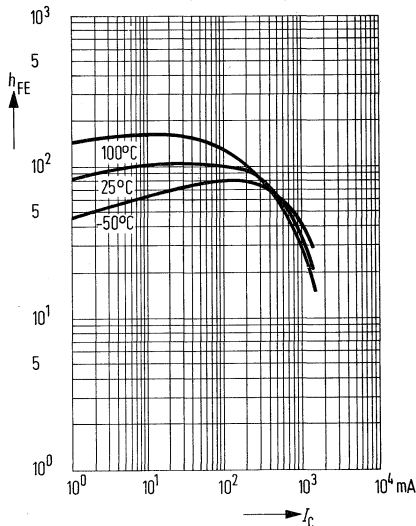

Collector cutoff current versus temperature
 $I_{CBO} = f(T_{amb})$
BD 135, BD 137, BD 139

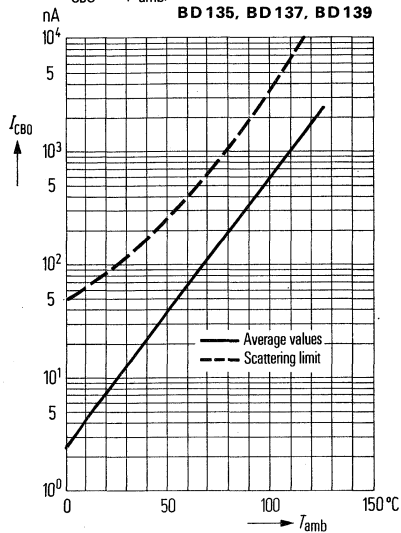

Collector-emitter saturation voltage
 $V_{CEsat} = f(I_C)$
 $h_{FE} = 10; T_{amb} = \text{parameter}$
 (common emitter configuration)
BD 135, BD 137, BD 139

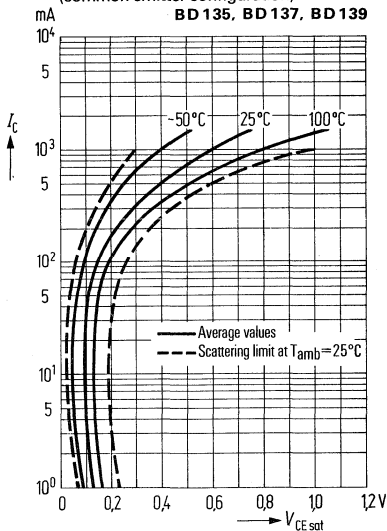

Base-emitter saturation voltage
 $V_{BEsat} = f(I_C)$
 $h_{FE} = 10; T_{amb} = \text{parameter}$
 (common emitter configuration)
BD 135, BD 137, BD 139

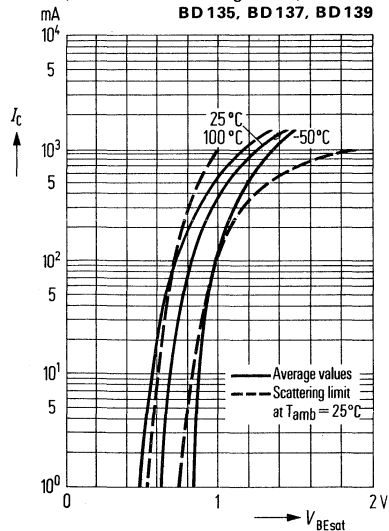

Output characteristics $I_C = f(V_{CE})$
 $I_B = \text{parameter}$

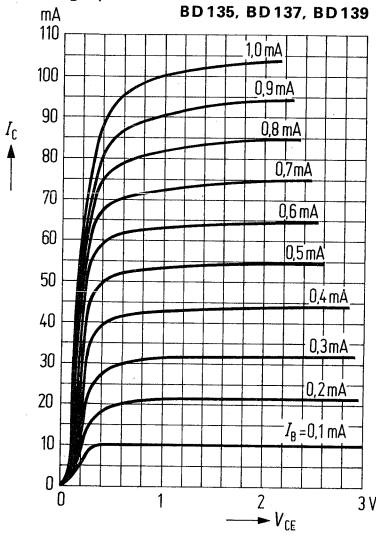

Output characteristics $I_C = f(V_{CE})$
 $I_B = \text{parameter}$

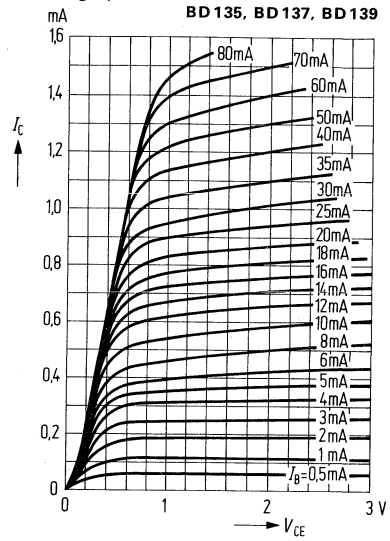

Output characteristics $I_C = f(V_{CE})$
 $I_B = \text{parameter}$

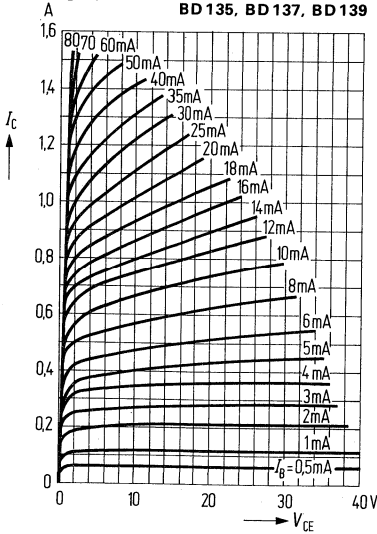

Transition frequency $f_T = f(I_C)$
 $(V_{CE} = 10 \text{ V})$

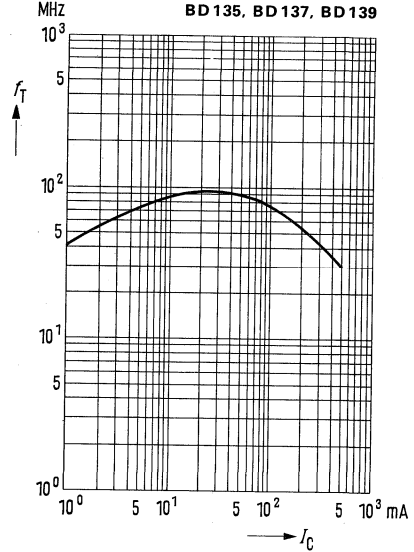

For AF driver and output stages of medium performance

BD 136, BD 138, and BD 140 are epitaxial PNP silicon planar transistors in TO 126 plastic package (12 A 3 DIN 41869, sheet 4). The collector is electrically connected to the metallic mounting area. Together with BD 135, BD 137, and BD 139 as complementary pairs the transistors BD 136, BD 138, and BD 140 are designed for use in driver stages of high performance AF amplifiers.

Type	Ordering code
BD 136	Q62702-D107
BD 136-6	Q62702-D107-V1
BD 136-10	Q62702-D107-V2
BD 136-16	Q62702-D107-V3
BD 136 paired	Q62702-D107-P
BD 138	Q62702-D109
BD 138-6	Q62702-D109-V1
BD 138-10	Q62702-D109-V2
BD 138 paired	Q62702-D109-P
BD 140	Q62702-D111
BD 140-6	Q62702-D111-V1
BD 140-10	Q62702-D111-V2
BD 140 paired	Q62702-D111-P
BD 136/135 compl. paired	Q62702-D139-S1
BD 138/137 compl. paired	Q62702-D140-S1
BD 140/139 compl. paired	Q62702-D141-S1

Type	Ordering code
Mica washer	Q62902-B62
Spring washer	Q62902-B63
A 3 DIN 137	

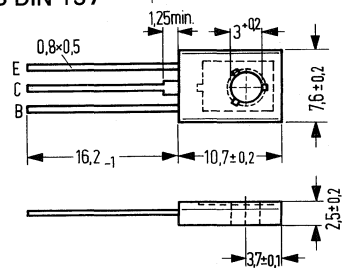

Approx. weight 0.5 g Dimensions in mm

Transistor fixing with M 3 screw. Starting torque max 0.8 Nm. Below the screw head, a washer or spring washer should be used.
1) If a 50 μ mica washer (ungreased) is used, the thermal resistance increases by 8 K/W and in case of a greased one by 4 K/W.

Maximum ratings

		BD 136	BD 138	BD 140	
Collector-emitter voltage ($R_{BE} \leq 1 \text{ k}\Omega$)	$-V_{CER}$	-	-	100	V
Collector-base voltage	$-V_{CBO}$	45	60	-	V
Collector-emitter voltage	$-V_{CEO}$	45	60	80	V
Emitter-base voltage	$-V_{EBO}$	5	5	5	V
Collector peak current	$-I_{CM}$	2.0	2.0	2.0	A
Collector current	$-I_C$	1,5	1,5	1,5	A
Base current	$-I_B$	0.2	0.2	0.2	A
Junction temperature	T_j	150	150	150	°C
Storage temperature range	T_{stg}	-55 to +125			°C
Total power dissipation ($T_{case} \leq 25^\circ\text{C}$)	P_{tot}	12.5	12.5	12.5	W

Thermal resistance

		BD 136	BD 138	BD 140	
Junction to ambient air	R_{thJA}	≤ 110	≤ 110	≤ 110	K/W
Junction to case bottom	$R_{thJC}^1)$	≤ 10	≤ 10	≤ 10	K/W

Static characteristics ($T_{amb} = 25^{\circ}\text{C}$)

The transistors BD 136, BD 138, and BD 140 are grouped according to the DC current gain h_{FE} and marked by numerals of the German DIN standard.

h_{FE} group	6	10	16	
Type	BD 136 BD 138 BD 140	BD 136 BD 138 BD 140	BD 136 – –	BD 136 BD 138 BD 140
$-I_C$ (mA)	h_{FE} I_C/I_B	h_{FE} I_C/I_B	h_{FE} I_C/I_B	$-V_{BE}$ (V)
5	>25	>25	>25	–
150	63 (40 to 100)	100 (63 to 160)	160 (100 to 250)	–
500	>25	>25	>25	1.2

Static characteristics ($T_{amb} = 25^{\circ}\text{C}$)

Collector-emitter-saturation
voltage ($-I_C = 500$ mA;
 $-I_B = 500$ mA)

Collector cutoff current
($-V_{CB} = 30$ V)

Collector cutoff current
($-V_{CB} = 30$ V; $T_{amb} = 125^{\circ}\text{C}$)

Emitter cutoff current
($-V_{EB} = 5$ V)

Collector-emitter breakdown
voltage ($-I_{CEO} = 50$ mA)

Condition for matching pairs
($-I_C = 150$ mA; $-V_{CE} = 2$ V)

Dynamic characteristics ($T_{amb} = 25^{\circ}\text{C}$)

Transition frequency ($-I_C = 50$ mA;
 $-V_{CE} = 10$ V; $f = 100$ MHz)

	BD 136	BD 138	BD 140	
$-V_{CEsat}$	<0.5	>0.5	<0.5	V
$-I_{CBO}$	<100	<100	<100	nA
$-I_{CBO}$	≤ 10	≤ 10	≤ 10	μA
$-I_{EBO}$	≤ 10	≤ 10	≤ 10	μA
$-V_{(BR)CEO}$	>45	>60	>80	V
$\frac{h_{FE1}}{h_{FE2}}$	≤ 1.41	≤ 1.41	≤ 1.41	–
f_T	>75	>75	>75	MHz

Total perm. power dissipation versus temperature
 $P_{tot} = f(T); R_{th} = \text{parameter}$
BD 136, BD 138, BD 140

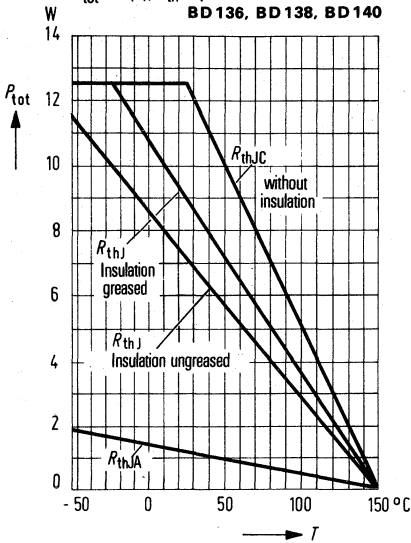

Permissible pulse load
 $r_{thJC} = f(t); v = \text{parameter}$
BD 136, BD 138, BD 140

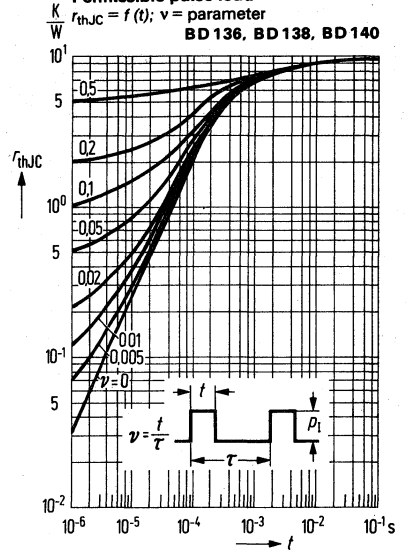

Permissible operating range
 $I_C = f(V_{CE}); (T_{case} = 60^\circ\text{C}); v = 0$
BD 136, BD 138, BD 140

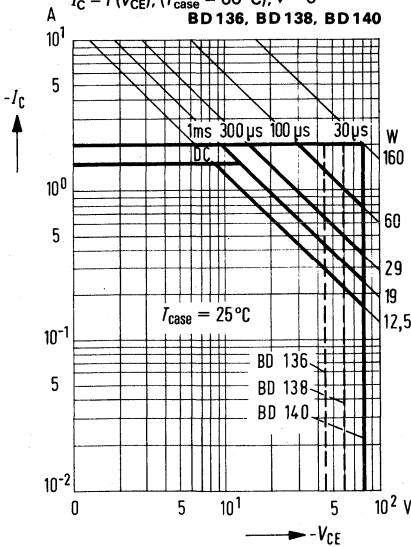

Collector current $I_C = f(V_{BE})$
 $V_{CE} = 2\text{ V}; T_{amb} = \text{parameter}$
 (common emitter configuration)
BD 136, BD 138, BD 140

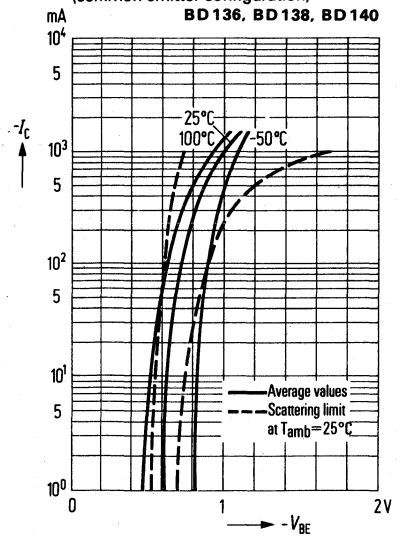

DC current gain $h_{FE} = f(I_C)$
 $V_{CE} = 2\text{ V}; T_{amb} = \text{parameter}$
BD 136-10, BD 138-10, BD 140-10

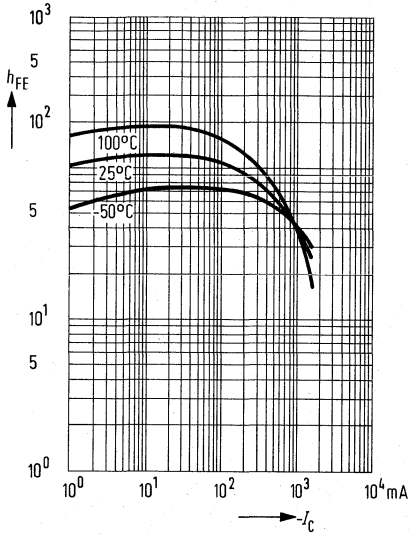

Collector cutoff current versus temperature
 $I_{CBO} = f(T_{amb})$
BD 136, BD 138, BD 140

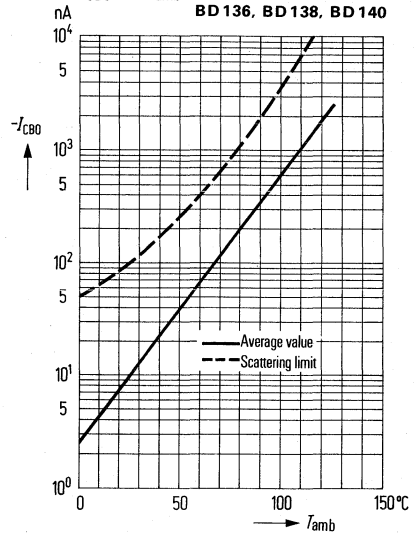

Collector-emitter saturation voltage
 $V_{CEsat} = f(I_C)$
 $h_{FE} = 10; T_{amb} = \text{parameter}$
 (common emitter configuration)
BD 136, BD 138, BD 140

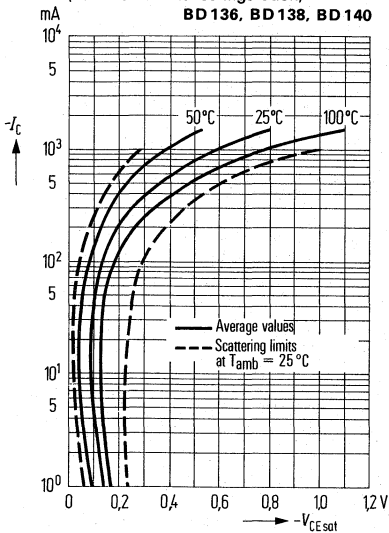

Base-emitter saturation voltage
 $V_{BEsat} = f(I_C)$
 $h_{FE} = 10; T_{amb} = \text{parameter}$
 (common emitter configuration)
BD 136, BD 138, BD 140

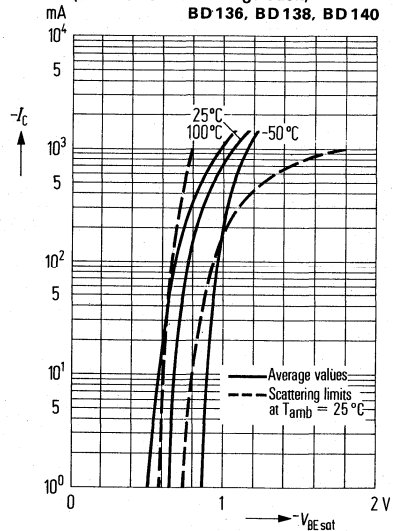

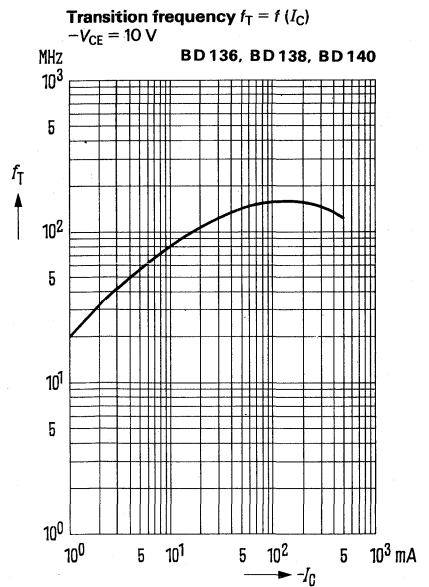
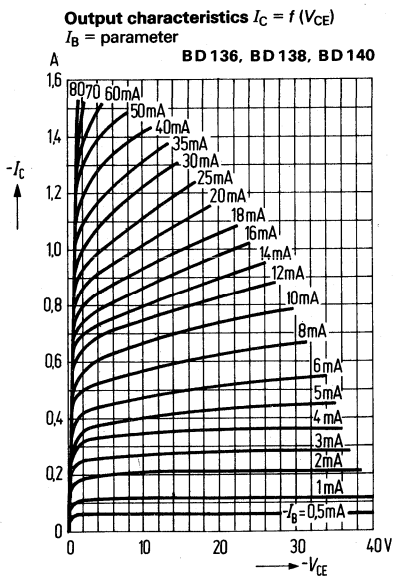
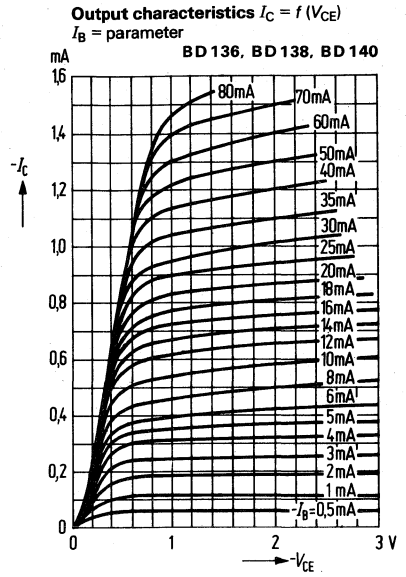
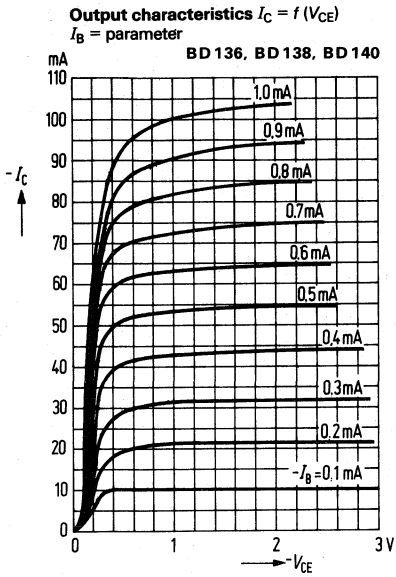

BD 287 and BD 288 are epitaxial planar transistors in TO 126 plastic package (12 A 3 DIN 41869, sheet 4). The collector is electrically connected to the metallic mounting area. The transistors are particularly designed for switching applications in flash devices.

Type	Ordering code
BD 287	Q62702-D900
BD 288	Q62702-D901
Spring washer A3 DIN 137	Q62902-B63
Mica washer	Q62902-B62

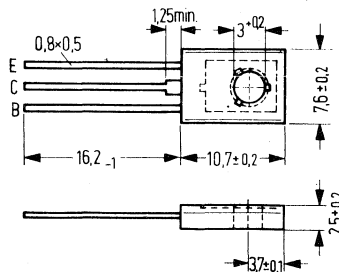

Approx. weight 0.5 g Dimensions in mm
 Transistor fixing with M3 screw. Starting torque max. 0.8 Nm. Washer or spring washer should be used.

Maximum ratings ($T_{amb} = 25^{\circ}\text{C}$)

Collector-emitter voltage	$-V_{CEO}$	25	45	V
Collector-emitter voltage	$-V_{CES}$	30	45	V
Collector-base voltage	$-V_{CBO}$	30	45	V
Emitter-base voltage	$-V_{EBO}$	5	5	V
Collector current	$-I_C$	12	12	A
Collector peak current ($t \leq 10$ ms)	$-I_{CM}$	15	15	A
Emitter peak current	I_{EM}	15	15	A
Base current	$-I_B$	2	2	A
Base peak current	$-I_{BM}$	5	5	A
Junction temperature	T_j	150	150	$^{\circ}\text{C}$
Storage temperature range	T_{stg}	-50 to +150		$^{\circ}\text{C}$
Total power dissipation ($T_{case} = 25^{\circ}\text{C}$)	P_{tot}	36	36	W

	BD 287	BD 288	
$-V_{CEO}$	25	45	V
$-V_{CES}$	30	45	V
$-V_{CBO}$	30	45	V
$-V_{EBO}$	5	5	V
$-I_C$	12	12	A
$-I_{CM}$	15	15	A
I_{EM}	15	15	A
$-I_B$	2	2	A
$-I_{BM}$	5	5	A
T_j	150	150	$^{\circ}\text{C}$
T_{stg}	-50 to +150		$^{\circ}\text{C}$
P_{tot}	36	36	W

Thermal resistance

Junction to ambient air	R_{thJA}	≤ 100	≤ 100	K/W
Junction to mounting area	R_{thJC}	$\leq 3,5$	$\leq 3,5$	K/W

Static characteristics ($T_{amb} = 25^{\circ}\text{C}$)

Collector cutoff current

($-V_{CE} = 30\text{ V}$)

	BD 287	BD 288	
$-I_{CES}$	≤ 1	≤ 1	μA
Collector cutoff current ($-V_{CE} = 30\text{ V}; T_{amb} = 125^{\circ}\text{C}$)	≤ 100	≤ 100	μA
DC current gain ($-I_C = 12\text{ A}; -V_{CE} = 0.7\text{ V}$)	≥ 25	≥ 25	-
DC current gain ($-I_C = 0.1\text{ A}; -V_{CE} = 0.7\text{ V}$)	200	200	-
Base-emitter forward voltage ($-I_C = 12\text{ A}; -V_{CE} = 0.7\text{ V}$)	< 1.7	< 1.7	V
Base-emitter forward voltage ($-I_C = 0.1\text{ A}; -V_{CE} = 0.7\text{ V}$)	< 0.8	< 0.8	V

Collector cutoff current

($-V_{CE} = 30\text{ V}; T_{amb} = 125^{\circ}\text{C}$)

DC current gain

($-I_C = 12\text{ A}; -V_{CE} = 0.7\text{ V}$)

DC current gain

($-I_C = 0.1\text{ A}; -V_{CE} = 0.7\text{ V}$)

Base-emitter forward voltage

($-I_C = 12\text{ A}; -V_{CE} = 0.7\text{ V}$)

Base-emitter forward voltage

($-I_C = 0.1\text{ A}; -V_{CE} = 0.7\text{ V}$)

Dynamic characteristics ($T_{amb} = 25^{\circ}\text{C}$)

Transition frequency

($-V_{CE} = 10\text{ V}; -I_C = 0.2\text{ A}$)

Collector-base capacitance

($-V_{CB} = 10\text{ V}$)

Switching times

($-I_C = 2\text{ A}; I_{B1}$ approx. I_{B2} approx. 0.2 A)

f_T	≥ 50	≥ 50	MHz
C_{CB}	130	130	pF
t_{on}	< 0.5	< 0.5	μs
t_{off}	< 2	< 2	μs

Total perm. power dissipation versus temperature

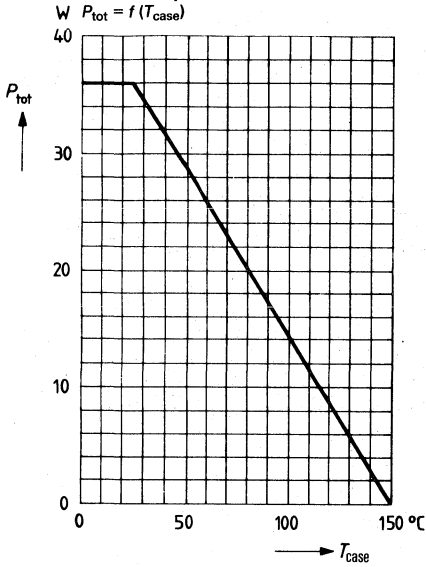

DC current gain $h_{FE} = f(I_C)$

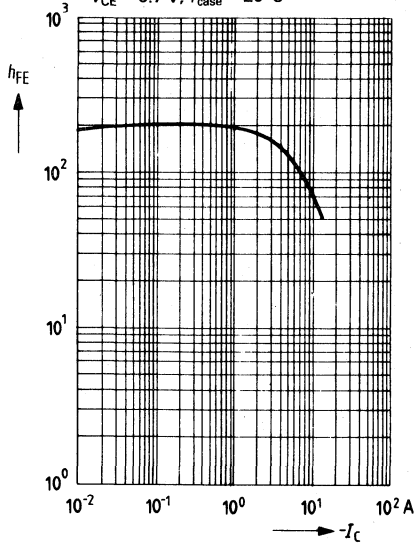

Collector cutoff current versus temperature $I_{CES} = f(T_{\text{case}})$

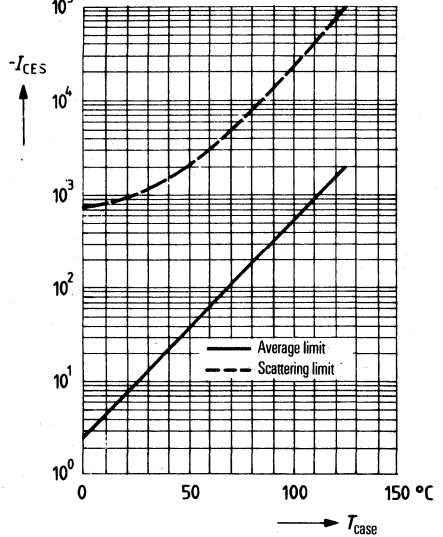

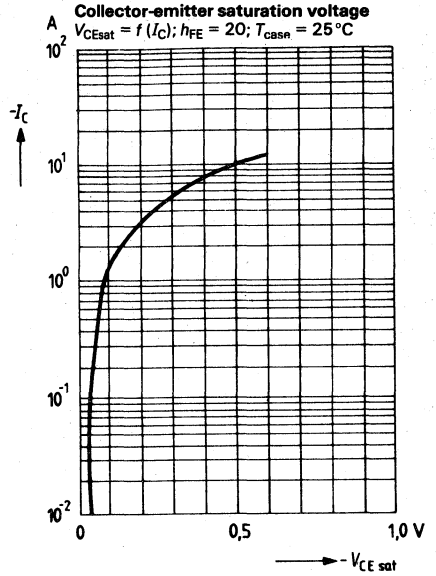
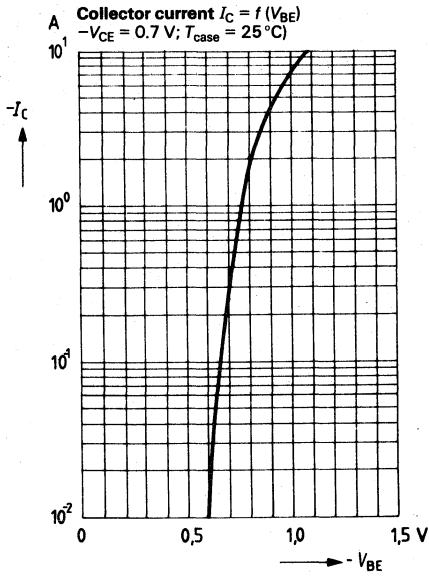

BD 329 is an epitaxial NPN silicon planar transistor in TO 126 plastic package (12 A 3 DIN 41 869, sheet 4). Together with its complementary transistor BD 330 it is particularly suitable for use in complementary output stages of medium performance (e.g. car radios).

Type	Ordering code
BD 329	Q62702-D394
BD 329/BD 330 paired	Q62702-D401
Spring washer A 3 DIN 137	Q62902-B63

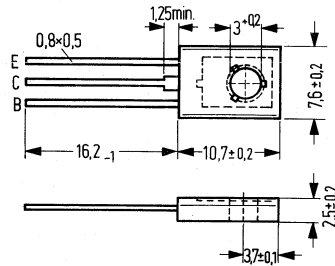

Approx. weight 0.5 g Dimensions in mm
 Transistor fixing with M3 screw
 Starting torque max. 0.8 Nm
 Washer or spring washer should be used.

Maximum ratings

Collector-emitter voltage
 Collector-emitter voltage
 Emitter-base voltage
 Collector current
 Emitter current
 Base current
 Junction temperature
 Storage temperature range
 Total power dissipation ($T_{amb} = 25^\circ\text{C}$)

V_{CES}	32	V
V_{CEO}	20	V
V_{EBO}	5	V
I_C	3	A
I_E	3	A
I_B	1	A
T_j	150	$^\circ\text{C}$
T_{stg}	-55 to +150	$^\circ\text{C}$
P_{tot}	15	W

Thermal resistance

Junction to ambient air
 Junction to mounting area

R_{thJU}	≤ 100	K/W
R_{thJC}	≤ 7	K/W

Static characteristics ($T_{amb} = 25^{\circ}\text{C}$)

Collector-emitter saturation voltage

($I_C = 2\text{ A}$; $I_B = 200\text{ mA}$)

Collector cutoff current

($V_{CB} = 32\text{ V}$)

Collector cutoff current

($V_{CB} = 32\text{ V}$; $T_j = 150^{\circ}\text{C}$)

Emitter cutoff current

($V_{EB} = 5\text{ V}$)

Base-emitter voltage

($V_{CE} = 10\text{ V}$; $I_C = 5\text{ mA}$)

($V_{CE} = 1\text{ V}$; $I_C = 2\text{ A}$)

DC current gain

$V_{CE} = 10\text{ V}$; $I_C = 5\text{ mA}$

$V_{CE} = 1\text{ V}$; $I_C = 0.5\text{ A}$

$V_{CE} = 1\text{ V}$; $I_C = 2\text{ A}$

V_{CEsat}	≤ 0.5	V
I_{CBO}	≤ 10	μA
I_{CBO}	≤ 1	mA
I_{EBO}	≤ 10	μA
V_{BE}	0.6	V
V_{BE}	≤ 1.2	V
h_{FE}	> 50	-
h_{FE}	85 to 375	-
h_{FE}	> 40	-

Dynamic characteristics ($T_{amb} = 25^{\circ}\text{C}$)

Transition frequency

($V_{CE} = 5\text{ V}$; $I_C = 50\text{ mA}$)

f_T	130	MHz
-------	-----	-----

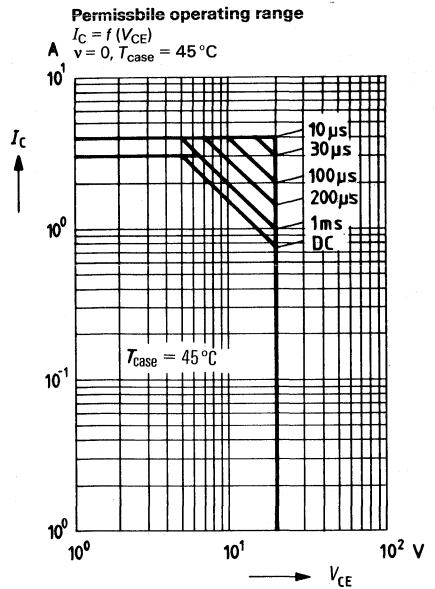
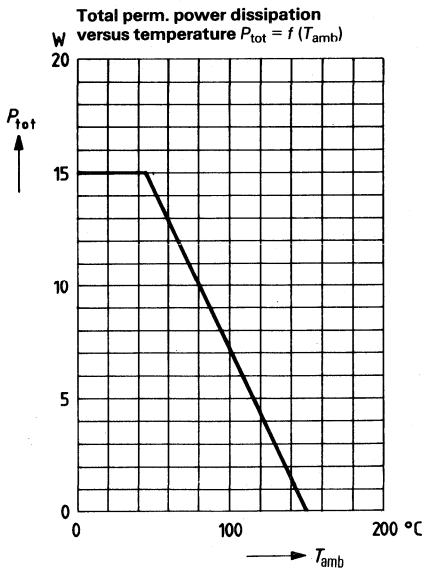

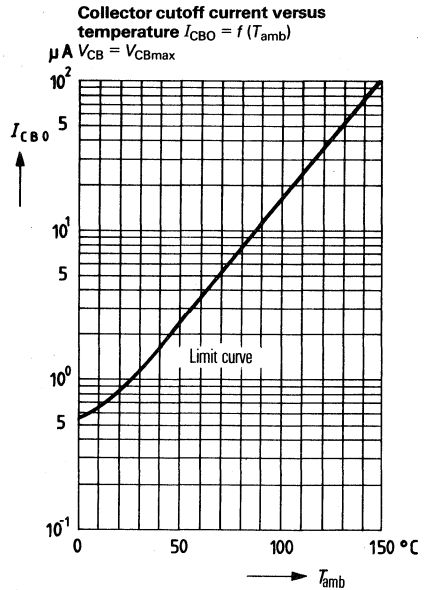
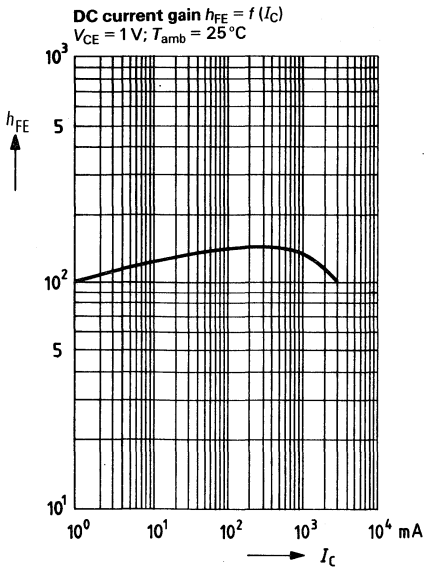
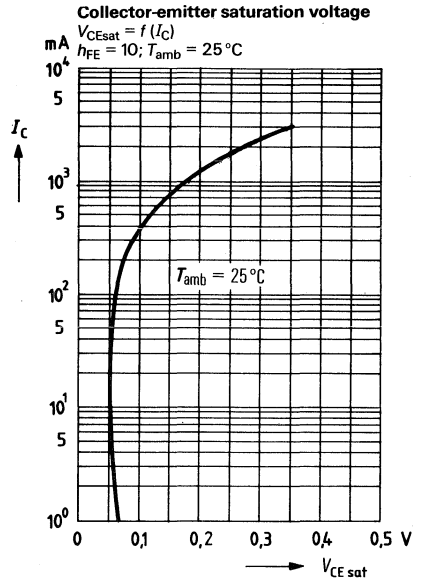
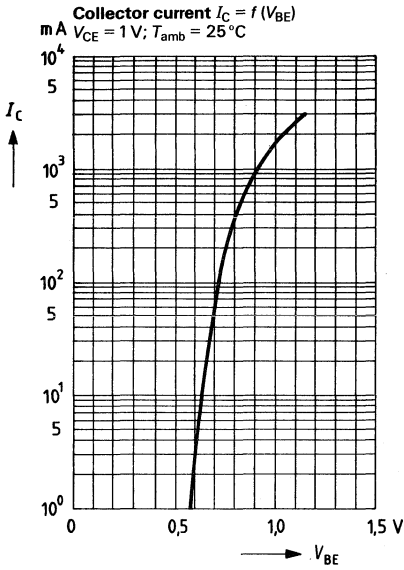

BD 330 is an epitaxial PNP silicon planar transistor in TO 126 plastic package (12 A 3 DIN 41 869, sheet 4). Together with its complementary transistor BD 329 it is particularly suitable for use in complementary output stages of medium performance (e.g. car radios).

Type	Ordering code
BD 330	Q62702-D395
BD 330/BD 329 paired	Q62702-D401
Spring washer A 3 DIN 137	Q62902-B63

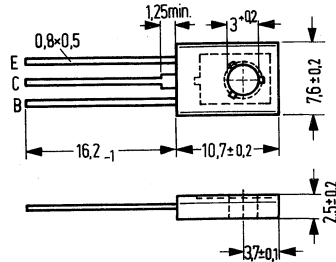

Approx. weight 0.5 g

Turning torque of the M3 screw used for mounting: 0.8 Nm, washer or spring washer should be used.

Maximum ratings

Collector-emitter voltage	-V _{CES}	32	V
Collector-emitter voltage	-V _{CEO}	20	V
Emitter-base voltage	-V _{EBO}	5	V
Collector current	-I _C	3	A
Emitter current	-I _E	3	A
Base current	-I _B	1	A
Junction temperature	T _j	150	°C
Storage temperature range	T _{stg}	-55 to +150	°C
Total power dissipation (T _{amb} = 25 °C)	P _{tot}	15	W

Thermal resistance

Junction to ambient air	R _{thJA}	≤100	K/W
Junction to mounting area	R _{thJC}	≤7	K/W

Static characteristics ($T_{amb} = 25^{\circ}\text{C}$)

Collector-emitter saturation voltage

($-I_C = 2\text{ A}$; $-I_B = 200\text{ mA}$)

Collector cutoff current

($-V_{CB} = 32\text{ V}$)

Collector cutoff current

($-V_{CB} = 32\text{ V}$; $T_j = 150^{\circ}\text{C}$)

Emitter cutoff current

($-V_{EB} = 5\text{ V}$)

Base-emitter voltage

($-V_{CE} = 10\text{ V}$; $-I_C = 5\text{ mA}$)

($-V_{CE} = 1\text{ V}$; $-I_C = 2\text{ A}$)

DC current gain

$-V_{CE} = 10\text{ V}$; $-I_C = 5\text{ mA}$

$-V_{CE} = 1\text{ V}$; $-I_C = 0.5\text{ A}$

$-V_{CE} = 1\text{ V}$; $-I_C = 2\text{ A}$

$-V_{CEsat}$	≤ 0.5	V
$-I_{CBO}$	≤ 10	μA
$-I_{CBO}$	≤ 1	mA
$-I_{EBO}$	≤ 10	μA
$-V_{BE}$	0.6	V
$-V_{BE}$	≤ 1.2	V
h_{FE}	> 50	-
h_{FE}	85 to 375	-
h_{FE}	> 40	-

Dynamic characteristics ($T_{amb} = 25^{\circ}\text{C}$)

Transition frequency

($-V_{CE} = 5\text{ V}$; $-I_C = 50\text{ mA}$)

f_T	100	MHz
-------	-----	-----

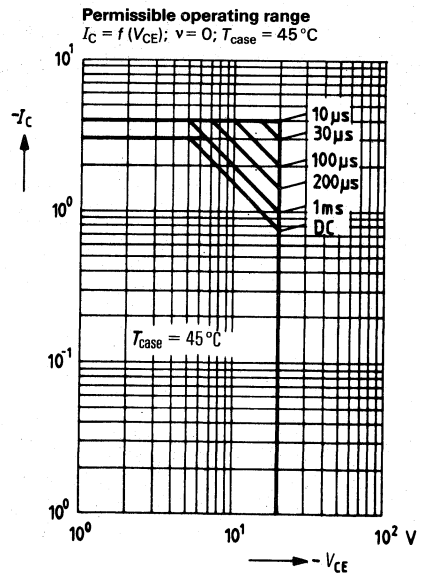
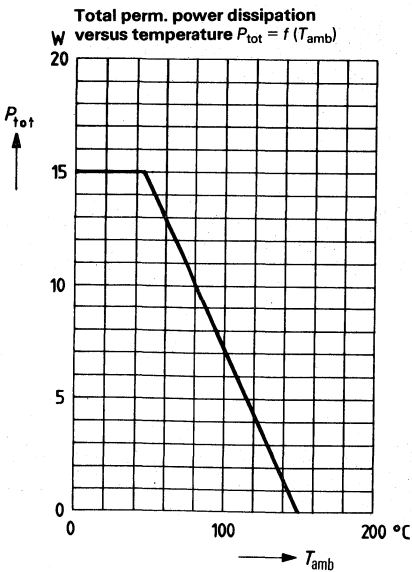

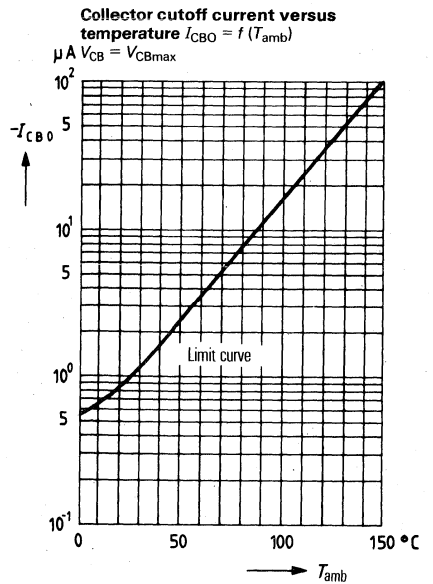
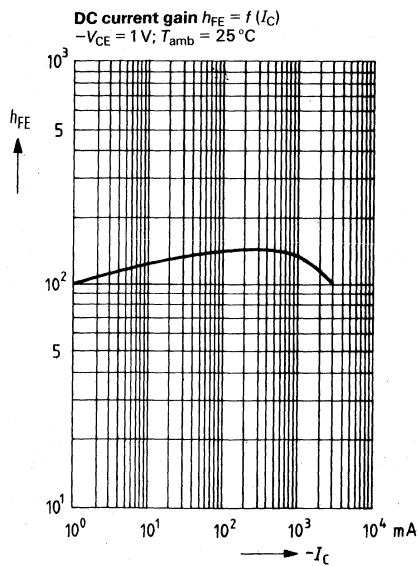
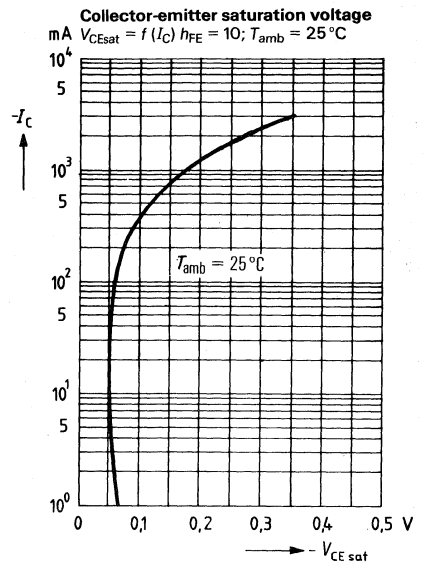
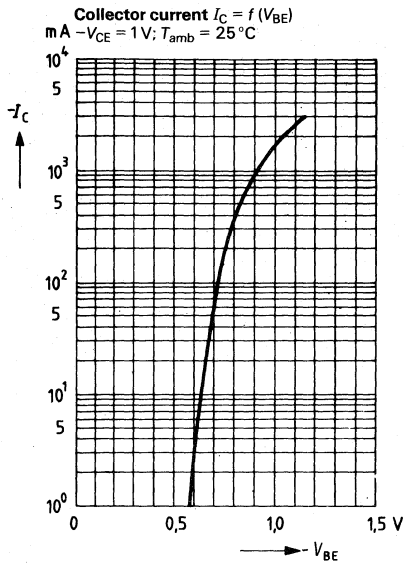

BD 424 is an epitaxial NPN silicon planar transistor in a plastic package similar to TO 202. It is particularly intended for use as driver transistor in horizontal deflection stages of TV sets as well as for universal applications at higher reverse voltages.

Type	Ordering code
BD 424	Q62702-D1068

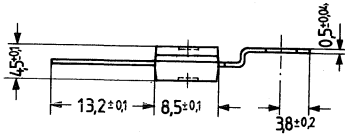

Available upon request also with bent down fixing plate.

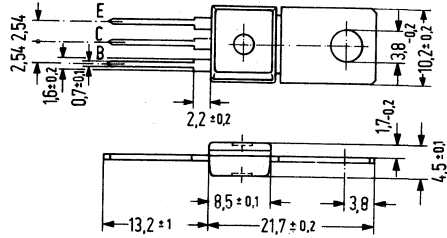

Approx. weight 15 g Dimensions in mm

Maximum ratings ($T_U = 25\text{C}$)

- Collector-emitter voltage
- Collector-emitter voltage
- Emitter-base voltage
- Collector current
- Collector peak current
- Base current
- Junction temperature
- Storage temperature range
- Total power dissipation ($T_{\text{case}} \leq 100^\circ\text{C}$)

V_{CEO}	100	V
V_{CES}	160	V
V_{EBO}	5	V
I_{C}	0.8	A
I_{CM}	1	A
I_{B}	100	mA
T_{j}	150	$^\circ\text{C}$
T_{stg}	-55 to +125	$^\circ\text{C}$
P_{tot}	2.5	W

Thermal resistance

Junction to ambient air	R_{thJA}	<70	K/W
Junction to case	R_{thJC}	<20	K/W

Static characteristics ($T_{\text{amb}} = 25^{\circ}\text{C}$)

Collector cutoff current ($V_{\text{CB}} = 140\text{ V}$)	I_{CBO}	< 100	nA
Collector cutoff current ($V_{\text{CB}} = 140\text{ V}$; $T_{\text{amb}} = 125^{\circ}\text{C}$)	I_{CBO}	< 10	μA
Emitter cutoff current ($V_{\text{EB}} = 5\text{ V}$)	I_{EBO}	< 10	μA
Collector-emitter breakdown voltage ($I_{\text{C}} = 50\text{ mA}$)	$V_{(\text{BR})\text{CEO}}$	> 100	V
Collector-emitter breakdown voltage ($I_{\text{C}} = 100\ \mu\text{A}$)	$V_{(\text{BR})\text{CES}}$	> 160	V
Emitter-base breakdown voltage ($I_{\text{E}} = 1\ \mu\text{A}$)	$V_{(\text{BR})\text{EBO}}$	> 5	V
DC current gain ($I_{\text{C}} = 100\text{ mA}$; $V_{\text{CE}} = 1\text{ V}$)	h_{FE}	> 40	–
($I_{\text{C}} = 200\text{ mA}$; $V_{\text{CE}} = 1\text{ V}$)	h_{FE}	> 20	–
Base-emitter forward voltage ($I_{\text{C}} = 200\text{ mA}$; $V_{\text{CE}} = 1\text{ V}$)	V_{BE}	< 1.3	V
Collector-emitter saturation voltage ($I_{\text{C}} = 300\text{ mA}$; $I_{\text{B}} = 30\text{ mA}$)	V_{CEsat}	< 1	V
Base-emitter saturation voltage ($I_{\text{C}} = 300\text{ mA}$; $I_{\text{B}} = 30\text{ mA}$)	V_{BEsat}	< 1.4	V

Dynamic characteristics ($T_{\text{amb}} = 25^{\circ}\text{C}$)

Transition frequency ($I_{\text{C}} = 10\text{ mA}$; $V_{\text{CE}} = 5\text{ V}$; $f = 20\text{ MHz}$)	f_{T}	100	MHz
--	----------------	-----	-----

Total perm. power dissipation versus temperature
 $P_{tot} = f(T)$

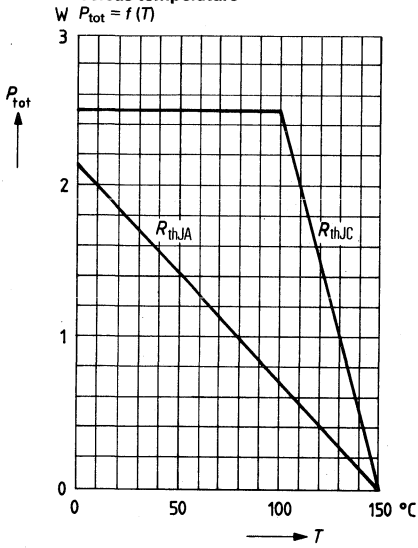

Permissible operating range

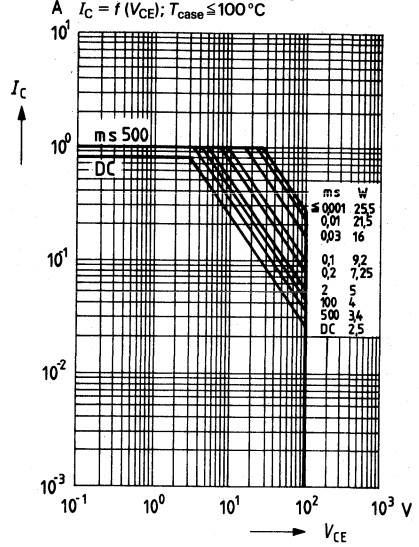

Permissible pulse load

$Z_{thJC} = f(\tau)$
 R_{thJC}

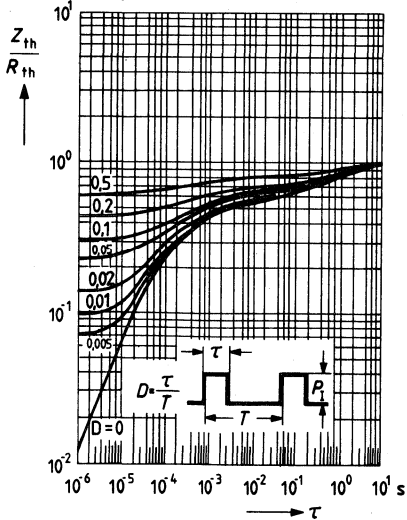

BD 429 is an epitaxial NPN silicon planar transistor in a plastic package similar to TO 202. Together with its complementary transistor BD 430 it is particularly suitable for use in complementary output stages of medium performance (e.g. car radios).

Type	Ordering code
BD 429	Q62702-D1069

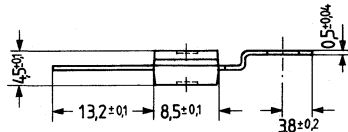

Available upon request also with bent fixing plate.

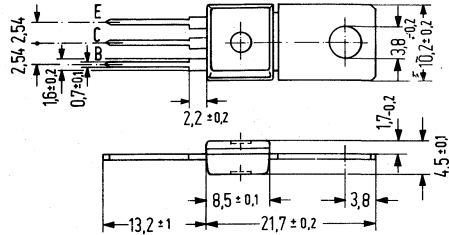

Approx. weight 15 g. Dimensions in mm

Maximum ratings

Collector-emitter voltage	V_{CES}	32	V
Collector-emitter voltage	V_{CEO}	20	V
Emitter-base voltage	V_{EBO}	5	V
Collector current	I_C	3	A
Emitter current	I_E	3	A
Base current	I_B	1	A
Junction temperature	T_j	150	°C
Storage temperature range	T_{stg}	-55 to +150	°C
Total power dissipation ($T_{case} = 25\text{°C}$)	P_{tot}	10	W
($T_{amb} = 25\text{°C}$)	P_{tot}	2	W

Thermal resistance

Junction to ambient air	R_{thJA}	$\leq 62,5$	K/W
Junction to mounting area	R_{thJC}	$\leq 12,5$	K/W

Static characteristics ($T_{\text{amb}} = 25^{\circ}\text{C}$)

Collector-emitter saturation voltage

($I_C = 2\text{ A}$; $I_B = 200\text{ mA}$) $V_{\text{CEsat}} \leq 0.5\text{ V}$

Collector cutoff current

($V_{\text{CB}} = 32\text{ V}$) $I_{\text{CBO}} \leq 10\text{ }\mu\text{A}$

Collector cutoff current

($V_{\text{CB}} = 32\text{ V}$; $T_j = 150^{\circ}\text{C}$) $I_{\text{CBO}} \leq 1\text{ mA}$

Emitter cutoff current

($V_{\text{EB}} = 5\text{ V}$) $I_{\text{EBO}} \leq 10\text{ }\mu\text{A}$

Base-emitter voltage

($V_{\text{CE}} = 10\text{ V}$; $I_C = 5\text{ mA}$) $V_{\text{BE}} = 0.6\text{ V}$ ($V_{\text{CE}} = 1\text{ V}$; $I_C = 2\text{ A}$) $V_{\text{BE}} \leq 1.2\text{ V}$

DC current gain

 $V_{\text{CE}} = 10\text{ V}$; $I_C = 5\text{ mA}$ $h_{\text{FE}} > 50$ $V_{\text{CE}} = 1\text{ V}$; $I_C = 0.5\text{ A}$ $h_{\text{FE}} = 85\text{ to }375$ $V_{\text{CE}} = 1\text{ V}$; $I_C = 2\text{ A}$ $h_{\text{FE}} > 40$ **Dynamic characteristics** ($T_{\text{amb}} = 25^{\circ}\text{C}$)

Transition frequency

($V_{\text{CE}} = 5\text{ V}$; $I_C = 50\text{ mA}$) $f_T = 130\text{ MHz}$

Total perm. power dissipation versus temperature

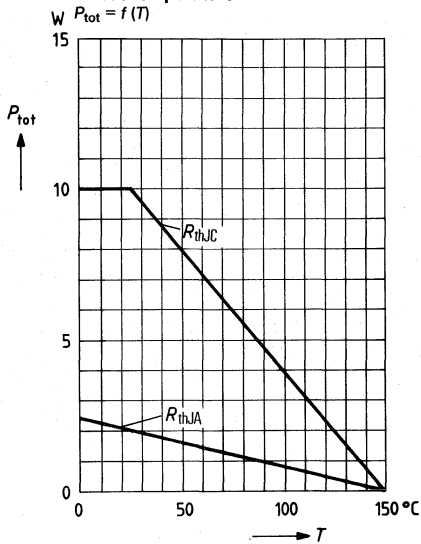

Permissible operating range

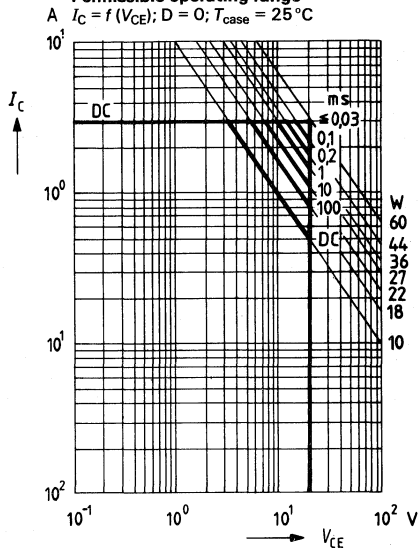

Permissible pulse load

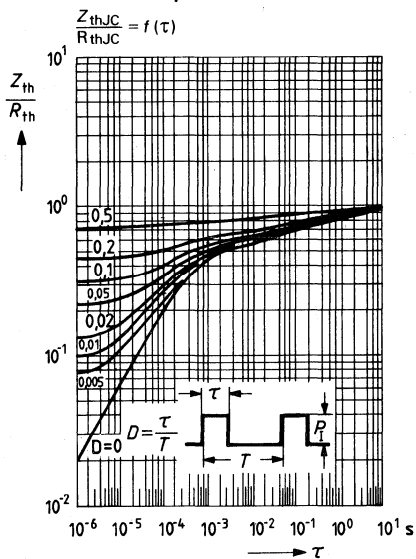

DC current gain $h_{FE} = f(I_C)$

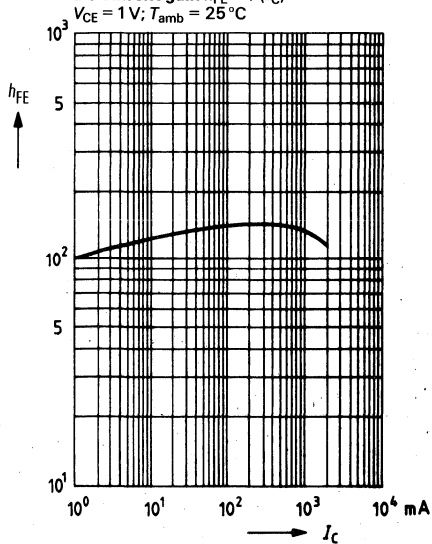

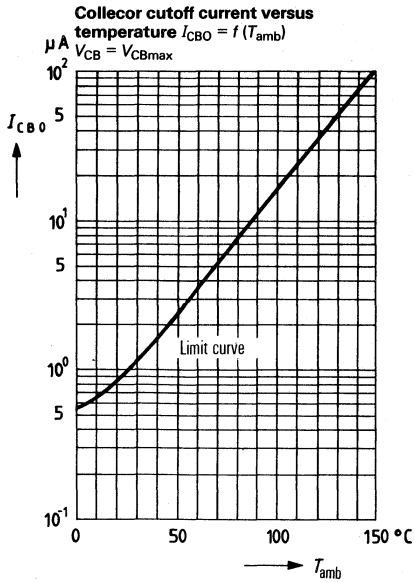
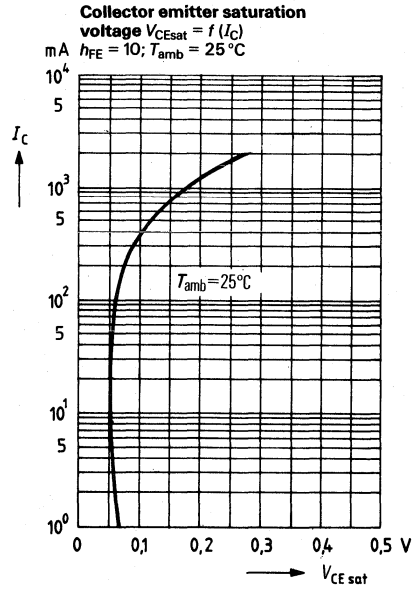
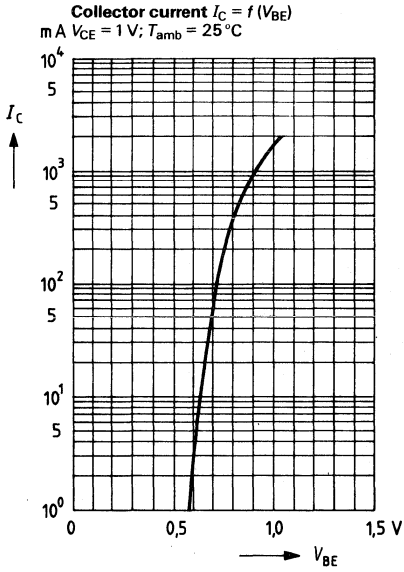

BD 430 is an epitaxial PNP silicon planar transistor in a plastic package similar to TO 202. Together with its complementary transistor BD 429 it is particularly suitable for use in complementary output stages of medium performance (e.g. car radios).

Type	Ordering code
BD 430	Q62702-D1070

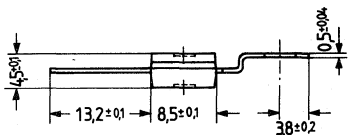

Available upon request also with bent fixing plate.

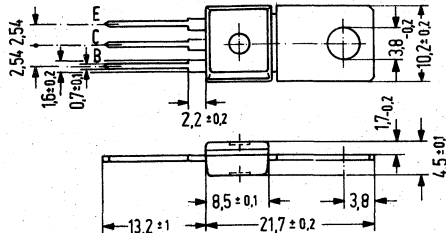

Approx. weight 15 g. Dimensions in mm

Maximum ratings

Collector-emitter voltage	$-V_{CES}$	32	V
Collector-emitter voltage	$-V_{CEO}$	20	V
Emitter-base voltage	$-V_{EBO}$	5	V
Collector current	$-I_C$	3	A
Emitter current	$-I_E$	3	A
Base current	$-I_B$	1	A
Junction temperature	T_j	150	°C
Storage temperature range	T_{stg}	-55 to +150	°C
Total power dissipation	P_{tot}	10	W
	P_{tot}	2	W

Thermal resistance

Junction to ambient air	R_{thJA}	$\leq 62,5$	K/W
Junction to mounting area	R_{thJC}	$\leq 12,5$	K/W

Static characteristics ($T_{\text{amb}} = 25^{\circ}\text{C}$)

Collector-emitter saturation voltage ($-I_C = 2\text{ A}$; $-I_B = 200\text{ mA}$)	$-V_{\text{CEsat}}$	≤ 0.5	V
Collector cutoff current ($-V_{\text{CB}} = 32\text{ V}$)	$-I_{\text{CBO}}$	≤ 10	μA
Collector cutoff current ($-V_{\text{CB}} = 32\text{ V}$; $T_j = 150^{\circ}\text{C}$)	$-I_{\text{CBO}}$	≤ 1	mA
Emitter cutoff current ($-V_{\text{EB}} = 5\text{ V}$)	$-I_{\text{EBO}}$	≤ 10	μA
Base-emitter voltage ($-V_{\text{CB}} = 10\text{ V}$; $-I_C = 5\text{ mA}$)	$-V_{\text{BE}}$	0.6	V
($-V_{\text{CB}} = 1\text{ V}$; $-I_C = 2\text{ A}$)	$-V_{\text{BE}}$	≤ 1.2	V
DC current gain			
$-V_{\text{CE}} = 10\text{ V}$; $I_C = 5\text{ mA}$	h_{FE}	> 50	-
$-V_{\text{CE}} = 1\text{ V}$; $I_C = 0.5\text{ A}$	h_{FE}	85 to 375	-
$-V_{\text{CE}} = 1\text{ V}$; $I_C = 2\text{ A}$	h_{FE}	> 40	-

Dynamic characteristics ($T_{\text{amb}} = 25^{\circ}\text{C}$)

Transition frequency ($-V_{\text{CE}} = 5\text{ V}$; $-I_C = 50\text{ mA}$)	f_T	100	MHz
---	-------	-----	-----

Total perm. power dissipation versus temperature

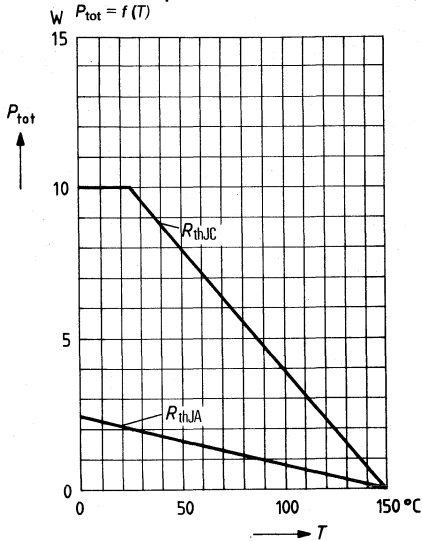

Permissible operating range $I_C = f(V_{CE})$
 $D = 0; T_{case} = 25^\circ C$

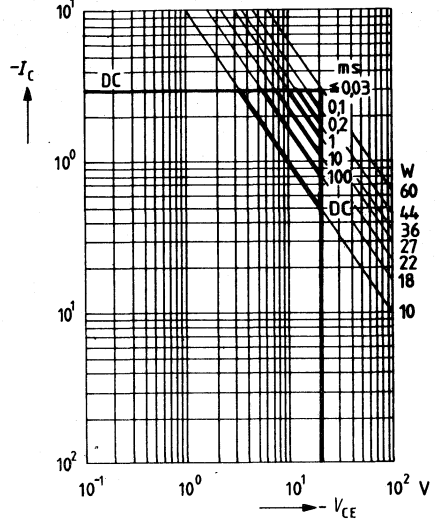

Permissible pulse load

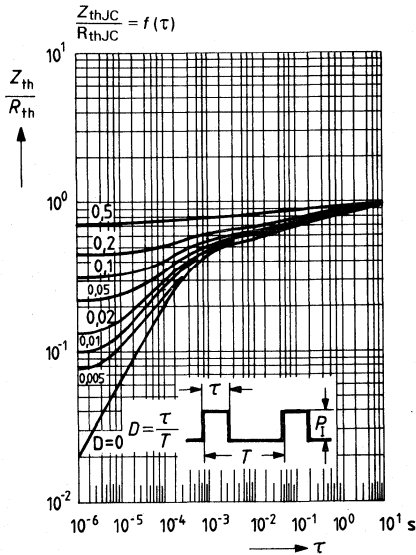

DC current gain $h_{FE} = f(I_C)$
 $-V_{CE} = 1 V, T_{amb} = 25^\circ C$

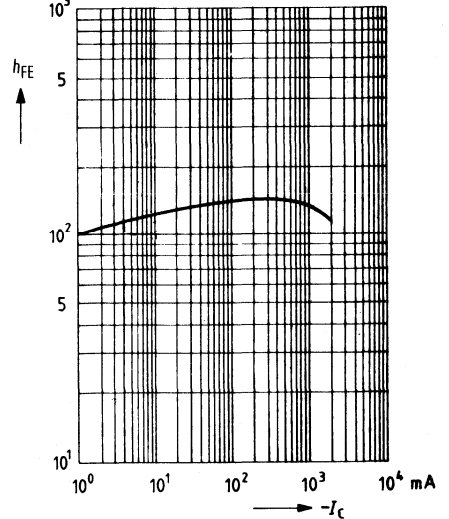

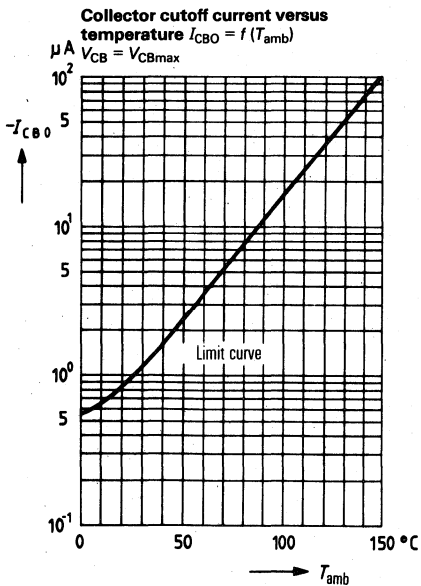
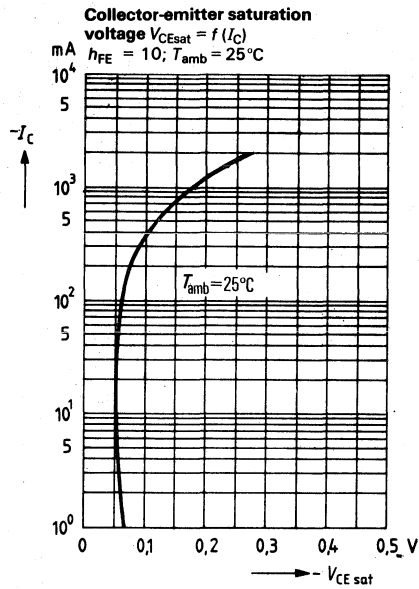
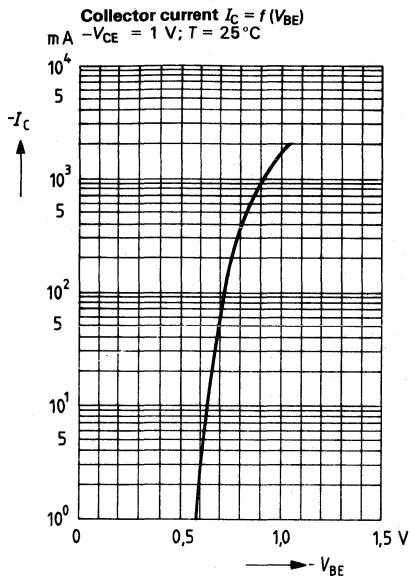

NPN Silicon Epibase Transistors

BD 433
BD 435
BD 437
BD 439
BD 441

The transistors BD 433, BD 435, BD 437, BD 439, and BD 441 are NPN silicon epibase power transistors in TO 126 plastic package (12 A 3 DIN 41 869, sheet 4). The collector is electrically connected to the metallic mounting area. The transistors are particularly suitable for use in push-pull output stages, driver stages as well as for general AF applications. Their complementary types are the PNP transistors BD 434, BD 436, BD 438, BD 440, and BD 442.

Type	Ordering code
BD 433	Q62702-D201
BD 433/BD 434 paired	Q62702-D217
BD 435	Q62702-D203
BD 435/BD 436 paired	Q62702-D218
BD 437	Q62702-D212
BD 437/BD 438 paired	Q62702-D219
BD 439	Q62702-D280
BD 439/BD 440 paired	Q62702-D284
BD 441	Q62702-D285
BD 441/BD 442 paired	Q62702-D325
Mica washer	Q62902-B62
Spring washer	
A 3 DIN 137	Q62902-B63

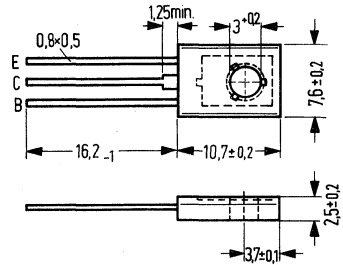

Approx. weight 0.5 g Dimensions in mm

Transistor fixing with M 3 screw. Starting torque < 0.8 Nm, washer or spring washer should be used.

1) If a 50 μ mica washer (ungreased) is used, the thermal resistance increases by 8 K/W and in case of a greased one by 4 K/W.

Maximum ratings

	BD 433	BD 435	BD 437	BD 439	BD 441	
Collector-emitter voltage	V_{CEO} 22	32	45	60	80	V
Collector-emitter voltage	V_{CES} 22	32	45	60	80	V
Collector-base voltage	V_{CBO} 22	32	45	60	80	V
Emitter-base voltage	V_{EBO} 5	5	5	5	5	V
Collector current	I_C 4	4	4	4	4	A
Collector peak current	I_{CM} 7	7	7	7	7	A
Emitter peak current	I_{EM} 7	7	7	7	7	A
Base current	I_B 1	1	1	1	1	A
Junction temperature	T_j 150	150	150	150	150	$^{\circ}C$
Storage temperature range	T_{stg}	-55 to +150				$^{\circ}C$
Total power dissipation ($T_{case} \leq 25^{\circ}C$; $V_{CE} \leq 12$)	P_{tot} 36	36	36	36	36	W

Thermal resistance

Junction to ambient air	R_{thJA} ≤ 100	≤ 100	≤ 100	≤ 100	≤ 100	K/W
Junction to mounting area	$R_{thJC}^{(1)}$ $\leq 3,5$	$\leq 3,5$	$\leq 3,5$	$\leq 3,5$	$\leq 3,5$	K/W

Static characteristics ($T_{\text{case}} = 25^{\circ}\text{C}$)

		BD 433	BD 435	BD 437	BD 439	BD 441	
Collector-emitter breakdown voltage ($I_C = 1000 \text{ mA}$)	$V_{(\text{BR})\text{CEO}}$	> 22	> 32	> 45	> 60	> 80	V
Collector-emitter breakdown voltage ($I_C = 100 \mu\text{A}$)	$V_{(\text{BR})\text{CES}}$	> 22	> 32	> 45	> 60	> 80	V
Collector-base breakdown voltage ($I_C = 100 \mu\text{A}$)	$V_{(\text{BR})\text{CBO}}$	> 22	> 32	> 45	> 60	> 80	V
Emitter-base breakdown voltage ($I_E = 1 \text{ mA}$)	$V_{(\text{BR})\text{EBO}}$	> 5	> 5	> 5	> 5	> 5	V
Collector cutoff current ($V_{\text{CB}} = 22 \text{ V}$)	I_{CBO}	< 100	-	-	-	-	μA
Collector cutoff current ($V_{\text{CB}} = 32 \text{ V}$)	I_{CBO}	-	< 100	-	-	-	μA
Collector cutoff current ($V_{\text{CB}} = 45 \text{ V}$)	I_{CBO}	-	-	< 100	-	-	μA
Collector cutoff current ($V_{\text{CB}} = 60 \text{ V}$)	I_{CBO}	-	-	-	< 100	-	μA
Collector cutoff current ($V_{\text{CB}} = 80 \text{ V}$)	I_{CBO}	-	-	-	-	< 100	μA
Collector cutoff current ($V_{\text{CB}} = 10 \text{ V}$; $T_{\text{amb}} = 150^{\circ}\text{C}$)	I_{CBO}	< 1	< 1	< 1	< 1	< 1	mA
Collector cutoff current ($V_{\text{CB}} = V_{\text{CB max}}$; $T_{\text{amb}} = 150^{\circ}\text{C}$)	I_{CBO}	< 3	< 3	< 3	< 3	< 3	mA
Base-emitter forward voltage ($I_C = 2 \text{ A}$; $V_{\text{CE}} = 1 \text{ V}$)	V_{BE}	< 1.1	< 1.1	< 1.2	< 1.5	< 1.5	V
Base-emitter forward voltage ($I_C = 3 \text{ A}$; $V_{\text{CE}} = 1 \text{ V}$)	V_{BE}	-	-	< 1.3	< 1.6	< 1.6	V
Collector-emitter saturation voltage ($I_C = 2 \text{ A}$) ¹⁾	V_{CEsat}	< 0.8	< 0.8	-	-	-	V
Collector-emitter saturation voltage ($I_C = 2 \text{ A}$; $I_B = 0.2 \text{ A}$)	V_{CEsat}	< 0.5	< 0.5	< 0.6	< 0.8	< 0.8	V
Collector-emitter saturation voltage ($I_C = 3 \text{ A}$; $I_B = 0.3 \text{ A}$)	V_{CEsat}	-	-	< 0.7	< 0.9	< 0.9	V
DC current gain ($I_C = 10 \text{ mA}$; $V_{\text{CE}} = 5 \text{ V}$)	h_{FE}	> 40	> 40	> 30	> 20	> 15	-
($I_C = 500 \text{ mA}$; $V_{\text{CE}} = 1 \text{ V}$) ²⁾	h_{FE}	> 85	> 85	> 85	> 40	> 40	-
($I_C = 2 \text{ A}$; $V_{\text{CE}} = 1 \text{ V}$)	h_{FE}	> 50	> 50	> 40	> 25	> 15	-

1) For the characteristic which passes through the point $I_C = 2.2 \text{ mA}$ and $V_{\text{CE}} = 1 \text{ V}$ at constant base current.

2) Available as matching pairs with BD 434, BD 436, BD 438, BD 440, and BD 442. Condition for matching pairs $h_{\text{FE1}}/h_{\text{FE2}} \leq 1.41$.

BD 433
 BD 435
 BD 437
 BD 439
 BD 441

Dynamic characteristics ($T_{case} = 25^{\circ}C$)

	BD 433	BD 435	BD 437	BD 439	BD 441	
Transition frequency ($I_C = 0.25 A$; $V_{CE} = 1 V$; $f = 1 MHz$)	> 3	> 3	> 3	> 3	> 3	MHz
Cutoff frequency in common emitter configuration ($I_C = 0.25 A$; $V_{CE} = 1 V$)	> 20	> 20	> 20	> 20	> 20	kHz

**Total perm. power dissipation
 versus temperature**

$P_{tot} = f(T_{case})$; $V_{CE} = 0$ to $12 V$

BD 433, BD 435, BD 437,
 BD 439, BD 441

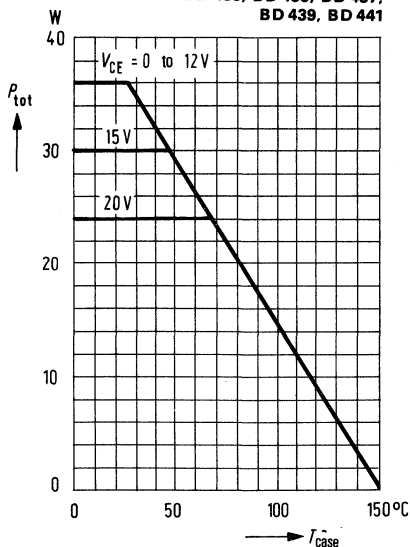

Permissible pulse load

$r_{thJC} = f(t)$; $v = \text{parameter}$

BD 433, BD 435, BD 437,
 BD 439, BD 441

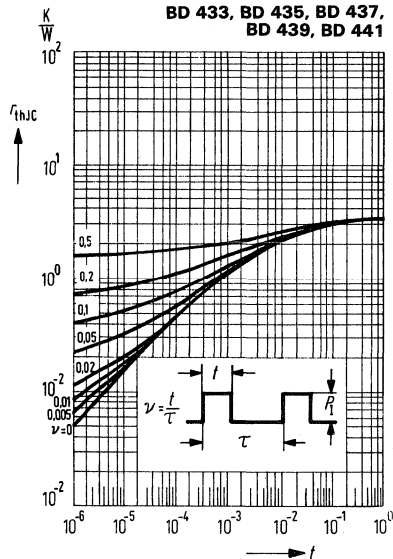

BD 433
BD 435
BD 437
BD 439
BD 441

Permissible operating range

$I_C = f(V_{CE}); T_{case} = 25^\circ C, v = 0$

BD 433, BD 435, BD 437

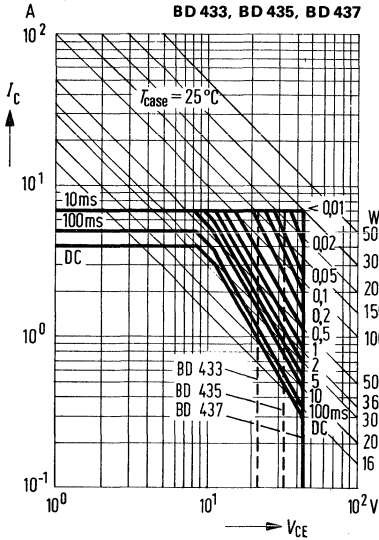

Permissible operating range

$I_C = f(V_{CE}); T_{case} = 25^\circ C, v = 0$

BD 439, BD 441

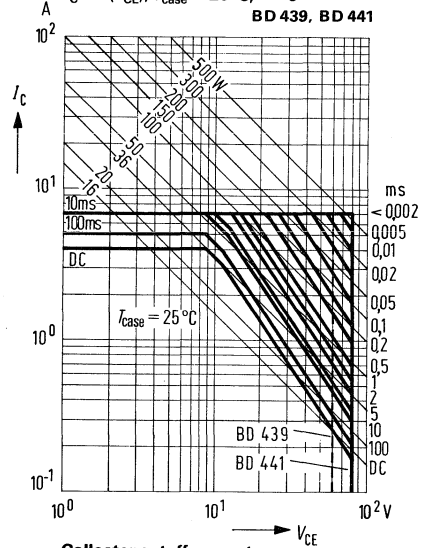

DC current gain $h_{FE} = f(I_C)$:

$V_{CE} = 1 V; T_{case} = \text{parameter}$

BD 433, BD 435, BD 437,
BD 439, BD 441

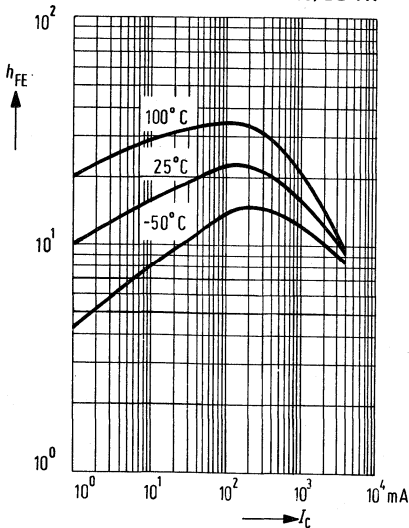

Collector cutoff current versus temperature $I_{CBO} = f(T_{case})$

$V_{CB} = V_{CBmax}$

BD 433, BD 435, BD 437,
BD 439, BD 441

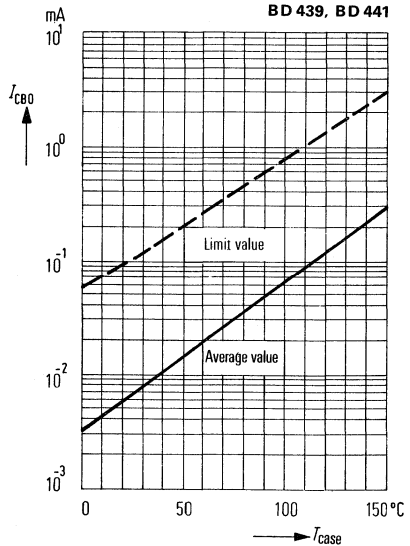

BD 433
BD 435
BD 437
BD 439
BD 441

Collector current $I_C = f(V_{BE})$:

$V_{CE} = 2 \text{ V}; T_{\text{case}} = 25^\circ$

BD 433, BD 435, BD 437,

BD 439, BD 441

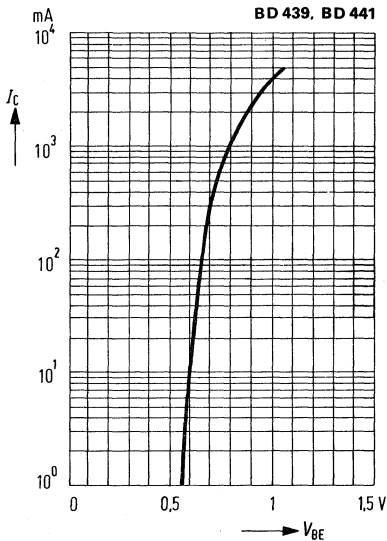

Collector-emitter saturation voltage

$V_{CE\text{sat}} = f(I_C); h_{FE} = 10; T_{\text{amb}} = 25^\circ \text{C}$

BD 433, BD 435, BD 437,

BD 439, BD 441

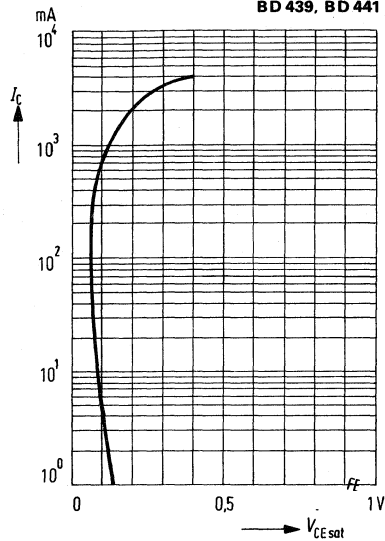

Output characteristics $I_C = f(V_{CE})$

$I_B = \text{parameter}$

(common emitter configuration)

BD 433, BD 435, BD 437,

BD 439, BD 441

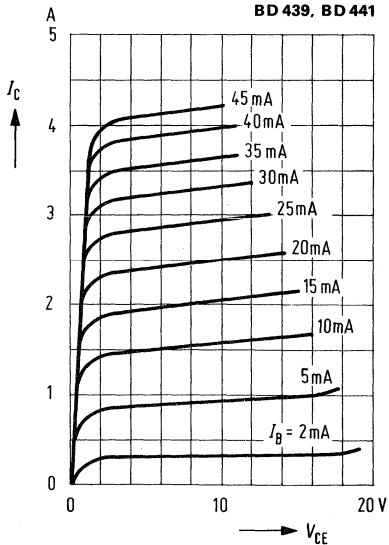

Transition frequency $f_T = f(I_C)$

$T_{\text{case}} = 25^\circ \text{C}$

BD 433, BD 435, BD 437,

BD 439, BD 441

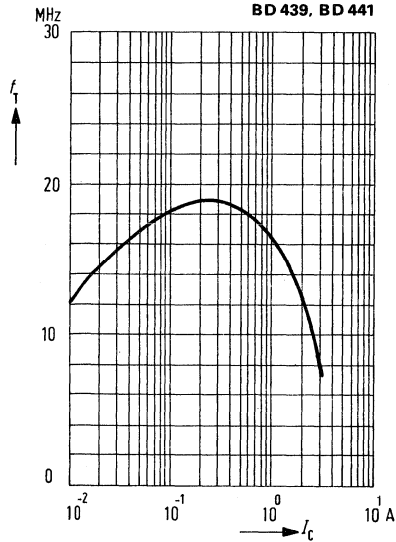

Power transistors for complementary AF stages

The transistors BD 434, BD 436, BD 438, BD 440 and BD 442 are PNP silicon epibase power transistors in a TO 126 plastic package (12 A 3 DIN 41869, sheet 4). The collector is electrically connected to the metallic mounting area. The transistors are particularly suitable for use in push-pull output stages, driver stages and for general AF applications. Their complementary types are the NPN transistors BD 433, BD 435, BD 437, BD 439, and BD 441.

Type	Ordering code
BD 434	Q62702-D202
BD 434/BD 433 paired	Q62702-D217
BD 436	Q62702-D204
BD 436/BD 435 paired	Q62702-D218
BD 438	Q62702-D213
BD 438/BD 437 paired	Q62702-D219
BD 440	Q62702-D281
BD 440/BD 439 paired	Q62702-D284
Bd 442	Q62702-D283
BD 442/BD 441 paired	Q62702-D285
Mica washer	Q62902-B62
Spring washer A3 DIN137	Q62902-B63

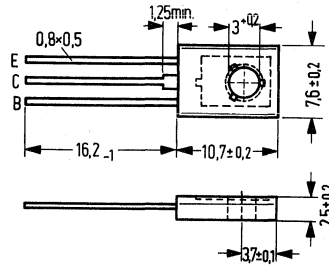

Approx. weight 0.5 g Dimensions in mm

Transistor fixing with M 3 screw. Starting torque max. 0.8 Nm; washer or spring washer should be used.

1) If a 50 μ mica washer (ungreased) is used, the thermal resistance increases by 8 K/W and in case of a greased one by 4 K/W.

Maximum ratings

		BD 434	BD 436	BD 438	BD 440	BD 442	
Collector-emitter voltage	$-V_{CEO}$	22	32	45	60	80	V
Collector-emitter voltage	$-V_{CES}$	22	32	45	60	80	V
Collector-base voltage	$-V_{CBO}$	22	32	45	60	80	V
Emitter-base voltage	$-V_{EBO}$	5	5	5	5	5	V
Collector current	$-I_C$	4	4	4	4	4	A
Collector peak current ($t < 10$ ms)	$-I_{CM}$	7	7	7	7	7	A
Emitter peak current ($t < 10$ ms)	$-I_{EM}$	7	7	7	7	7	A
Base current	$-I_B$	1	1	1	1	1	A
Junction temperature	T_j	150	150	150	150	150	$^{\circ}\text{C}$
Storage temperature range	T_{stg}	-55 to +150					$^{\circ}\text{C}$
Total power dissipation ($T_{case} \leq 25^{\circ}\text{C}$; $V_{CE} \leq 12$ V)	P_{tot}	36	36	36	36	36	W

Thermal resistance

Junction to ambient air	R_{thJA}	≤ 100	≤ 100	≤ 100	≤ 100	≤ 100	K/W
Junction to mounting area	$R_{thJC}^{1)}$	$\leq 3,5$	$\leq 3,5$	$\leq 3,5$	$\leq 3,5$	$\leq 3,5$	K/W

Static characteristics ($T_{\text{case}} = 25^{\circ}\text{C}$)

	BD 434	BD 436	BD 438	BD 440	BD 442	
Collector-emitter breakdown voltage ($-I_C = 100 \text{ mA}$)	$-V_{(\text{BR})\text{CEO}} > 22$	> 32	> 45	> 60	> 80	V
Collector-emitter breakdown voltage ($-I_C = 100 \mu\text{A}$)	$-V_{(\text{BR})\text{CES}} > 22$	> 32	> 45	> 60	> 80	V
Collector-base breakdown voltage ($-I_C = 100 \mu\text{A}$)	$-V_{(\text{BR})\text{CBO}} > 22$	> 32	> 45	> 60	> 80	V
Emitter-base breakdown voltage ($I_E = 1 \text{ mA}$)	$-V_{(\text{BR})\text{EBO}} > 5$	> 5	> 5	> 5	> 5	
Collector cutoff current ($-V_{\text{CB}} = 22 \text{ V}$)	$-I_{\text{CBO}} < 100$	-	-	-	-	μA
Collector cutoff current ($-V_{\text{CB}} = 32 \text{ V}$)	$-I_{\text{CBO}} -$	< 100	-	-	-	μA
Collector cutoff current ($-V_{\text{CB}} = 45 \text{ V}$)	$-I_{\text{CBO}} -$	-	< 100	-	-	μA
Collector cutoff current ($-V_{\text{CB}} = 60 \text{ V}$)	$-I_{\text{CBO}} -$	-	-	< 100	-	μA
Collector cutoff current ($-V_{\text{CB}} = 80 \text{ V}$)	$-I_{\text{CBO}} -$	-	-	-	< 100	μA
Collector cutoff current ($-V_{\text{CB}} = 10 \text{ V}; T_{\text{amb}} = 150^{\circ}\text{C}$)	$-I_{\text{CBO}} < 1$	< 1	< 1	< 1	< 1	mA
Collector cutoff current ($-V_{\text{CB}} = V_{\text{CBmax}}; T_{\text{amb}} = 150^{\circ}\text{C}$)	$-I_{\text{CBO}} < 3$	< 3	< 3	< 3	< 3	mA
Base-emitter forward voltage ($-I_C = 2 \text{ A}; -V_{\text{CE}} = 1 \text{ V}$)	$-V_{\text{BE}} < 1.1$	< 1.1	< 1.2	< 1.5	< 1.5	V
Base-emitter forward voltage ($-I_C = 3 \text{ A}; -V_{\text{CE}} = 1 \text{ V}$)	$-V_{\text{BE}} -$	-	< 1.3	< 1.6	< 1.6	V
Collector-emitter saturation voltage ($-I_C = 2 \text{ A}$) ¹⁾	$-V_{\text{CEsat}} < 0.8$	< 0.8	-	-	-	V
Collector-emitter saturation voltage ($-I_C = 2 \text{ A}; -I_B = 0.2 \text{ A}$)	$-V_{\text{CEsat}} < 0.5$	< 0.5	< 0.6	< 0.8	< 0.8	V
Collector-emitter saturation voltage ($-I_C = 3 \text{ A}; -I_B = 0.3 \text{ A}$)	$-V_{\text{CEsat}} -$	-	< 0.7	< 0.9	< 0.9	V
DC current gain ($-I_C = 10 \text{ mA}; -V_{\text{CE}} = 5 \text{ V}$)	$h_{\text{FE}} > 40$	> 40	> 30	> 20	> 15	-
($-I_C = 500 \text{ mA}; -V_{\text{CE}} = 1 \text{ V}$) ²⁾	$h_{\text{FE}} > 85$	> 85	> 85	> 40	> 40	-
($-I_C = 2 \text{ A}; -V_{\text{CE}} = 1 \text{ V}$)	$h_{\text{FE}} > 50$	> 50	> 40	> 25	> 15	-

1) For the characteristics which passes through the point $I_C = 2.2 \text{ mA}$ and $V_{\text{CE}} = 1 \text{ V}$ at constant base current.

2) Available as matching pairs with BD 433, BD 435, BD 437, BD 439, and BD 441. Condition for matching pairs $h_{\text{FE1}}/h_{\text{FE2}} \leq 1.41$.

BD 434
 BD 436
 BD 438
 BD 440
 BD 442

Dynamic characteristics ($T_{case} = 25^{\circ}C$)

	BD 434	BD 436	BD 438	BD 440	BD 442	
Transition frequency ($-I_C = 0,25 A$; $-V_{CE} = 1 V$; $f = 1 MHz$)	> 3	> 3	> 3	> 3	> 3	MHz
Cutoff frequency in common emitter configuration ($-I_C = 0.25 A$; $-V_{CE} = 1 V$)	> 20	> 20	> 20	> 20	> 20	kHz

Total perm. power dissipation
 versus temperature

$P_{tot} = f(T_{case})$; $V_{CE} = 0$ to 12 V
 BD 434, BD 436, BD 438,
 BD 440, BD 442

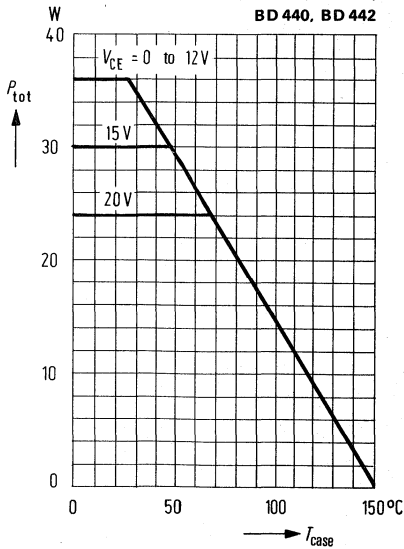

Permissible pulse load
 $r_{thJC} = f(t)$; $v =$ parameter

BD 434, BD 436, BD 438,
 BD 440, BD 442

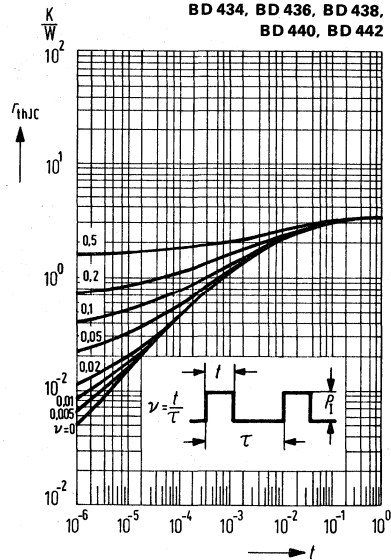

Permissible operating range

BD 434
BD 436
BD 438
BD 440
BD 442

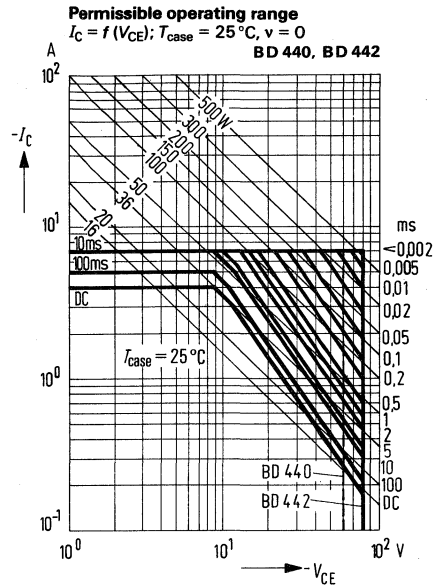
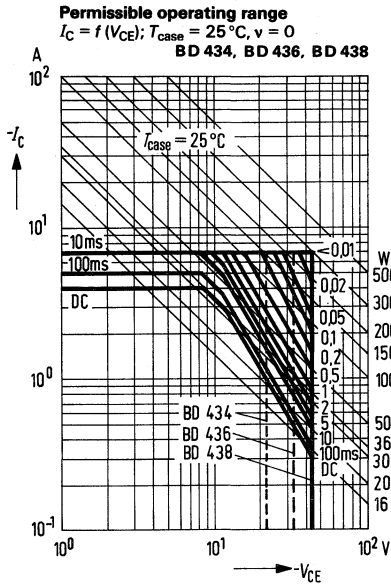

DC current gain $h_{FE} = f(I_C)$
 $V_{CE} = 1\text{V}; T_{case} = \text{parameter}$
BD 434, BD 436, BD 438,
BD 440, BD 442

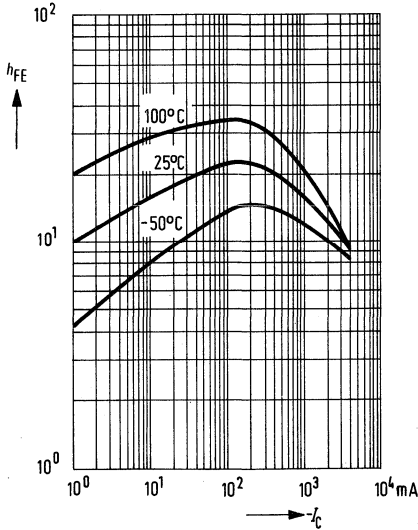

Collector cutoff current versus temperature $-I_{CBO} = f(T_{case})$
 $-V_{CB} = -V_{CBmax}$

BD 434, BD 436, BD 438,
BD 440, BD 442

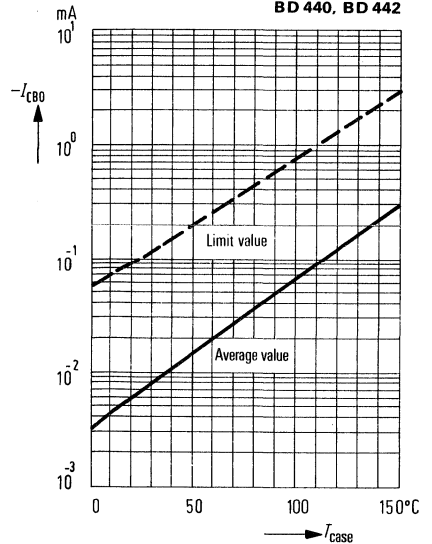

BD 434
BD 436
BD 438
BD 440
BD 442

Collector current $I_C = f(V_{BE})$
 $-V_{CE} = 2\text{ V}; T_{\text{case}} = 25^\circ\text{C}$

BD 434, BD 436, BD 438,
BD 440, BD 442

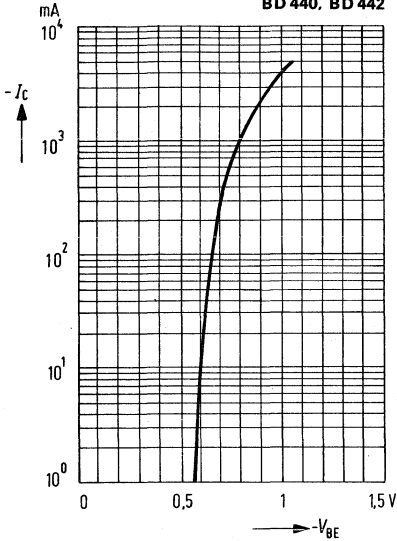

Collector-emitter saturation voltage
 $V_{CE\text{sat}} = f(I_C); h_{FE} = 10$

BD 434, BD 436, BD 438,
BD 440, BD 442

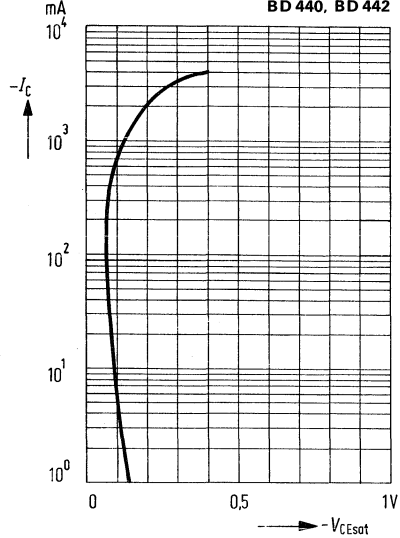

Output characteristics $I_C = f(V_{CE})$
 $I_B = \text{parameter}$
 (common emitter configuration)

BD 434, BD 436, BD 438,
BD 440, BD 442

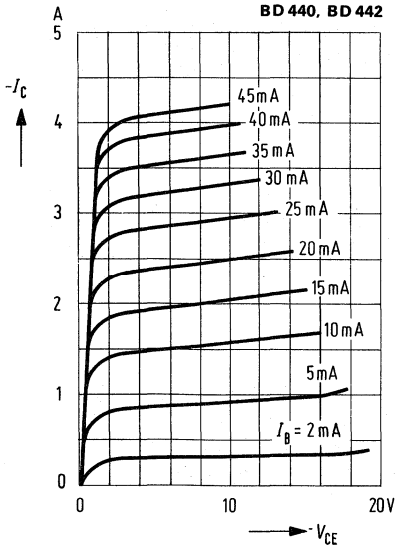

Transition frequency $f_T = f(I_C)$
 $T_{\text{case}} = 25^\circ\text{C}$

BD 434, BD 436, BD 438,
BD 440, BD 442

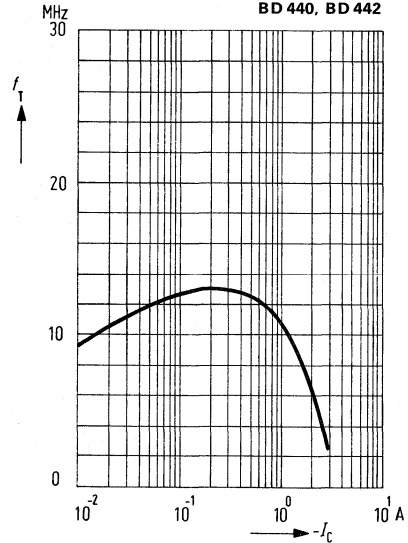

BD 487 and BD 488 are epitaxial PNP silicon planar transistors in a plastic package similar to TO 202. The collector is electrically connected to the metallic mounting area. The transistors are particularly designed for switching applications in flash devices.

Type	Ordering code
BD 487	Q62702-D929
Bd 488	Q62702-D930

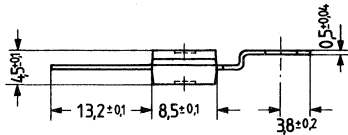

Available upon request also with bent fixing plate.

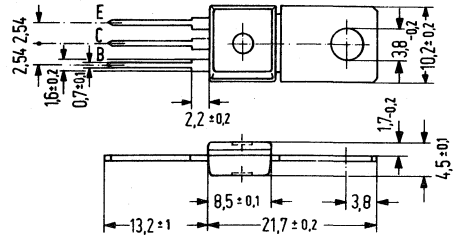

Approx. weight 15 g.

Dimensions in mm

Maximum ratings ($T_{amb} = 25^{\circ}\text{C}$)

Collector-emitter voltage	
Collector-emitter voltage	
Collector-base voltage	
Emitter-base voltage	
Collector current	
Collector peak current ($t \leq 10$ ms)	
Emitter peak current	
Base current	
Base peak current	
Junction temperature	
Storage temperature range	
Total power dissipation ($T_{case} = 25^{\circ}\text{C}$)	

	BD 487	BD 488	
$-V_{CEO}$	25	45	V
$-V_{CES}$	30	45	V
$-V_{CBO}$	30	45	V
$-V_{EBO}$	5	5	V
$-I_C$	12	12	A
$-I_{CM}$	15	15	A
I_{EM}	15	15	A
$-I_B$	2	2	A
I_{BM}	5	5	A
T_j	150	150	$^{\circ}\text{C}$
T_{stg}	-55 to +150		$^{\circ}\text{C}$
P_{tot}	12,5	12,5	W

Thermal resistance

Junction to ambient air	R_{thJA}	≤ 65	≤ 65	K/W
Junction to mounting area	R_{thJC}	≤ 10	≤ 10	K/W

Static characteristics ($T_{amb} = 25^{\circ}\text{C}$)

	BD 487	BD 488		
Collector cutoff current ($-V_{CE} = 30\text{ V}$)	$-I_{CES}$	≤ 1	≤ 1	μA
Collector cutoff current ($-V_{CE} = 30\text{ V}; T_{amb} = 125^{\circ}\text{C}$)	$-I_{CES}$	≤ 100	≤ 100	μA
DC current gain ($-I_C = 12\text{ A}; -V_{CE} = 0.7\text{ V}$)	h_{FE}	≥ 25	≥ 25	–
Base-emitter forward voltage ($-I_C = 12\text{ A}; -V_{CE} = 0.7\text{ V}$)	$-V_{BE}$	< 1.7	< 1.7	V
DC current gain ($-I_C = 0.1\text{ A}; -V_{CE} = 0.7\text{ V}$)	h_{FE}	200	200	–
Collector-emitter forward voltage ($-I_C = 0.1\text{ A}; -V_{CE} = 0.7\text{ V}$)	$-V_{CE}$	< 0.8	< 0.8	V

Dynamic characteristics ($T_{amb} = 25^{\circ}\text{C}$)

Transition frequency ($-V_{CE} = 10\text{ V}; -I_C = 0.2\text{ A}$)	f_T	≥ 50	≥ 50	MHz
Collector-base capacitance ($-V_{CE} = 10\text{ V}$)	C_{CB}	130	130	pF
Switching times ($-I_C = 2\text{ A}; I_{B1}$ approx. I_{B2} approx. 0.2 A)	t_{on}	< 0.5	< 0.5	μs
	t_{off}	< 2	< 2	μs

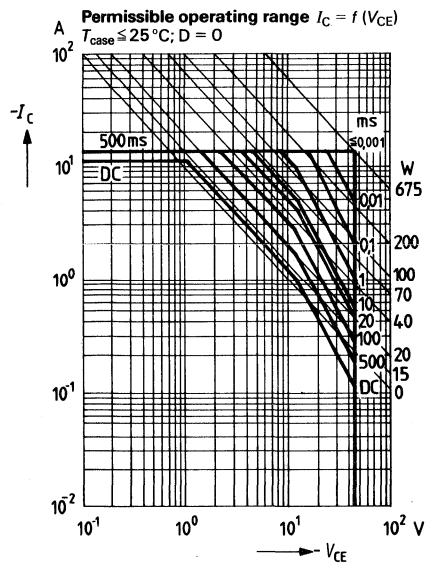
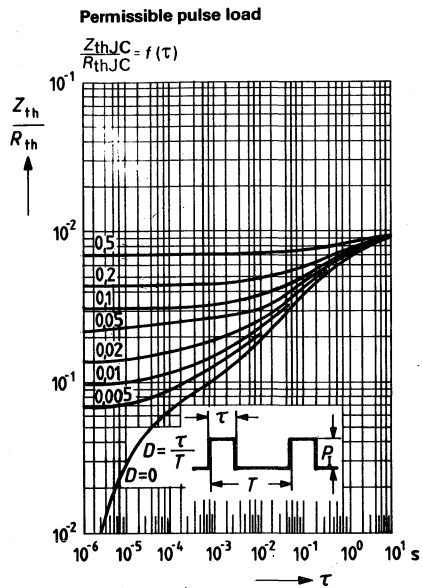
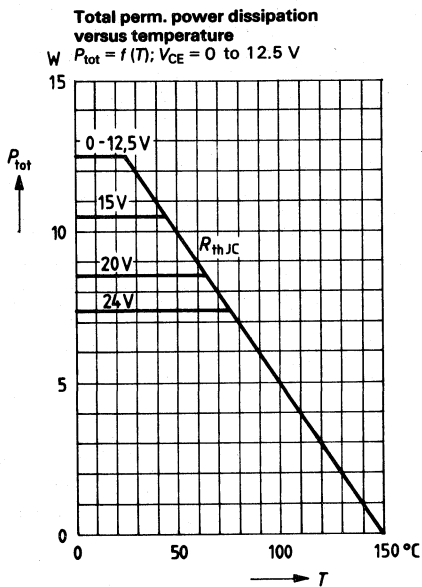

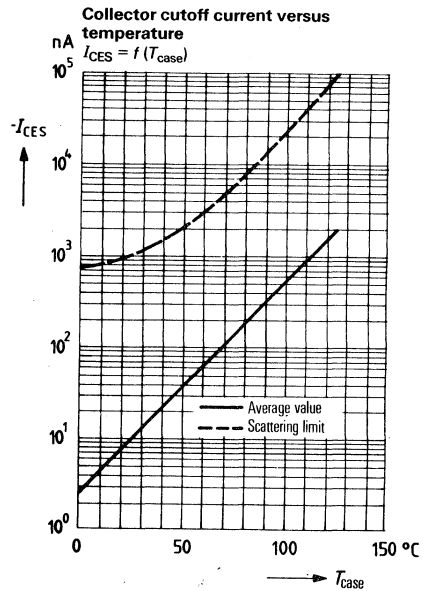
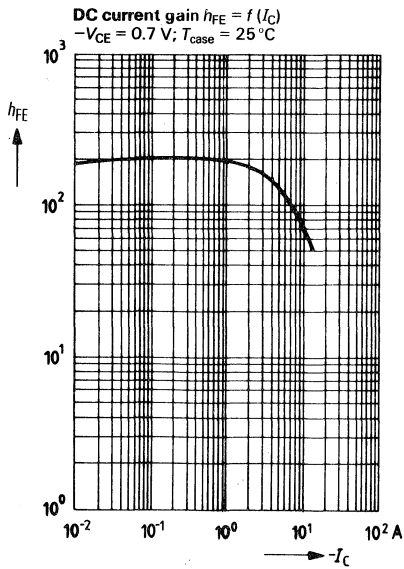
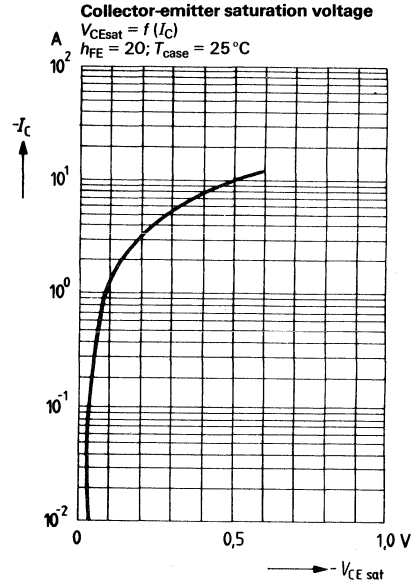
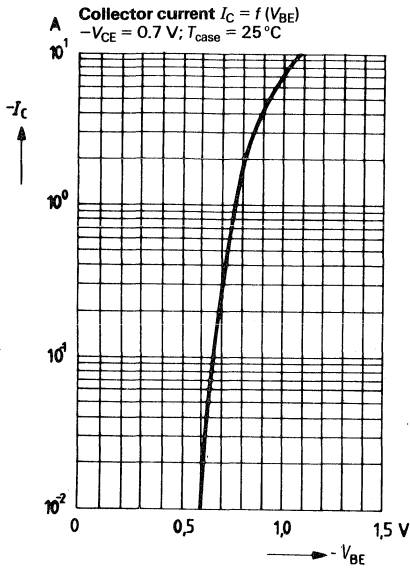

BD 524 is an epitaxial NPN silicon planar transistor in TO 126 plastic package (12 A 3 DIN 41869, sheet 4). It is particularly intended for use as driver transistor in horizontal deflection stages of TV sets as well as for universal applications at higher reverse voltages.

Type	Ordering code
BD 524	Q62702-D905
Spring washer	
A3 DIN 137	Q62902-B63
Mica washer	Q62902-B62

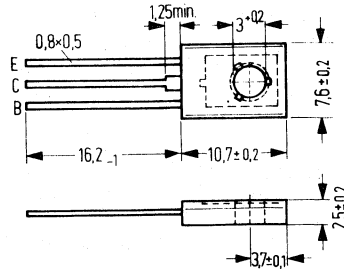

Approx. weight 0.5 g. Dimensions in mm
 Transistor fixing with M 3 screw
 Starting torque < 0.8 Nm
 Washer or spring washer should be used

Maximum ratings ($T_{amb} = 25^{\circ}\text{C}$)

Collector-emitter voltage	V_{CE0}	100	V
Collector-emitter voltage	V_{CES}	160	V
Emitter-base voltage	V_{EBO}	5	V
Collector current	I_C	0.8	A
Collector peak current	I_{CM}	1	A
Base current	I_B	100	mA
Junction temperature	T_j	150	$^{\circ}\text{C}$
Storage temperature range	T_{stg}	-55 to + 125	$^{\circ}\text{C}$
Total power dissipation ($T_{case} \leq 25^{\circ}\text{C}$)	P_{tot}	5	W

Thermal resistance

Junction to ambient air	R_{thJA}	< 110	K/W
Junction to case	R_{thJC}	< 25	K/W

Static characteristics ($T_{\text{amb}} = 25^{\circ}\text{C}$)

Collector cutoff current ($V_{\text{CB}} = 140\text{ V}$)	I_{CBO}	< 100	nA
Collector cutoff current ($V_{\text{CB}} = 140\text{ V}$; $T_{\text{amb}} = 125^{\circ}\text{C}$)	I_{CBO}	< 10	μA
Emitter cutoff current ($V_{\text{EB}} = 5\text{ V}$)	I_{EBO}	< 10	μA
Collector-emitter breakdown voltage ($I_{\text{C}} = 50\text{ mA}$)	$V_{(\text{BR})\text{CEO}}$	> 100	V
Collector-emitter breakdown voltage ($I_{\text{C}} = 100\ \mu\text{A}$)	$V_{(\text{BR})\text{CES}}$	> 160	V
Emitter-base breakdown voltage ($I_{\text{E}} = 1\ \mu\text{A}$)	$V_{(\text{BR})\text{EBO}}$	> 5	V
DC current gain ($I_{\text{C}} = 100\text{ mA}$; $V_{\text{CE}} = 1\text{ V}$)	h_{FE}	> 40	–
($I_{\text{C}} = 200\text{ mA}$; $V_{\text{CE}} = 1\text{ V}$)	h_{FE}	> 20	–
Base-emitter forward voltage ($I_{\text{C}} = 200\text{ mA}$; $V_{\text{CE}} = 1\text{ V}$)	V_{BE}	< 1.3	V
Collector-emitter saturation voltage ($I_{\text{C}} = 300\text{ mA}$; $I_{\text{B}} = 30\text{ mA}$)	V_{CEsat}	< 1	V
Base-emitter saturation voltage ($I_{\text{C}} = 300\text{ mA}$; $I_{\text{B}} = 30\text{ mA}$)	V_{BEsat}	< 1.4	V

Dynamic characteristics ($T_{\text{amb}} = 25^{\circ}\text{C}$)

Transition frequency ($I_{\text{C}} = 10\text{ mA}$; $V_{\text{CE}} = 5\text{ V}$; $f = 20\text{ MHz}$)	f_{T}	100	MHz
--	----------------	-----	-----

NPN Silicon Epibase Transistors

BD 611
BD 613
BD 615
BD 617
BD 619

The transistors BD 611, BD 613, BD 615, BD 617, and BD 619 are NPN silicon epibase power transistors in a plastic package similar to TO 202. The collector is electrically connected to the metallic mounting area. The transistors are particularly suitable for use in push-pull output stages, driver stages as well as for general AF applications. Their complementary types are the PNP transistors BD 612, BD 614, BD 616, BD 618, and BD 620.

Type	Ordering code	Type	Ordering code
BD 611	Q62702-D946	BD 611/BD 612 pair.	Q62702-D1103
BD 613	Q62702-D948	BD 613/BD 614 pair.	Q62702-D1104
BD 615	Q62702-D950	BD 615/BD 616 pair.	Q62702-D1105
BD 617	Q62702-D952	BD 617/BD 618 pair.	Q62702-D1106
BD 619	Q62702-D954	BD 619/BD 620 pair.	Q62702-D1107

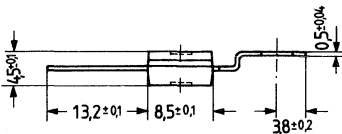

Available upon request also with bent fixing plate

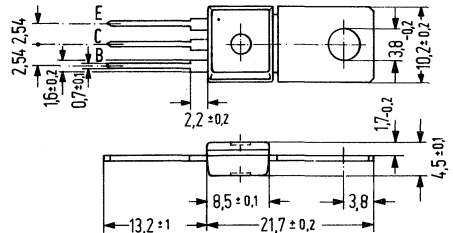

Approx. weight 15 g.

Dimensions in mm

Maximum ratings

		BD 611	BD 613	BD 615	BD 617	BD 619	
Collector-emitter voltage	V_{CEO}	22	32	45	60	80	V
Collector-emitter voltage	V_{CES}	22	32	45	60	80	V
Collector-base voltage	V_{CB0}	22	32	45	60	80	V
Emitter-base voltage	V_{EBO}	5	5	5	5	5	V
Collector current	I_C	4	4	4	4	4	A
Collector peak current ($t < 11$ ms)	I_{CM}	7	7	7	7	7	A
Emitter peak current ($t < 10$ ms)	I_{EM}	7	7	7	7	7	A
Base current	I_B	1	1	1	1	1	A
Junction temperature	T_j	150	150	150	150	150	°C
Storage temperature range	T_{stg}	-55 to +150					°C
Total power dissipation ($T_{case} \leq 25^\circ\text{C}$)	P_{tot}	15	15	15	15	15	W

Thermal resistance

		$\leq 62,5$	$\leq 62,5$	$\leq 62,5$	$\leq 62,5$	$\leq 62,5$	K/W
Junction to ambient air	R_{thJA}	$\leq 8,3$	$\leq 8,3$	$\leq 8,3$	$\leq 8,3$	$\leq 8,3$	K/W
Junction to mounting area	R_{thJC}						K/W

Static characteristics ($T_{\text{case}} = 25^{\circ}\text{C}$)

		BD 611	BD 613	BD 615	BD 617	BD 619	
Collector-emitter breakdown voltage ($I_C = 100 \text{ mA}$)	$V_{(\text{BR})\text{CEO}}$	> 22	> 32	> 45	> 60	> 80	V
Collector-emitter breakdown voltage ($I_C = 100 \mu\text{A}$)	$V_{(\text{BR})\text{CES}}$	> 22	> 32	> 45	> 60	> 80	V
Collector-base breakdown voltage ($I_C = 100 \mu\text{A}$)	$V_{(\text{BR})\text{CBO}}$	> 22	> 32	> 45	> 60	> 80	V
Emitter-base breakdown voltage ($I_E = 1 \text{ mA}$)	$V_{(\text{BR})\text{EBO}}$	> 5	> 5	> 5	> 5	> 5	V
Collector cutoff current ($V_{\text{CB}} = 22 \text{ V}$)	I_{CBO}	< 100	–	–	–	–	μA
Collector cutoff current ($V_{\text{CB}} = 32 \text{ V}$)	I_{CBO}	–	< 100	–	–	–	μA
Collector cutoff current ($V_{\text{CB}} = 45 \text{ V}$)	I_{CBO}	–	–	< 100	–	–	μA
Collector cutoff current ($V_{\text{CB}} = 60 \text{ V}$)	I_{CBO}	–	–	–	< 100	–	μA
Collector cutoff current ($V_{\text{CB}} = 80 \text{ V}$)	I_{CBO}	–	–	–	–	< 100	μA
Collector cutoff current ($V_{\text{CB}} = 10 \text{ V}$; $T_{\text{amb}} = 150^{\circ}\text{C}$)	I_{CBO}	< 1	< 1	< 1	< 1	< 1	mA
Collector cutoff current ($V_{\text{CB}} = V_{\text{CBmax}}$; $T_{\text{amb}} = 150^{\circ}\text{C}$)	I_{CBO}	< 3	< 3	< 3	< 3	< 3	mA
Base-emitter forward voltage ($I_C = 2 \text{ A}$; $V_{\text{CE}} = 1 \text{ V}$)	V_{BE}	< 1.1	< 1.1	< 1.2	< 1.5	< 1.5	V
Base-emitter forward voltage ($I_C = 3 \text{ A}$; $V_{\text{CE}} = 1 \text{ V}$)	V_{BE}	–	–	< 1.3	< 1.6	< 1.6	V
Collector-emitter saturation voltage ($I_C = 2 \text{ A}$) ¹⁾	V_{CEsat}	< 0.8	< 0.8	–	–	–	V
Collector-emitter saturation voltage ($I_C = 2 \text{ A}$; $I_B = 0.2 \text{ A}$)	V_{CEsat}	< 0.5	< 0.5	< 0.6	< 0.8	< 0.8	V
Collector-emitter saturation voltage ($I_C = 3 \text{ A}$; $I_B = 0.3 \text{ A}$)	V_{CEsat}	–	–	< 0.7	< 0.9	< 0.9	V
DC current gain ($I_C = 10 \text{ mA}$; $V_{\text{CE}} = 5 \text{ V}$)	h_{FE}	> 40	> 40	> 30	> 20	> 15	–
($I_C = 500 \text{ mA}$; $V_{\text{CE}} = 1 \text{ V}$)	h_{FE}	> 85	> 85	> 85	> 40	> 40	–
($I_C = 2 \text{ A}$; $V_{\text{CE}} = 1 \text{ V}$)	h_{FE}	> 50	> 50	> 40	> 25	> 15	–

1) For the characteristics which passes through the point $I_C = 2.2 \text{ A}$ and $V_{\text{CE}} = 1 \text{ V}$ at constant base current.

BD 611
BD 613
BD 615
BD 617
BD 619

Dynamic characteristics ($T_{\text{case}} = 25^{\circ}\text{C}$)

	BD 611	BD 613	BD 615	BD 617	BD 619	
Transition frequency ($I_C = 0.25 \text{ A}; V_{CE} = 1 \text{ V};$ $f = 1 \text{ MHz}$)	> 3	> 3	> 3	> 3	> 3	MHz
Cutoff frequency in common emitter configuration ($I_C = 0.25 \text{ A}; V_{CE} = 1 \text{ V}$)	> 20	> 20	> 20	> 20	> 20	kHz

Total perm. power dissipation versus temperature

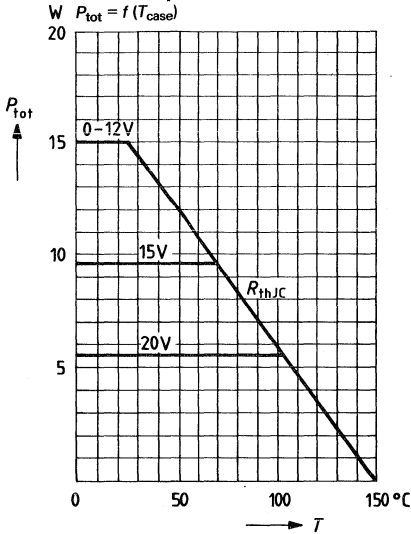

Permissible pulse load

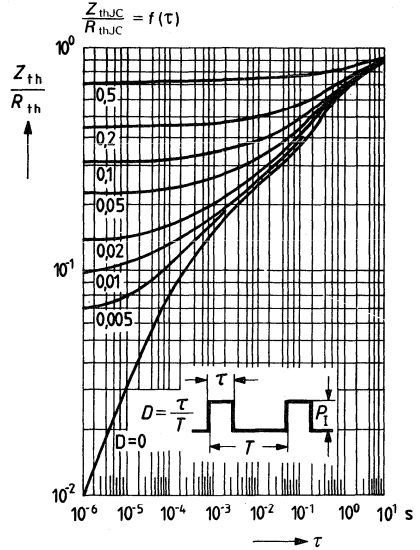

Permissible operating range

$I_C = f(V_{CE})$; $T_{case} \leq 25^\circ\text{C}$; $D = 0$

BD 611, BD 613, BD 615

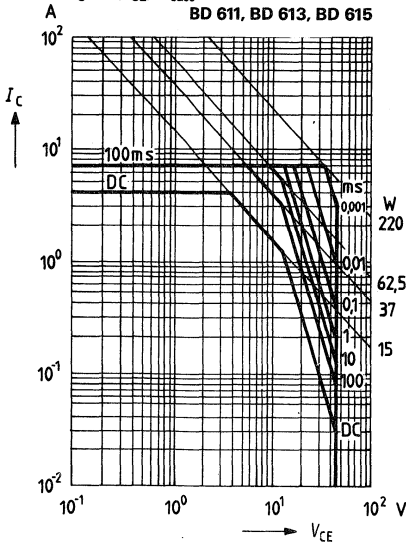

Permissible operating range

$I_C = f(V_{CE})$; $T_{case} \leq 25^\circ\text{C}$; $D = 0$

BD 617, BD 619

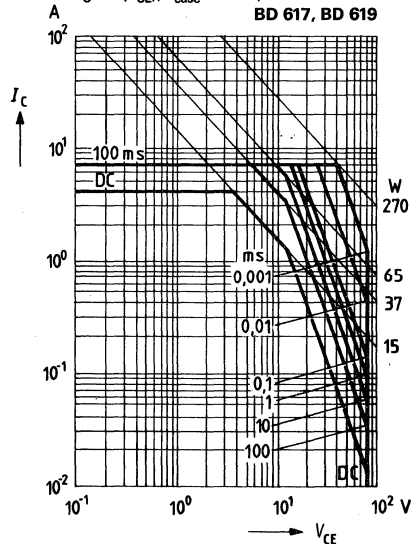

PNP Silicon Epibase Transistors

BD 612
BD 614
BD 616
BD 618
BD 620

The transistors BD 612, BD 614, BD 616, BD 618, and BD 620 are PNP silicon epibase power transistors in a plastic package similar to TO 202. The collector is electrically connected to the metallic mounting area. The transistors are particularly suitable for use in push-pull output stages, driver stages as well as for general AF applications. Their complementary types are the NPN transistors BD 611, BD 613, BD 615, BD 617, and BD 619.

Type	Ordering code
BD 612	Q62702-D947
BD 614	Q62702-D949
BD 616	Q62702-D951
BD 618	Q62702-D953
BD 620	Q62702-D955

Type	Ordering code
BD 612/BD 611 pair.	Q62702-D1103
BD 614/BD 613 pair.	Q62702-D1104
BD 616/BD 615 pair.	Q62702-D1105
BD 618/BD 617 pair.	Q62702-D1106
BD 620/BD 619 pair.	Q62702-D1107

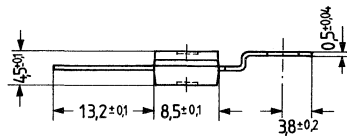

Available upon request also with bent fixing plate.

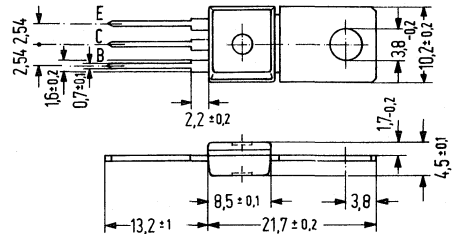

Approx. weight 15 g

Dimensions in mm

Maximum ratings

		BD 612	BD 614	BD 616	BD 618	BD 620	
Collector-emitter voltage	$-V_{CEO}$	22	32	45	60	80	V
Collector-emitter voltage	$-V_{CES}$	22	32	45	60	80	V
Collector-base voltage	$-V_{CBO}$	22	32	45	60	80	V
Emitter-base voltage	$-V_{EBO}$	5	5	5	5	5	V
Collector current	$-I_C$	4	4	4	4	4	A
Collector peak current ($t < 11$ ms)	$-I_{CM}$	7	7	7	7	7	A
Emitter peak current ($t \leq 10$ ms)	$-I_{EM}$	7	7	7	7	7	A
Base current	$-I_B$	1	1	1	1	1	A
Junction temperature	T_j	150	150	150	150	150	°C
Storage temperature range	T_{stg}		-55 to +150				°C
Total power dissipation ($T_{case} \leq 25$ °C; $V_{CE} \leq 12$ V)	P_{tot}	15	15	15	15	15	W

Thermal resistance

Junction to ambient air	R_{thJA}	$\leq 62,5$	$\leq 62,5$	$\leq 62,5$	$\leq 62,5$	$\leq 62,5$	K/W
Junction to mounting area	R_{thJC}	$\leq 8,3$	$\leq 8,3$	$\leq 8,3$	$\leq 8,3$	$\leq 8,3$	K/W

Static characteristics ($T_{\text{case}} = 25^\circ\text{C}$)

		BD 612	BD 614	BD 616	BD 618	BD 620	
Collector-emitter breakdown voltage ($-I_C = 100 \text{ mA}$)	$-V_{(\text{BR})\text{CEO}}$	> 22	> 32	> 45	> 60	> 80	V
Collector-emitter breakdown voltage ($-I_C = 100 \mu\text{A}$)	$-V_{(\text{BR})\text{CES}}$	> 22	> 32	> 45	> 60	> 80	V
Collector-base breakdown voltage ($-I_C = 100 \mu\text{A}$)	$-V_{(\text{BR})\text{CBC}}$	> 22	> 32	> 45	> 60	> 80	V
Emitter-base breakdown voltage ($I_E = 1 \text{ mA}$)	$-V_{(\text{BR})\text{EBO}}$	> 5	> 5	> 5	> 5	> 5	V
Collector cutoff current ($-V_{\text{CB}} = 22 \text{ V}$)	$-I_{\text{CBO}}$	< 100	-	-	-	-	μA
Collector cutoff current ($-V_{\text{CB}} = 32 \text{ V}$)	$-I_{\text{CBO}}$	-	< 100	-	-	-	μA
Collector cutoff current ($-V_{\text{CB}} = 45 \text{ V}$)	$-I_{\text{CBO}}$	-	-	< 100	-	-	μA
Collector cutoff current ($-V_{\text{CB}} = 60 \text{ V}$)	$-I_{\text{CBO}}$	-	-	-	< 100	-	μA
Collector cutoff current ($-V_{\text{CB}} = 80 \text{ V}$)	$-I_{\text{CBO}}$	-	-	-	-	< 100	μA
Collector cutoff current ($-V_{\text{CB}} = 10 \text{ V}; T_{\text{amb}} = 150^\circ\text{C}$)	$-I_{\text{CBO}}$	< 1	< 1	< 1	< 1	< 1	mA
Collector cutoff current ($-V_{\text{CB}} = V_{\text{CBmax}}; T_{\text{amb}} = 150^\circ\text{C}$)	$-I_{\text{CBO}}$	< 3	< 3	< 3	< 3	< 3	mA
Base-emitter forward voltage ($-I_C = 2 \text{ A}; -V_{\text{CE}} = 1 \text{ V}$)	$-V_{\text{BE}}$	< 1.1	< 1.1	< 1.2	< 1.5	< 1.5	V
Base-emitter forward voltage ($-I_C = 3 \text{ A}; -V_{\text{CE}} = 1 \text{ V}$)	$-V_{\text{BE}}$	-	-	< 1.3	< 1.6	< 1.6	V
Collector-emitter saturation voltage ($-I_C = 2 \text{ A}$) ¹⁾	$-V_{\text{CEsat}}$	< 0.8	< 0.8	-	-	-	V
Collector-emitter saturation voltage ($-I_C = 2 \text{ A}; -I_B = 0.2 \text{ A}$)	$-V_{\text{CEsat}}$	< 0.5	< 0.5	< 0.6	< 0.8	< 0.8	V
Collector-emitter saturation voltage ($-I_C = 3 \text{ A}; -I_B = 0.3 \text{ A}$)	$-V_{\text{CEsat}}$	-	-	< 0.7	< 0.9	< 0.9	V
DC current gain ($-I_C = 10 \text{ mA}; -V_{\text{CE}} = 5 \text{ V}$)	h_{FE}	> 40	> 40	> 30	> 20	> 15	-
($-I_C = 500 \text{ mA}; -V_{\text{CE}} = 1 \text{ V}$) ²⁾	h_{FE}	> 85	> 85	> 85	> 40	> 40	-
($-I_C = 2 \text{ A}; -V_{\text{CE}} = 1 \text{ V}$)	h_{FE}	> 50	> 50	> 40	> 25	> 15	-

1) For the characteristic which passes through the point $I_C = 2.2 \text{ A}$ and $V_{\text{CE}} = 1 \text{ V}$ at constant base current.

2) Available as matching pairs with BD 611, BD 613, BD 615, BD 617, and BD 619. Condition for matching pairs $h_{\text{FE1}}/h_{\text{FE2}} \leq 1.41$.

BD 612
BD 614
BD 616
BD 618
BD 620

Dynamic characteristics ($T_{\text{case}} = 25^{\circ}\text{C}$)

		BD 612	BD 614	BD 616	BD 618	BD 620	
Transition frequency ($-I_{\text{C}} = 0.25 \text{ A}$; $-V_{\text{CE}} = 1 \text{ V}$; $f = 1 \text{ MHz}$)	f_{T}	> 3	> 3	> 3	> 3	> 3	MHz
Cutoff frequency in common emitter configuration ($-I_{\text{C}} = 0.25 \text{ A}$; $-V_{\text{CE}} = 1 \text{ V}$)	f_{hfe}	> 20	> 20	> 20	> 20	> 20	kHz

BD 612
 BD 614
 BD 616
 BD 618
 BD 620

Total perm. power dissipation versus temperature

$P_{tot} = f(T); V_{CE} = 0 \text{ to } 12 \text{ V}$

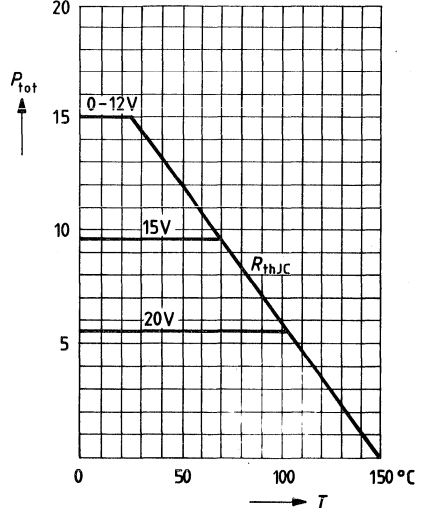

Permissible pulse load

$\frac{Z_{thJC}}{R_{thJC}} = f(\tau)$

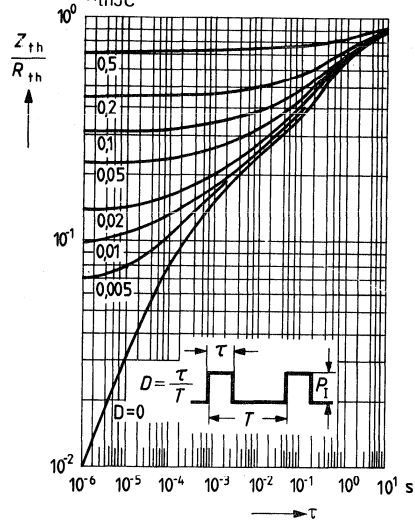

Permissible operating range

$I_C = f(V_{CE}); T_{case} \leq 25^\circ\text{C}; D = 0$

BD 612, BD 614, BD 616

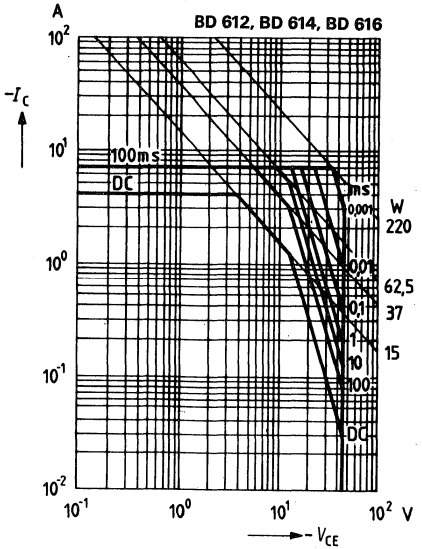

Permissible operating range

$I_C = f(V_{CE}); T_{case} \leq 25^\circ\text{C}; D = 0$

BD 618, BD 620

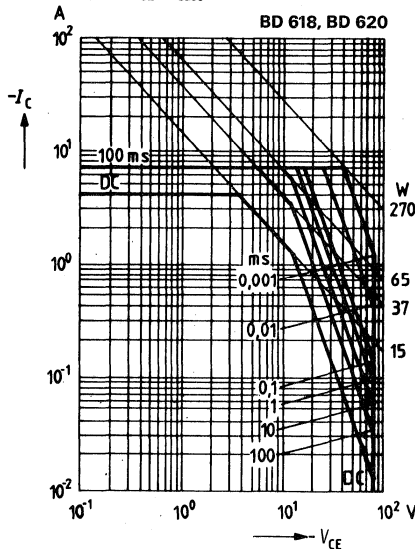

Epibase power darlington transistors (62.5W)

BD 643, BD 645, BD 647, and BD 649 are monolithic NPN silicon epibase power darlington transistors with diode and resistors in a TO 220 AB plastic package (TOP-66). The collectors of the two transistors are electrically connected to the metallic mounting area. These darlington transistors for AF applications are outstanding for particularly high current gain. Together with BD 644, BD 646, BD 648, and BD 650, they are particularly suitable for use as complementary AF push-pull output stages.

Type	Ordering code
BD 643	Q62702-D229
BD 643/BD 644	Q62702-D235
BD 645	Q62702-D231
BD 645/BD 646	Q62702-D236
BD 647	Q62702-D233
BD 647/BD 648	Q62702-D237
BD 649	Q62702-D374
BD 649/BD 650	Q62702-D376
Insulating nipple	Q62901-B55
Mica washer	Q62901-B52
Spring washer	
A 3 DIN 137	Q62902-B63

Change in dimensional drawings in preparation.

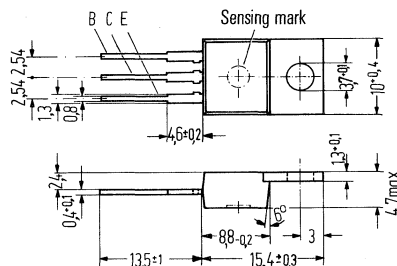
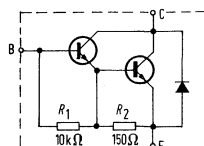

Approx. weight 18 g. Dimensions in mm

Maximum ratings

	BD 643	BD 645	BD 647	BD 649		
Collector-emitter voltage	V_{CE0}	45	60	80	100	V
Collector-base voltage	V_{CB0}	45	60	80	100	V
Base-emitter voltage	V_{EBO}	5	5	5	5	V
Collector current	I_C	8	8	8	8	A
Collector-peak current (t < 10 ms)	I_{CM}	12	12	12	12	A
Base current	I_B	150	150	150	150	mA
Storage temperature range	T_{stg}	-55 to +150				°C
Junction temperature	T_j	150	150	150	150	°C
Total power dissipation ($T_{case} \leq 25^\circ\text{C}$, $V_{CE} \leq 10\text{ V}$)	P_{tot}	62,5	62,5	62,5	62,5	W

Thermal resistance

Junction to ambient air	R_{thJA}	≤ 80	≤ 80	≤ 80	≤ 80	K/W
Junction to case ¹⁾	R_{thJC}	≤ 2	≤ 2	≤ 2	≤ 2	K/W

1) For insulated mounting: If the mica washer Q62901-B 52 (50 to 90 μm) and the insulating nipple Q62901-B 55 are used this value increases by 4 K/W and with grease by 2 K/W.

Static characteristics ($T_{amb} = 25^{\circ}\text{C}$)

		BD 643	BD 645	BD 647	BD 649	
Collector cutoff current ($V_{CB} = V_{CBmax}$)	I_{CBO}	<0.2	<0.2	<0.2	<0.2	mA
($V_{CB} = V_{CBmax}; T_{amb} = 100^{\circ}\text{C}$)	I_{CBO}	<2	<2	<2	<2	mA
Collector cutoff current ($V_{CE} = 0.5 V_{CEmax}$)	I_{CEO}	<0.5	<0.5	<0.5	<0.5	mA
Emitter cutoff current ($V_{EB} = 5\text{ V}$)	I_{EBO}	<5	<5	<5	<5	mA
Collector-emitter breakdown voltage ($I_C = 100\text{ mA}$) ¹⁾	$V_{(BR)CEO}$	>45	>60	<80	>100	V
Collector-base breakdown voltage ($I_E = 5\text{ mA}$)	$V_{(BR)CBO}$	>45	>60	>80	>100	V
Emitter-base breakdown voltage ($I_E = 2\text{ mA}$)	$V_{(BR)EBO}$	>5	>5	>5	>5	V
DC current gain ($I_C = 0.5\text{ A}, V_{CE} = 3\text{ V}$)	h_{FE}	1500	1500	1500	1500	–
($I_C = 3\text{ A}, V_{CE} = 3\text{ V}$)	h_{FE}	>750	>750	>750	>750	–
($I_C = 6\text{ A}, V_{CE} = 3\text{ V}$)	h_{FE}	750	750	750	750	–
Base-emitter forward voltage ($I_C = 3\text{ A}, V_{CE} = 3\text{ V}$)	V_{BE}	<2.5	<2.5	<2.5	<2.5	V
Collector-emitter saturation voltage ($I_C = 3\text{ A}, I_B = 12\text{ mA}$)	V_{CEsat}	<2	<2	<2	<2	V
Forward voltage of the protective diode at $I_F = 3\text{ A}$	V_F	1.8	1.8	1.8	1.8	V

Dynamic characteristics ($T_{amb} = 25^{\circ}\text{C}$)

Transition frequency ($I_C = 3\text{ A}, V_{CE} = 3\text{ V}, f = 1\text{ MHz}$)	f_T	7 (>1)	7 (>1)	7 (>1)	7 (>1)	MHz
Cutoff frequency in common emitter configuration ($I_C = 3\text{ A}, V_{CE} = 3\text{ V}$)	f_{hfe}	60	60	60	60	kHz

1) $t = 200\text{ }\mu\text{s}$, duty cycle 1%.

BD 643
BD 645
BD 647
BD 649

Total perm. power dissipation versus temperature
 $P_{tot} = f(T_{case}); V_{CE} = \text{parameter}$
BD 643, BD 645, BD 647, BD 649

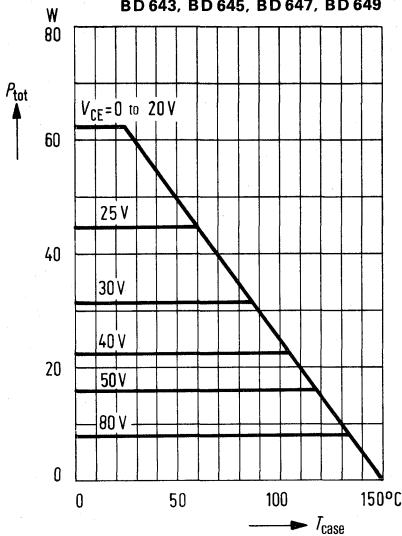

Permissible pulse load
 $r_{thJC} = f(t); v = \text{parameter}$
BD 643, BD 645, BD 647, BD 649

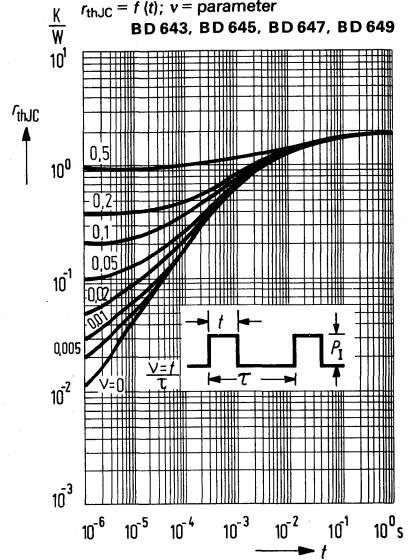

Permissible operating range
 $I_C = f(V_{CE})$ $T_{case} = 25^{\circ}C, v = 0.01$
BD 643, BD 645, BD 647, BD 649

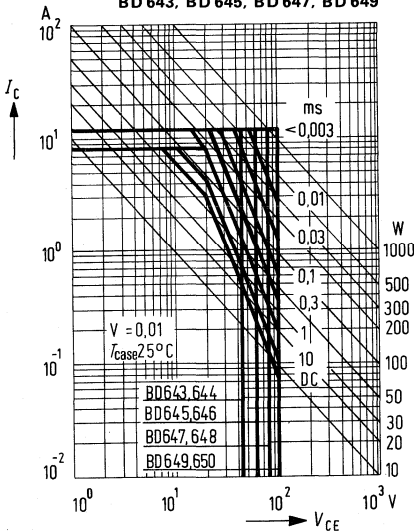

DC current gain $h_{FE} = f(I_C)$
 $V_{CE} = 3V; T_{case} = 25^{\circ}C$
BD 643, BD 645, BD 647, BD 649

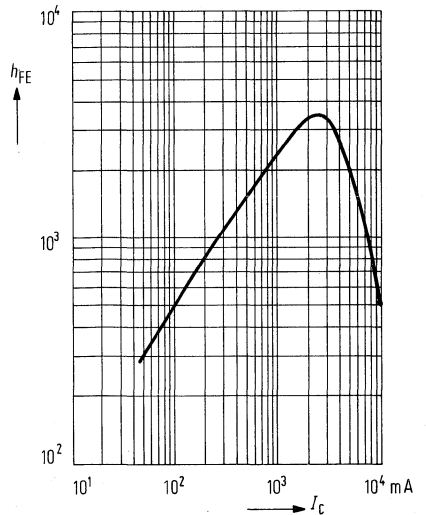

BD 643
BD 645
BD 647
BD 649

Collector current $I_C = f(V_{BE})$
 $V_{CE} = 3\text{ V}; T_{\text{case}} = 25^\circ\text{C}$
BD 643, BD 645, BD 647, BD 649

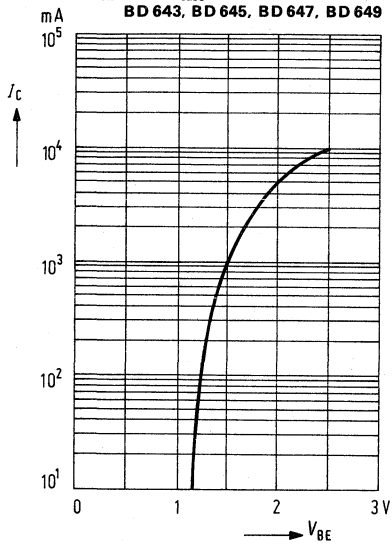

Collector-emitter saturation voltage $V_{CE\text{sat}} = f(I_C)$
 $h_{FE} = 250; T_{\text{case}} = 25^\circ\text{C}$
BD 643, BD 645, BD 647, BD 649

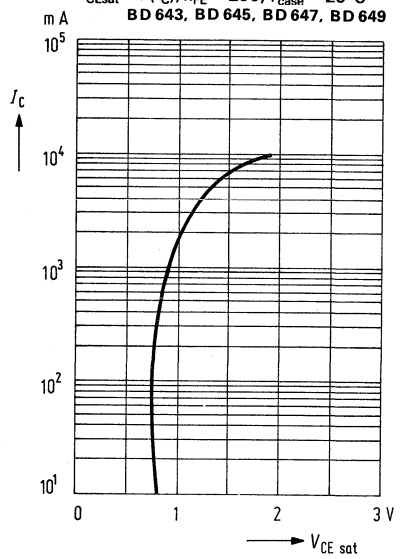

PNP Silicon Darlington Transistors

BD 644
BD 646
BD 648
BD 650

Epibase power darlington transistors (62.5W)

BD 644, BD 646, BD 648, and BD 650 are monolithic PNP silicon epibase power darlington transistors with diode and resistors in a TO 220 AB plastic package (TOP-66). The collectors of the two transistors are electrically connected to the metallic mounting area. These darlington transistors for AF applications are outstanding for particularly high current gain. Together with BD 643, BD 645, BD 647, and BD 649, they are particularly suitable for use as complementary AF push-pull output stages.

Type	Ordering code
BD 644	Q62702-D230
BD 644/BD 643 paired	Q62702-D235
BD 646	Q62702-D232
BD 646/BD 645 paired	Q62702-D236
BD 648	Q62702-D234
BD 648/BD 647 paired	Q62702-D237
BD 650	Q62702-D375
BD 650/BD 649 paired	Q62702-D376
Insulating nipple	Q62901-B55
Mica washer	Q62901-B52
Spring washer	
A 3 DIN 137	Q62902-B63

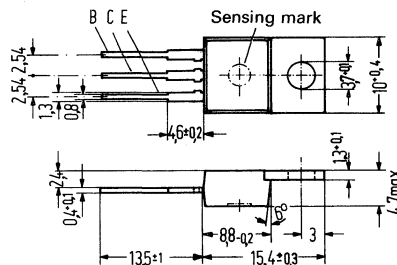
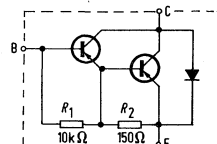

Dimensional drawings in preparation.

Approx. weight 18 g. Dimensions in mm

Maximum ratings		BD 644	BD 646	BD 648	BD 650	
Collector-emitter voltage	$-V_{CEO}$	45	60	80	100	V
Collector-base voltage	$-V_{CBO}$	45	60	80	100	V
Base-emitter voltage	$-V_{EBO}$	5	5	5	5	V
Collector current	$-I_C$	8	8	8	8	A
Collector peak current ($t < 10$ ms)	$-I_{CM}$	12	12	12	12	A
Base current	$-I_B$	150	150	150	150	mA
Storage temperature range	T_{stg}	-55 to +150				°C
Junction temperature	T_j	150	150	150	150	°C
Total power dissipation ($T_{case} \leq 25^\circ\text{C}$, $-V_{CE} \leq 10$ V)	P_{tot}	62,5	62,5	62,5	62,5	W

Thermal resistance

Junction to ambient air	R_{thJA}	≤ 80	≤ 80	≤ 80	≤ 80	K/W
Junction to case ¹⁾	R_{thJC}	≤ 2	≤ 2	≤ 2	≤ 2	K/W

1) For insulated mounting: If the mica washer Q62901-B 52 (50 to 90 μm) and the insulating nipple Q62901-B 55 are used this value increases by 4 K/W, and with grease by 2 K/W.

Static characteristics ($T_{amb} = 25^{\circ}\text{C}$)

		BD 644	BD 646	BD 648	BD 650	
Collector cutoff current ($V_{CB} = V_{CBmax}$)	$-I_{CBO}$	<0.2	<0.2	<0.2	<0.2	mA
($V_{CB} = V_{CBmax}; T_{amb} = 100^{\circ}\text{C}$)	$-I_{CBO}$	<2	<2	<2	<2	mA
Collector cutoff current ($V_{CE} = 0.5 V_{CEmax}$)	$-I_{CEO}$	<0.5	<0.5	<0.5	<0.5	mA
Emitter cutoff current ($V_{EB} = 5\text{ V}$)	$-I_{EBO}$	<5	<5	<5	<5	mA
Collector-emitter breakdown voltage ($I_C = 100\text{ mA}$) ¹⁾	$-V_{(BR)CEO}$	>45	>60	>80	>100	V
Collector-base breakdown voltage ($I_E = 5\text{ mA}$)	$-V_{(BR)CBO}$	>45	>60	>80	>100	V
Emitter-base breakdown voltage ($I_E = 2\text{ mA}$)	$-V_{(BR)EBO}$	>5	>5	>5	>5	V
DC current gain ($-I_C = 0.5\text{ A}; -V_{CE} = 3\text{ V}$)	h_{FE}	1500	1500	1500	1500	–
($-I_C = 3\text{ A}; -V_{CE} = 3\text{ V}$)	h_{FE}	>750	>750	>750	>750	–
($-I_C = 6\text{ A}; -V_{CE} = 3\text{ V}$)	h_{FE}	750	750	750	750	–
Base-emitter forward voltage ($-I_C = 3\text{ A}; -V_{CE} = 3\text{ V}$)	$-V_{BE}$	<2.5	<2.5	<2.5	<2.5	V
Collector-emitter saturation voltage ($-I_C = 3\text{ A}; -I_B = 12\text{ mA}$)	$-V_{CEsat}$	<2	<2	<2	<2	V
Forward voltage of the protective diode at $I_F = 3\text{ A}$	V_F	1.8	1.8	1.8	1.8	V

Dynamic characteristics ($T_{amb} = 25^{\circ}\text{C}$)

Transition frequency ($-I_C = 3\text{ A}; -V_{CE} = 3\text{ V}, f = 1\text{ MHz}$)	f_T	7 (>1)	7 (>1)	7 (>1)	7 (>1)	MHz
Cutoff frequency in common emitter configuration ($-I_C = 3\text{ A}; -V_{CE} = 3\text{ V}$)	f_{hfe}	60	60	60	60	kHz

1) $t = 200\text{ }\mu\text{s}$, duty cycle 1%

BD 644
BD 646
BD 648
BD 650

Total perm. power dissipation versus temperature

$P_{tot} = f(T_{case}); V_{CE} = \text{parameter}$
BD 644, BD 646, BD 648, BD 650

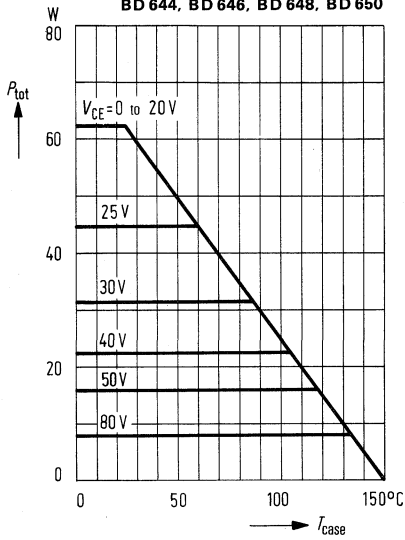

Permissible pulse load

$r_{thJC} = f(t); v = \text{parameter}$
BD 644, BD 646, BD 648, BD 650

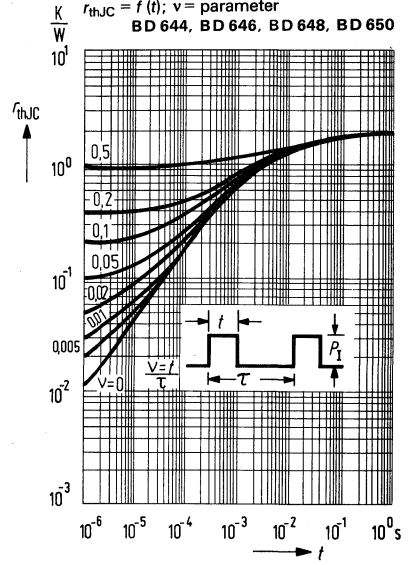

Permissible operating range

$I_C = f(V_{CE}); T_{case} = 25^\circ\text{C}, v = 0.01$
BD 644, BD 646, BD 648, BD 650

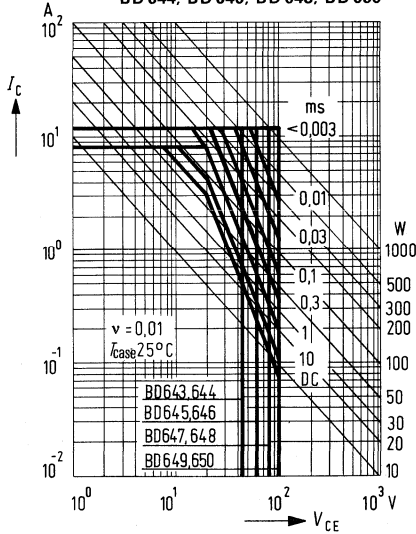

DC current gain $h_{FE} = f(I_C)$

$V_{CE} = 3\text{ V}; T_{case} = 25^\circ\text{C}$
BD 644, BD 646, BD 648, BD 650

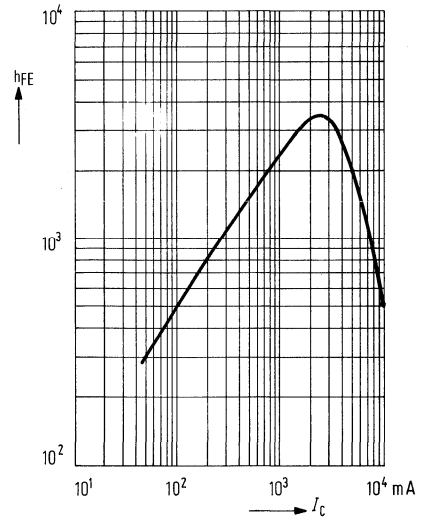

BD 644
BD 646
BD 648
BD 650

Collector current $I_C = f(V_{BE})$
 $-V_{CE} = 3 \text{ V}; T_{\text{case}} = 25^\circ\text{C}$

BD 644, BD 646, BD 648, BD 650

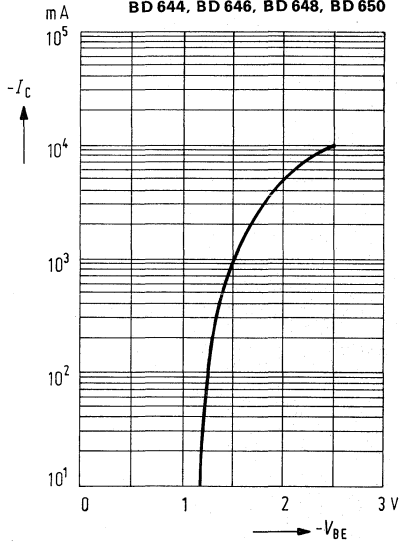

Collector-emitter saturation voltage
 $V_{CE\text{sat}} = f(I_C); h_{FE} = 250; T_{\text{case}} = 25^\circ\text{C}$

BD 644, BD 646, BD 648, BD 650

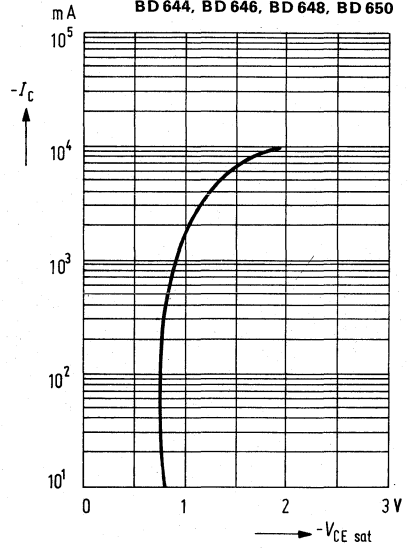

Epibase power darlington transistors (40 W)

BD 675, BD 677, and BD 679 are monolithic NPN silicon epibase power darlington transistors with diode and resistors in a TO 126 plastic package (12 A 3 DIN 41869, sheet 4). The collectors of the two transistors are electrically connected to the metallic mounting area. These darlington transistors for AF applications are outstanding for particularly high current gain. Together with BD 676, BD 678, and BD 680 they are especially suitable for complementary AF push-pull output stages and color TV correction stages.

Type	Ordering code
BD 675	Q62702-D238
BD 677	Q62702-D240
BD 679	Q62702-D242
BD 675/BD 676 paired	Q62702-D244
BD 677/BD 678 paired	Q62702-D245
BD 679/BD 680 paired	Q62702-D246
Mica washer	Q62902-B62
Spring washer	Q62902-B63
A 3 DIN 137	

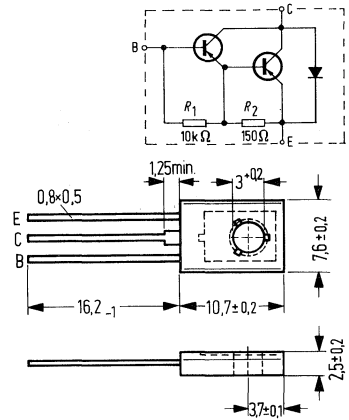

Approx. weight 0.5 g. Dimensions in mm

Maximum ratings

	BD 675	BD 677	BD 679		
Collector-emitter voltage	V_{CE0}	45	60	80	V
Collector-base voltage	V_{CBO}	45	60	80	V
Base-emitter voltage	V_{EBO}	5	5	5	V
Collector current	I_C	4	4	4	A
Collector-peak current ($t \leq 1$ ms)	I_{CM}	7	7	7	A
Base current	I_B	0.1	0.1	0.1	A
Storage temperature range	T_{stg}	-55 to +150		°C	
Junction temperature	T_j	150	150	150	°C
Total power dissipation ($T_{case} \leq 25$ °C; $V_{CE} \leq 20$ V)	P_{tot}	40	40	40	W

Thermal resistance

Junction to ambient air	R_{thJA}	< 100	< 100	< 100	K/W
Junction to case	$R_{thJC}^{1)}$	< 3.12	< 3.12	< 3.12	K/W

1) Transistor fixing with M 3 screw, starting torque $M_A \leq 0.5$ to 0.8 Nm. If a 50 μ mica washer (ungreased) is used, the thermal resistance increases by 8 K/W and in case of a greased one by 4 K/W. Below the screw head, a washer or a spring washer should be used.

Static characteristics ($T_{amb} = 25^{\circ}\text{C}$)

		BD 675	BD 677	BD 679	
Collector cutoff current ($V_{CB} = V_{CBmax}$)	I_{CBO}	<0.2	<0.2	<0.2	mA
($V_{BC} = V_{CBmax}$, $T_{amb} = 100^{\circ}\text{C}$)	I_{CBO}	<2	<2	<2	mA
Collector cutoff current ($V_{CE} = 0.5 V_{CEmax}$)	I_{CEO}	<0.5	<0.5	<0.5	mA
Emitter cutoff current ($V_{EB} = 5\text{ V}$)	I_{EBO}	<5	<5	<5	mA
Collector-emitter breakdown voltage ($I_C = 100\text{ mA}$) ¹⁾	$V_{(BR)CEO}$	>45	>60	>80	V
Collector-base breakdown voltage ($I_C = 1\text{ mA}$)	$V_{(BR)CBO}$	>45	>60	>80	V
Emitter-base breakdown voltage ($I_E = 5\text{ mA}$)	$V_{(BR)EBO}$	>5	>5	>5	V
Collector emitter saturation voltage ($I_C = 50\text{ mA}$; $V_{CE} = 3\text{ V}$)	h_{FE}	750	750	750	–
($I_C = 1.5\text{ A}$; $V_{CE} = 3\text{ V}$)	h_{FE}	>750	>750 (3000)	>750 (3000)	–
($I_C = 4\text{ A}$; $V_{CE} = 3\text{ V}$)	h_{FE}	1000	1000	1000	–
Base-emitter forward voltage ($I_C = 1.5\text{ A}$; $V_{CE} = 3\text{ V}$)	V_{BE}	<2.5	<2.5	<2.5	V
Collector-emitter saturation voltage ($I_C = 1.5\text{ A}$; $I_B = 30\text{ mA}$)	V_{CEsat}	<2.5	<2.5	<2.5	V
Forward voltage of the protective diode at $I_F = 3\text{ A}$	V_F	1.8	1.8	1.8	V

Dynamic characteristics ($T_{amb} = 25^{\circ}\text{C}$)

Transition frequency ($I_C = 1.5\text{ A}$; $V_{CE} = 3\text{ V}$; $f = 1\text{ MHz}$)	f_T	7 (>1)	7 (>1)	7 (>1)	MHz
Cutoff frequency in common emitter configuration ($I_C = 1.5\text{ A}$; $V_{CE} = 3\text{ V}$)	f_{hfe}	60	60	60	kHz

1) $t = 200\text{ }\mu\text{s}$, duty cycle 1%.

Total perm. power dissipation versus temperature

$P_{tot} = f(T_{case}); V_{CE} = \text{parameter}$

BD 675, BD 677

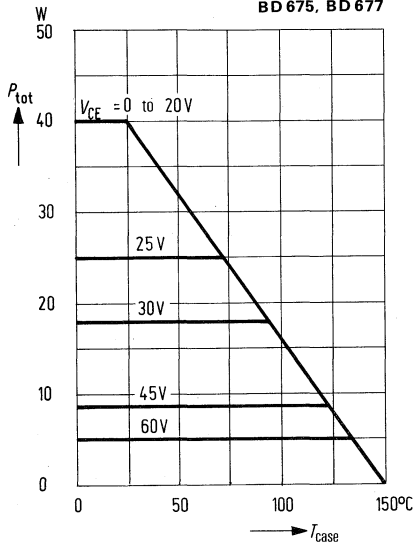

Total perm. power dissipation versus temperature

$P_{tot} = f(T_{case}); V_{CE} = \text{parameter}$

BD 679

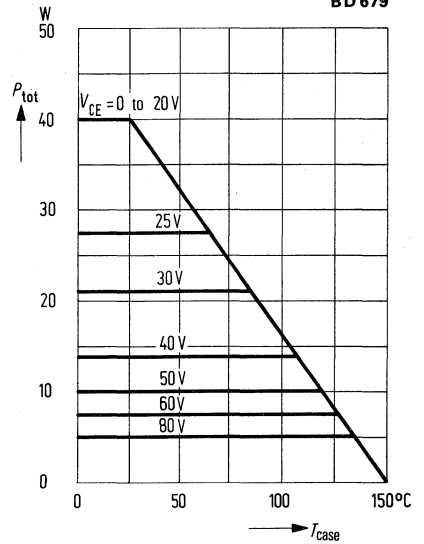

Permissible operating range

$I_C = f(V_{CE}); v = 0.01; T_{case} = 25^\circ\text{C}$

BD 675, BD 677

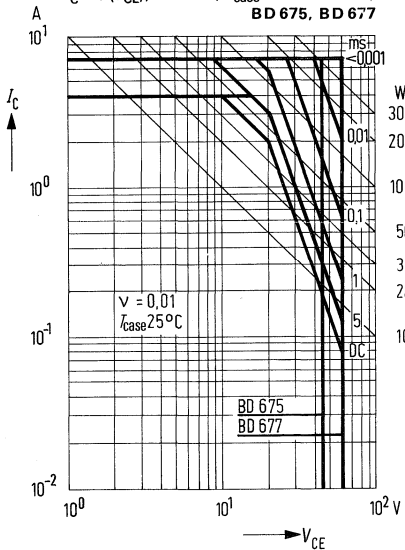

Permissible operating range

$I_C = f(V_{CE}); v = 0.01; T_{case} = 25^\circ\text{C}$

BD 679

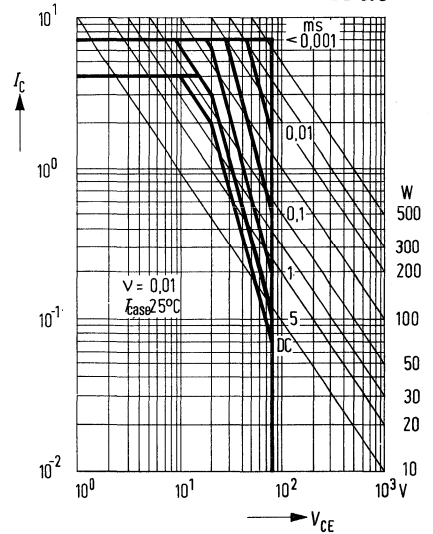

Permissible pulse load
 $t_{thJC} = f(t); v = \text{parameter}$

BD 675, BD 677, BD 679

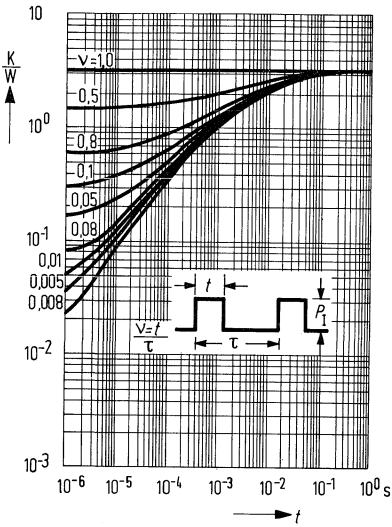

DC current gain $h_{FE} = f(I_C)$

$-V_{CE} = 3V$

BD 675, BD 677, BD 679

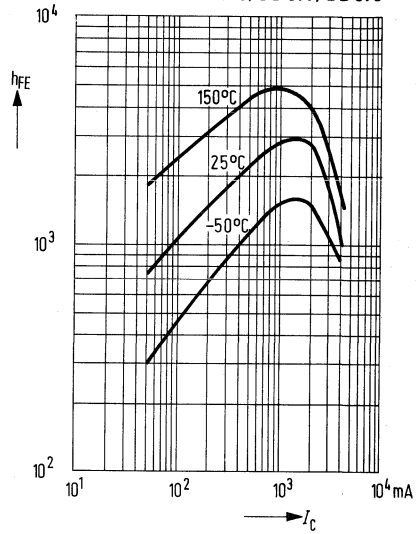

Collector current $I_C = f(V_{BE})$
 $-V_{CE} = 3V; T_{case} = 25^\circ C$

BD 675, BD 677, BD 679

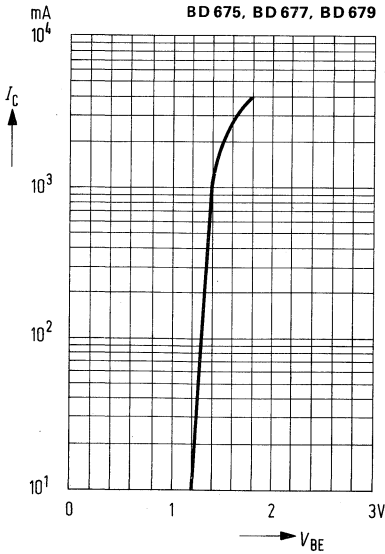

Collector-emitter saturation voltage
 $V_{CEsat} = f(I_C); h_{FE} = 100; T_{case} = 25^\circ C$

BD 675, BD 677, BD 679

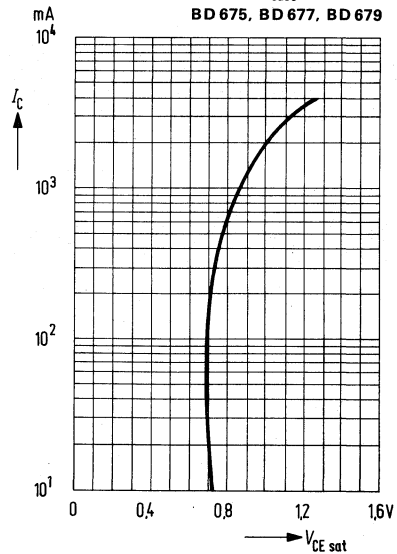

Epibase power darlington transistors (40 W)

BD 676, BD 678, and BD 680 are monolithic PNP silicon epibase power darlington transistors with diode and resistors in a TO 126 plastic package (12 A 3 DIN 41869, sheet 4). The collectors of the two transistors are electrically connected to the metallic mounting area. These darlington transistors for AF applications are outstanding for particularly high current gain. Together with BD 675, BD 677, and BD 679 they are especially suitable for complementary AF push-pull output stages and color TV correction stages.

Type	Ordering code
BD 676	Q62702-D239
BD 678	Q62702-D241
BD 680	Q62702-D243
Bd 676/BD 675 paired	Q62702-D244
BD 678/BD 677 paired	Q62702-D245
BD 680/BD 679 paired	Q62702-D246
Mica washer	Q62902-B62
Spring washer	Q62902-B63
A 3 DIN 137	

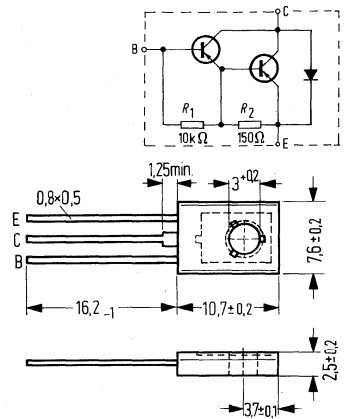

Approx. weight 0.5 g. Dimensions in mm

Maximum ratings

	BD 676	BD 678	BD 680		
Collector-emitter voltage	$-V_{CEO}$	45	60	80	V
Collector-base voltage	$-V_{CBO}$	45	60	80	V
Base-emitter voltage	$-V_{EBO}$	5	5	5	V
Collector current	$-I_C$	4	4	4	A
Collector-peak current ($t \leq 1$ ms)	$-I_{CM}$	7	7	7	A
Base current	$-I_B$	0.1	0.1	0.1	A
Storage temperature range	T_{stg}	-55 to +150		°C	
Junction temperature	T_j	150	150	150	°C
Total power dissipation ($T_{case} \leq 25$ °C; $-V_{CE} \leq 20$ V)	P_{tot}	40	40	40	W

Thermal resistance

Junction to ambient air	$R_{thJA}^{1)}$	<100	<100	<100	K/W
Junction to case	R_{thJC}	<3.12	<3.12	<3.12	K/W

1) Transistor fixing with M 3 screw, starting torque $M_A \leq 0.5$ to 0.8 Nm. If a 50 μ mica washer (ungreased) is used, the thermal resistance increases by 8 K/W and in case of a greased one by 4 K/W. Below the screw head, a washer or a spring washer should be used.

Static characteristics ($T_{amb} = 25^{\circ}\text{C}$)

		BD 676	BD 678	BD 680	
Collector cutoff current ($-V_{CB} = V_{CBmax}$)	$-I_{CBO}$	<0.2	<0.2	<0.2	mA
($-V_{BC} = V_{CBmax}$, $T_{amb} = 100^{\circ}\text{C}$)	$-I_{CBO}$	<2	<2	<2	mA
Collector cutoff current ($-V_{CE} = 0.5 V_{CEmax}$)	$-I_{CEO}$	<0.5	<0.5	<0.5	mA
Emitter cutoff current ($-V_{EB} = 5\text{ V}$)	$-I_{EBO}$	<5	<5	<5	mA
Collector-emitter breakdown voltage ($-I_C = 100\text{ mA}$) ¹⁾	$-V_{(BR)CEO}$	>45	>60	>80	V
Collector-base breakdown voltage ($-I_C = 1\text{ mA}$)	$-V_{(BR)CBO}$	>45	>60	>80	V
Emitter-base breakdown voltage ($I_E = 5\text{ mA}$)	$-V_{(BR)EBO}$	>5	>5	>5	V
DC current gain ($-I_C = 50\text{ mA}$; $-V_{CE} = 3\text{ V}$)	h_{FE}	750	750	750	-
($-I_C = 1.5\text{ A}$; $-V_{CE} = 3\text{ V}$)	h_{FE}	>750	>750(3000)	>750(3000)	-
($-I_C = 4\text{ A}$; $-V_{CE} = 3\text{ V}$)	h_{FE}	1000	1000	1000	-
Base-emitter forward voltage ($-I_C = 1.5\text{ A}$; $-V_{CE} = 3\text{ V}$)	$-V_{BE}$	<2.5	<2.5	<2.5	V
Collector-emitter saturation voltage ($-I_C = 1.5\text{ A}$; $-I_B = 30\text{ mA}$)	$-V_{CEsat}$	<2.5	<2.5	<2.5	V
Forward voltage of the protective diode at $I_F = 3\text{ A}$	V_F	1.8	1.8	1.8	V

Dynamic characteristics ($T_{amb} = 25^{\circ}\text{C}$)

Transition frequency ($-I_C = 2\text{ A}$; $-V_{CE} = 3\text{ V}$; $f = 1\text{ MHz}$)	f_T	>1	>1	>1	MHz
Cutoff frequency in common emitter configuration ($-I_C = 1.5\text{ A}$; $-V_{CE} = 3\text{ V}$)	f_{hfe}	60	60	60	kHz

1) $t = 200\text{ }\mu\text{s}$, duty cycle 1%.

Total perm. power dissipation versus temperature

$P_{tot} = f(T_{case}); V_{CE} = \text{parameter}$

BD 676, BD 678

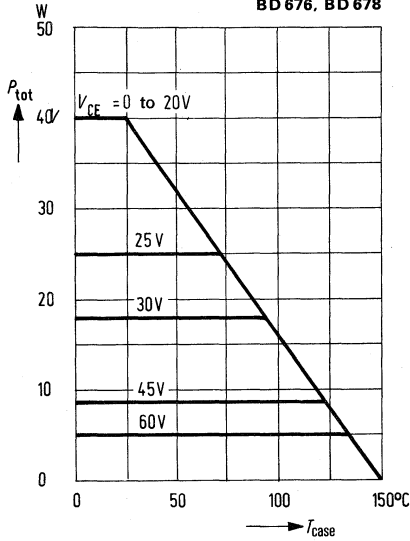

Total perm. power dissipation versus temperature

$P_{tot} = f(T_{case}); V_{CE} = \text{parameter}$

BD 680

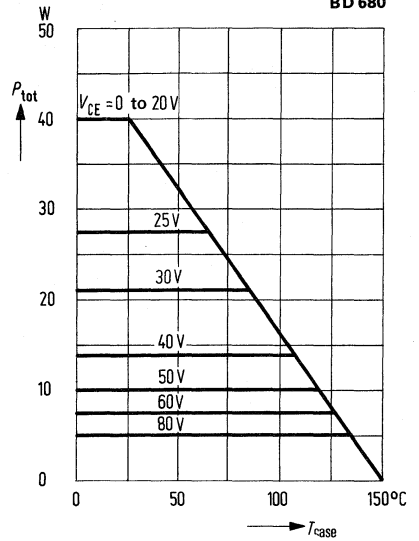

Permissible operating range

$I_C = f(V_{CE}); v = 0.01; T_{case} = 25^\circ\text{C}$

BD 676, BD 678

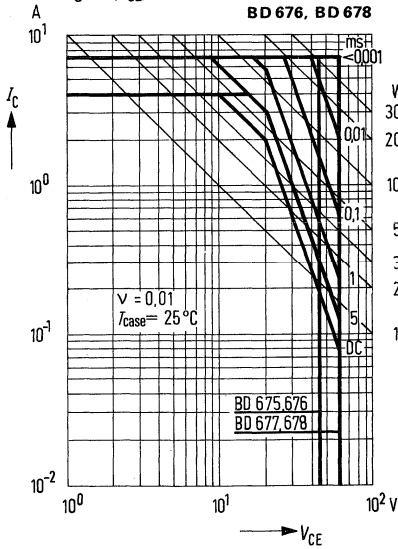

Permissible operating range

$I_C = f(V_{CE}); v = 0.01; T_{case} = 25^\circ\text{C}$

BD 680

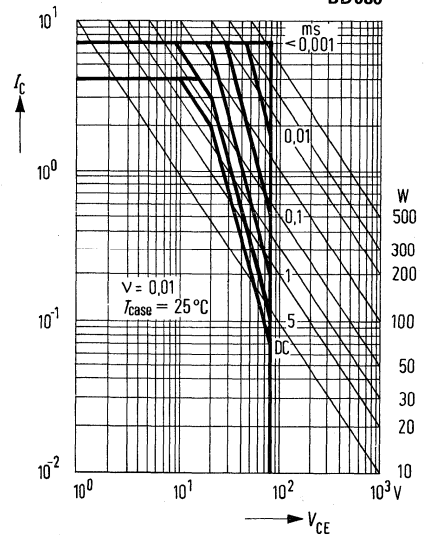

Permissible pulse load
 $r_{thJC} = f(t)$; $v = \text{parameter}$

BD 676, BD 678, BD 680

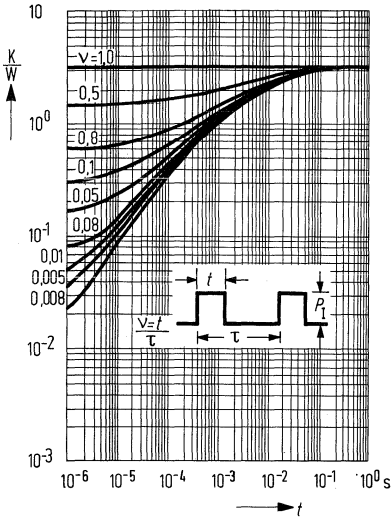

DC current gain $h_{FE} = f(I_C)$
 $-V_{CE} = 3 \text{ V}$

BD 676, BD 678, BD 680

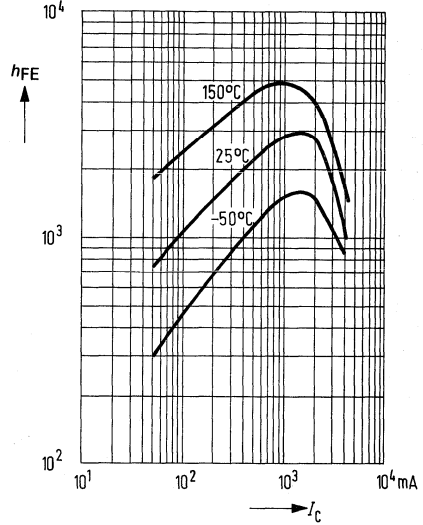

Collector current $I_C = f(V_{BE})$
 $-V_{CE} = 3 \text{ V}; T_{\text{case}} = 25^\circ\text{C}$

BD 676, BD 678, BD 680

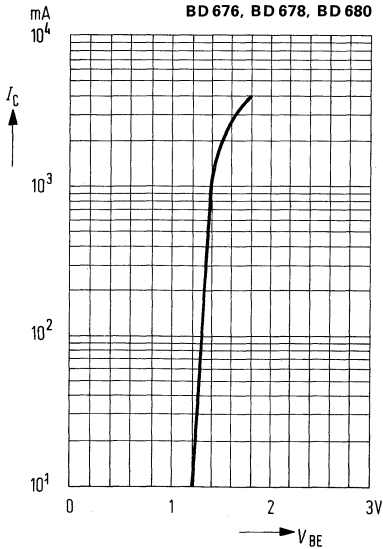

Collector-emitter saturation voltage
 $V_{CE\text{sat}} = f(I_C); h_{FE} = 100; T_{\text{case}} = 25^\circ\text{C}$

BD 676, BD 678, BD 680

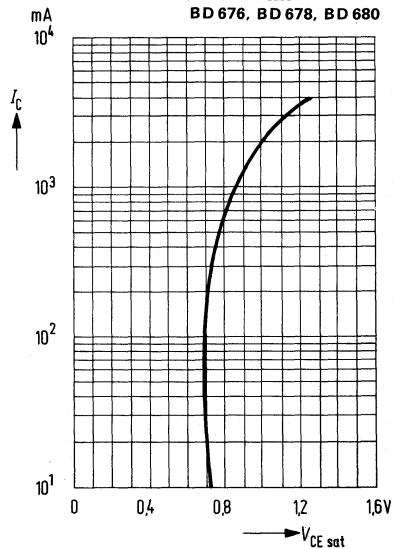

for AF driver and output stages of medium performance

BD 825, BD 827, and BD 829 are epitaxial NPN silicon planar transistors in a plastic case similar to TO 202. The collector is electrically connected to the metallic mounting area of the transistors. In connection with BD 826, BD 828, and BD 830 as complementary transistor pairs, they are particularly suitable for use in driver stages of AF amplifiers of high output power.

Type	Ordering code
BD 825	Q62702-D968
BD 825-6	Q62702-D932
BD 825-10	Q62702-D933
BD 825-16	Q62702-D934
BD 827	Q62702-D970
BD 827-6	Q62702-D938
BD 827-10	Q62702-D939
BD 829	Q62702-D972
BD 829-6	Q62702-D942
BD 829-10	Q62702-D943
BD 825/BD 826 paired	Q62702-D1110
BD 827/BD 828 paired	Q62702-D1111
BD 829/BD 830 paired	Q62702-D1112

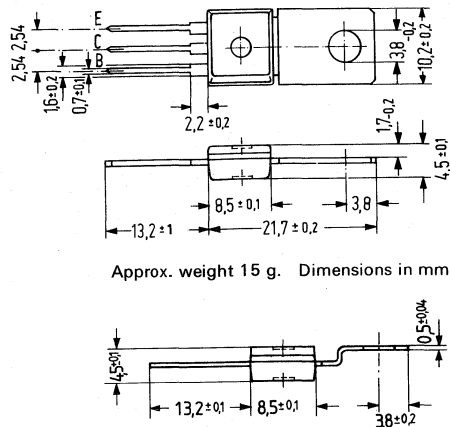

Approx. weight 15 g. Dimensions in mm

Available upon request also with bent fixing plate.

Maximum ratings

Collector-emitter voltage ($R_{BE} \leq 1 \text{ k}\Omega$)	V_{CER}	—	—	100	V
Collector-base voltage	V_{CBO}	45	60	—	V
Collector-emitter voltage	V_{CEO}	45	60	80	V
Emitter-base voltage	V_{EBO}	5	5	5	V
Collector peak current	I_{CM}	2	2	2	A
Collector current	I_C	1.5	1.5	1.5	A
Base current	I_B	0.2	0.2	0.2	A
Junction temperature	T_j	150	150	150	°C
Storage temperature range	T_{stg}	-55 to +125			°C
Total power dissipation ($T_{case} \leq 25^\circ\text{C}$)	P_{tot}	8	8	8	W

	BD 825	BD 827	BD 829	
V_{CER}	—	—	100	V
V_{CBO}	45	60	—	V
V_{CEO}	45	60	80	V
V_{EBO}	5	5	5	V
I_{CM}	2	2	2	A
I_C	1.5	1.5	1.5	A
I_B	0.2	0.2	0.2	A
T_j	150	150	150	°C
T_{stg}	-55 to +125			°C
P_{tot}	8	8	8	W

Thermal resistance

Junction to ambient air	R_{thJA}	≤ 62.5	≤ 62.5	≤ 62.5	K/W
Junction to case bottom	R_{thJC}	≤ 15	≤ 15	≤ 15	K/W

Static characteristics ($T_{amb} = 25^{\circ}\text{C}$)

The transistors BD 825, BD 827, and BD 829 are grouped at $V_{CE} = 2\text{ V}$ according to the DC current gain h_{FE} and are designated by numerals (6, 10, 16) of the German DIN standard.

h_{FE} group	6	10	16	
Type	BD 825 BD 827 BD 829	BD 825 BD 827 BD 829	BD 825 – –	BD 825 BD 827 BD 829
I_C (mA)	h_{FE} I_C/I_B	h_{FE} I_C/I_B	h_{FE} I_C/I_B	V_{BE} (V)
5	>25	>25	25	–
150	63 (40 to 100)	100 (63 to 160)	160 (100 to 250)	–
500	>25	>25	>25	1.2

Static characteristics ($T_{amb} = 25^{\circ}\text{C}$)

	BD 825	BD 827	BD 829		
Collector-emitter saturation voltage ($I_C = 500\text{ mA}$; $I_B = 50\text{ mA}$)	V_{CEsat}	<0.5	<0.5	<0.5	V
Collector cutoff current ($V_{CB} = 30\text{ V}$)	I_{CBO}	<100	<100	<100	nA
Collector cutoff current ($V_{CB} = 30\text{ V}$; $T_{amb} = 125^{\circ}\text{C}$)	I_{CBO}	≤ 10	≤ 10	≤ 10	μA
Emitter cutoff current ($V_{EB} = 5\text{ V}$)	I_{EBO}	≤ 10	≤ 10	≤ 10	μA
Collector-emitter breakdown voltage ($I_{CEO} = 50\text{ mA}$)	$V_{(BR)CEO}$	>45	>60	>80	V
Condition for matching pairs ($I_C = 150\text{ mA}$; $V_{CE} = 2\text{ V}$)	$\frac{h_{FE1}}{h_{FE2}}$	≤ 1.41	≤ 1.41	≤ 1.41	–

Dynamic characteristics ($T_{amb} = 25^{\circ}\text{C}$)

Transition frequency ($I_C = 50\text{ mA}$; $V_{CE} = 10\text{ V}$; $f = 100\text{ MHz}$)	f_T	>50	>50	>50	MHz
--	-------	-----	-----	-----	-----

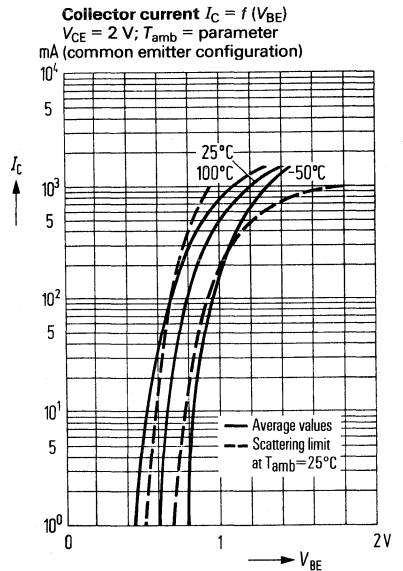
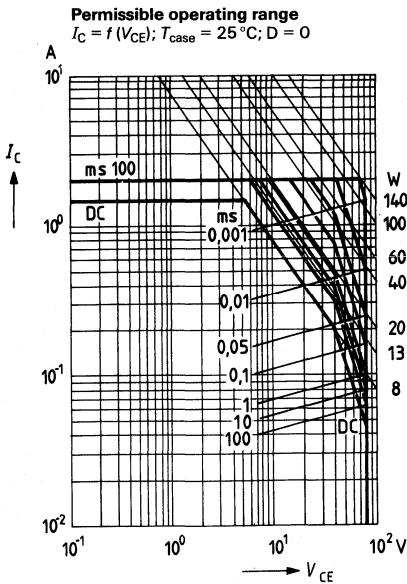
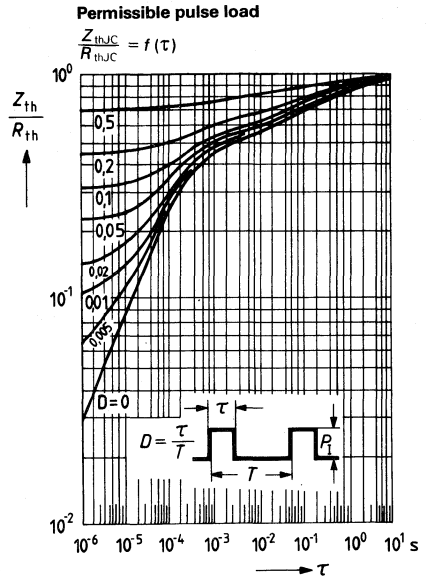
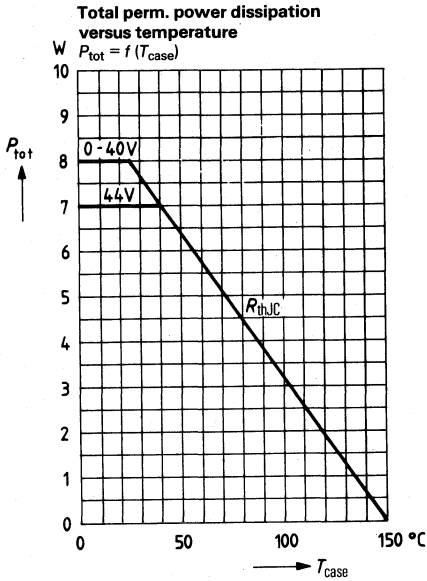

**BD 825
BD 827
BD 829**

DC current gain $h_{FE} = f(I_C)$
 $V_{CE} = 2\text{ V}; T_{amb} = \text{parameter}$

BD 825-10, BD 827-10, BD 829-10

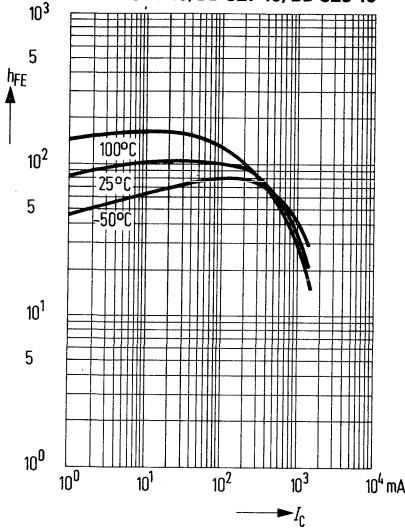

Collector cutoff current versus temperature $I_{CBO} = f(T_{amb})$

BD 825, BD 827, BD 829

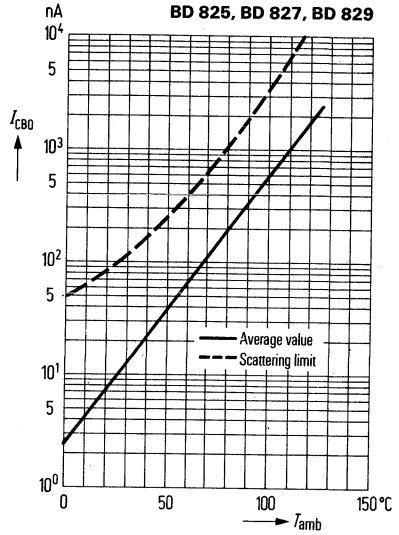

Collector-emitter saturation voltage

$V_{CEsat} = f(I_C)$
 $h_{FE} = 10; T_{amb} = \text{parameter}$
 (common emitter configuration)

BD 825, BD 827, BD 829

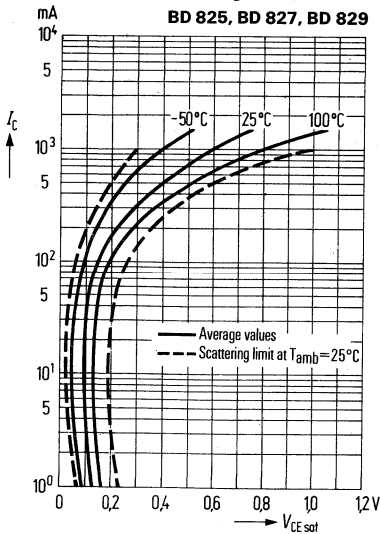

Base-emitter saturation voltage

$V_{BEsat} = f(I_C)$
 $h_{FE} = 10; T_{amb} = \text{parameter}$
 (common emitter configuration)

BD 825, BD 827, BD 829

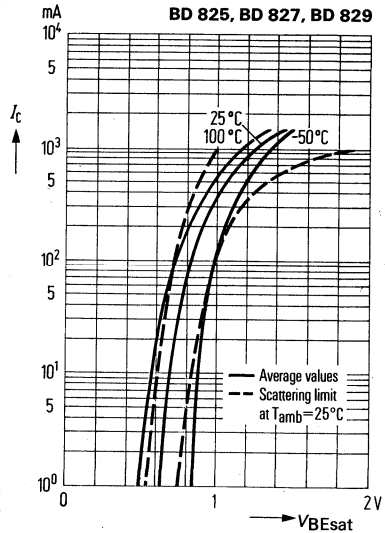

Output characteristics $I_C = f(V_{CE})$
 $I_B = \text{parameter}$

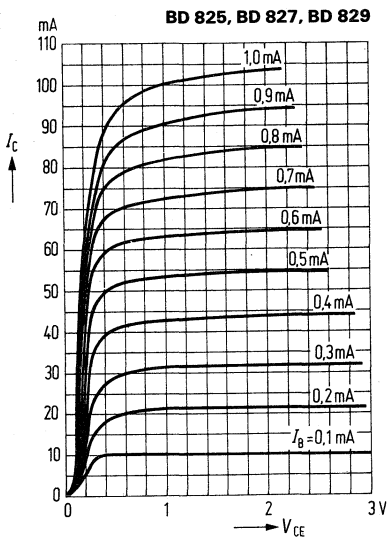

Output characteristics $I_C = f(V_{CE})$
 $I_B = \text{parameter}$

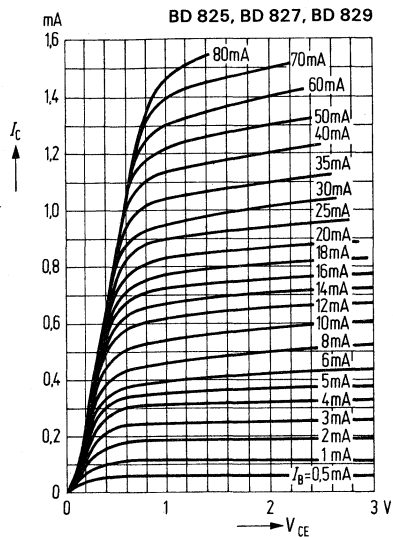

Output characteristics $I_C = f(V_{CE})$
 $I_B = \text{parameter}$

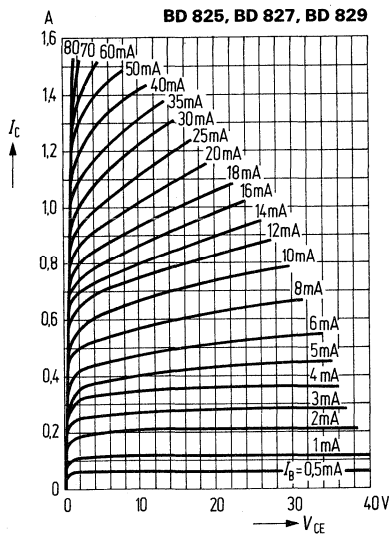

Transition frequency $f_T = f(I_C)$
 $(V_{CE} = 10 \text{ V})$

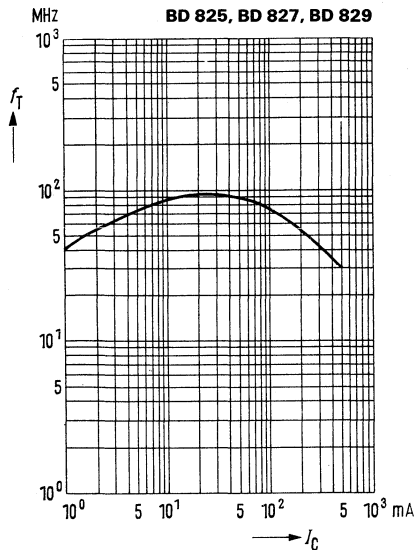

for AF driver and output stages of medium performance

BD 826, BD 828, and BD 830 are epitaxial PNP silicon planar transistors in a plastic case similar to TO 202. The collector is electrically connected to the metallic mounting area of the transistors. In connection with BD 825, BD 827, and BD 829 as complementary transistor pairs, they are particularly suitable for use in driver stages of AF amplifiers of high output power.

Type	Ordering code
BD 826	Q62702-D969
BD 826-6	Q62702-D935
BD 826-10	Q62702-D936
BD 826-16	Q62702-D937
BD 828	Q62702-D971
BD 828-6	Q62702-D940
BD 828-10	Q62702-D941
BD 830	Q62702-D973
BD 830-6	Q62702-D944
BD 830-10	Q62702-D945
BD 826/BD 825 paired	Q62702-D1110
BD 828/BD 827 paired	Q62702-D1111
BD 830/BD 829 paired	Q62702-D1112

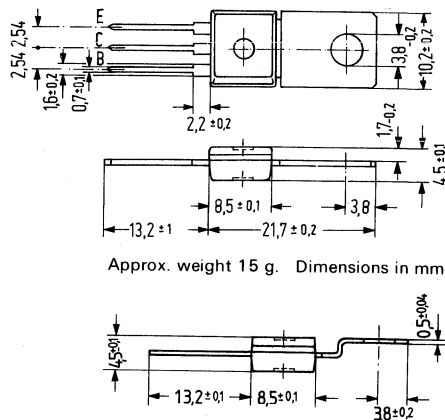

Available upon request also with bent fixing plate.

Maximum ratings

	BD 826	BD 828	BD 830	
Collector-emitter voltage ($R_{BE} \leq 1 \text{ k}\Omega$)	-	-	100	V
Collector-base voltage	45	60	-	V
Collector-emitter voltage	45	60	80	V
Emitter-base voltage	5	5	5	V
Collector peak current	2	2	2	A
Collector current	1.5	1.5	1.5	A
Base current	0.2	0.2	0.2	A
Junction temperature	150	150	150	°C
Storage temperature range		-55 to +125		°C
Total power dissipation ($T_{\text{case}} \leq 25^\circ\text{C}$)	8	8	8	W

Thermal resistance

Junction to ambient air	R_{thJA}	≤ 62.5	≤ 62.5	≤ 62.5	K/W
Junction to case bottom	R_{thJC}	≤ 15	≤ 15	≤ 15	K/W

Static characteristics ($T_{amb} = 25^{\circ}\text{C}$)

The transistors BD 826, BD 828, and BD 830 are grouped at $-V_{CE} = 2\text{ V}$ according to the DC current gain h_{FE} , and marked by numerals of the German DIN standard.

h_{FE} group	6	10	16	
Type	BD 826 BD 828 BD 830	BD 826 BD 828 BD 830	BD 826 – –	BD 826 BD 828 BD 830
$-I_C$ (mA)	h_{FE} I_C/I_B	h_{FE} I_C/I_B	h_{FE} I_C/I_B	$-V_{BE}$ (V)
5	> 25	> 25	> 25	–
150	63 (40 to 100)	100 (63 to 160)	160 (100 to 250)	–
500	> 25	> 25	> 25	1.2

Static characteristics ($T_{amb} = 25^{\circ}\text{C}$)

	BD 826	BD 828	BD 830	
Collector-emitter saturation voltage ($-I_C = 500\text{ mA}$; $-I_B = 50\text{ mA}$)	$-V_{CEsat}$ < 0.5	< 0.5	< 0.5	V
Collector cutoff current ($-V_{CB} = 30\text{ V}$)	$-I_{CBO}$ < 100	< 100	< 100	nA
Collector cutoff current ($-V_{CB} = 30\text{ V}$; $T_{amb} = 125^{\circ}\text{C}$)	$-I_{CBO}$ \leq 10	\leq 10	\leq 10	μA
Emitter cutoff current ($-V_{EB} = 5\text{ V}$)	$-I_{EBO}$ \leq 10	\leq 10	\leq 10	μA
Collector-emitter breakdown voltage ($-I_{CEO} = 50\text{ mA}$)	$-V_{(BR)CEO}$ > 45	> 60	> 80	V
Condition for matching pairs ($-I_C = 150\text{ mA}$; $-V_{CE} = 2\text{ V}$)	$\frac{h_{FE1}}{h_{FE2}}$ \leq 1.41	\leq 1.41	\leq 1.41	–

Dynamic characteristics ($T_{amb} = 25^{\circ}\text{C}$)

Transition frequency ($-I_C = 50\text{ mA}$; $-V_{CE} = 10\text{ V}$; $f = 100\text{ MHz}$)	f_T	> 50	> 50	> 50	MHz
---	-------	------	------	------	-----

Total perm. power dissipation versus temperature
 $P_{tot} = f(T_{case})$

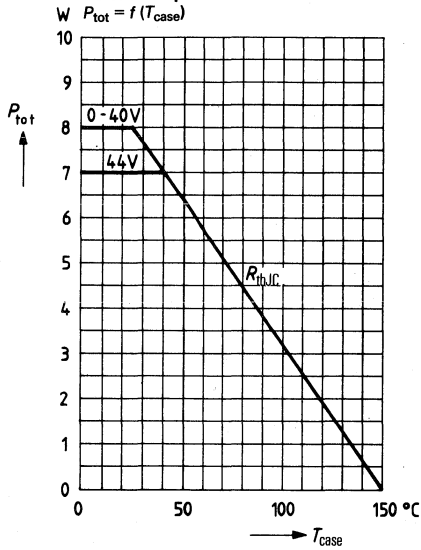

Permissible pulse load

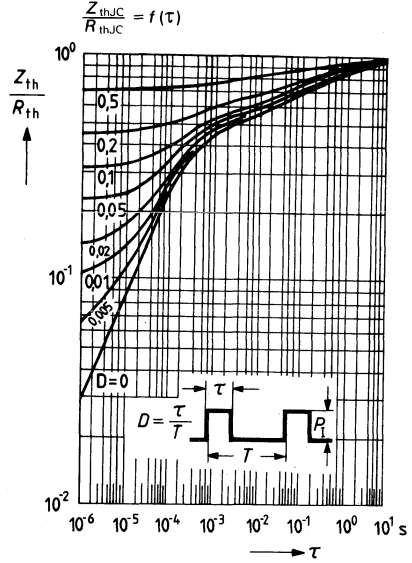

Permissible operating range
 $I_C = f(V_{CE}); T_{case} = 25^\circ\text{C}; D = 0$

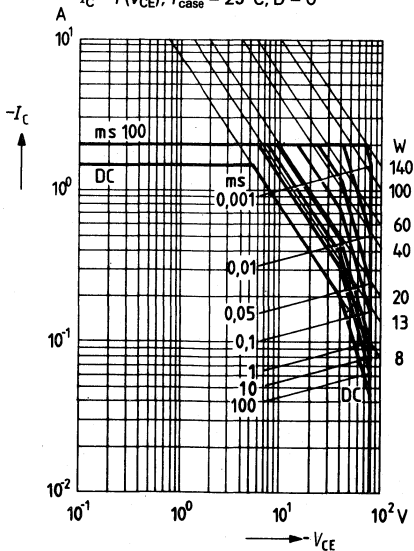

Collector current $I_C = f(V_{BE})$
 $V_{CE} = 2\text{ V}; T_{amb} = \text{parameter}$
(common emitter configuration)

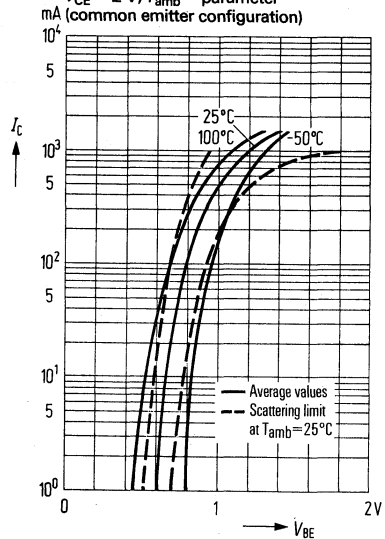

DC current gain $h_{FE} = f(I_C)$
 $V_{CE} = 2\text{ V}; T_{amb} = \text{parameter}$

BD 826-10, BD 828-10, BD 830-10

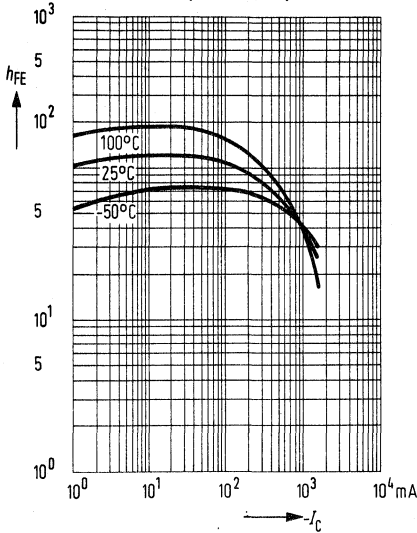

Collector cutoff current versus temperature $I_{CBO} = f(T_{amb})$

BD 826, BD 828, BD 830

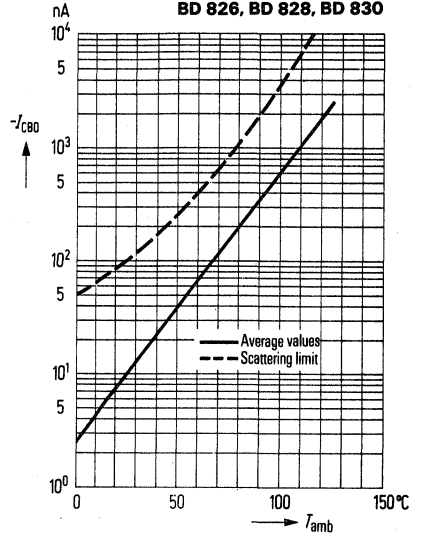

Collector-emitter saturation voltage

$V_{CEsat} = f(I_C)$
 $h_{FE} = 10; T_{amb} = \text{parameter}$
 (common emitter configuration)

BD 826, BD 828, BD 830

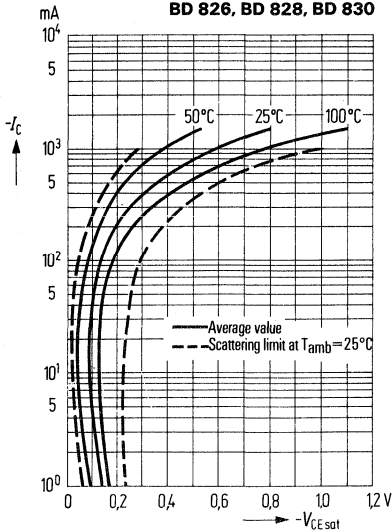

Base-emitter saturation voltage

$V_{BEsat} = f(I_C)$
 $h_{FE} = 10; T_{amb} = \text{parameter}$
 (common emitter configuration)

BD 826, BD 828, BD 830

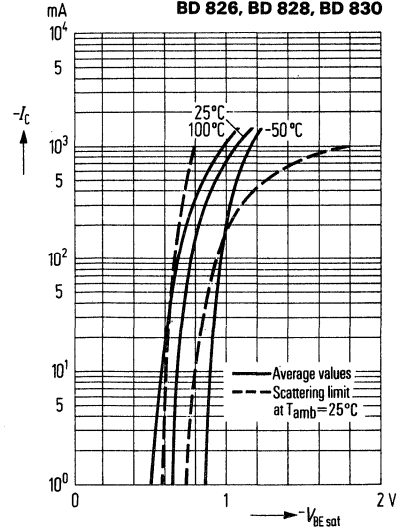

BD 826
BD 828
BD 830

Output characteristics $I_C = f(V_{CE})$
 $I_B = \text{parameter}$

BD 826, BD 828, BD 830

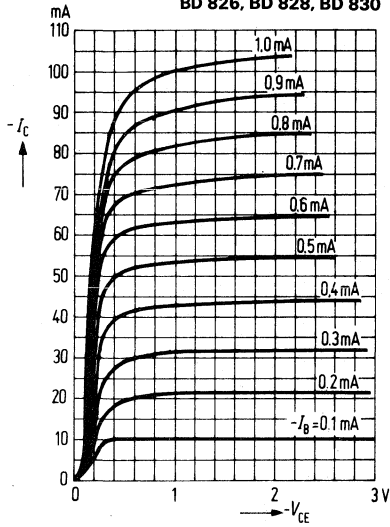

Output characteristics $I_C = f(V_{CE})$
 $I_B = \text{parameter}$

BD 826, BD 828, BD 830

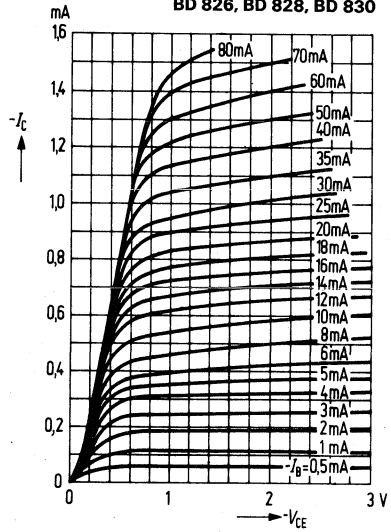

Output characteristics $I_C = f(V_{CE})$
 $I_B = \text{parameter}$

BD 826, BD 828, BD 830

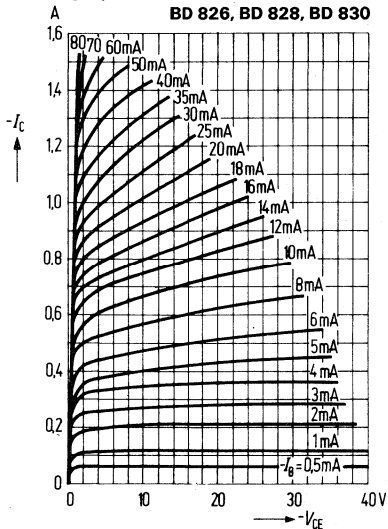

Transition frequency $f_T = f(I_C)$
 $-V_{CE} = 10 \text{ V}$

BD 826, BD 828, BD 830

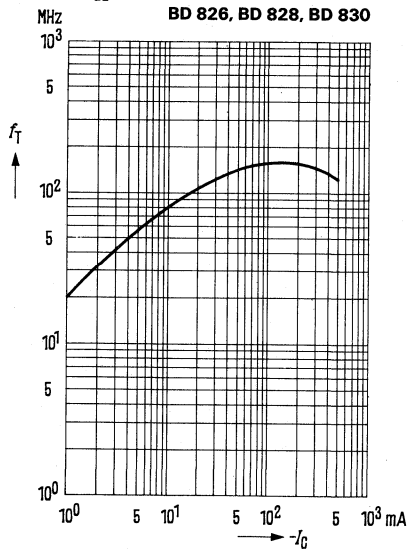

Epibase power darlington transistors (15 W)

BD 861, BD 863, and BD 865 are monolithic silicon NPN epibase power darlington transistors with diode and resistors in a plastic package similar to TO 202. The collectors of the two transistors are electrically connected to the metallic mounting area. These darlington transistors for AF applications are outstanding for a particularly high current gain. Together with BD 862, BD 864, and BD 866, they are especially useful as complementary AF push-pull output stages for color TV correction stages.

Type	Ordering code
BD 861	Q62702-D956
BD 863	Q62702-D958
BD 865	Q62702-D960

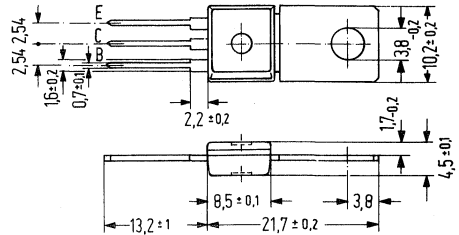

Approx. weight 15 g. Dimensions in mm

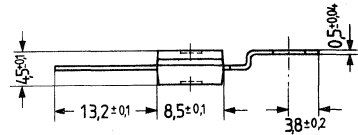

Available upon request also with bent fixing plate.

Maximum ratings

	BD 861	BD 863	BD 865	
Collector-emitter voltage	45	60	80	V
Collector-base voltage	45	60	80	V
Base-emitter voltage	5	5	5	V
Collector current	4	4	4	A
Collector peak current ($t \leq 1$ ms)	7	7	7	A
Base current	0.1	0.1	0.1	A
Storage temperature range	-55 to +150			°C
Junction temperature	150	150	150	°C
Total power dissipation ($T_{\text{case}} \leq 25$ °C)	15	15	15	W

Thermal resistance

Junction to ambient air	R_{thJA}	62.5	62.5	62.5	K/W
Junction to case	R_{thJC}	8.3	8.3	8.3	K/W

Static characteristics ($T_{amb} = 25^{\circ}\text{C}$)

		BD 861	BD 863	BD 865	
Collector cutoff current ($V_{CB} = V_{CBmax}$)	I_{CBO}	<0.2	<0.2	<0.2	mA
($V_{BC} = V_{CBmax}$; $T_{amb} = 100^{\circ}\text{C}$)	I_{CBO}	<2	<2	<2	mA
Collector cutoff current ($V_{CE} = 0.5 V_{CEmax}$)	I_{CEO}	<0.5	<0.5	<0.5	mA
Emitter cutoff current ($V_{EBO} = 5\text{ V}$)	I_{EBO}	<5	<5	<5	mA
Collector-emitter breakdown voltage ($I_C = 100\text{ mA}$)	$V_{(BR)CEO}$	>45	>60	>60	V
Collector-base breakdown voltage ($I_C = 1\text{ mA}$)	$V_{(BR)CBO}$	>45	>60	>80	V
Emitter-base breakdown voltage ($I_E = 5\text{ mA}$)	$V_{(BR)EBO}$	>5	>5	>5	V
DC current gain ($I_C = 50\text{ mA}$; $V_{CE} = 3\text{ V}$)	h_{FE}	750	750	750	–
($I_C = 1.5\text{ A}$; $V_{CE} = 3\text{ V}$)	h_{FE}	>750	>750 (3000)	>750 (3000)	–
($I_C = 4\text{ A}$; $V_{CE} = 3\text{ V}$)	h_{FE}	1000	1000	1000	–
Base-emitter forward voltage ($I_C = 1.5\text{ A}$; $V_{CE} = 3\text{ V}$)	V_{BE}	<2.5	<2.5	<2.5	V
Collector-emitter saturation voltage ($I_C = 1.5\text{ A}$; $I_B = 30\text{ mA}$)	V_{CEsat}	<2.5	<2.5	<2.5	V
Forward voltage of the protective diode at $I_F = 3\text{ A}$	V_F	1.8	1.8	1.8	V

Dynamic characteristics ($T_{amb} = 25^{\circ}\text{C}$)

Transition frequency ($I_C = 1.5\text{ A}$; $V_{CE} = 3\text{ V}$; $f = 1\text{ MHz}$)	f_T	7 (>1)	7 (>1)	7 (>1)	MHz
Cutoff frequency in common emitter emitter configuration ($I_C = 1.5\text{ A}$; $V_{CE} = 3\text{ V}$)	f_{hfe}	60	60	60	kHz

Total perm. power dissipation versus temperature
 $P_{tot} = f(T); V_{CE} = \text{parameter}$

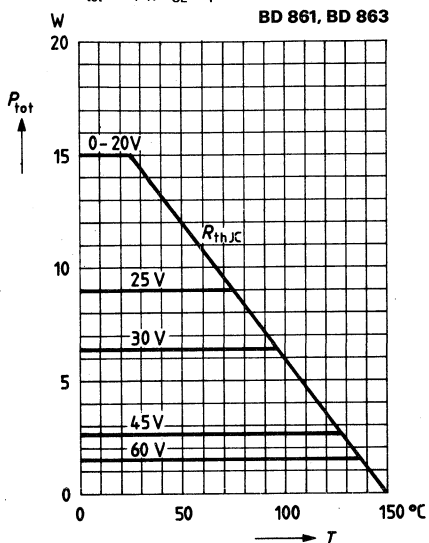

Total perm. power dissipation versus temperature
 $P_{tot} = f(T); V_{CE} = \text{parameter}$

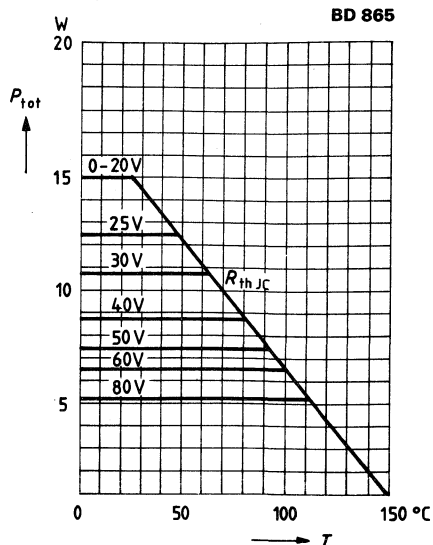

Permissible operating range
 $I_C = f(V_{CE}); T_{case} \leq 25^\circ\text{C}; D = 0.01$

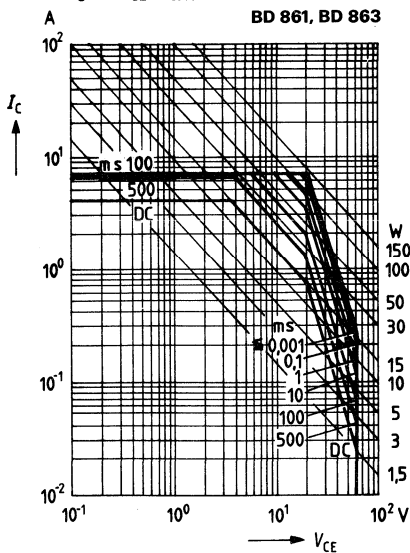

Permissible operating range
 $I_C = f(V_{CE}); T_{case} \leq 25^\circ\text{C}; D = 0.01$

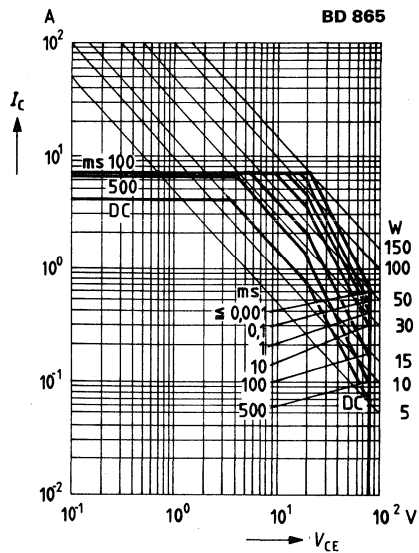

Permissible pulse load

$$\frac{Z_{thJC}}{R_{thJC}} = f(\tau)$$

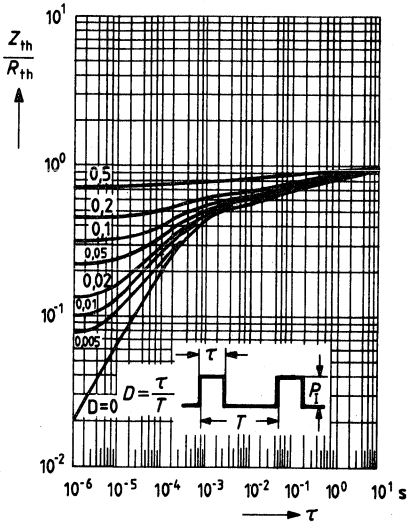

Epibase power darlington transistors (15 W)

BD 862, BD 864, and BD 866 are monolithic silicon PNP epibase power darlington transistors with diode and resistors in a plastic package similar to TO 202. The collectors of the two transistors are electrically connected to the metallic mounting area. These darlington transistors for AF applications are outstanding for a particularly high current gain. Together with BD 861, BD 863, and BD 865, they are especially useful as complementary AF push-pull output stages for color TV correction stages.

Type	Ordering code
BD 862	Q62702-D957
BD 864	Q62702-D959
BD 866	Q62702-D961

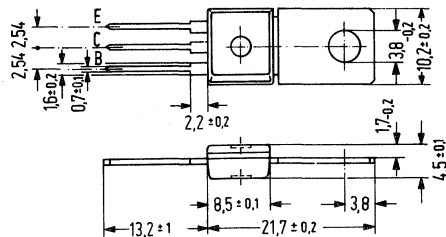

Approx. weight 15 g. Dimensions in mm

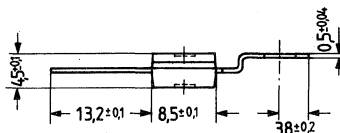

Available upon request also with bent fixing plate.

Maximum ratings

	BD 862	BD 864	BD 866		
Collector-emitter voltage	-V _{CEO}	45	60	80	V
Collector-base voltage	-V _{CBO}	45	60	80	V
Base-emitter voltage	-V _{EBO}	5	5	5	V
Collector current	-I _C	4	4	4	A
Collector peak current (t ≤ 1 ms)	-I _{CM}	7	7	7	A
Base current	-I _B	0.1	0.1	0.1	A
Storage temperature range	T _{stg}	-55 to +150			°C
Junction temperature	T _j	150	150	150	°C
Total power dissipation (T _{case} ≤ 25 °C)	P _{tot}	15	15	15	W

Thermal resistance

Junction to ambient air	R _{thJA}	62.5	62.5	62.5	K/W
Junction to case	R _{thJC}	8.3	8.3	8.3	K/W

Static characteristics ($T_{amb} = 25^{\circ}\text{C}$)		BD 862	BD 864	BD 866	
Collector cutoff current ($V_{CB} = V_{CBmax}$)	$-I_{CBO}$	<0.2	<0.2	<0.2	mA
($V_{BC} = V_{CBmax}$, $T_{amb} = 100^{\circ}\text{C}$)	$-I_{CBO}$	<2	<2	<2	mA
Collector cutoff current ($-V_{CE} = 0.5 V_{CEmax}$)	$-I_{CEO}$	<0.5	<0.5	<0.5	mA
Emitter cutoff current ($-V_{EBO} = 5 \text{ V}$)	$-I_{EBO}$	<5	<5	<5	mA
Collector-emitter breakdown voltage ($-I_C = 100 \text{ mA}$)	$-V_{(BR)CEO}$	>45	>60	>80	V
Collector-base breakdown voltage ($-I_C = 1 \text{ mA}$)	$-V_{(BR)CBO}$	>45	>60	>80	V
Emitter-base breakdown voltage ($I_E = 5 \text{ mA}$)	$-V_{(BR)EBO}$	>5	>5	>5	V
DC current gain ($-I_C = 50 \text{ mA}$; $-V_{CE} = 3 \text{ V}$)	h_{FE}	750	750	750	-
($-I_C = 1.5 \text{ A}$; $-V_{CE} = 3 \text{ V}$)	h_{FE}	>750	>750 (3000)	>750 (3000)	-
($-I_C = 4 \text{ A}$; $-V_{CE} = 3 \text{ V}$)	h_{FE}	1000	1000	1000	-
Base-emitter forward voltage ($-I_C = 1.5 \text{ A}$; $-V_{CE} = 3 \text{ V}$)	$-V_{BE}$	<2.5	<2.5	<2.5	V
Collector-emitter saturation voltage ($-I_C = 1.5 \text{ A}$; $-I_B = 30 \text{ mA}$)	$-V_{CEsat}$	<2.5	<2.5	<2.5	V
Forward voltage of the protective diode at $I_F = 3 \text{ A}$	V_F	1.8	1.8	1.8	V

Dynamic characteristics ($T_{amb} = 25^{\circ}\text{C}$)

Transition frequency ($-I_C = 1.5 \text{ A}$; $-V_{CE} = 3 \text{ V}$; $f = 1 \text{ MHz}$)	f_T	7 (>1)	7 (>1)	7 (>1)	MHz
Cutoff frequency in common emitter configuration ($-I_C = 1.5 \text{ A}$; $-V_{CE} = 3 \text{ V}$)	f_{hfe}	60	60	60	kHz

Total perm. power dissipation versus temperature

$P_{tot} = f(T_{case}); V_{CE} = \text{parameter}$

BD 862, BD 864

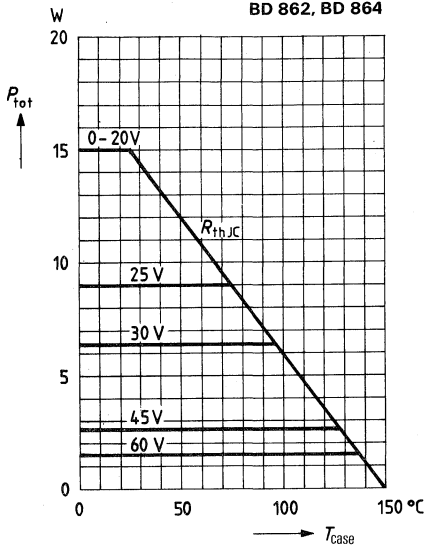

Total perm. power dissipation versus temperature

$P_{tot} = f(T_{case}); V_{CE} = \text{parameter}$

BD 866

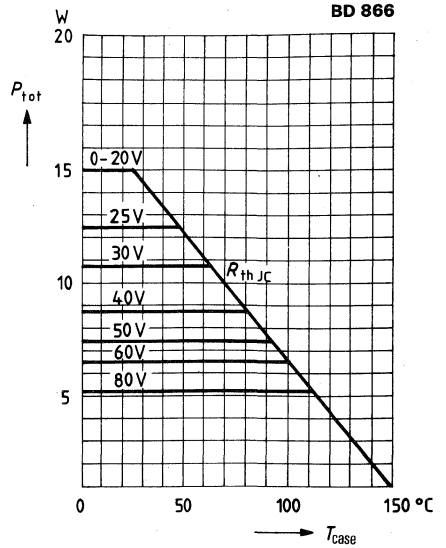

Permissible operating range

$I_C = f(V_{CE}); T_{case} \leq 25^\circ\text{C}; D = 0.01$

BD 862, BD 864

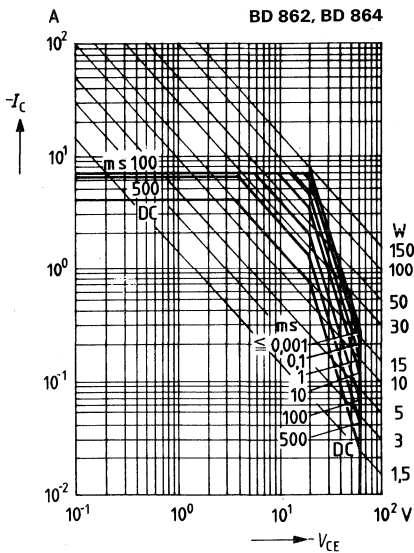

Permissible operating range

$I_C = f(V_{CE}); T_{case} \leq 25^\circ\text{C}; D = 0.01$

BD 866

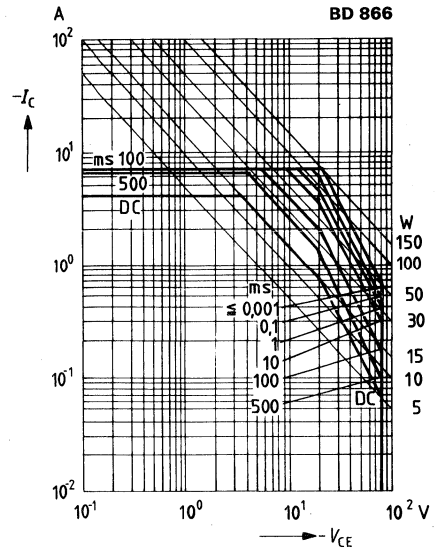

Permissible pulse load

$$\frac{Z_{thJC}}{R_{thJC}} = f(\tau)$$

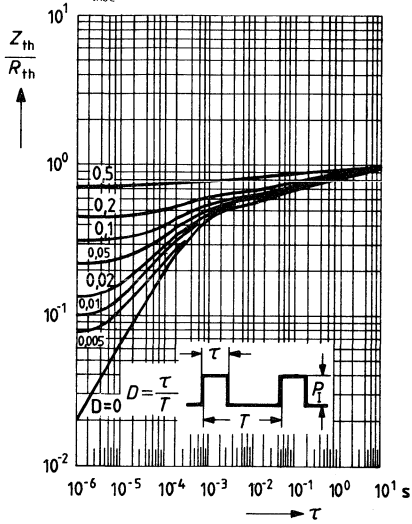

NPN Silicon Planar Darlington Transistors

BD 875
BD 877
BD 879

BD 875, BD 877, and BD 879 are epitaxial NPN silicon planar darlington transistors in TO 126 plastic package (12 A 3 DIN 41869, sheet 4). These darlington transistors are designed for relay drivers as well as for general AF applications. BD 876, BD 878, and BD 880 are provided as complementary transistors.

Type	Ordering code
BD 875	Q62702-D902
BD 877	Q62702-D903
BD 879	Q62702-D904
Spring washer A 3 DIN 137	Q62902-B63
Mica washer	Q62902-B62

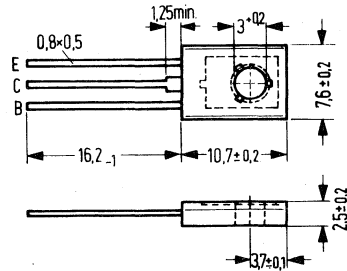
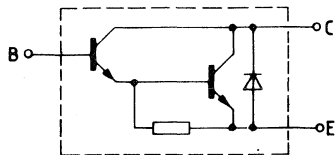

Approx. weight 0.5 g Dimensions in mm

Transistor fixing with M 3 screw; starting torque max. 0.8 Nm; washer or spring washer should be used.

Maximum ratings ($T_{amb} = 25^{\circ}\text{C}$)

Collector-emitter voltage
Collector-base voltage
Emitter-base voltage
Collector current
Collector peak current
Base current
Junction temperature
Storage temperature range
Total power dissipation
($T_{amb} \leq 25^{\circ}\text{C}$)
($T_{case} \leq 60^{\circ}\text{C}$)

	BD 875	BD 877	BD 879	
V_{CEO}	45	60	80	V
V_{CBO}	60	80	100	V
V_{EBO}	5	5	5	V
I_C	1	1	1	A
I_{CM}	2	2	2	A
I_B	0.1	0.1	0.1	A
T_j	150	150	150	$^{\circ}\text{C}$
T_{stg}	-65 to +150			$^{\circ}\text{C}$
P_{tot}	1.25	1.25	1.25	W
P_{tot}	9	9	9	W

Thermal resistance

Junction to ambient air
Junction to case

R_{thJA}	<100	<100	<100	K/W
R_{thJC}	<10	<10	<10	K/W

Static characteristics ($T_{amb} = 25^{\circ}\text{C}$)		BD 875	BD 877	BD 879	
Collector cutoff current ($V_{CB} = V_{CBmax}$)	I_{CBO}	<100	<100	<100	nA
Collector cutoff current ($V_{CE} = 0.5 V_{CEmax}$)	I_{CEO}	<500	<500	<500	nA
Emitter cutoff current ($V_{EB} = 4\text{ V}$)	I_{EBO}	<100	<100	<100	nA
Collector-emitter breakdown voltage ($I_C = 50\text{ mA}$)	$V_{(BR)CEO}$	>45	>60	>80	V
Collector-base breakdown voltage ($I_C = 100\text{ }\mu\text{A}$)	$V_{(BR)CBO}$	>60	>80	>100	V
Emitter-base breakdown voltage ($I_E = 100\text{ }\mu\text{A}$)	$V_{(BR)EBO}$	>5	>5	>5	V
DC current gain ($I_C = 150\text{ mA}$; $V_{CE} = 10\text{ V}$)	h_{FE}	>1000	>1000	>1000	-
($I_C = 0.5\text{ A}$; $V_{CE} = 10\text{ V}$)	h_{FE}	>2000	>2000	>2000	-
Collector-emitter saturation voltage ($I_C = 0.5\text{ A}$; $I_B = 0.5\text{ mA}$)	V_{CEsat}	<1.3	<1.3	<1.3	V
($I_C = 1\text{ A}$; $I_B = 1\text{ mA}$)	V_{CEsat}	<1.8	<1.8	<1.8	V
Base-emitter saturation voltage ($I_C = 1\text{ A}$; $I_B = 1\text{ mA}$)	V_{BEsat}	<2.2	<2.2	<2.2	V

Dynamic characteristics ($T_{amb} = 25^{\circ}\text{C}$)

Transition frequency ($I_C = 0.5\text{ A}$; $V_{CE} = 5\text{ V}$; $f = 35\text{ MHz}$) f_T	200	200	200	MHz
--	-----	-----	-----	-----

PNP Silicon Planar Darlington Transistors

BD 876
BD 878
BD 880

BD 876, BD 878, and BD 880 are epitaxial PNP silicon planar darlington transistors in TO 126 plastic package (12 A 3 DIN 41 869, sheet 4). These darlington transistors are designed for relay drivers as well as for general AF applications. BD 875, BD 877, and BD 879 are provided as complementary transistors.

Type	Ordering code
BD 876	Q62702-D908
BD 878	Q62702-D907
BD 880	Q62702-D906
Spring washer A 3 DIN 137	Q62902-B63
Mica washer	Q62902-B62

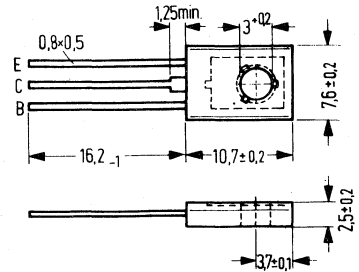
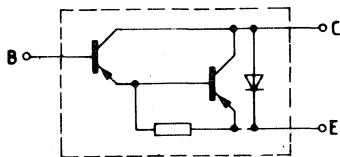

Approx. weight 0.5 g. Dimensions in mm
 Transistor fixing with M 3 screw, starting torque
 max. 0.8 Nm; washer or spring washer should
 be used.

Maximum ratings ($T_{amb} = 25^{\circ}\text{C}$)

Collector-emitter voltage	$-V_{CEO}$	45	60	80	V
Collector-base voltage	$-V_{CBO}$	60	80	100	V
Emitter-base voltage	$-V_{EBO}$	5	5	5	V
Collector current	$-I_C$	1	1	1	A
Collector peak current	$-I_{CM}$	2	2	2	A
Base current	$-I_B$	0.1	0.1	0.1	A
Junction temperature	T_j	150	150	150	$^{\circ}\text{C}$
Storage temperature range	T_{stg}	-65 to +150			$^{\circ}\text{C}$
Total power dissipation	P_{tot}	1.25	1.25	1.25	W
($T_{amb} \leq 25^{\circ}\text{C}$)		9	9	9	W
($T_{case} \leq 60^{\circ}\text{C}$)					

Thermal resistance

Junction to ambient air	R_{thJA}	<100	<100	<100	K/W
Junction to case	R_{thJC}	<10	<10	<10	K/W

Static characteristics ($T_{amb} = 25^{\circ}\text{C}$)		BD 876	BD 878	BD 880	
Collector cutoff current ($V_{CB} = V_{CBmax}$)	$-I_{CBO}$	< 100	< 100	< 100	nA
Collector cutoff current ($V_{CE} = 0.5 V_{CEmax}$)	$-I_{CEO}$	< 500	< 500	< 500	nA
Emitter cutoff current ($-V_{EB} = 4 \text{ V}$)	$-I_{EBO}$	< 100	< 100	< 100	nA
Collector-emitter breakdown voltage ($-I_C = 50 \text{ mA}$)	$-V_{(BR)CEO}$	> 45	> 60	> 80	V
Collector-base breakdown voltage ($-I_C = 100 \mu\text{A}$)	$-V_{(BR)CBO}$	> 60	> 80	> 100	V
Emitter-base breakdown voltage ($I_E = 100 \mu\text{A}$)	$-V_{(BR)EBO}$	> 5	> 5	> 5	V
DC current gain ($-I_C = 150 \text{ mA}; -V_{CE} = 10 \text{ V}$)	h_{FE}	> 1000	> 1000	> 1000	-
($-I_C = 0.5 \text{ A}; -V_{CE} = 10 \text{ V}$)	h_{FE}	> 2000	> 2000	> 2000	-
Collector-emitter saturation voltage ($-I_C = 0.5 \text{ A}; -I_B = 0.5 \text{ mA}$)	$-V_{CEsat}$	< 1.3	< 1.3	< 1.3	V
($-I_C = 1 \text{ A}; -I_B = 1 \text{ mA}$)	$-V_{CEsat}$	< 1.8	< 1.8	< 1.8	V
Base-emitter saturation voltage ($-I_C = 1 \text{ A}; -I_B = 1 \text{ mA}$)	$-V_{BEsat}$	< 2.2	< 2.2	< 2.2	V

Dynamic characteristics ($T_{amb} = 25^{\circ}\text{C}$)

Transition frequency ($-I_C = 0.5 \text{ A}; -V_{CE} = 5 \text{ V}; f = 35 \text{ MHz}$)	f_T	200	200	200	MHz
---	-------	-----	-----	-----	-----

NPN Silicon Darlington Transistors

BD 975
BD 977
BD 979

BD 975, BD 977, and BD 979 are epitaxial NPN silicon planar darlington transistors in plastic package similar to TO 202. These darlington transistors are designed for relay drivers as well as for general AF applications.

BD 976, BD 978, and BD 980 are provided as complementary transistors.

Type	Ordering code
BD 975	Q62702-D962
BD 977	Q62702-D964
BD 979	Q62702-D966

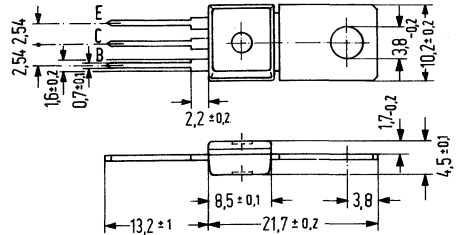
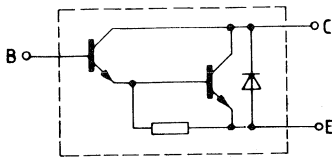

Approx. weight 15 g. Dimensions in mm

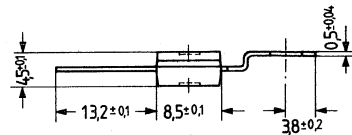

Available upon request also with bent fixing plate.

Maximum ratings

Collector-emitter voltage	V_{CEO}	45	60	80	V
Collector-base voltage	V_{CBO}	60	80	100	V
Emitter-base voltage	V_{EBO}	5	5	5	V
Collector current	I_C	1	1	1	A
Collector peak current	I_{CM}	2	2	2	A
Base current	I_B	0.1	0.1	0.1	A
Storage temperature range	T_{stg}	-65 to +150			°C
Junction temperature	T_j	150	150	150	°C
Total power dissipation	P_{tot}	1.6	1.6	1.6	W
($T_{amb} = 25^\circ\text{C}$)		3.6	3.6	3.6	W
($T_{case} = 60^\circ\text{C}$)					

Thermal resistance

Junction to ambient air	R_{thJA}	78	78	78	K/W
Junction to case	R_{thJC}	25	25	25	K/W

Static characteristics ($T_{amb} = 25^{\circ}\text{C}$)		BD 975	BD 977	BD 979	
Collector cutoff current ($V_{CBO} = V_{CBmax}$)	I_{CBO}	<100	<100	<100	nA
Collector cutoff current ($V_{CEO} = 0.5 V_{CEmax}$)	I_{CEO}	<500	<500	<500	nA
Emitter cutoff current ($V_{EBO} = 4\text{ V}$)	I_{EBO}	<100	<100	<100	nA
Collector-emitter breakdown voltage ($I_C = 50\text{ mA}$)	$V_{(BR)CEO}$	>45	>60	>80	V
Collector-base breakdown voltage ($I_C = 100\text{ }\mu\text{A}$)	$V_{(BR)CBO}$	>60	>80	>100	V
Emitter-base breakdown voltage ($I_E = 100\text{ }\mu\text{A}$)	$V_{(BR)EBO}$	>5	>5	>5	V
DC current gain ($I_C = 150\text{ mA}$; $V_{CE} = 10\text{ V}$)	h_{FE}	>1000	>1000	>1000	-
($I_C = 0.5\text{ A}$; $V_{CE} = 10\text{ V}$)	h_{FE}	>2000	>2000	>2000	-
Collector-emitter saturation voltage ($I_C = 0.5\text{ A}$; $I_B = 0.5\text{ mA}$)	V_{CEsat}	<1.3	<1.3	<1.3	V
($I_C = 1\text{ A}$; $I_B = 1\text{ mA}$)	V_{CEsat}	<1.8	<1.8	<1.8	V
Base-emitter saturation voltage ($I_C = 1\text{ A}$; $I_B = 1\text{ mA}$)	V_{BEsat}	<2.2	<2.2	<2.2	V

Dynamic characteristics ($T_{amb} = 25^{\circ}\text{C}$)

Transition frequency ($I_C = 0.5\text{ A}$; $V_{CE} = 5\text{ V}$; $f = 35\text{ MHz}$)	f_T	200	200	200	MHz
--	-------	-----	-----	-----	-----

Total perm. power dissipation versus temperature

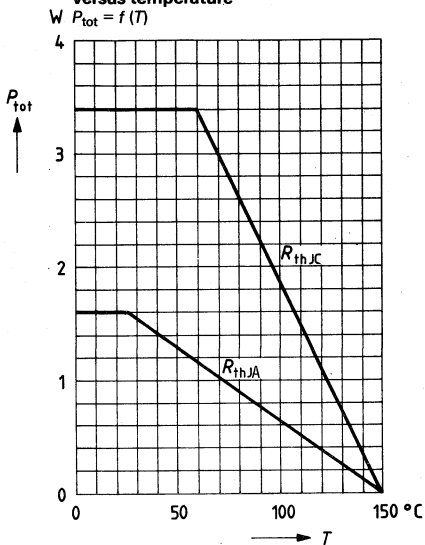

Permissible operating range

$I_C = f(V_{CE}); T_{case} \leq 100^\circ C; D = 0$

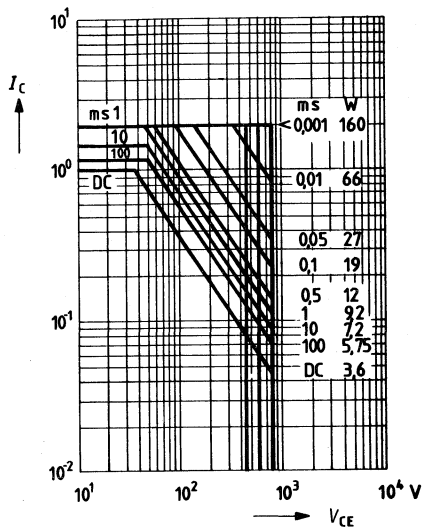

Permissible power dissipation

$\frac{Z_{th}}{R_{th}} = f(\tau)$

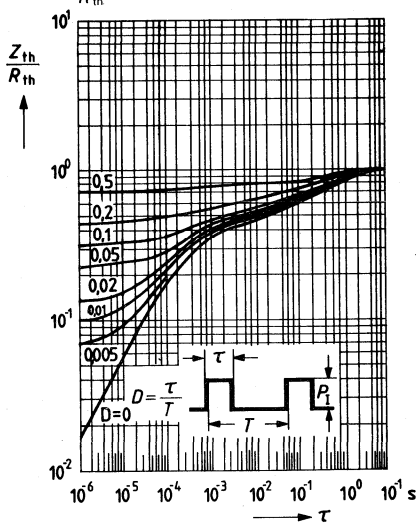

DC current gain $h_{FE} = f(T_{amb})$

$V_{CE} = 10 V; I_C = \text{parameter}$

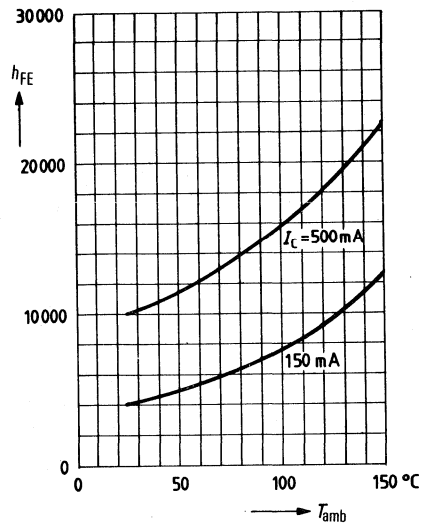

Collector-emitter saturation voltage

$V_{CEsat} = f(I_C)$

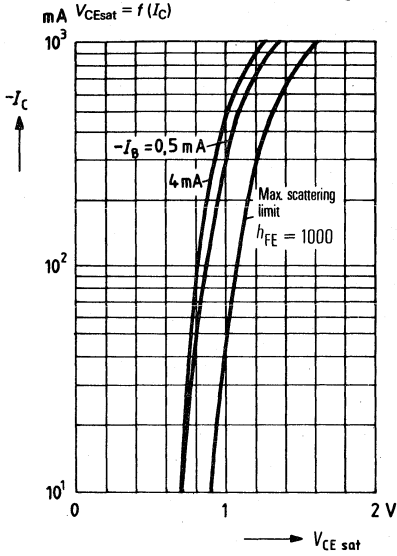

Base-emitter saturation voltage

$V_{BEsat} = f(I_C)$

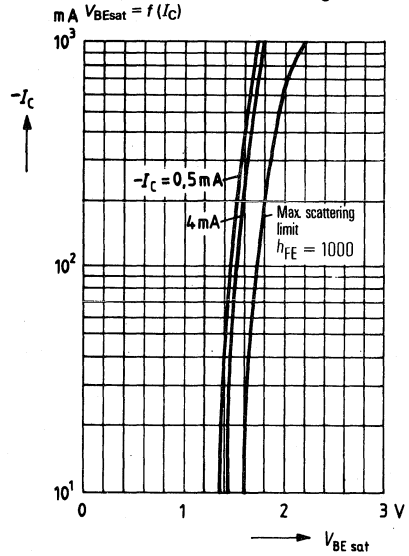

Collector current $I_C = f(V_{BE})$

$V_{CE} = 10 \text{ V}$

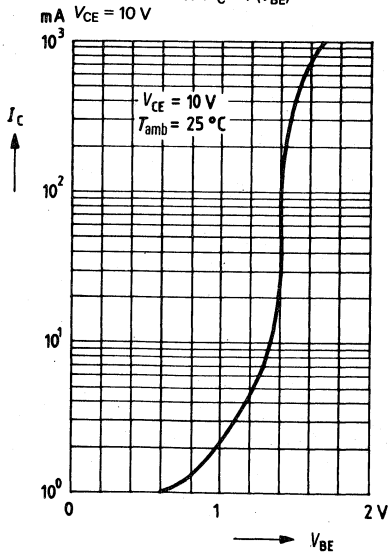

DC current gain $h_{FE} = f(I_C)$

$V_{CE} = 10 \text{ V}$

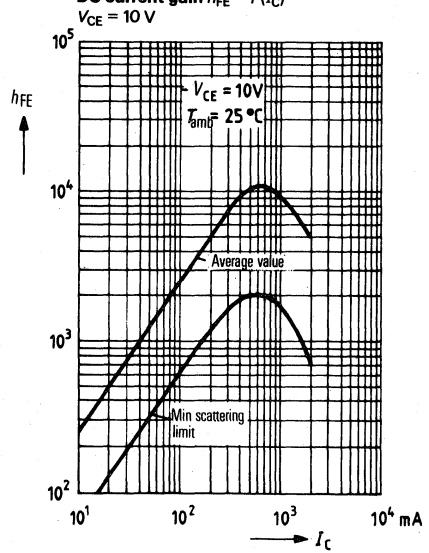

PNP Silicon Darlington Transistors

BD 976
BD 978
BD 980

BD 976, BD 978, and BD 980 are epitaxial PNP silicon planar darlington transistors in plastic package similar to TO 202. These darlington transistors are designed for relay drivers as well as for general AF applications.

BD 975, BD 977, and BD 979 are provided as complementary transistors.

Type	Ordering code
BD 976	Q62702-D963
BD 978	Q62702-D965
BD 980	Q62702-D967

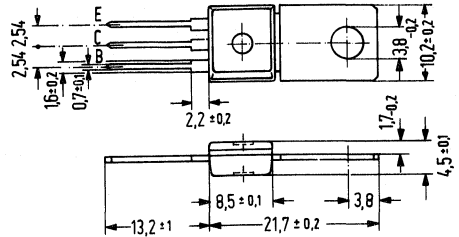
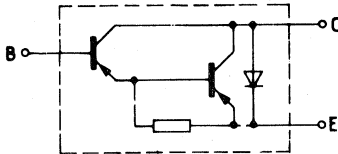

Approx. weight 15 g. Dimensions in mm

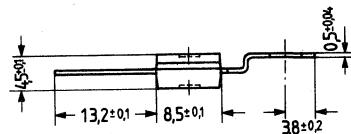

Available upon request also with bent fixing plate.

Maximum ratings ($T_{amb} = 25^{\circ}\text{C}$)

Collector-emitter voltage	$-V_{CEO}$	45	60	80	V
Collector-base voltage	$-V_{CBO}$	60	80	100	V
Emitter-base voltage	$-V_{EBO}$	5	5	5	V
Collector current	$-I_C$	1	1	1	A
Collector peak current	$-I_{CM}$	2	2	2	A
Base current	$-I_B$	0.1	0.1	0.1	A
Junction temperature	T_j	150	150	150	$^{\circ}\text{C}$
Storage temperature range	T_{stg}	-65 to +150			$^{\circ}\text{C}$
Total power dissipation	P_{tot}	1.6	1.6	1.6	W
($T_{amb} = 25^{\circ}\text{C}$)	P_{tot}	3.6	3.6	3.6	W
($T_{case} = 60^{\circ}\text{C}$)					

Thermal resistance

Junction to ambient air	R_{thJA}	78	78	78	K/W
Junction to case	R_{thJC}	25	25	25	K/W

	BD 976	BD 978	BD 980	
$-V_{CEO}$	45	60	80	V
$-V_{CBO}$	60	80	100	V
$-V_{EBO}$	5	5	5	V
$-I_C$	1	1	1	A
$-I_{CM}$	2	2	2	A
$-I_B$	0.1	0.1	0.1	A
T_j	150	150	150	$^{\circ}\text{C}$
T_{stg}	-65 to +150			$^{\circ}\text{C}$
P_{tot}	1.6	1.6	1.6	W
P_{tot}	3.6	3.6	3.6	W

R_{thJA}	78	78	78	K/W
R_{thJC}	25	25	25	K/W

Static characteristics ($T_{amb} = 25^{\circ}\text{C}$)

		BD 976	BD 978	BD 980	
Collector cutoff current ($-V_{CBO} = V_{CBmax}$)	$-I_{CBO}$	100	100	100	nA
Collector cutoff current ($-V_{CEO} = 0.5 V_{CEmax}$)	$-I_{CEO}$	500	500	500	nA
Emitter cutoff current ($-V_{EBO} = 4\text{ V}$)	$-I_{EBO}$	100	100	100	nA
Collector-emitter breakdown voltage ($-I_C = 50\text{ mA}$)	$-V_{(BR)CEO}$	>45	>60	>80	V
Collector-base breakdown voltage ($-I_C = 100\text{ }\mu\text{A}$)	$-V_{(BR)CBO}$	>60	>80	>100	V
Emitter-base breakdown voltage ($I_E = 100\text{ }\mu\text{A}$)	$-V_{(BR)EBO}$	>5	>5	>5	V
DC current gain ($-I_C = 150\text{ mA}$; $-V_{CE} = 10\text{ V}$)	h_{FE}	>1000	>1000	>1000	-
($-I_C = 0.5\text{ A}$; $-V_{CE} = 10\text{ V}$)	h_{FE}	>2000	>2000	>2000	-
Collector-emitter saturation voltage ($-I_C = 0.5\text{ A}$; $-I_B = 0.5\text{ mA}$)	$-V_{CEsat}$	<1.3	<1.3	<1.3	V
($-I_C = 1\text{ A}$; $-I_B = 1\text{ mA}$)	$-V_{CEsat}$	<1.8	<1.8	<1.8	V
Base-emitter saturation voltage ($-I_C = 1\text{ A}$; $-I_B = 1\text{ mA}$)	$-V_{BEsat}$	<2.2	<2.2	<2.2	V

Dynamic characteristics ($T_{amb} = 25^{\circ}\text{C}$)

Transition frequency ($-I_C = 0.5\text{ A}$; $-V_{CE} = 5\text{ V}$; $f = 35\text{ MHz}$)	f_T	200	200	200	MHz
--	-------	-----	-----	-----	-----

Total perm. power dissipation versus temperature

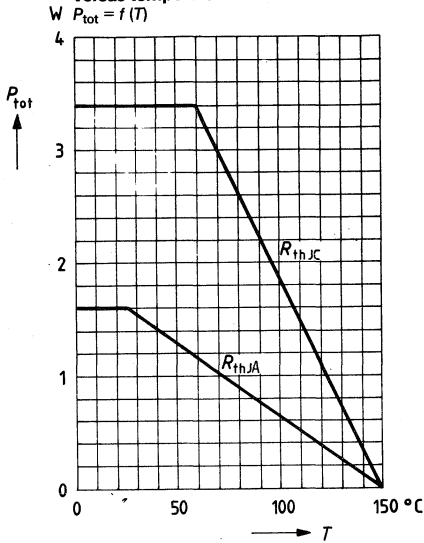

Permissible operating range
 $I_C = f(V_{CE}); T_{case} \leq 100^\circ\text{C}; D = 0$

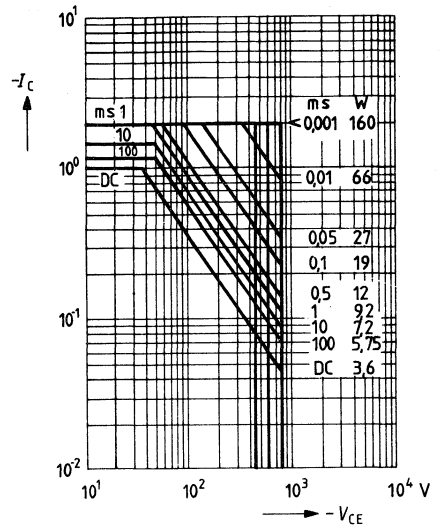

Total perm. power dissipation

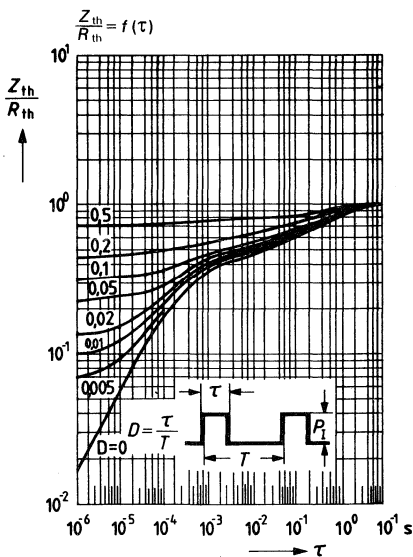

DC current gain $h_{FE} = f(T_{amb})$
 $V_{CE} = 10\text{ V}; I_C = \text{parameter}$

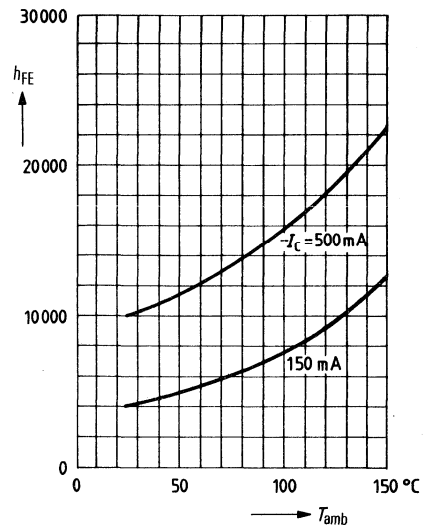

Collector-emitter saturation voltage

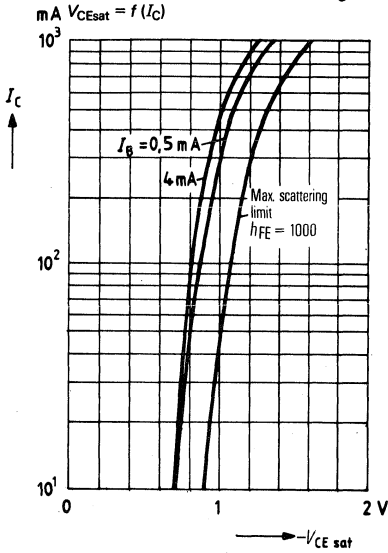

Base-emitter saturation voltage

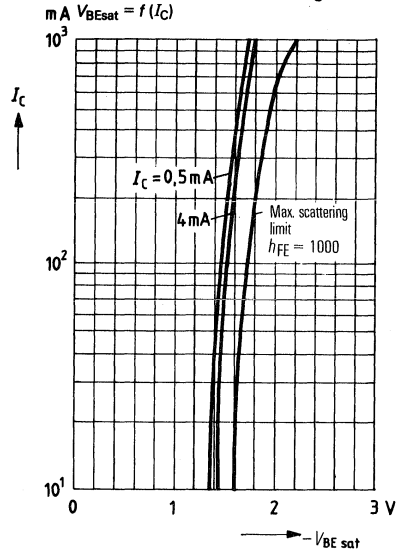

Collector current $I_C = f(V_{BE})$

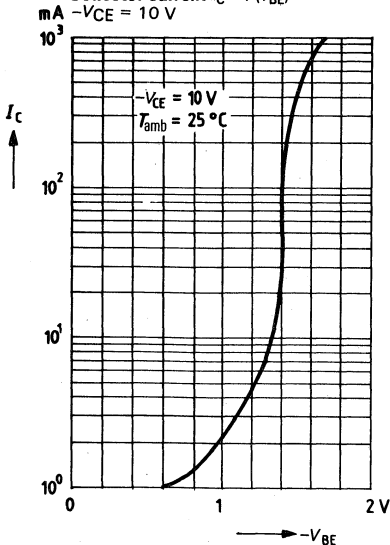

DC current gain $h_{FE} = f(I_C)$

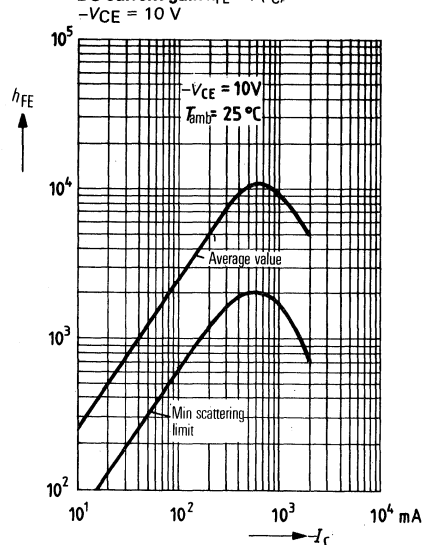

BDW 25, BDY 12, and BDY 13 are epitaxial NPN silicon planar power transistors in SOT 9 case (9 A 2 DIN 41875). The collector is electrically connected to the case. In order to ensure insulated fixing of the transistors on the chassis, a mica washer, each, and two insulating nipples are provided for. These have to be ordered separately. The transistors are particularly suitable for use in high Q AF output stages and as switches.

Type	Ordering code
BDW 25	Q62702-D378
BDW 25-4	Q62702-D378-V4
BDW 25-6	Q62702-D378-V2
BDW 25-10	Q62702-D378-V1
BDY 12	Q60204-Y12
BDY 12-6	Q60204-Y12-B
BDY 12-10	Q60204-Y12-C
BDY 12-16	Q60204-Y12-D
BDY 13	Q60204-Y13
BDY 13-6	Q60204-Y13-B
BDY 13-10	Q60204-Y13-C
BDY 13-16	Q60204-Y13-D
Mica washer	Q62901-B16-A
Insulating nipple	Q62901-B13-C

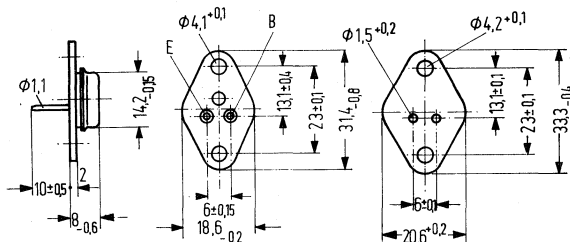

Approx. weight 8.3 g Dimensions in mm
Mica washer
dry: $R_{th} = 2.5 \text{ K/W}$
greased: $R_{th} = 1 \text{ K/W}$

Maximum ratings

	BDW 25	BDY 12	BDY 13		
Collector emitter voltage	V_{CEO}	125	40	60	V
Collector-base voltage	V_{CBO}	130	60	80	V
Emitter-base voltage	V_{EBO}	5	5	5	V
Collector current	I_C	5	5	5	A
Emitter current	I_E	3.5	—	—	A
Emitter peak current ¹⁾	I_{EM}	6	—	—	A
Base current	I_B	0.5	0.3	0.3	A
Base peak current ¹⁾	I_{BM}	1	—	—	A
Junction temperature	T_j	175	175	175	°C
Storage temperature range	T_{stg}	-65 to +125			°C
Total power dissipation ($T_{case} = 45 \text{ °C}; V_{CE} < 13 \text{ V}$)	P_{tot}	26	26	26	W

Thermal resistance

Junction to ambient air	R_{thJA}	≤ 85	≤ 85	≤ 85	K/W
Junction to case	R_{thJC}	≤ 5	≤ 5	≤ 5	K/W

1) $v \geq 10 \text{ tp}; t_p \leq 10 \text{ ns}$

Static characteristics ($T_{\text{case}} = 25^\circ\text{C}$)

The transistors BDW 25, BDY 12, and BDY 13 are grouped according to the DC current gain h_{FE} at $I_C = 1\text{ A}$, $V_{CE} = 1\text{ V}$, and marked by numerals of the German DIN-R-5 standard. For the conditions stated below, the following data applies:

Type		BDW 25	BDW 25 BDY 12, BDY 13		BDY 12, BDY 13	BDW 25 BDY 12 BDY 13
h_{FE} group		4	6	10	16	
V_{CE} V	I_C A	h_{FE} I_C/I_B	h_{FE} I_C/I_B	h_{FE} I_C/I_B	h_{FE} I_C/I_B	V_{BE} V
1	0.01	35 (> 15)	55	75	120	
1	1	40 (25 to 60)	63 (40 to 100)	100 (63 to 160)	160 (100 to 250)	<1.2*
2	3	25 (> 10)	40	70	120	<1.4

Static characteristics ($T_{\text{case}} = 25^\circ\text{C}$)

	BDW 25	BDY 12	BDY 13		
Collector-emitter saturation voltage ($I_C = 3\text{ A}$; $I_B = 0.3\text{ A}$)	V_{CEsat}	<1	<1	<1	V
Base-emitter saturation voltage ($I_C = 3\text{ A}$; $I_B = 0.3\text{ A}$)	V_{BEsat}	1 (<1.4)	1 (<1.3)	1 (<1.3)	V
Collector cutoff current ($V_{CE} = 80\text{ V}$)	I_{CES}	<1	-	-	μA
Collector cutoff current ($V_{CE} = 80\text{ V}$; $T_{\text{amb}} = 125^\circ\text{C}$)	I_{CES}	<400	-	-	μA
Collector cutoff current ($V_{CES} = 40\text{ V}$)	I_{CES}	-	<1	-	μA
Collector cutoff current ($V_{CES} = 40\text{ V}$; $T_{\text{amb}} = 125^\circ\text{C}$)	I_{CES}	-	<400	-	μA
Collector cutoff current ($V_{CES} = 60\text{ V}$)	I_{CES}	-	-	<1	μA
Collector cutoff current ($V_{CES} = 60\text{ V}$; $T_{\text{amb}} = 125^\circ\text{C}$)	I_{CES}	-	-	<400	μA
Emitter cutoff current ($V_{EBO} = 4\text{ V}$)	I_{EBO}	<1	<1	<1	μA

* AQL = 0.65%

Static characteristics ($T_{case} = 25^{\circ}C$)		BDW 25	BDY 12	BDY 13	
Collector emitter breakdown voltage ($I_C = 50\text{ mA}$) (Pulse width 200 μs , duty cycle 1%)	$V_{(BR)CEO}$	> 125	> 40	> 60	V
Collector base breakdown voltage ($I_C = 100\ \mu\text{A}$)	$V_{(BR)CBO}$	> 130	> 60	> 80	V
Emitter base breakdown voltage ($I_C = 10\ \mu\text{A}$)	$V_{(BR)EBO}$	> 5	> 5	> 5	V
Dynamic characteristics ($T_{amb} = 25^{\circ}C$)					
Transition frequency ($I_C = 200\text{ mA}$; $V_{CE} = 10\text{ V}$; $f = 20\text{ MHz}$)	f_T	> 30	70 (> 30)	70 (> 30)	MHz
Collector base capacitance ($V_{CB} = 10\text{ V}$; $I_E = 0$; $f = 1\text{ MHz}$)	C_{CBO}	< 70	35 (< 70)	35 (< 70)	pF
Switching times					
($I_C = 1\text{ A}$; I_{B1} approx. $-I_{B2}$ approx. 50mA)	t_{on}	< 0,3	< 0,3	< 0,3	μs
	t_{off}	< 1,5	< 1,5	< 1,5	μs
($I_C = 2\text{ A}$; I_{B1} approx. $-I_{B2}$ approx. 200mA)	t_{on}	< 0,5	-	-	μs
	t_{off}	< 2	-	-	μs
	t_s	< 1	-	-	μs

Test circuit for switching times

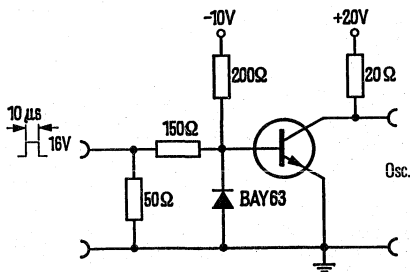

Total perm. power dissipation versus temperature

$P_{tot} = f(T_{case}); V_{CE} = \text{parameter}$

BDY 12

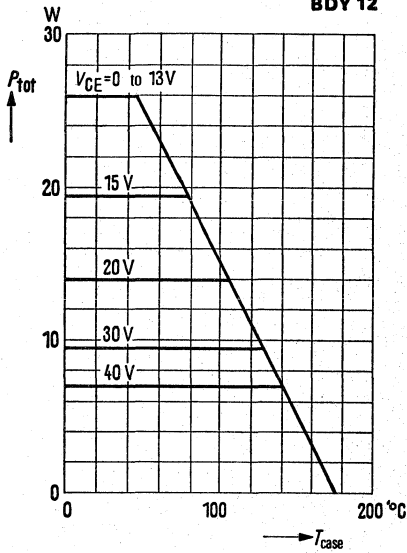

Total perm. power dissipation versus temperature

$P_{tot} = f(T_{case}); V_{CE} = \text{parameter}$

BDY 13

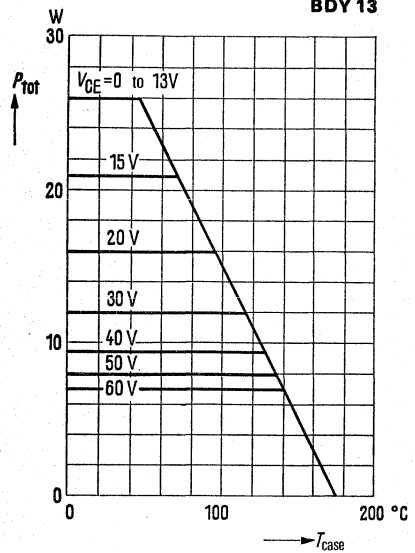

Total perm. power dissipation versus temperature

$P_{tot} = f(T_{case}); V_{CE} = \text{parameter}$

BDW 25

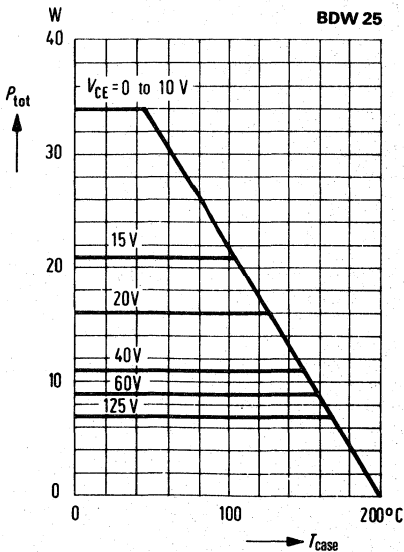

Permissible pulse load

$r_{thJC} = f(t); v = \text{parameter}$

BDW 25

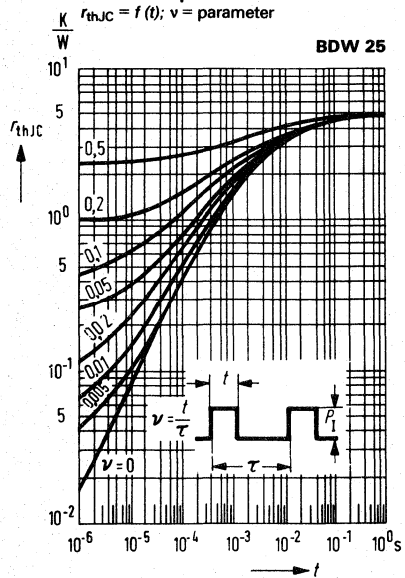

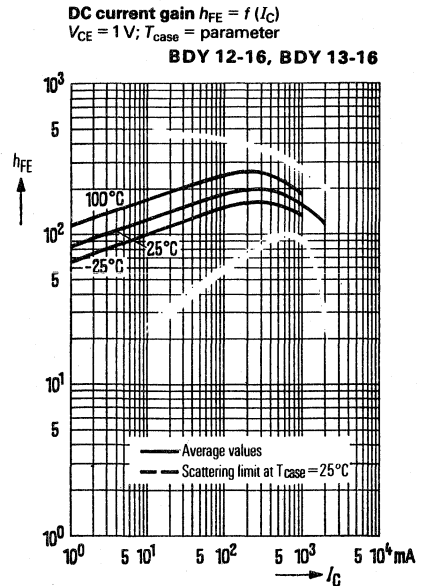
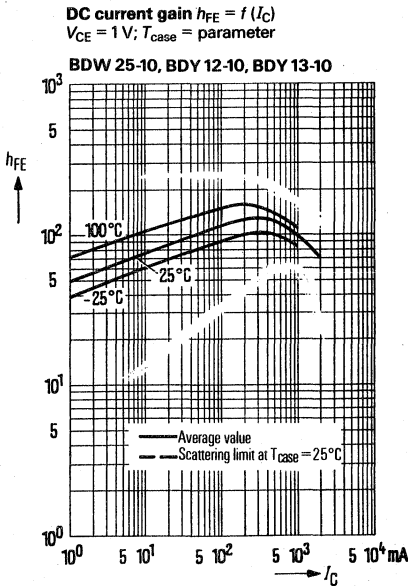
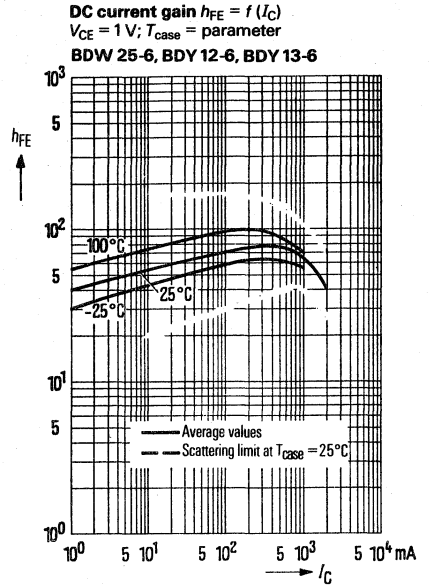
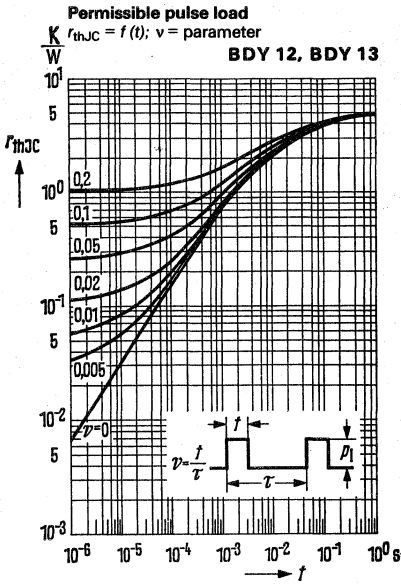

Output characteristics $I_C = f(V_{CE})$
 $I_B = \text{parameter}$
 (common emitter configuration)

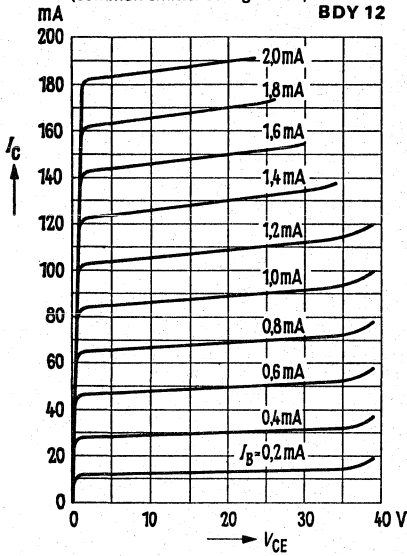

Output characteristics $I_C = f(V_{CE})$
 $I_B = \text{parameter}$
 (common emitter configuration)

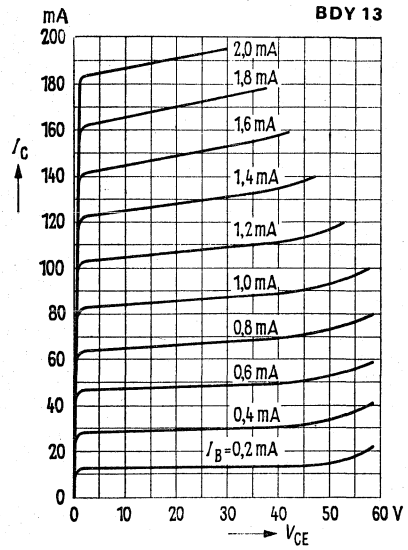

Output characteristics $I_C = f(V_{CE})$
 $I_B = \text{parameter}$
 (common emitter configuration)

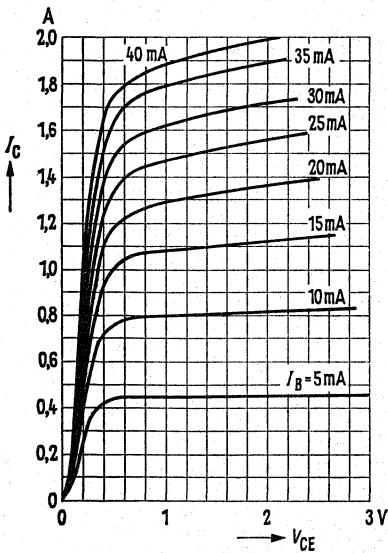

Collector current $I_C = f(V_{BE})$
 $V_{CE} = 1 \text{ V}$

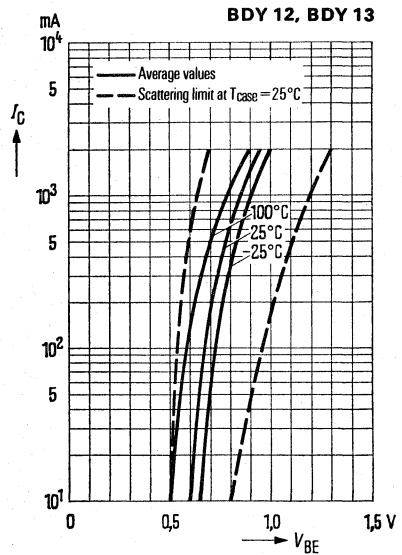

Collector-emitter saturation voltage

$V_{CEsat} = f(I_C)$

$h_{FE} = 10; T_{case} = \text{parameter}$

(common emitter configuration)

BDY 12, BDY 13

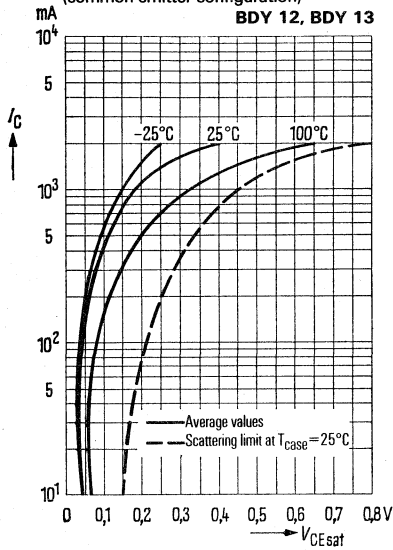

Base-emitter saturation voltage

$V_{BEsat} = f(I_C)$

$h_{FE} = 10; T_{case} = \text{parameter}$

(common emitter configuration)

BDY 12, BDY 13

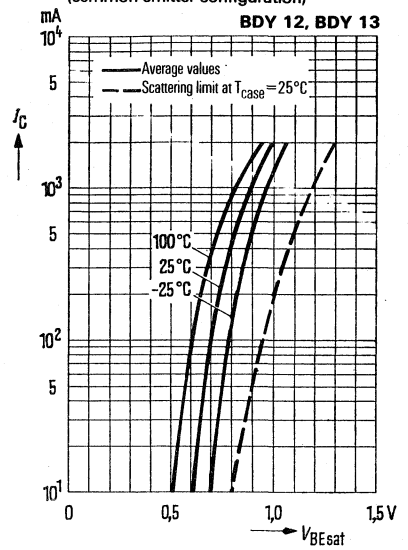

Collector cutoff current versus temperature

$I_{CBO} = f(T_{case})$ for maximum permissible reverse voltage

BDY 12, BDY 13

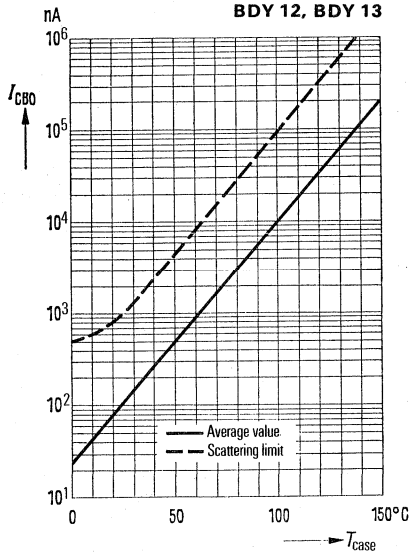

BDX 27, BDX 28, BDX 29, and BDX 30 are epitaxial PNP silicon power transistors in SOT 9 case (9 A 2 DIN 41875). The collector is electrically connected to the case. The transistors are particularly suitable for use in high Q AF output stages and for switching applications.

Type	Ordering code	Type	Ordering code
BDX 27	Q62702-D162	BDX 29	Q62702-D160
BDX 27-6	Q62702-D162-V6	BDX 29-6	Q62702-D160-V6
BDX 27-10	Q62702-D162-V10	BDX 29-10	Q62702-D160-V10
BDX 27-16	Q62702-D162-V16	BDX 30	Q62702-D163
BDX 28	Q62702-D159	BDX 30-6	Q62702-D163-V6
BDX 28-6	Q62702-D159-V6	BDX 30-10	Q62702-D163-V10
BDX 28-10	Q62702-D159-V10	Mica washer	Q62902-B16-A
BDX 28-16	Q62702-D159-V16	Insulating nipple	Q62902-B50

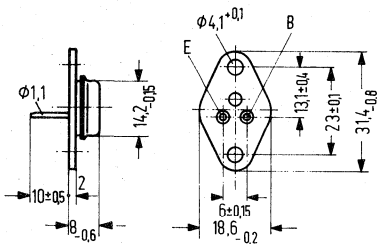

Approx. weight 8.3 g. Dimensions in mm

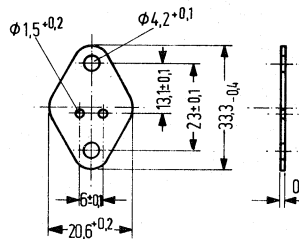

Mica washer
 dry: $R_{th} = 2.5 \text{ K/W}$
 greased: $R_{th} = 1 \text{ K/W}$

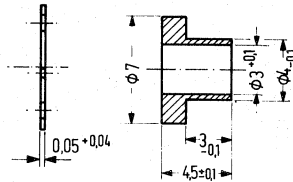

Insulating nipple scale 2:1

Maximum ratings

	BDX 27	BDX 28	BDX 29	BDX 30		
Collector-emitter voltage	$-V_{CEO}$	40	60	80	125	V
Collector-emitter voltage	$-V_{CES}$	40	60	80	125	V
Collector-base voltage	$-V_{CBO}$	40	60	80	125	V
Emitter-base voltage	$-V_{EBO}$	5	5	5	5	V
Collector peak current ($t \leq 1 \text{ ms}$)	$-I_{CM}$	7	7	7	7	A
Collector current	$-I_C$	5	5	5	5	A
Emitter current	$-I_E$	6	6	6	6	A
Base current	$-I_B$	1	1	1	1	A
Junction temperature	T_j	200	200	200	200	°C
Storage temperature range	T_{stg}	-65 to +200				°C
Total power dissipation ($T_{case} < 45^\circ\text{C}; V_{CE} < 13 \text{ V}$)	P_{tot}	50	50	50	50	W

Thermal resistance

Junction to ambient air	R_{thJA}	≤ 85	≤ 85	≤ 85	≤ 85	K/W
Junction to case	R_{thJC}	≤ 3.5	≤ 3.5	≤ 3.5	≤ 3.5	K/W

Static characteristics ($T_{\text{case}} = 25^{\circ}\text{C}$)

		BDX 27	BDX 28	BDX 29	BDX 30	
Collector-emitter breakdown voltage ($I_C = -50 \text{ mA}$)	$-V_{(\text{BR})\text{CEO}}$	> 40	> 60	> 80	> 125	V
Collector-emitter breakdown voltage ($I_C = 0.1 \text{ mA}$)	$-V_{(\text{BR})\text{CES}}$	> 40	> 60	> 80	> 125	V
Emitter-base breakdown voltage ($I_E = -10 \mu\text{A}$)	$-V_{(\text{BR})\text{EBO}}$	> 5	> 5	> 5	> 5	V
Collector cutoff current ($-V_{\text{CE}} = 40 \text{ V}$)	$-I_{\text{CBO}}$	< 1	-	-	-	μA
($-V_{\text{CE}} = 40 \text{ V}; T_{\text{case}} = 150^{\circ}\text{C}$)	$-I_{\text{CBO}}$	< 100	-	-	-	μA
($-V_{\text{CE}} = 60 \text{ V}$)	$-I_{\text{CBO}}$	-	< 1	-	-	μA
($-V_{\text{CE}} = 60 \text{ V}; T_{\text{case}} = 150^{\circ}\text{C}$)	$-I_{\text{CBO}}$	-	< 100	-	-	μA
($-V_{\text{CE}} = 80 \text{ V}$)	$-I_{\text{CBO}}$	-	-	< 1	-	μA
($-V_{\text{CE}} = 80 \text{ V}; T_{\text{case}} = 150^{\circ}\text{C}$)	$-I_{\text{CBO}}$	-	-	< 100	-	μA
($-V_{\text{CE}} = 125 \text{ V}$)	$-I_{\text{CBO}}$	-	-	-	< 1	μA
($-V_{\text{CE}} = 125 \text{ V}; T_{\text{case}} = 150^{\circ}\text{C}$)	$-I_{\text{CBO}}$	-	-	-	< 100	μA
Collector cutoff current ($-V_{\text{CE}} = 40 \text{ V}; -V_{\text{BE}} = 0.2 \text{ V};$ $T_{\text{case}} = 100^{\circ}\text{C}$)	$-I_{\text{CEX}}$	< 300	-	-	-	μA
($-V_{\text{CE}} = 60 \text{ V}; -V_{\text{BE}} = 0.2 \text{ V};$ $T_{\text{case}} = 100^{\circ}\text{C}$)	$-I_{\text{CEX}}$	-	< 300	-	-	μA
($-V_{\text{CE}} = 80 \text{ V}; -V_{\text{BE}} = 0.2 \text{ V};$ $T_{\text{case}} = 100^{\circ}\text{C}$)	$-I_{\text{CEX}}$	-	-	< 300	-	μA
($-V_{\text{CE}} = 100 \text{ V}; -V_{\text{BE}} = 0.2 \text{ V};$ $T_{\text{case}} = 100^{\circ}\text{C}$)	$-I_{\text{CEX}}$	-	-	-	< 300	μA

BDX 27
BDX 28
BDX 29
BDX 30

Static characteristics		BDX 27	BDX 28	BDX 29	BDX 30	
Emitter cutoff current ($-V_{EB} = 4 \text{ V}$)	$-I_{EBO}$	<1	<1	<1	<1	μA
Base-emitter forward voltage ($-I_C = 1 \text{ A}; -V_{CE} = 1 \text{ V}$) ($-I_C = 5 \text{ A}; -V_{CE} = 2 \text{ V}$)	$-V_{BE}$	<1.1	<1.1	<1.1	<1.1	V
	$-V_{BE}$	<1.7	<1.7	<1.7	<1.7	V
Collector-emitter saturation voltage ($-I_C = 1 \text{ A}; -I_B = 0.1 \text{ A}$) ($-I_C = 3 \text{ A}; -I_B = 0.3 \text{ A}$)	$-V_{CEsat}$	<0.5	<0.5	<0.5	<0.5	V
	$-V_{CEsat}$	<1.0	<1.0	<1.0	<1.0	V

The transistors are grouped according to the DC current gain h_{FE} and marked by numerals of the German DIN R 5 standard.

Type		BDX 27 BDX 28 BDX 29	BDX 27 BDX 28 BDX 29	BDX 27 BDX 28 BDX 29
h_{FE} group		6	10	16
$-I_C$ mA	$-V_{CE}$ V	h_{FE} I_C/I_B	h_{FE} I_C/I_B	h_{FE} I_C/I_B
10	1	40 (>30)	115 (>55)	180 (>80)
1000	1	63 (40-100)	100 (63-160)	160 (100-250)
3000	2	32 (>20)	55 (>20)	85 (>20)
5000	2	20 (>10)	55 (>20)	85 (>20)

Type		BDX 30	BDX 30
h_{FE} group		6	10
10	1	70 (>30)	115 (>30)
1000	1	63 (>40-100)	100 (63-160)
3000	2	32 (>15)	55 (>15)
5000	2	20 (>7)	55 (>7)

		BDX 27	BDX 28	BDX 29	BDX 30	
Transition frequency ($-I_C = 200 \text{ mA}; -V_{CE} = 10 \text{ V};$ $f = 20 \text{ MHz}$)	f_T	50	50	50	50	MHz
Output capacitance ($-V_{CB} = 10 \text{ V}$)	C_{ob}	130	130	100	100	pF
Switching times:						
Operating point: ($-I_C = 2 \text{ A}; -I_{B1} \text{ approx. } I_{B2} = 200 \text{ mA}$)	t_{on}	<0.5	<0.5	<0.5	<0.5	μs
($-I_C = 2 \text{ A}; -I_{B1} \text{ approx. } I_{B2} = 200 \text{ mA}$)	t_{off}	<2	<2	<2	<2	μs

Total perm. power dissipation versus temperature

$P_{tot} = f(T_{case}); V_{CE} = \text{parameter}$

BDX 27

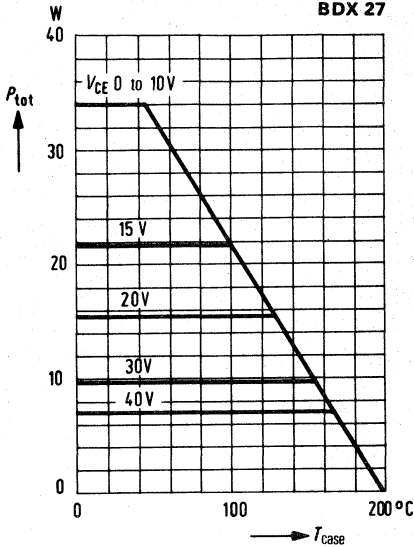

Total perm. power dissipation versus temperature

$P_{tot} = f(T_{case}); V_{CE} = \text{parameter}$

BDX 28

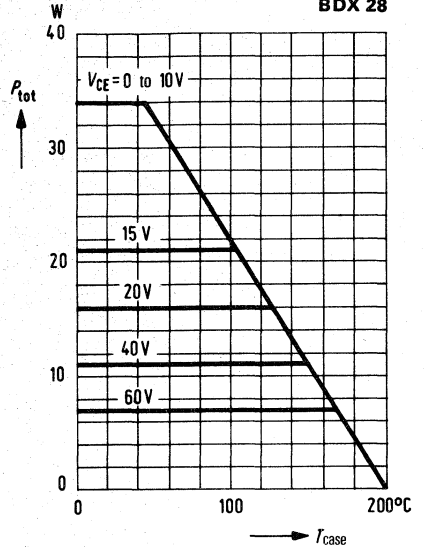

Total perm. power dissipation versus temperature

$P_{tot} = f(T_{case}); V_{CE} = \text{parameter}$

BDX 29

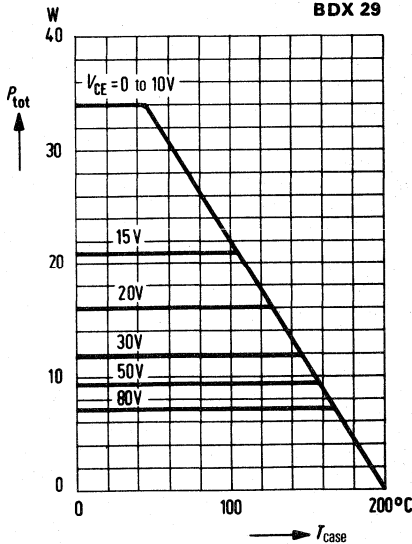

Total perm. power dissipation versus temperature

$P_{tot} = f(T_{case}); V_{CE} = \text{parameter}$

BDX 30

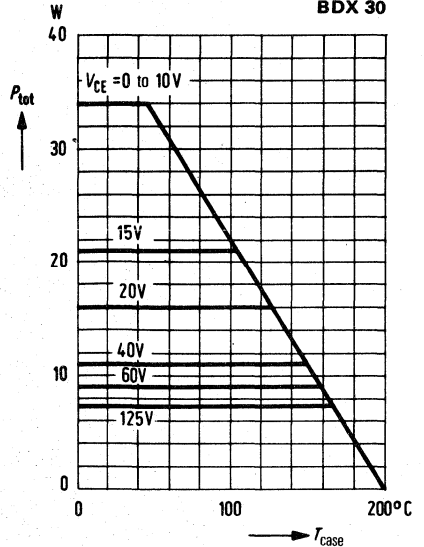

BDX 27
BDX 28
BDX 29
BDX 30

Permissible operating range
 $I_C = f(V_{CE}); T_{case} = 45^\circ C$

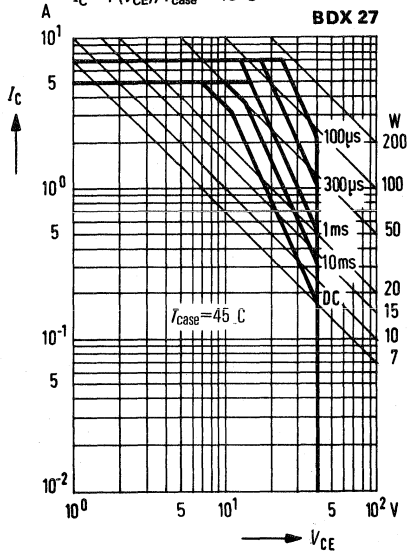

Permissible operating range
 $I_C = f(V_{CE}); T_{case} = 45^\circ C$

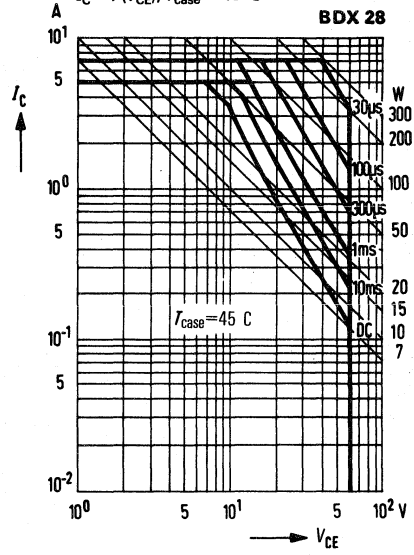

Permissible operating range
 $I_C = f(V_{CE}); T_{case} = 45^\circ C$

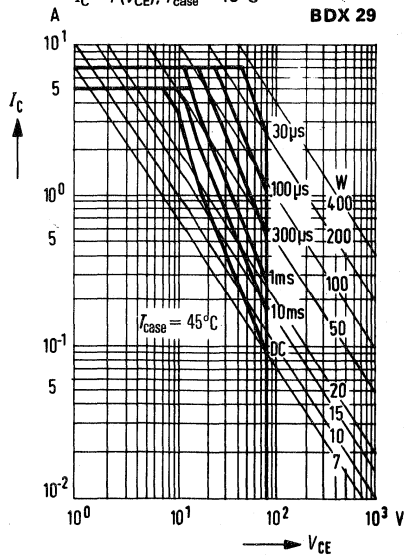

Permissible operating range
 $I_C = f(V_{CE}); T_{case} = 45^\circ C$

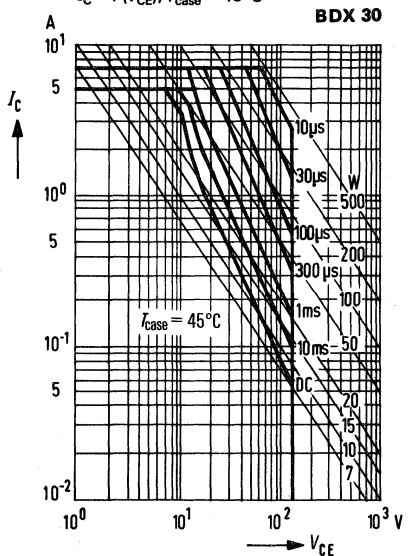

BDX 27
BDX 28
BDX 29
BDX 30

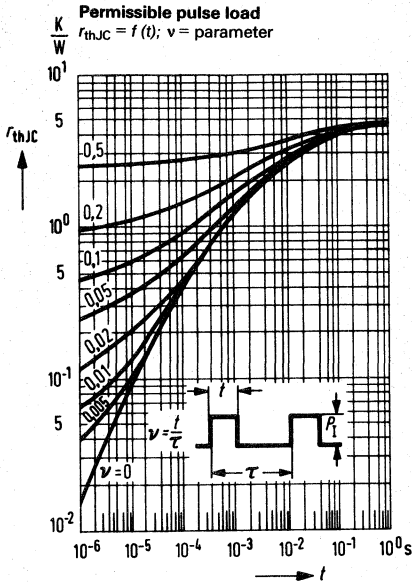

DC current gain $h_{FE} = f(I_C)$
 $T_{case} = \text{parameter}$

BDX 27-6, BDX 28-6
BDX 29-6, BDX 30-6

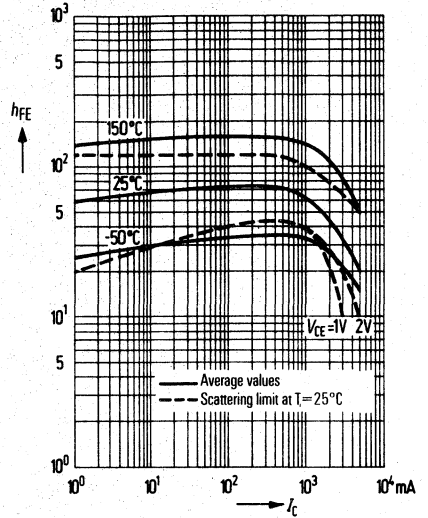

DC current gain $h_{FE} = f(I_C)$
 $T_{case} = \text{parameter}$

BDX 27-10, BDX 28-10
BDX 29-10, BDX 30-10

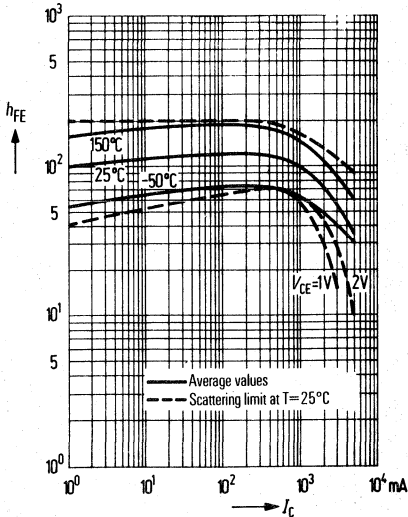

Collector-emitter saturation voltage

$V_{CEsat} = f(I_C); h_{FE} = 10$
 $T_{case} = \text{parameter}$

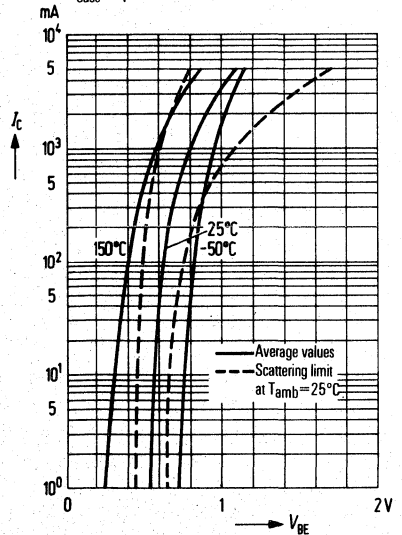

for gain-controlled TV IF amplifier stages

BF 198 is an NPN silicon planar radio-frequency transistor in TO 92 plastic package (10 A 3 DIN 41868). The transistor is characterized by a low reverse transfer capacitance and is recommended for use in gain-controlled IF amplifier stages of TV sets in common-emitter configuration.

Type	Ordering code
BF 198	Q62702-F354

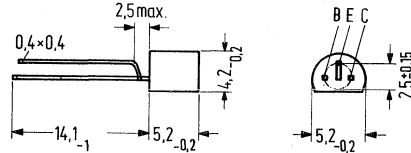

Approx. weight 0.25 g

Dimensions in mm

Maximum ratings

Collector-emitter-voltage	V_{CEO}	30	V
Collector-base voltage	V_{CBO}	40	V
Base-emitter voltage	V_{EBO}	4	V
Collector current	I_C	25	mA
Base current	I_B	3	mA
Junction temperature	T_j	150	°C
Storage temperature range	T_{stg}	-55 to +150	°C
Total power dissipation ($T_{amb} \leq 25^\circ\text{C}$)	P_{tot}	500	mW

Thermal resistance

Junction to ambient air	R_{thJA}	≤ 250	K/W
-------------------------	------------	------------	-----

Static characteristics ($T_{amb} = 25^{\circ}\text{C}$)

Collector cutoff current ($V_{CB} = 40\text{ V}$)	I_{CBO}	< 100	nA
DC current gain ($V_{CE} = 10\text{ V}; I_C = 4\text{ mA}$)	h_{FE}	70 (>26)	-
($V_{CE} = 3\text{ V}; I_C = 10\text{ mA}$)	h_{FE}	> 10	-
Base-emitter voltage ($V_{CE} = 10\text{ V}; I_C = 4\text{ mA}$)	V_{BE}	750	mV

Dynamic characteristics ($T_{amb} = 25^{\circ}\text{C}$)

Transition frequency ($V_{CE} = 10\text{ V}; I_C = 4\text{ mA}; f = 100\text{ MHz}$)	f_T	400	MHz
Reverse transfer capacitance ($V_{CE} = 10\text{ V}; I_C = 1\text{ mA}; f = 1\text{ MHz}$)	$-C_{12e}$	0.22	pF
Noise figure ($V_{CE} = 10\text{ V}; I_C = 4\text{ mA}; f = 35\text{ MHz}; R_g = 100\ \Omega$)	NF	3	dB
Obtainable power gain ($V_{CE} = 10\text{ V}; I_C = 4\text{ mA}; f = 35\text{ MHz}$)	$G_{peopt}^{1)}$	42	dB

Four-pole characteristics: ($V_{CE} = 10\text{ V}; I_C = 4\text{ mA}; f = 35\text{ MHz}$)

$g_{11e} = 4,5\text{ mS}$	$[y_{12e}] = 47\ \mu\text{S}$	$[y_{21e}] = 105\text{ mS}$	$g_{22e} = 40\ \mu\text{S}$
$c_{11e} = 40\text{ pF}$	$-\varphi_{12e} = 95^{\circ}$	$-\varphi_{21e} = 20^{\circ}$	$c_{22e} = 1,3\text{ pF}$

¹⁾ $G_{peopt} = \frac{|y_{21e}|^2}{4g_{11e} \cdot g_{22e}}$

Total perm. power dissipation versus temperature
 $P_{tot} = f(T_{amb})$

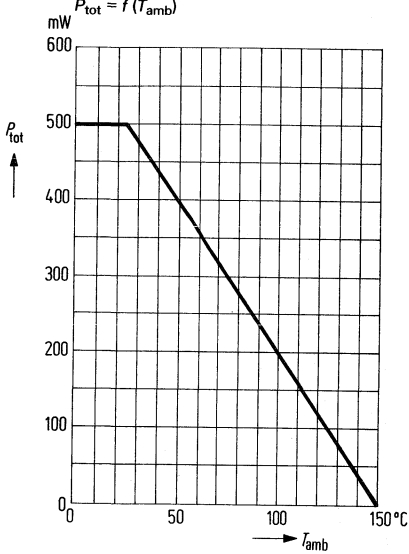

Collector current $I_C = f(I_B)$

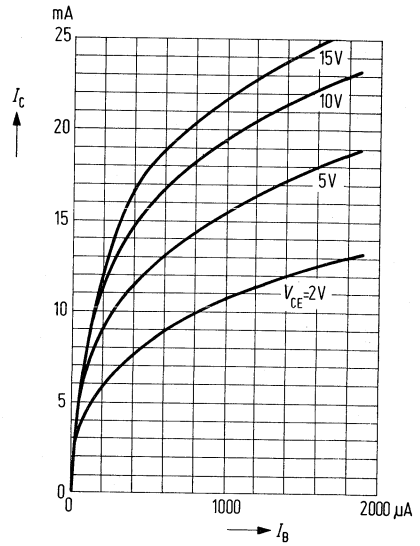

Input characteristic $I_C = f(V_{BE})$
 $V_{CE} = 10V$

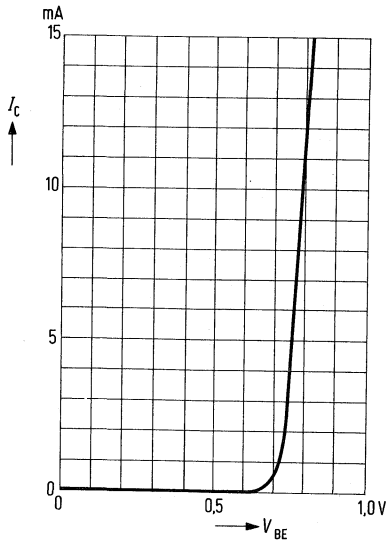

Output characteristics $I_C = f(V_{CE})$
 $I_B = \text{parameter}$

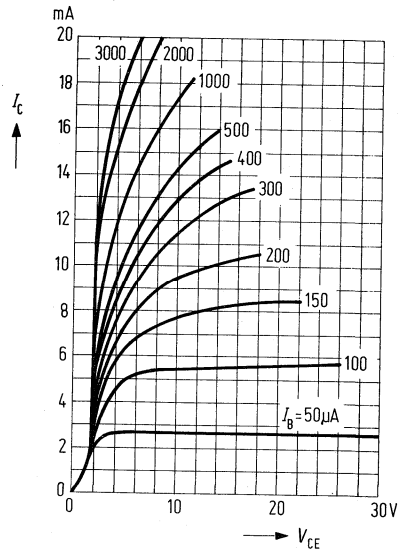

Transition frequency $f_T = f(I_C)$
 $V_{CE} = \text{parameter}$

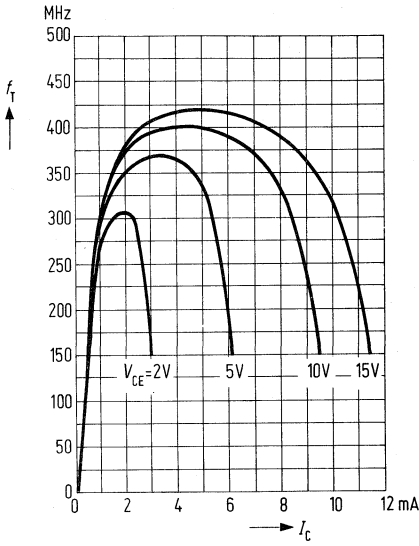

Short-circuit forward transfer admittance $y_{21e} = f(I_C)$
 $V_{CE} = \text{parameter}; f = 35 \text{ MHz}$

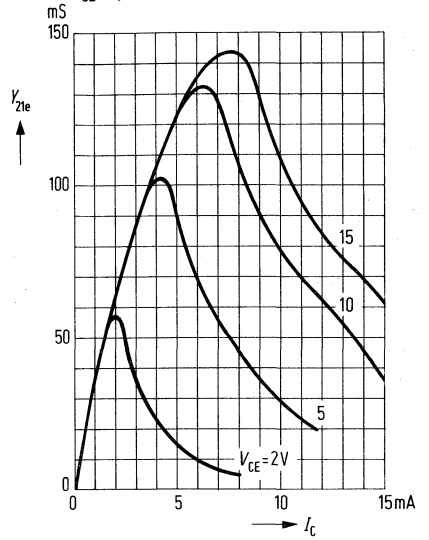

Constant power gain characteristics

$I_C = f(V_{CE})$
 $\Delta G_{pe} = \text{parameter}; f = 36.4 \text{ MHz}$

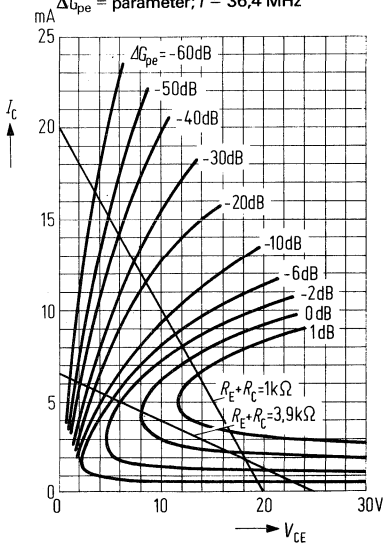

Power gain control range

$\Delta G_{pe} = f(V_{CE}); R_E + R_C = 3.9 \text{ k}\Omega;$
 $f = 36.4 \text{ MHz}; -V_{EE} = 25 \text{ V}$

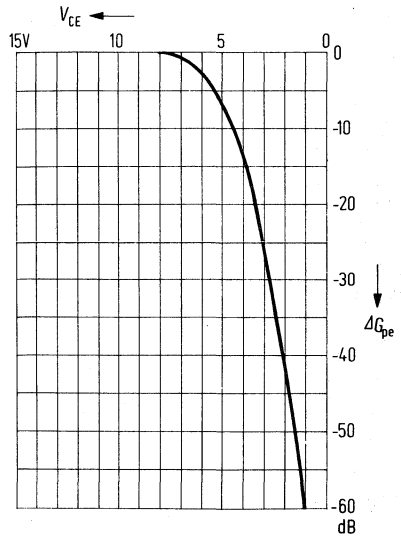

Control range of power gain

$\Delta G_{pe} = f(I_C); R_E + R_C = 1 \text{ k}\Omega;$
 $-V_{EE} = 20 \text{ V}; f = 36.4 \text{ MHz}$

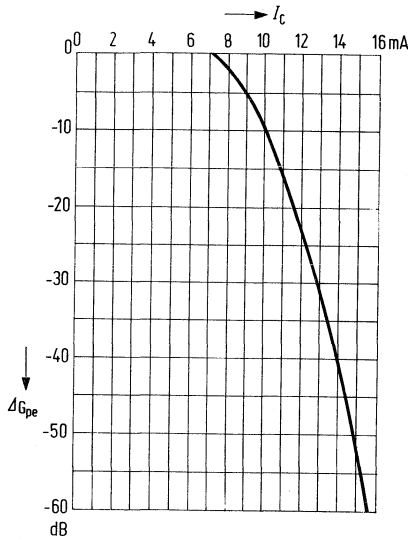

Reverse transfer capacitance

$C_{12e} = f(V_{CE}); I_C = 1 \text{ mA}; f = 1 \text{ MHz}$

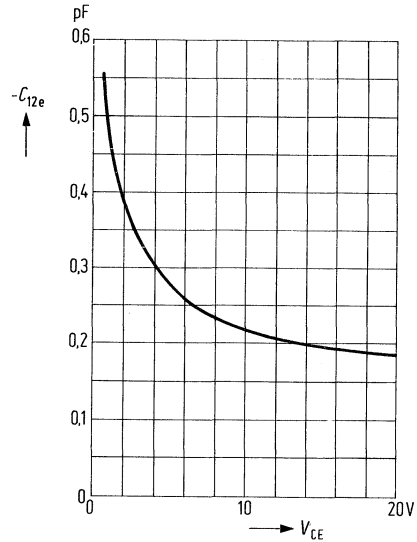

First stage of a TV IF amplifier incl. voltage gain control $f = 36.4 \text{ MHz}$.

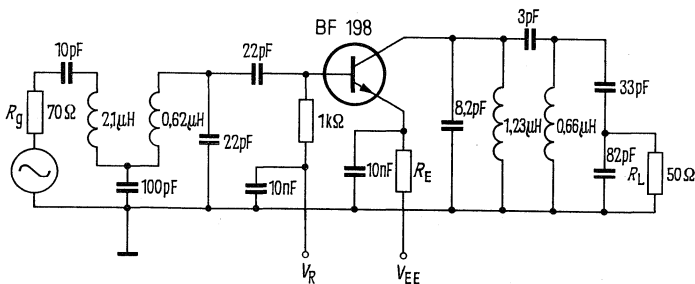

Power gain ($I_C = 4 \text{ mA};$
 $-V_{EE} = 25 \text{ V}; R_E + R_C = 3.9 \text{ k}\Omega$)
 Gain control range

G_p	26	dB
ΔG_p	60	dB

for TV IF stages

BF 199 is an epitaxial NPN silicon planar high-frequency transistor in TO 92 plastic package (10 A 3 DIN 41868). The transistor is characterized by a low reverse transfer capacitance and is recommended for use in uncontrolled IF amplifier stages of TV sets in common-emitter configuration.

Type	Ordering code
BF 199	Q62702-F355

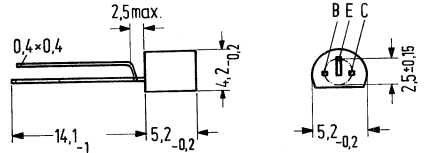

Approx. weight 0.25 g

Dimensions in mm

Maximum ratings

Collector-emitter voltage	V_{CE0}	25	V
Collector-base voltage	V_{CBO}	40	V
Base-emitter-voltage	V_{EBO}	4	V
Collector current	I_C	25	mA
Base current	I_B	2	mA
Junction temperature	T_j	150	°C
Storage temperature range	T_{stg}	-55 to +150	°C
Total power dissipation ($T_{amb} \leq 25^\circ\text{C}$)	P_{tot}	500	mW

Thermal resistance

Junction to ambient air	R_{thJA}	≤ 250	K/W
-------------------------	------------	------------	-----

Static characteristics ($T_{amb} = 25^\circ\text{C}$):

Collector cutoff current ($V_{CB} = 40\text{ V}$)	I_{CBO}	< 100	nA
DC current gain ($V_{CE} = 10\text{ V}; I_C = 7\text{ mA}$)	h_{FE}	85 (> 38)	-
Base-emitter voltage ($V_{CE} = 10\text{ V}; I_C = 7\text{ mA}$)	V_{BE}	780	mV

Dynamic characteristics ($T_{amb} = 25^{\circ}\text{C}$)

Transition frequency

($V_{CE} = 10\text{ V}$; $I_C = 5\text{ mA}$; $f = 100\text{ MHz}$)

f_T	550	MHz
-------	-----	-----

Reverse transfer capacitance

($V_{CE} = 10\text{ V}$; $I_C = 1\text{ mA}$; $f = \text{MHz}$)

C_{12e}	0.32	pF
-----------	------	----

Obtainable power gain

($V_{CE} = 10\text{ V}$; $I_C = 7\text{ mA}$; $f = 35\text{ MHz}$)

$G_{pe\text{ opt}}^1)$	43	dB
------------------------	----	----

Four-pole characteristics: ($V_{CE} = 10\text{ V}$; $I_C = 7\text{ mA}$; $f = 35\text{ MHz}$)

$g_{11e} = 4,8\text{ mS}$

$c_{11e} = 45\text{ pF}$

$[y_{12e}] = 70\text{ }\mu\text{S}$

$-\varphi_{12e} = 95^{\circ}$

$[y_{21e}] = 175\text{ mS}$

$-\varphi_{21e} = 25^{\circ}$

$g_{22e} = 80\text{ }\mu\text{S}$

$c_{22e} = 1,7\text{ pF}$

TV IF amplifier using a BF 199

(all circuits are tuned to 37 MHz).

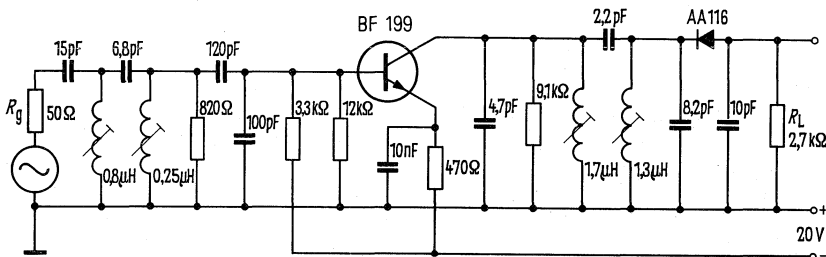

Power gain

($V_{CE} = 16.6\text{ V}$; $I_C = 7.2\text{ mA}$; $f = 36.4\text{ MHz}$)

G_p	26	dB
-------	----	----

Output voltage

($V_{CE} = 16.6\text{ V}$; $I_C = 7.2\text{ mA}$; $f = 39.9\text{ MHz}$)

$V_A^2)$	7.7 (>6)	V
----------	----------	---

$$1) G_{pe\text{ opt}} = \frac{|y_{21e}|^2}{4 g_{11e} \cdot g_{22e}}$$

2) Voltage across the 2.7 k ohm load resistor at 30% synchronous pulse compression.

Total perm. power dissipation versus temperature

$P_{tot} = f(T_{amb})$

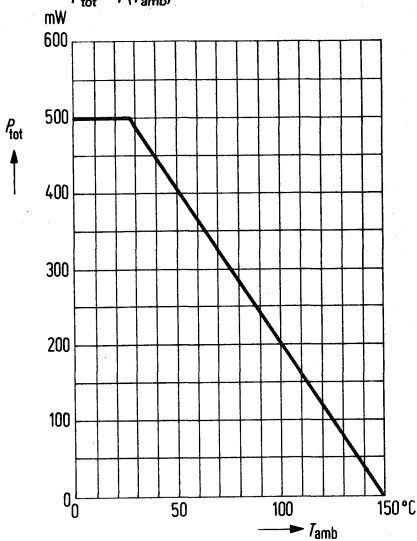

Min.-limit characteristic of collector-emitter breakdown voltage

$V_{(BR)CER} = f(R_B)$

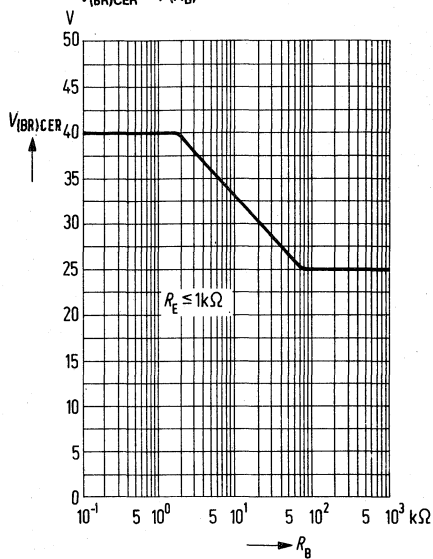

Collector current $I_C = f(V_{BE})$

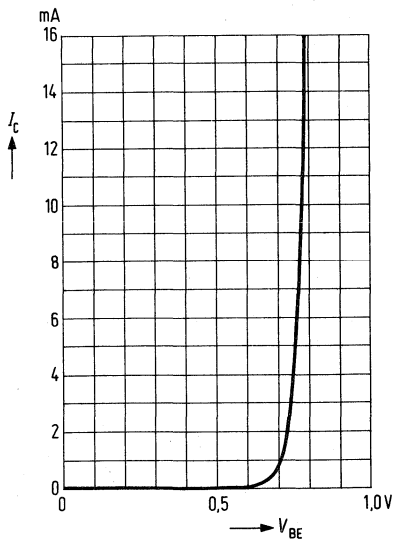

Collector current $I_C = f(I_B)$

$V_{CE} = \text{parameter}$

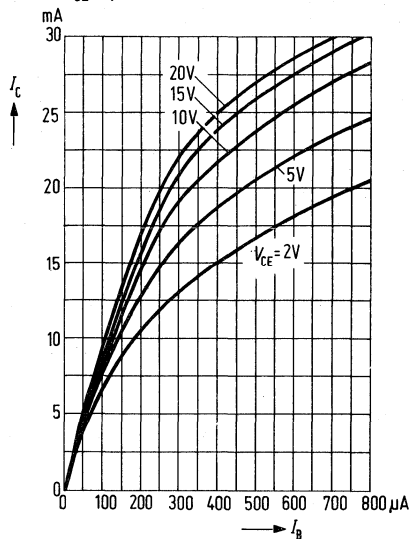

Output characteristics $I_C = f(V_{CE})$
 $I_B = \text{parameter}$

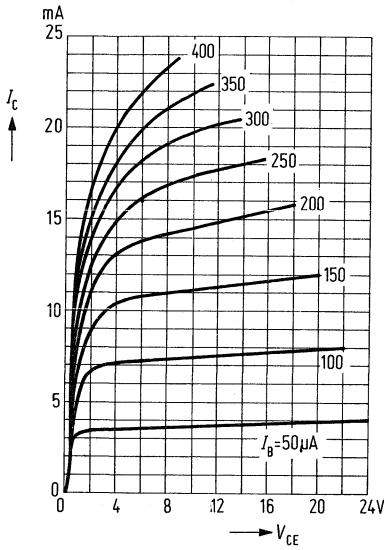

Short-circuit reverse transfer capacitance $-C_{12e} = f(V_{CE})$
 $I_C = 1\text{ mA}, f = 1\text{ MHz}$

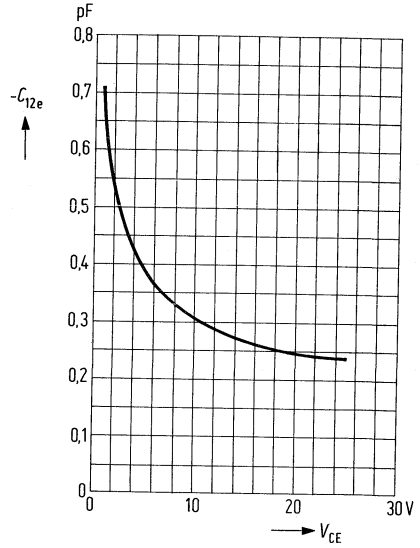

Small-signal short-circuit forward transfer admittance
 $|y_{21e}| = f(I_C)$
 $V_{CE} = \text{parameter}; f = 35\text{ MHz}$

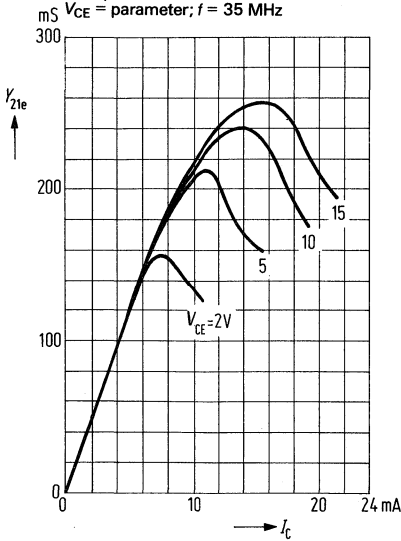

Transition frequency $f_T = f(I_C)$
 $V_{CE} = \text{parameter}, f = 100\text{ MHz}$

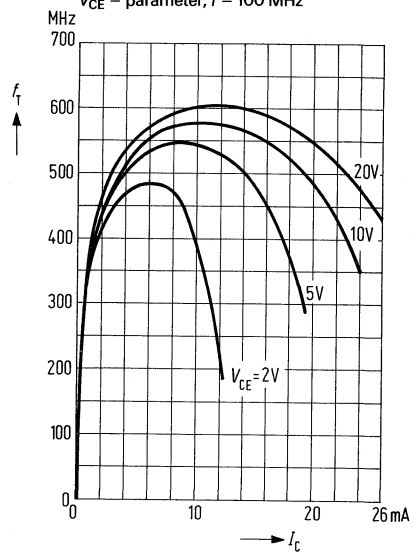

for radio receiver stages

BF 240 and BF 241 are epitaxial NPN silicon planar transistors in TO 92 plastic package (10 A 3 DIN 41868). They are especially suitable for use in AM/FM IF stages, the BF 240 being designed for gain controlled stages and the BF 241 for uncontrolled stages.

Type	Ordering code
BF 240	Q62702-F302
BF 241	Q62702-F303

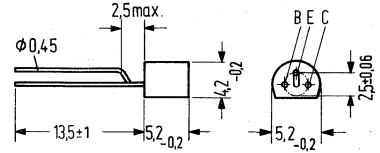

Approx. weight 0.25 g Dimensions in mm

Maximum ratings

	BF 240	BF 241	
Collector-emitter voltage	40	40	V
Collector-base voltage	40	40	V
Emitter-base voltage	4	4	V
Collector current	25	25	mA
Base current	2	2	mA
Junction temperature	150	150	°C
Storage temperature range	-55 to +150		°C
Total power dissipation ($T_{amb} = 45^{\circ}\text{C}$)	250	250	mW

Thermal resistance

Junction to ambient air	R_{thJA}	<420	<420	K/W
-------------------------	------------	------	------	-----

Static characteristics ($T_{amb} = 25^{\circ}\text{C}$)

Collector cutoff current ($V_{CB} = 20\text{ V}$)	I_{CBO}	<100	<100	nA
Collector-base voltage ($I_C = 10\ \mu\text{A}$)	V_{CBO}	>40	>40	V
Emitter-base voltage ($I_E = 10\ \mu\text{A}$)	V_{EBO}	>4	>4	V
Base voltage ($I_C = 1\text{ mA}$; $V_{CE} = 10\text{ V}$)	V_{BE}	700	700	mV
Base current ($I_C = 1\text{ mA}$; $V_{CE} = 10\text{ V}$)	I_B	4.5 to 15	8 to 28	μA

Dynamic characteristics ($T_{amb} = 25^{\circ}\text{C}$)	BF 240	BF 241	
Transition frequency ($I_C = 1\text{ mA}$; $V_{CE} = 10\text{ V}$)	400	400	MHz
Noise figure $I_C = 1\text{ mA}$ $V_{CE} = 10\text{ V}$; $f = 100\text{ kHz}$; $R_g = 300\ \Omega$)			
Reverse transfer capacitance ($I_C = 1\text{ mA}$; $V_{CB} = 10\text{ V}$)	<0.34	<0.34	pF
Short-circuit output admittance			
($I_C = 1\text{ mA}$; $V_{CE} = 10\text{ V}$; $f = 10.7\text{ MHz}$)	g_{22e}	<10.5	μS
($I_C = 1\text{ mA}$; $V_{CE} = 10\text{ V}$; $f = 0.5\text{ MHz}$)	g_{22e}	<8.3	μS

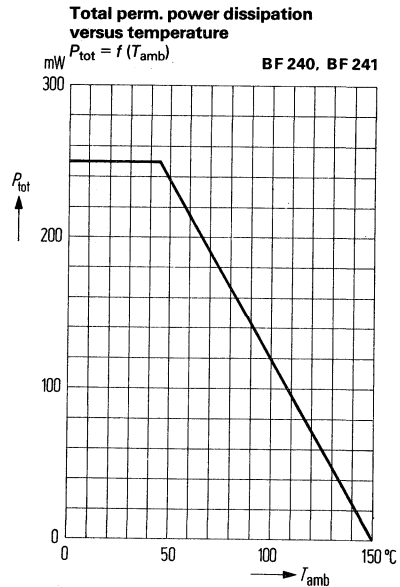

N-Channel Junction Field-Effect Transistors

BF 245 A
BF 245 B
BF 245 C

BF 245 A, B, and C are N-channel junction field-effect transistors in plastic package similar to TO 92 (10 A 3 DIN 41868). They are particularly suitable for use in dc, AF and RF amplifiers.

Type	Ordering code
BF 245	Q62702-F236
BF 245 A	Q62702-F209
BF 245 B	Q62702-F182
BF 245 C	Q62702-F205

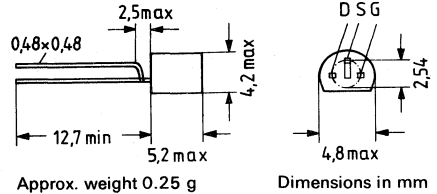

Maximum ratings

Drain-source voltage	$\pm V_{DS}$	30	V
Drain-gate voltage ($I_S = 0$)	$+V_{DG}$	30	V
Gate-source voltage ($I_D = 0$)	$-V_{GS}$	30	V
Drain current	I_D	25	mA
Gate current	I_G	10	mA
Junction temperature	T_j	150	°C
Storage temperature range	T_{stg}	-65 to +150	°C
Total power dissipation ($T_{amb} \leq 75^\circ\text{C}$) ¹⁾	P_{tot}	300	mW

Thermal resistance

Junction to ambient air	R_{thJA}	≤ 250	K/W ¹⁾
-------------------------	------------	------------	-------------------

1) If the transistors with max 3 mm lead length are fixed on PCBs with a 10 mm x 10 mm large copper area for the drain terminal, $R_{thJA} = 2 \text{ K/W}$, $P_{tot} = \text{max. } 300 \text{ mW}$ then applies up to $T_{amb} = 90^\circ\text{C}$.

Static characteristics ($T_j = 25^\circ\text{C}$)

Gate cutoff current

($-V_{GS} = 20\text{ V}$, $V_{DS} = 0$)
($-V_{GS} = 20\text{ V}$, $V_{DS} = 0$, $T_j = 125^\circ\text{C}$)

$-I_{GS\ S}$	≤ 5	nA
$-I_{GS\ S}$	≤ 500	nA

Gate-source breakdown voltage
($-I_G = 1\ \mu\text{A}$, $V_{DS} = 0$)

$-V_{(BR)GS\ S}$	≥ 30	V
------------------	-----------	---

Drain-source short-circuit current
($V_{DS} = 15\text{ V}$, $V_{GS} = 0$)

BF 245 A: $I_{DS\ S}$	2.0 to 6.5	$\text{mA}^{2)}$
BF 245 B: $I_{DS\ S}$	6 to 15	mA
BF 245 C: $I_{DS\ S}$	12 to 25	mA

Gate-source voltage

($V_{DS} = 15\text{ V}$, $I_D = 200\ \mu\text{A}$)

BF 245 A: $-V_{GS}$	0.4 to 2.2	$\text{V}^{2)}$
BF 245 B: $-V_{GS}$	1.6 to 3.8	V
BF 245 C: $-V_{GS}$	3.2 to 7.5	V

Gate-source pinch-off voltage

($V_{DS} = 15\text{ V}$, $I_D = 10\text{ nA}$)

$-V_P$	0.5 to 8.0	V
--------	------------	---

Dynamic characteristics ($T_{amb} = 25^\circ\text{C}$)

Four-pole characteristics

($V_{DS} = 15\text{ V}$, $V_{GS} = 0$, $f = 1\text{ kHz}$)

$ y_{21s} $	3.0 to 6.5	mS
$ y_{22s} $	25	μS
g_{11}	250	μS
$ y_{21s} $	6	mS
g_{22s}	40	μS
C_{11s}	4.0	pF
C_{12s}	1.1	pF
C_{22s}	1.6	pF

($V_{DS} = 15\text{ V}$, $V_{GS} = 0$, $f = 200\text{ MHz}$)

($V_{DS} = 20\text{ V}$, $-V_{GS} = 1\text{ V}$, $f = 1\text{ MHz}$)

Cutoff frequency of

short-circuit forward transfer admittance¹⁾

($V_{DS} = 15\text{ V}$, $V_{GS} = 0$)

Noise figure

($V_{DS} = 15\text{ V}$, $V_{GS} = 0$, $R_g = 1\text{ k}\Omega$,
 $f = 100\text{ MHz}$, $T_{amb} = 25^\circ\text{C}$)

f_{y21s}	700	MHz
NF	1.5	dB

1) Frequency for a decrease in the small-signal short-circuit forward transfer admittance to 70% of the value at 1 kHz.

2) BF 245 A1: $I_{DS\ S} = 2.0$ to 3.0 mA , $-V_{GS} = 0.4$ to 1.0 V
BF 245 A2: $I_{DS\ S} = 3.0$ to 4.5 mA , $-V_{GS} = 0.7$ to 1.4 V
BF 245 A3: $I_{DS\ S} = 4.5$ to 6.5 mA , $-V_{GS} = 1.1$ to 2.2 V

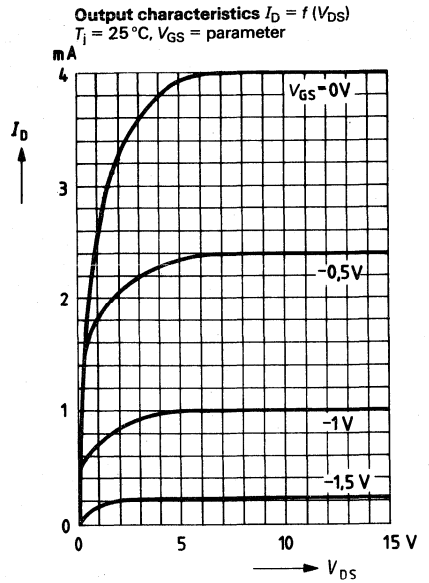
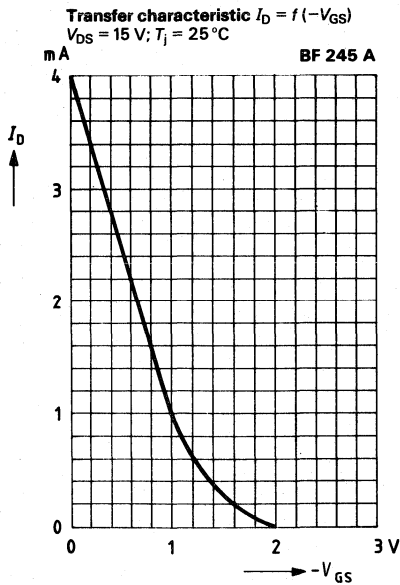
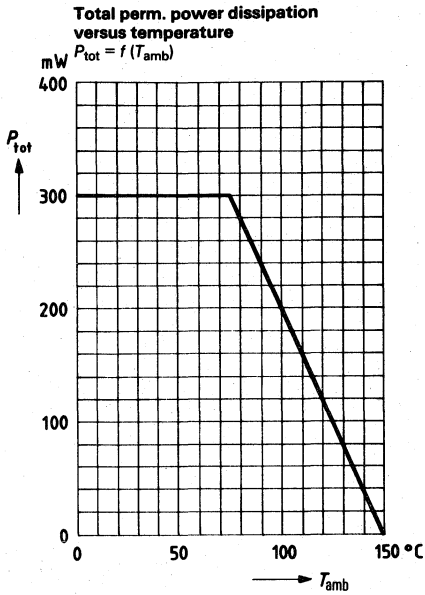

BF 245 A
BF 245 B
BF 245 C

Transfer characteristic $I_D = f(-V_{GS})$
 $V_{DS} = 15 \text{ V}; T_j = 25^\circ\text{C}$

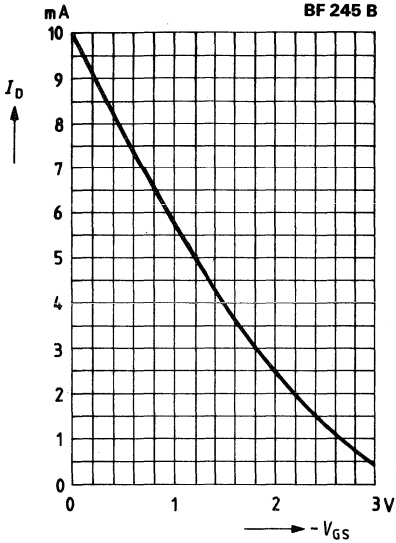

Output characteristics $I_D = f(V_{DS})$
 $V_{GS} = \text{parameter}; T_j = 25^\circ\text{C}$

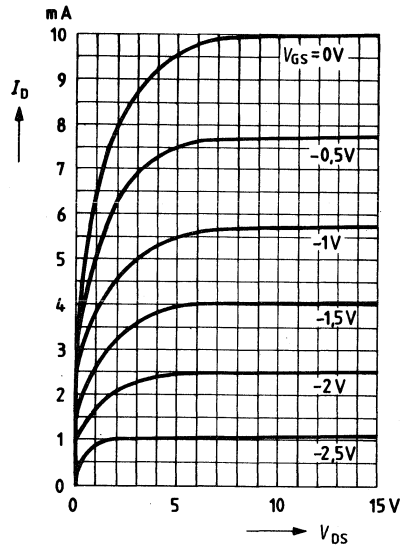

Transfer characteristic $I_D = f(-V_{GS})$
 $V_{DS} = 15 \text{ V}; T_j = 25^\circ\text{C}$

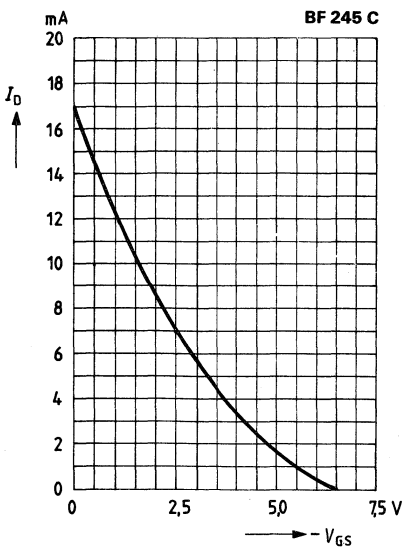

Output characteristics $I_D = f(V_{DS})$
 $V_{GS} = \text{parameter}; T_j = 25^\circ\text{C}$

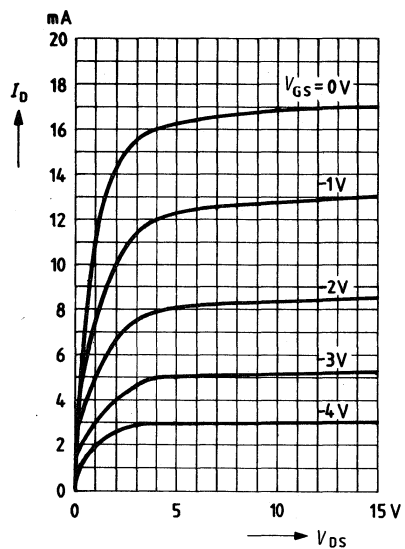

BF 245 A
BF 245 B
BF 245 C

Drain current versus temperature

$I_D = f(T_j)$; $V_{GS} = \text{parameter}$; $V_{DS} = 15 \text{ V}$

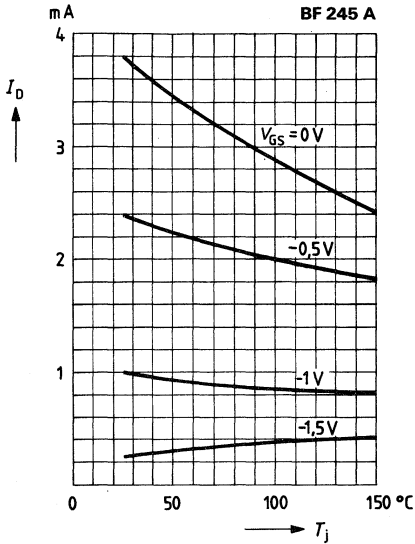

Drain current versus temperature

$I_D = f(T_j)$; $V_{GS} = \text{parameter}$; $V_{DS} = 15 \text{ V}$

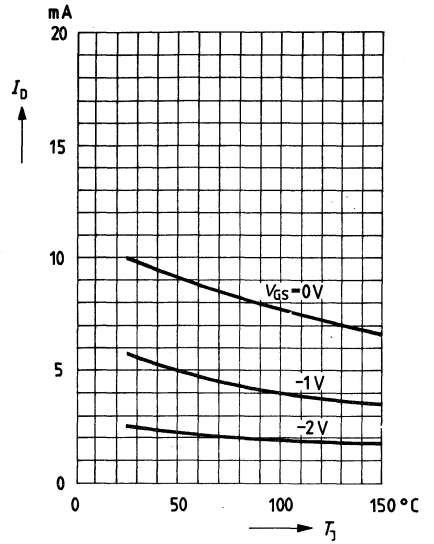

Drain current versus temperature

$I_D = f(T_j)$; $V_{GS} = \text{parameter}$; $V_{DS} = 15 \text{ V}$

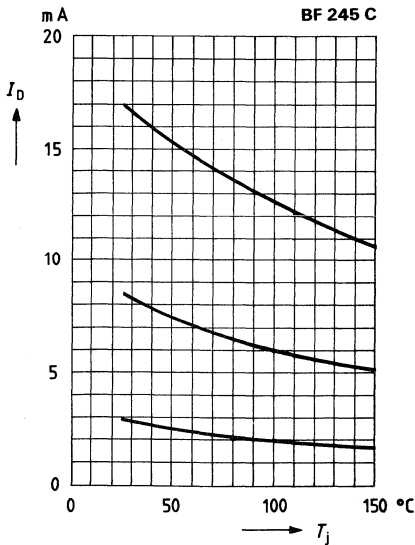

Correlation between V_p and I_{DSS}

$V_{DS} = 15 \text{ V}$, $I_D = 10 \text{ mA}$; $T_j = 25 \text{ °C}$

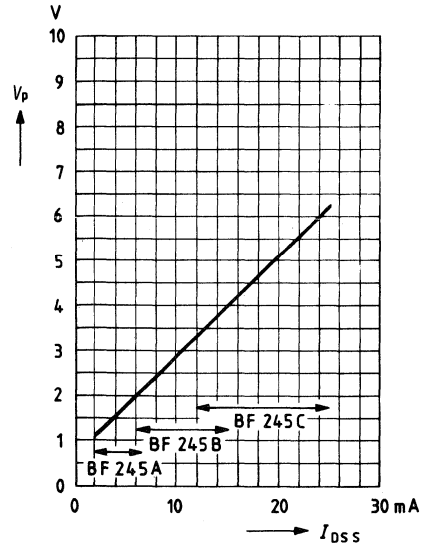

Input characteristics $C_{11S} = f(-V_{GS})$

$V_{DS} = 20\text{ V}; f = 1\text{ MHz}; T_{amb} = 25^\circ\text{C}$

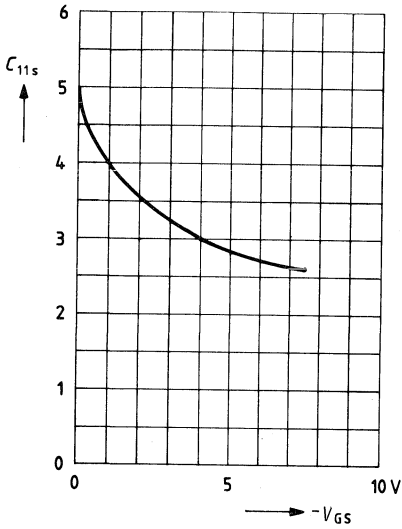

Reverse transfer capacitance

$C_{12S} = f(-V_{GS}); V_{DS} = 20\text{ V};$

$f = 1\text{ MHz}; T_{amb} = 25^\circ\text{C}$

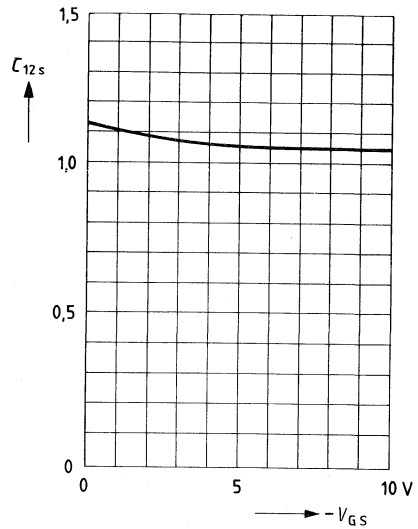

Reverse current versus temperature

$-I_{GSS} = f(T_j); -V_{GS} = 20\text{ V}; V_{DS} = 0$

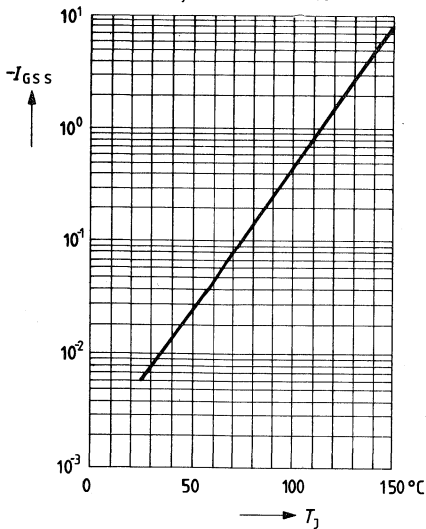

Dynamic drain-source resistance

$r_{DS} = f(-V_{GS}); V_{DS} = 0;$

$f = 1\text{ kHz}; T_{amb} = 25^\circ\text{C}$

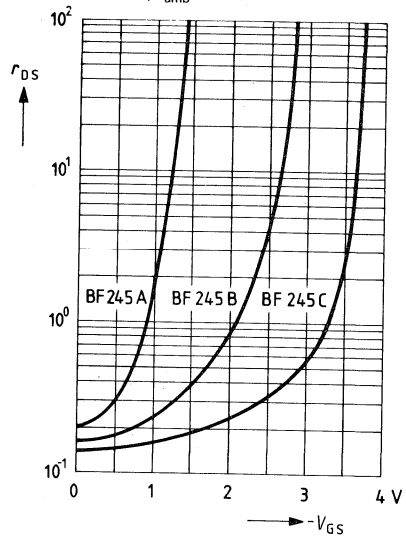

BF 245 A
BF 245 B
BF 245 C

Small-signal short-circuit forward transfer admittance $y_{21s} = f(I_D)$

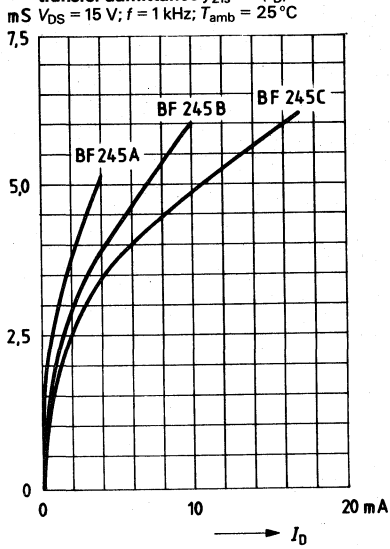

Noise figure $NF = f(f)$

$V_{DS} = 15 \text{ V}; V_{GS} = 0;$
 $R_g = 1 \text{ k}\Omega, T_{amb} = 25^\circ\text{C}$

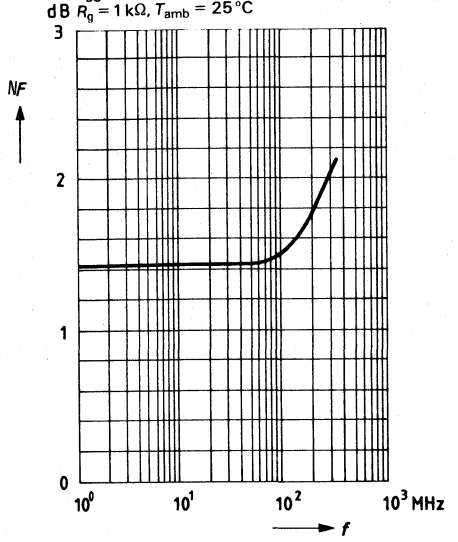

N-Channel Junction Field-Effect Transistors

BF 246 A
BF 246 B
BF 246 C

BF 246 A, B, and C are N-channel junction field-effect transistors in plastic package similar to TO 92 (10 A 3 DIN 41868). They are particularly suitable for RF amplifiers.

Type	Ordering code
BF 246	Q62702-F219
BF 246 A	Q62702-F393
BF 246 B	Q62702-F254
BF 246 C	Q62702-F250

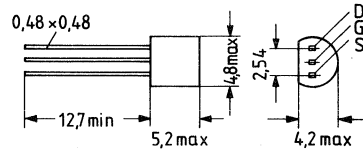

Approx. weight 0,25 g
 Dimensions in mm

Maximum ratings

Drain-source voltage	$\pm V_{DS}$	25	V
Drain-gate voltage ($I_S = 0$)	$+V_{DGO}$	25	V
Gate-source voltage ($I_D = 0$)	$-V_{GSO}$	25	V
Gate current	I_G	10	mA
Junction temperature	T_j	150	$^{\circ}\text{C}$
Storage temperature range	T_{stg}	-65 to 150	$^{\circ}\text{C}$
Total power dissipation ($T_{amb} \leq 75^{\circ}\text{C}$) ¹⁾	P_{tot}	300	mW

Thermal resistance

Junction to ambient air ¹⁾	R_{thJA}	250	K/W
---------------------------------------	------------	-----	-----

1) If the transistors with max 3 mm lead length are fixed on PCBs with a 10 mm x 10 mm large copper area for the drain terminal, $R_{thJA} \leq 2 \text{ K/W}$, $P_{tot} = \text{max. } 300 \text{ mW}$ then applies up to $T_{amb} = 90^{\circ}\text{C}$.

Static characteristics ($T_{amb} = 25^{\circ}\text{C}$)

Gate cutoff current ($-V_{GS} = 15\text{ V}, V_{DS} = 0$)	$-I_{GS}$	≤ 5	mA
Gate-source breakdown voltage ($-I_G = 1\ \mu\text{A}, V_{DS} = 0$)	$-V_{(BR)GS}$	≥ 25	V
Drain-source short-circuit current ($V_{DS} = 15\text{ V}, V_{GS} = 0$)	BF 246 A: I_{DSS}	30 to 80	mA
	BF 246 B: I_{DSS}	60 to 140	mA
	BF 246 C: I_{DSS}	110 to 250	mA
Gate-source voltage ($V_{DS} = 15\text{ V}, I_D = 200\ \mu\text{A}$)	$-V_{GS}$	0.5 to 14	V
	BF 246 A: $-V_{GS}$	1.5 to 4.0	V
	BF 246 B: $-V_{GS}$	3.0 to 7.0	V
	BF 246 C: $-V_{GS}$	5.5 to 12	V
Gate-source pinch-off voltage ($V_{DS} = 15\text{ V}, I_D = 10\ \text{nA}$)	$-V_P$	0.6 to 14.5	V

Dynamic characteristics ($T_{amb} = 25^{\circ}\text{C}$)

Small signal short circuit forward transfer admittance ($V_{DS} = 15\text{ V}, I_D = 10\ \text{mA}, f = 1\ \text{kHz}$)	$ y_{21s} $	23 (≥ 8)	mS
Cutoff frequency of small-signal short-circuit forward transfer admittance ¹⁾ ($V_{DS} = 15\text{ V}, V_{GS} = 0$)	f_{y21s}	450	MHz
Capacitances ($V_{DS} = 15\text{ V}, I_D = 10\ \text{mA}$) $f = 1\ \text{MHz}$:	C_{11s}	15	pF
	C_{22s}	15	pF
$f = 1\ \text{kHz}$:	$-C_{12s}$	3.5	pF

1) Frequency for a decrease in the small-signal short-circuit forward transfer admittance to 70% of the value at 1 kHz.

Total perm. power dissipation
versus temperature

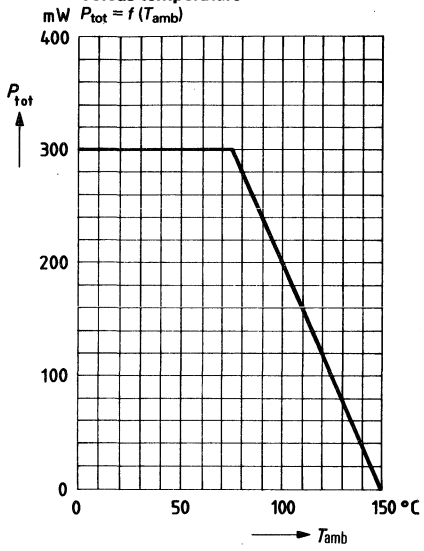

for applications up to the VHF range

BF 254 and BF 255 are epitaxial NPN silicon planar high-frequency transistors in TO 92 plastic package (10 A 3 DIN 41868).

BF 254: This transistor is designed for use in AM/FM-IF amplifiers as well as for input stages in the short, medium and long-wave ranges.

BF 255: This transistor is designed for use in input stages as well as in mixer and oscillator stages up to the VHF range.

Type	Ordering code
BF 254	Q62702-F201
BF 255	Q62702-F202

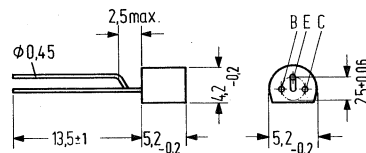

Approx. weight 0.25 g Dimensions in mm

Maximum ratings

	BF 254	BF 255	
Collector-base voltage	V_{CBO} 30	30	V
Collector-emitter voltage	V_{CEO} 20	20	V
Emitter-base voltage	V_{EBO} 5	5	V
Collector current	I_C 30	30	mA
Junction temperature	T_j 125	125	°C
Storage temperature range	T_{stg}	-65 to +125	°C
Total power dissipation	P_{tot} 220	220	mW

Thermal resistance

Junction to ambient air	R_{thJA} ≤ 450	≤ 450	K/W
-------------------------	------------------	-------	-----

Static characteristics ($T_{amb} = 25^\circ\text{C}$)

Base-emitter voltage ($V_{CE} = 10\text{ V}; I_C = 1\text{ mA}$)	V_{BE} 0.68	0.68	V
Base current ($V_{CE} = 10\text{ V}; I_C = 1\text{ mA}$)	I_B 8.7 (4.5 to 15)	15 (8 to 28)	μA
DC current gain ($V_{CE} = 10\text{ V}; I_C = 1\text{ mA}$)	h_{FE} 115	67	-

Dynamic characteristics ($T_{amb} = 25^{\circ}\text{C}$)		BF 254	BF 255		
Transition frequency ($V_{CE} = 10\text{ V}; I_C = 1\text{ mA}$)		f_T	260	200	MHz
Noise figure ($V_{CE} = 10\text{ V}; I_C = 1\text{ mA}$)					
at $f = 200\text{ kHz}, g_g = 2\text{ mS}^1$		NF	1.5	–	dB
at $f = 1\text{ MHz}, g_g = 1.5\text{ mS}^1$		NF	1.2	–	dB
at $f = 1\text{ MHz}, g_g = 20\text{ mS}^1$		NF	–	3.5	dB
at $f = 100\text{ MHz}, g_g = 10\text{ mS}^1$		NF	4	4	dB
Mixed noise figure ($V_{CE} = 10\text{ V}; I_C = 1\text{ mA}$)					
at $f = 200\text{ kHz}, g_g = 0.6\text{ mS}^1$		NF_C	3	–	dB
at $f = 1\text{ MHz}, g_g = 1.2\text{ mS}^1$		NF_C	2	–	dB
at $f = 200\text{ kHz}, g_g = 1.2\text{ mS}^1$		NF_C	–	4	dB
at $f = 1\text{ MHz}, g_g = 1.5\text{ mS}^1$		NF_C	–	2.5	dB
Reverse transfer capacitance $V_{CE} = 10\text{ V}; I_C = 1\text{ mA}; f = 450\text{ kHz}$		$-C_{12e}$	0.85	0.85	pF

Dynamic characteristics ($T_{amb} = 25^{\circ}\text{C}$) BF 254

Four-pole characteristics

Operating point: ($V_{CE} = 10\text{ V}; I_C = 1\text{ mA}$)

$$f = 450\text{ kHz: } \begin{array}{l} g_{11e} = 0,33\text{ mS} \\ b_{11e} = 0,065\text{ mS} \\ C_{11e} = 23\text{ pF} \end{array} \left. \begin{array}{l} |y_{12e}| = 2,8\text{ }\mu\text{S} \\ -\varphi_{12e} = 90^{\circ} \end{array} \right\} \left. \begin{array}{l} |y_{21e}| = 36\text{ mS} \\ -\varphi_{21e} = 0^{\circ} \end{array} \right\} \begin{array}{l} g_{22e} = 6\text{ }\mu\text{S} \\ b_{22e} = 4,5\text{ }\mu\text{S} \\ C_{22e} = 1,6\text{ pF} \end{array}$$

$$f = 10,7\text{ MHz: } \begin{array}{l} g_{11e} = 0,45\text{ mS} \\ b_{11e} = 1,5\text{ mS} \\ C_{11e} = 22\text{ pF} \end{array} \left. \begin{array}{l} |y_{12e}| = 65\text{ }\mu\text{S} \\ -\varphi_{12e} = 90^{\circ} \end{array} \right\} \left. \begin{array}{l} |y_{21e}| = 36\text{ mS} \\ -\varphi_{21e} = 10^{\circ} \end{array} \right\} \begin{array}{l} g_{22e} = 8,5\text{ }\mu\text{S} \\ b_{22e} = 0,11\text{ mS} \\ C_{22e} = 1,6\text{ pF} \end{array}$$

$$f = 100\text{ MHz: } \begin{array}{l} g_{11b} = 36\text{ mS} \\ -b_{11b} = 3\text{ mS} \\ -C_{11b} = 4,8\text{ pF} \end{array} \left. \begin{array}{l} |y_{12b}| = 420\text{ }\mu\text{S} \\ -\varphi_{12b} = 88^{\circ} \end{array} \right\} \left. \begin{array}{l} |y_{21b}| = 33\text{ mS} \\ -\varphi_{21b} = 146^{\circ} \end{array} \right\} \begin{array}{l} g_{22b} = 22\text{ }\mu\text{S} \\ b_{22b} = 1,1\text{ mS} \\ C_{22b} = 1,75\text{ pF} \end{array}$$

1) g_g = internal admittance of generator $\left(\frac{1}{R_g}\right)$

Dynamic characteristics ($T_{\text{amb}} = 25^\circ\text{C}$) BF 255

Four-pole characteristics

Operating point: ($V_{\text{CE}} = 10\text{ V}$; $I_{\text{C}} = 1\text{ mA}$)

$$f = 450\text{ kHz: } \begin{array}{lll} g_{11e} = 0,5\text{ mS} & |y_{12e}| = 2,6\ \mu\text{S} & |y_{21e}| = 36\text{ mS} \\ b_{11e} = 0,09\text{ mS} & -\varphi_{12e} = 90^\circ & -\varphi_{21e} = 0^\circ \\ C_{11e} = 32\text{ pF} & & \end{array} \quad \begin{array}{l} g_{22e} = 2,7\ \mu\text{S} \\ b_{22e} = 4,5\ \mu\text{S} \\ C_{22e} = 1,6\text{ pF} \end{array}$$

$$f = 10,7\text{ MHz: } \begin{array}{lll} g_{11e} = 0,6\text{ mS} & |y_{12e}| = 60\ \mu\text{S} & |y_{21e}| = 36\text{ mS} \\ b_{11e} = 2,0\text{ mS} & -\varphi_{12e} = 90^\circ & -\varphi_{21e} = 10^\circ \\ C_{11e} = 30\text{ pF} & & \end{array} \quad \begin{array}{l} g_{22e} = 4,5\ \mu\text{S} \\ b_{22e} = 0,11\text{ mS} \\ C_{22e} = 1,6\text{ pF} \end{array}$$

$$f = 100\text{ MHz: } \begin{array}{lll} g_{11b} = 38\text{ mS} & |y_{12b}| = 410\ \mu\text{S} & |y_{21b}| = 34\text{ mS} \\ -b_{11b} = 1\text{ mS} & -\varphi_{12b} = 85^\circ & -\varphi_{21b} = 140^\circ \\ -C_{11b} = 1,6\text{ pF} & & \end{array} \quad \begin{array}{l} g_{22b} = 12\ \mu\text{S} \\ b_{22b} = 1,1\text{ mS} \\ C_{22b} = 1,75\text{ pF} \end{array}$$

Total perm. power dissipation versus temperature

$$P_{\text{tot}} = f(T_{\text{amb}})$$

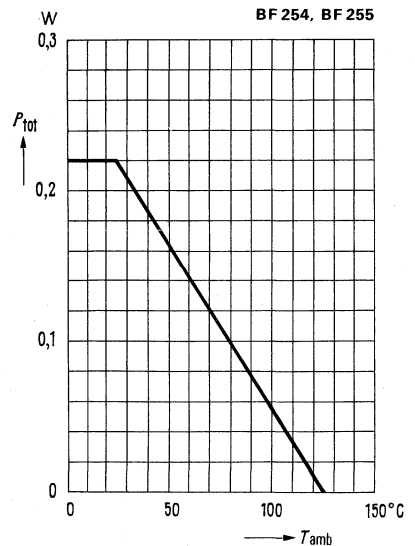

BF 256 A, B, and C are N-channel junction field-effect transistors in plastic package similar to TO 92 (10 A 3 DIN 41868). They are particularly suitable for RF applications.

Type	Ordering code
BF 256 A	Q68000-A5168
BF 256 B	Q62702-F413
BF 256 C	Q68000-A5169
BF 256	Q62702-F733

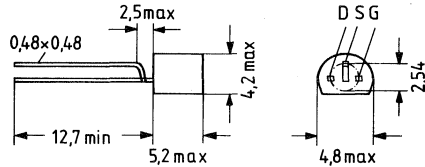

Approx. weight 0.25 g Dimensions in mm

Maximum ratings

Drain-source voltage	$\pm V_{DS}$	30	V
Drain-gate voltage ($I_S = 0$)	$+V_{DG0}$	30	V
Gate-source voltage ($I_D = 0$)	$-V_{GS0}$	30	V
Gate current	I_G	10	mA
Junction temperature	T_j	150	$^{\circ}\text{C}$
Storage temperature range	T_{stg}	-65 to 150	$^{\circ}\text{C}$
Total power dissipation ($T_{amb} \leq 75^{\circ}\text{C}$) ¹⁾	P_{tot}	300	mW

Thermal resistance

Junction to ambient air	R_{thJA}	≤ 250	$\text{K/W}^1)$
-------------------------	------------	------------	-----------------

1) If the transistors with max 3 mm lead length are fixed on PCBs with a 10 mm x 10 mm large copper area for the drain terminal, $R_{thJA} = 2 \text{ K/W}$, $P_{tot} = \text{max. } 300 \text{ mW}$ then applies up to $T_{amb} = 90^{\circ}\text{C}$.

Static characteristics ($T_{amb} = 25^{\circ}\text{C}$)

Gate cutoff current ($-V_{GS} = 20\text{ V}, V_{DS} = 0$)	$-I_{GSS}$	≤ 5	nA
Drain-source short-circuit current ($V_{DS} = 15\text{ V}, V_{GS} = 0$)	BF 256 A: I_{DSS} BF 256 B: I_{DSS} BF 256 C: I_{DSS}	3 to 7 6 to 13 11 to 18	mA mA ²⁾ mA
Gate-source voltage ($V_{DS} = 15\text{ V}, I_D = 200\text{ }\mu\text{A}$)	$-V_{GS}$	0.5 to 7.5	V ²⁾
Gate-source breakdown voltage ($-I_G = 1\text{ }\mu\text{A}, V_{DS} = 0$)	$-V_{(BR)GSS}$	≥ 30	V

Dynamic characteristics ($T_{amb} = 25^{\circ}\text{C}$)

Small-signal short-circuit forward transfer admittance ($V_{DS} = 15\text{ V}, V_{GS} = 0, f = 1\text{ kHz}$)	$ y_{21s} $	5 (≥ 4.5)	mS
Reverse transfer capacitance ($V_{DS} = 20\text{ V}, -V_{GS} = 1\text{ V}, f = 1\text{ MHz}$)	C_{12s}	0.7	pF
Output capacitance ($V_{DS} = 20\text{ V}, V_{GS} = 0, f = 1\text{ MHz}$)	C_{22s}	1.2	pF
Cutoff frequency of small-signal short circuit forward transfer admittance ¹⁾ ($V_{DS} = 15\text{ V}, V_{GS} = 0$)	f_{y21s}	1	GHz
Power gain ($V_{DS} = 15\text{ V}, R_S = 47\text{ }\Omega, f = 800\text{ MHz}$)	G_p	11	dB
Noise figure ($V_{DS} = 10\text{ V}, R_S = 47\text{ }\Omega, f = 800\text{ MHz}$)	NF	7.5	dB

1) Frequency for a decrease in the small-signal short-circuit forward transfer admittance to 70% of the value at 1 kHz.

2) BF 256 B 1: $I_{DSS} = 6$ to 8 mA , $-V_{GS} = 1.4$ to 2.6 V

BF 256 A
BF 256 B
BF 256 C

Total perm. power dissipation versus temperature

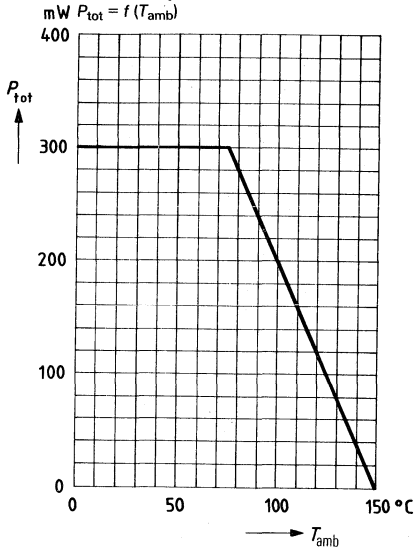

Reverse current versus temperature

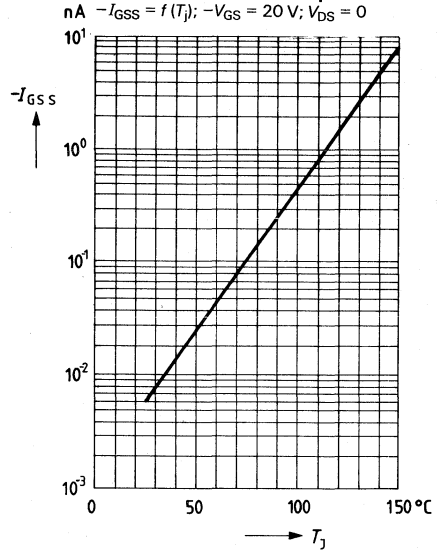

Dynamic drain-source resistance

$r_{\text{DS}} = f(-V_{\text{GS}}); V_{\text{DS}} = 0;$
 $f = 1 \text{ kHz}; T_{\text{amb}} = 25^{\circ}\text{C}$

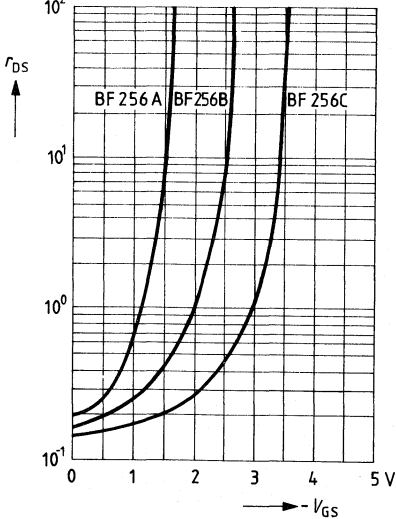

Small-signal short-circuit forward transfer admittance

$|y_{21s}| = f(I_{\text{D}})$
 $V_{\text{DS}} = 15 \text{ V}; f = 1 \text{ kHz}; T_{\text{amb}} = 25^{\circ}\text{C}$

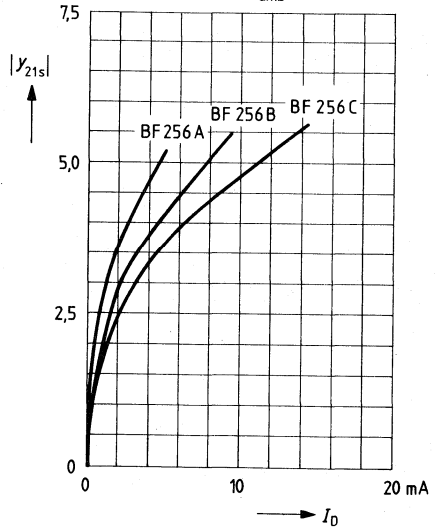

for large-signal VHF stages

BF 324 is an epitaxial PNP silicon planar transistor in TO 92 plastic package (10 A 3 DIN 41868). It is particularly outstanding for a low reverse transfer capacitance and is preferably used in common base configurations, e.g. in VHF tuner input stages.

Type	Ordering code
BF 324	Q62702-F311

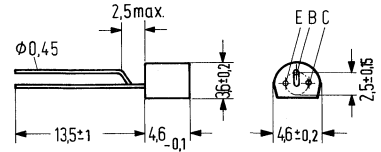

Approx. weight 0.25 g Dimensions in mm

Maximum ratings

Collector-emitter voltage	$-V_{CEO}$	30	V
Collector-base voltage	$-V_{CBO}$	30	V
Emitter-base voltage	$-V_{EBO}$	4	V
Collector current	$-I_C$	25	mA
Base current	$-I_B$	5	mA
Junction temperature	T_j	150	°C
Storage temperature range	T_{stg}	-55 to +150	°C
Total power dissipation	P_{tot}	250	mW

Thermal resistance

Junction to ambient air	R_{thJA}	≤420	K/W
-------------------------	------------	------	-----

Static characteristics ($T_{amb} = 25^{\circ}\text{C}$)

Collector cutoff current ($-V_{CB} = 30\text{ V}; I_E = 0$)	$-I_{CBO}$	< 50	nA
Collector-emitter breakdown voltage ($-I_C = 10\text{ mA}; I_B = 0$)	$-V_{(BR)CEO}$	> 30	V
Emitter-base breakdown voltage ($-I_E = 10\text{ }\mu\text{A}; I_C = 0$)	$-V_{(BR)EBO}$	> 4	V
DC current gain ($-V_{CE} = 10\text{ V}; -I_C = 1\text{ mA}$)	h_{FE}	45	-
($-V_{CE} = 10\text{ V}; -I_C = 4\text{ mA}$)	h_{FE}	50 (25 to 160)	-
Base-emitter voltage ($-V_{CE} = 10\text{ V}; -I_C = 4\text{ mA}$)	$-V_{BE}$	0.76	V

Dynamic characteristics ($T_{amb} = 25^{\circ}\text{C}$)

Transition frequency ($f = 100\text{ MHz}$) ($-I_C = 1\text{ mA}; -V_{CE} = 10\text{ V}$)	f_T	350	MHz
($-I_C = 4\text{ mA}; -V_{CE} = 10\text{ V}$)	f_T	450	MHz
($-I_C = 8\text{ mA}; -V_{CE} = 10\text{ V}$)	f_T	440	MHz
Reverse transfer capacitance ($-V_{CB} = 10\text{ V}; -V_{BE} = 0; f = 1\text{ MHz}$)	C_{12b}	0.1	pF
Noise figure ($-I_C = 2\text{ mA}; -V_{CE} = 10\text{ V};$ $f = 100\text{ MHz}; R_g = 60\text{ }\Omega$)	NF	3	dB

Total perm. power dissipation versus temperature
 $P_{tot} = f(T_{amb})$

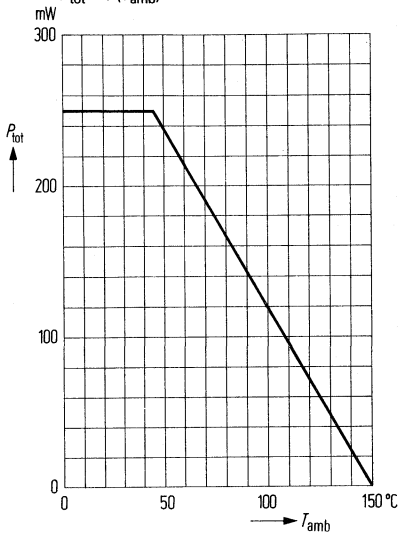

DC current gain $h_{FE} = f(I_C)$
 $-V_{CE} = 10\text{ V}$

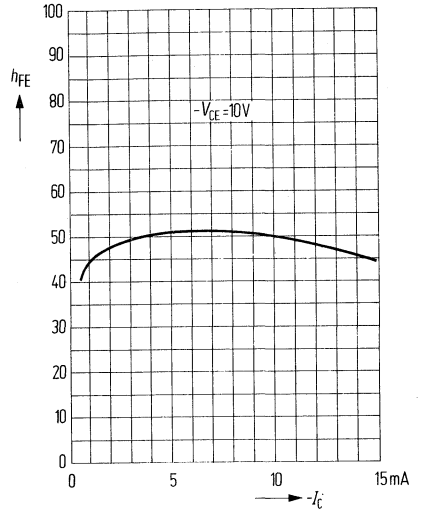

Output characteristics $I_C = f(V_{CE})$
 $I_B = \text{parameter}$

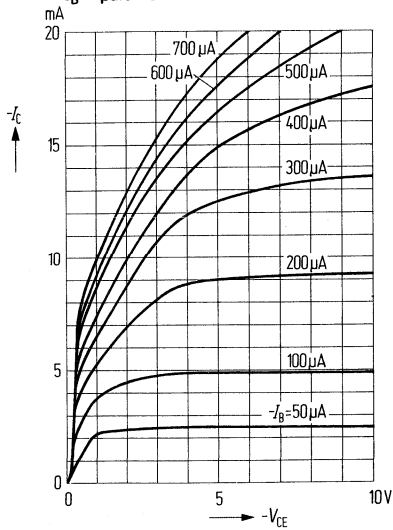

Input characteristic $I_C = f(V_{BE})$
 $-V_{CE} = 10\text{ V}$

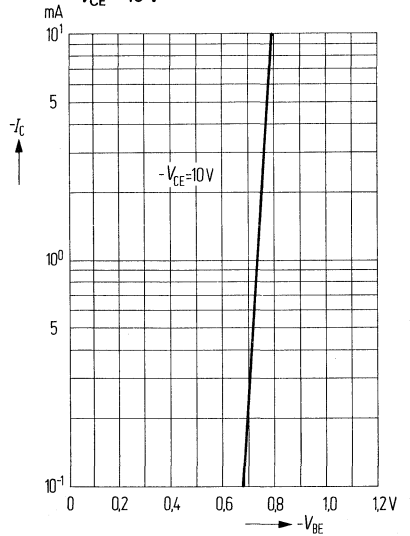

Transition frequency $f_T = f(I_C)$
 $V_{CE} = \text{parameter}, f = 100 \text{ MHz}$

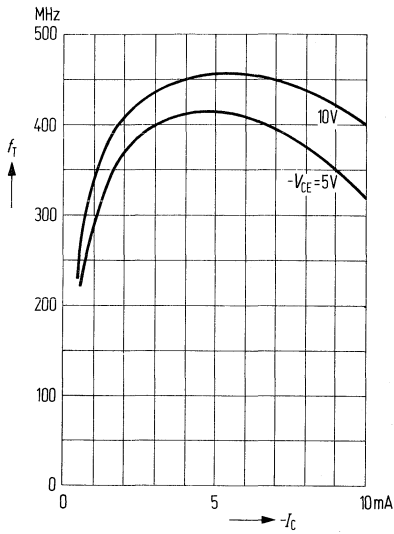

Input admittance Y_{11b}
 (common base configuration)
 $f = 100 \text{ MHz}; -V_{CE} = 10 \text{ V}$

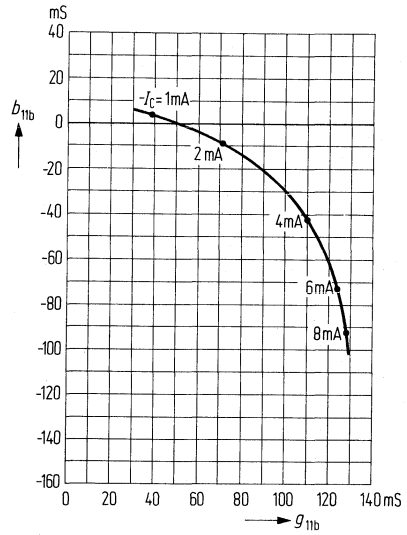

Output admittance Y_{22b}
 (common base configuration)
 $f = 100 \text{ MHz}; -V_{CE} = 10 \text{ V}$

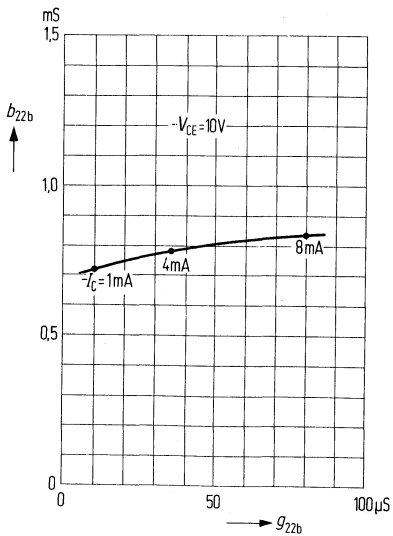

Short-circuit forward transfer admittance

$Y_{21b} = f(I_C)$
 (common base configuration)
 $-V_{CE} = 10 \text{ V}$

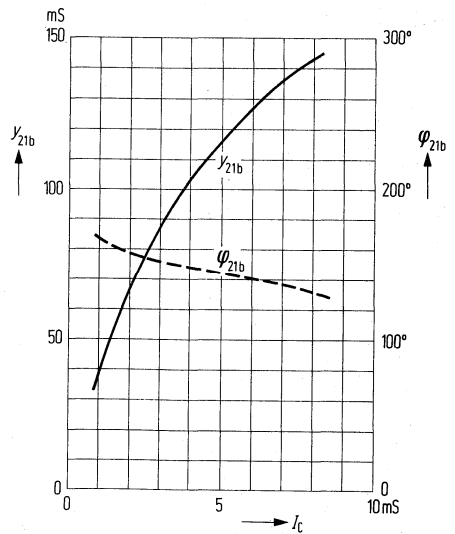

for UHF TV tuners

BF 362 and BF 363 are NPN silicon planar RF transistors in a plastic package similar to TO 119 (50 B3 DIN 41867). BF 362 is particularly suitable for gain-controlled input stages, and BF 363 for self-oscillating mixer stages in TV UHF tuners.

Type	Ordering code
BF 362	Q62702-F395
BF 363	Q62702-F396

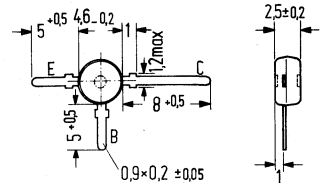

Approx. weight 0.25 g Dimensions in mm

Maximum ratings

Collector-emitter voltage	V_{CE0}	20	V
Collector-base voltage	V_{CBO}	20	V
Emitter-base voltage	V_{EBO}	3	V
Collector current	I_C	20	mA
Junction temperature	T_j	125	°C
Storage temperature range	T_{stg}	-55 to +125	°C
Total power dissipation ($T_{amb} \leq 55^\circ\text{C}$)	P_{tot}	120	mW

	BF 362, BF 363	
V_{CE0}	20	V
V_{CBO}	20	V
V_{EBO}	3	V
I_C	20	mA
T_j	125	°C
T_{stg}	-55 to +125	°C
P_{tot}	120	mW

Thermal resistance

Junction to ambient air	R_{thJA}	≤ 580	K/W
-------------------------	------------	------------	-----

Static characteristics ($T_{amb} = 25^\circ\text{C}$)

Base current ($I_E = 3 \text{ mA}; V_{CB} = 10 \text{ V}$)	I_B	< 150	μA
Base current ($I_E = 12 \text{ mA}; V_{CB} = 7 \text{ V}$)	I_B	< 1	mA
Base-emitter forward voltage ($I_C = 2 \text{ mA}; V_{CE} = 10 \text{ V}$)	V_{BE}	750	mV

Dynamic characteristics ($T_{amb} = 25^\circ\text{C}$)

		BF 362	BF 363	
Transition frequency ($I_C = 3\text{ mA}$; $V_{CE} = 10\text{ V}$; $f = 100\text{ MHz}$)	f_T	800	600–820	MHz
Power gain ($I_C = 3\text{ mA}$; $V_{CB} = 10\text{ V}$; $f = 900\text{ MHz}$; $R_g = 50\ \Omega$; $R_L = 500\ \Omega$)	G_p	> 11	> 11	dB
Noise figure ($I_C = 3\text{ mA}$; $V_{CB} = 10\text{ V}$) at $f = 500\text{ MHz}$; $Y_g = 16.7\text{ mS}$	NF	4	4	dB
at $f = 800\text{ MHz}$; $Y_g = 16.7\text{ mS}$	NF	4.5	5	dB
Short-circuit reverse transfer capacitance ($I_C = 1\text{ mA}$; $V_{CE} = 10\text{ V}$; $f = 1\text{ MHz}$)	$-C_{12e}$	0.33	0.33	pF
Small-signal short-circuit reverse transfer admittance ($I_C = 3\text{ mA}$; $V_{CB} = 10\text{ V}$; $f = 900\text{ MHz}$)	$ y_{12b} $	0.95	0.95	mS

Low-Noise N-channel Junction Field-Effect Transistor for RF Applications

BF 410 A
BF 410 B
BF 410 C
BF 410 D

BF 410 A, B, C, and D are asymmetric epitaxial planar N-channel junction field-effect transistors in plastic package similar to TO 92 (10 A 3 DIN 41868). They are designed for use up to the VHF range.

Type	Ordering code
BF 410	Q68000-A5440
BF 410 A	Q68000-A5172
BF 410 B	Q68000-A5173
BF 410 C	Q68000-A5174
BF 410 D	Q68000-A5175

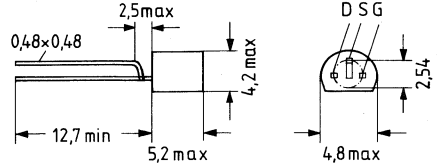

Approx. weight 0.25 g Dimensions in mm

Maximum ratings

Drain-source voltage
Drain-gate voltage ($I_s = 0$)
Drain current
Gate current
Junction temperature
Storage temperature range
Total power dissipation ($T_{amb} \leq 75^\circ\text{C}$)

	BF 410 A, BF 410 B BF 410 C, BF 410 D	
V_{DS}	20	V
V_{DG}	20	V
I_D	30	mA
$\pm I_G$	10	mA
T_j	150	$^\circ\text{C}$
T_{stg}	-65 to 150	$^\circ\text{C}$
P_{tot}	300	mW

Thermal resistance

Junction to ambient air

R_{thJA}	≤ 250	K/W
------------	------------	-----

BF 410 A
BF 410 B
BF 410 C
BF 410 D

Static characteristics ($T_{amb} = 25^{\circ}\text{C}$)		BF 410 A	BF 410 B	BF 410 C	BF 410 D	
Drain-source short-circuit current						
$(V_{DS} = 5\text{ V}, V_{GS} = 0)$	I_{DSS}	0.7 to 3	–	–	–	mA
$(V_{DS} = 10\text{ V}, V_{GS} = 0)$	I_{DSS}	–	2.5 to 7	6 to 12	10 to 18	mA
Gate-source pinch-off voltage						
$(V_{DS} = 5\text{ V}, I_D = 10\ \mu\text{A})$	$-V_P$	0.7	–	–	–	V
$(V_{DS} = 10\text{ V}, I_D = 10\ \mu\text{A})$	$-V_P$	–	1.5	2.2	3.2	V

Dynamic characteristics ($T_{amb} = 25^{\circ}\text{C}$)

Small-signal short-circuit forward transfer admittance						
$(f = 1\text{ kHz})$						
$(V_{DS} = 5\text{ V}, V_{GS} = 0)$	$ y_{21s} $	≥ 2.5	–	–	–	mS
$(V_{DS} = 10\text{ V}, V_{GS} = 0)$	$ y_{21s} $	–	≥ 4	≥ 7	≥ 8	mS
Output admittance ($f = 1\text{ kHz}$)						
$(V_{DS} = 5\text{ V}, V_{GS} = 0)$	g_{22s}	≤ 60	–	–	–	μS
$(V_{DS} = 10\text{ V}, V_{GS} = 0)$	g_{22s}	–	≤ 60	≤ 100	≤ 120	μS
Input capacitance ($f = 1\text{ MHz}$)						
$(V_{DS} = 5\text{ V}, V_{GS} = 0)$	C_{11s}	≤ 5	–	–	–	pF
$(V_{DS} = 10\text{ V}, V_{GS} = 0)$	C_{11s}	–	≤ 5	≤ 5	≤ 5	pF
Output capacitance ($f = 1\text{ MHz}$)						
$(V_{DS} = 5\text{ V}, V_{GS} = 0)$	C_{22s}	≤ 3	–	–	–	pF
$(V_{DS} = 10\text{ V}, V_{GS} = 0)$	C_{22s}	–	≤ 3	≤ 3	≤ 3	pF
Reverse transfer capacitance at $f = 1\text{ MHz}$						
$(V_{DS} = 5\text{ V}, V_{GS} = 0)$	C_{12s}	≤ 0.4	–	–	–	pF
$(V_{DS} = 10\text{ V}, V_{GS} = 0)$	C_{12s}	–	≤ 0.4	≤ 0.4	≤ 0.4	pF
Noise figure ($f = 100\text{ MHz}$, $R_g = R_{g\text{opt}} = 1\text{--}14\text{ mS}$)						
$(V_{DS} = 5\text{ V}, V_{GS} = 0)$	NF	1.5	–	–	–	dB
$(V_{DS} = 10\text{ V}, V_{GS} = 0)$	NF	–	1.5	1.5	1.5	dB

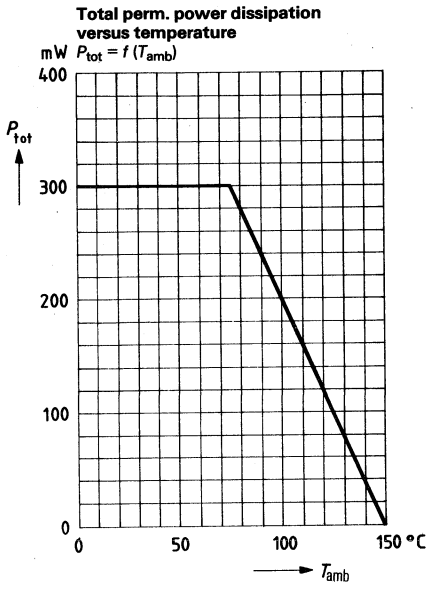

BF 414 is an epitaxial PNP silicon planar transistor in TO 92 plastic package (10 A 3 DIN 41868).

The transistor is particularly suitable for use in low-noise, large-signal VHF input stages in common base configuration.

Type	Ordering code
BF 414	Q62702-F517

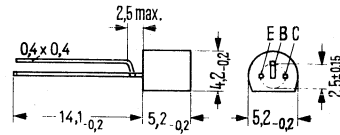

Mounting instruction: Fixing hole dia 0.6
Approx. weight 0.25 g Dimensions in mm

Maximum ratings

Collector-emitter voltage	$-V_{CEO}$	30	V
Collector-base voltage	$-V_{CBO}$	40	V
Emitter-base voltage	$-V_{EBO}$	4	V
Collector current	$-I_C$	25	mA
Base current	$-I_B$	3	mA
Junction temperature	T_j	150	°C
Storage temperature range	T_{stg}	-55 to +150	°C
Total power dissipation ($T_{amb} = 45^\circ\text{C}$)	P_{tot}	300	mW

Thermal resistance

Junction to ambient air	R_{thJA}	< 350	K/W
-------------------------	------------	-------	-----

Static characteristics ($T_{amb} = 25^\circ\text{C}$)

Collector cutoff current ($-V_{CB} = 20\text{ V}$)	$-I_{CBO}$	60	nA
Collector-emitter breakdown voltage ($-I_C = 2\text{ mA}$)	$-V_{(BR)CEO}$	> 30	V
Collector-base breakdown voltage ($-I_C = 10\ \mu\text{A}$)	$-V_{(BR)CBO}$	> 40	V
Emitter-base breakdown voltage ($-I_E = 10\ \mu\text{A}$)	$-V_{(BR)EBO}$	> 4	V
DC current gain ($-V_{CE} = 10\text{ V}; -I_C = 1\text{ mA}$)	h_{FE}	80	-

Dynamic characteristics ($T_{\text{amb}} = 25^{\circ}\text{C}$)

Transition frequency

($-I_C = 1 \text{ mA}$; $-V_{CE} = 10 \text{ V}$; $f = 100 \text{ MHz}$)($-I_C = 5 \text{ mA}$; $-V_{CE} = 10 \text{ V}$; $f = 100 \text{ MHz}$)

Reverse transfer capacitance

($-V_{CE} = 10 \text{ V}$; $f = 1 \text{ MHz}$)

Noise figure

($-I_C = 5 \text{ mA}$; $-V_{CE} = 10 \text{ V}$; $f = 100 \text{ MHz}$) $R_g = 60 \Omega$)

f_T	400	MHz
f_T	560	MHz
C_{12b}	0.1	pF
NF	3	dB

BF 420 and BF 422 are epitaxial NPN silicon planar transistors in TO 92 plastic package (10 A 3 DIN 41 868). With the complementary types BF 421 and BF 423, these transistors are particularly suitable for use in video B output stages of TV receivers.

Type	Ordering code
BF 420	Q62702-F531
BF 422	Q62702-F495

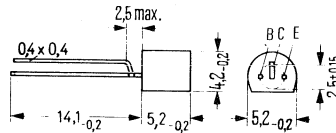

Approx. weight 0.25 g

Dimensions in mm

Maximum ratings ($T_{amb} = 25^{\circ}\text{C}$)

		BF 420	BF 422	
Collector-base voltage	V_{CBO}	300	250	V
Collector-emitter voltage	V_{CEO}	—	250	V
Collector-emitter voltage	V_{CER}	300	—	V
Emitter-base voltage	V_{EBO}	5	5	V
Collector current	I_C	25	25	mA
Collector peak current	I_{CM}	100	100	mA
Junction temperature	T_j	150	150	$^{\circ}\text{C}$
Storage temperature range	T_{stg}	-65 to +150	-65 to +150	$^{\circ}\text{C}$
Total power dissipation ¹⁾	P_{tot}	830	830	mW

Thermal resistance

Junction to ambient air ¹⁾	R_{thJA}	≤ 150	≤ 150	K/W
---------------------------------------	------------	------------	------------	-----

1) For fixing the transistors with max. 3 mm long leads on PCBs with a 10 mm² large copper area for the collector terminal.

Static characteristics ($T_{amb} = 25^{\circ}\text{C}$)

	BF 420	BF 422	
Collector-base breakdown voltage	$V_{(BR)CBO} > 300$	> 250	V
Collector-emitter breakdown voltage	$V_{(BR)CEO} -$	> 250	V
Collector-emitter breakdown voltage ($R_{BE} = 2.7 \text{ k}\Omega$)	$V_{(BR)CER} 300$	-	V
Emitter-base breakdown voltage	$V_{(BR)EBO} > 5$	> 5	V
Collector cutoff current ($V_{CB} = 200 \text{ V}$)	$I_{CBO} \leq 10$	≤ 10	nA
Collector cutoff current ($R_{BE} = 10 \text{ k}\Omega, V_{CE} = 200 \text{ V}, T_j = 150^{\circ}\text{C}$)	$I_{CER} \leq 10$	≤ 10	μA
Emitter cutoff current ($V_{EB} = 5 \text{ V}$)	$I_{EBO} \leq 10$	≤ 10	μA
Collector-emitter saturation voltage ($I_C = 25 \text{ mA}, T_j = 150^{\circ}\text{C}$)	$V_{CEsat \text{ RF}} 20$	20	V
DC current gain ($I_C = 25 \text{ mA}; V_{CE} = 20 \text{ V}$)	$h_{FE} \geq 40$	≥ 50	-

Dynamic characteristics ($T_{amb} = 25^{\circ}\text{C}$)

Transition frequency ($V_{CE} = 10 \text{ V}; I_C = 10 \text{ mA}$)	$f_T \geq 60$	≥ 60	MHz
Reverse transfer capacitance ($V_{CB} = 30 \text{ V}$)	$-C_{12e} \leq 1.6$	≤ 1.6	pF
Feedback time constant ($V_{CB} = 20 \text{ V}; -I_E = 10 \text{ mA}; f = 10.7 \text{ MHz}$)	$r_{bb'} \cdot C_{b'c} \leq 70$	≤ 70	ps

Total perm. power dissipation versus temperature

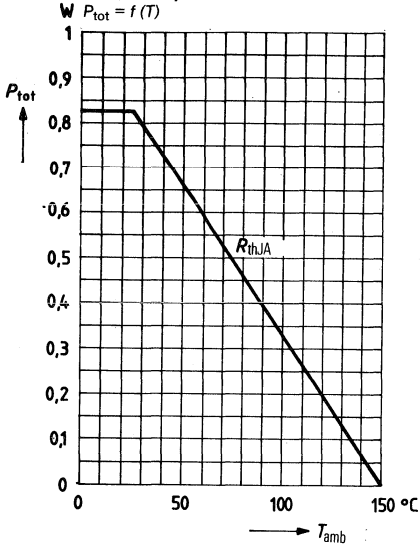

DC current gain $h_{FE} = f(I_C)$

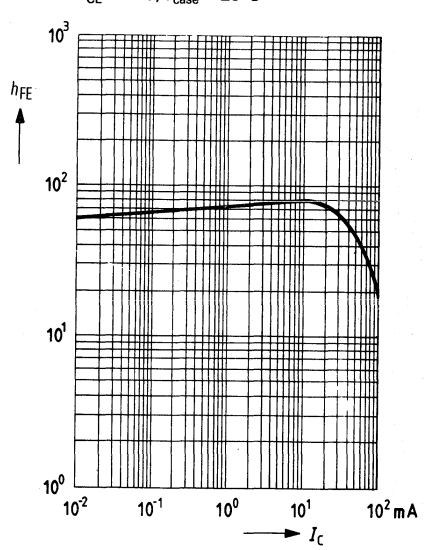

Collector current $I_C = f(V_{BE})$

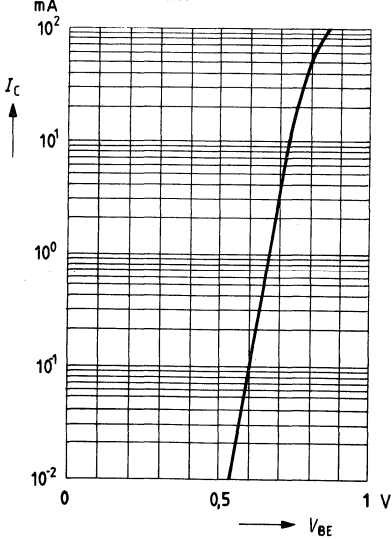

Transition frequency $f_T = f(I_C)$

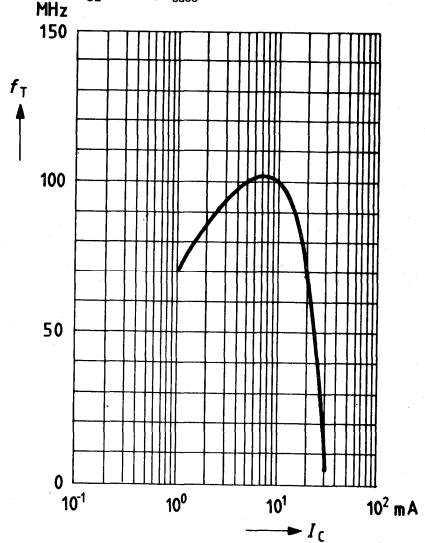

BF 421 and BF 423 are epitaxial PNP silicon planar transistors in TO 92 plastic package (10 A 3 DIN 41868). With the complementary types BF 420 and BF 422, these transistors are particularly suitable for use in video B output stages of TV receivers.

Type	Ordering code
BF 421	Q62702-F532
BF 423	Q62702-F496

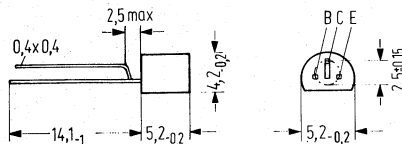

Mounting instruction:
Fixing hole dia 0.6
Approx. weight 0.25 g

Dimensions in mm

Maximum ratings ($T_{amb} = 25^{\circ}\text{C}$)

	BF 421	BF 423	
Collector-base voltage	$-V_{CBO}$ 300	250	V
Collector-emitter voltage	$-V_{CEO}$ -	250	V
Collector-emitter voltage	$-V_{CER}$ 300	-	V
Emitter-base voltage	$-V_{EBO}$ 5	5	V
Collector current	$-I_C$ 25	25	mA
Collector peak current	$-I_{CM}$ 100	100	mA
Junction temperature	T_j 150	150	$^{\circ}\text{C}$
Storage temperature range	T_{stg} -65 to +150	-65 to +150	$^{\circ}\text{C}$
Total power dissipation ¹⁾	P_{tot} 830	830	mW

Thermal resistance

Junction to ambient air ¹⁾	R_{thJA}	≤ 150	≤ 150	K/W
---------------------------------------	------------	------------	------------	-----

1) For fixing the transistors with max. 3 mm long leads on PCBs with a 10 mm² large copper area for the collector terminal.

Static characteristics ($T_{amb} = 25^{\circ}\text{C}$)

	BF 421	BF 423	
Collector-base breakdown voltage	$-V_{(BR)CBO} > 300$	> 250	V
Collector-emitter breakdown voltage	$-V_{(BR)CEO} -$	> 250	V
Collector-emitter breakdown voltage ($R_{BE} = 2.7 \Omega$)	$-V_{(BR)CER} 300$	-	V
Emitter-base breakdown voltage	$-V_{(BR)EBO} > 5$	> 5	V
Collector cutoff current ($-V_{CB} = 200 \text{ V}$)	$-I_{CBO} \leq 10$	≤ 10	nA
Collector cutoff current ($R_{BE} = 10 \text{ k}\Omega$, $-V_{CE} = 200 \text{ V}$, $T_j = 150^{\circ}\text{C}$)	$-I_{CER} \leq 10$	≤ 10	μA
Emitter cutoff current ($-V_{EB} = 5 \text{ V}$)	$-I_{EBO} \leq 10$	≤ 10	μA
Collector-emitter saturation voltage ($-I_C = 25 \text{ mA}$, $T_j = 150^{\circ}\text{C}$)	$-V_{CEsat RF} 20$	20	V
DC current gain ($-I_C = 25 \text{ mA}$; $-V_{CE} = 20 \text{ V}$)	$h_{FE} \geq 40$	≥ 50	-

Dynamic characteristics ($T_{amb} = 25^{\circ}\text{C}$)

Transition frequency ($V_{CE} = 10 \text{ V}$; $I_C = 10 \text{ mA}$)	$f_T \geq 60$	≥ 60	MHz
Reverse transfer capacitance ($-V_{CB} = 30 \text{ V}$)	$-C_{12e} \leq 1.6$	≤ 1.6	pF
Feedback time constant ($-V_{CB} = 20 \text{ V}$; $I_E = 10 \text{ mA}$; $f = 10.7 \text{ MHz}$)	$r_{bb'} C_{b'c} \leq 70$	≤ 70	ps

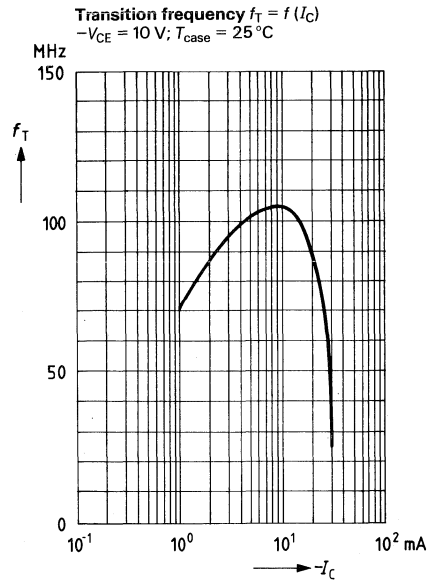
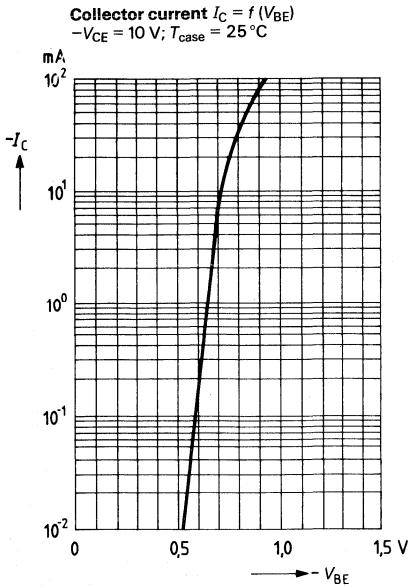
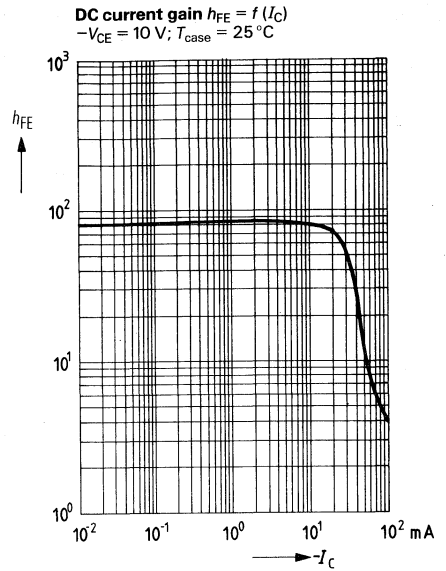
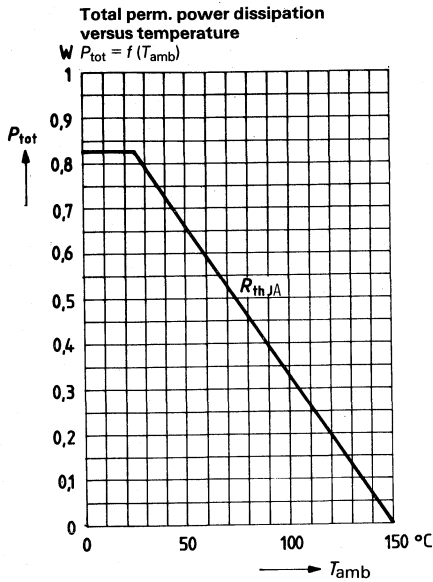

for broadcast applications

BF 450 and BF 451 are epitaxial PNP silicon planar transistors in TO 92 plastic package (10 A 3 DIN 41868). They are especially suitable for use in AM/FM IF amplifier stages, the BF 450 being designed for gain controlled stages and the BF 451 for uncontrolled stages.

Type	Ordering code
BF 450	Q62702-F312
BF 451	Q62702-F313

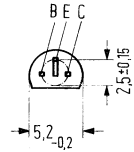
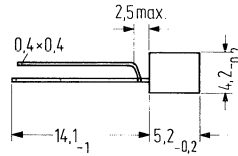

Approx. weight 0.25 g

Dimensions in mm

Maximum ratings

	BF 450	BF 451		
Collector-emitter voltage	-V _{CEO}	40	40	V
Collector-base voltage	-V _{CBO}	40	40	V
Emitter-base voltage	-V _{EBO}	4	4	V
Collector current	-I _C	25	25	mA
Base current	-I _B	5	5	mA
Junction temperature	T _j	150	150	°C
Storage temperature range	T _{stg}	-55 to +150		°C
Total power dissipation (T _{amb} = 45°C)	P _{tot}	250	250	mW

Thermal resistance

Junction to ambient air	R _{thJA}	≤420	≤420	K/W
-------------------------	-------------------	------	------	-----

Static characteristics ($T_{amb} = 25^{\circ}\text{C}$)		BF 450	BF 451	
Collector cutoff current ($-V_{CB} = 30\text{ V}$)	$-I_{CBO}$	< 50	< 50	nA
Collector-base breakdown voltage ($-I_C = 10\ \mu\text{A}$)	$-V_{(BR)CBO}$	> 40	> 40	V
Collector-emitter breakdown voltage ($-I_C = 2\text{ mA}$)	$-V_{(BR)CEO}$	> 40	> 40	V
Emitter-base breakdown voltage ($I_E = 10\ \mu\text{A}$)	$-V_{(BR)EBO}$	> 4	> 4	V
Base-emitter forward voltage ($-I_C = 1\text{ mA}$; $-V_{CE} = 10\text{ V}$)	$-V_{BE}$	0.72	0.73	V
DC current gain ($-I_C = 1\text{ mA}$; $-V_{CE} = 10\text{ V}$)	h_{FE}	> 60	> 30	-

Dynamic characteristics ($T_{amb} = 25^{\circ}\text{C}$)				
Transition frequency ($-I_C = 1\text{ mA}$; $-V_{CE} = 10\text{ V}$; $f = 100\text{ MHz}$)	f_T	375	325	MHz
Reverse transfer capacitance ($-I_C = 1\text{ mA}$; $-V_{CE} = 10\text{ V}$; $f = 1\text{ MHz}$)	$-C_{12e}$	0.32	0.32	pF
Noise figure ($-I_C = 1\text{ mA}$; $-V_{CE} = 10\text{ V}$; $f = 100\text{ kHz}$; $R_g = 300\ \Omega$)	NF	2	2	dB
($-I_C = 2\text{ mA}$; $-V_{CE} = 10\text{ V}$; $f = 100\text{ kHz}$; $R_g = 60\ \Omega$)	NF	3.4	3.4	dB

Four-pole characteristics ($-I_C = 1\text{ mA}$; $-V_{CE} = 10\text{ V}$)				
$f = 0.45\text{ to }10\text{ MHz}$	g_{11e}	0.5	0.8	mS
	C_{11e}	17	19	pF
	$ y_{21e} $	35	35	mS
	C_{22e}	1.4	1.4	pF
	g_{22e}	< 8	< 8	μS
$f = 450\text{ kHz}$	g_{22e}	< 10	< 10	μS

Total perm. power dissipation versus temperature

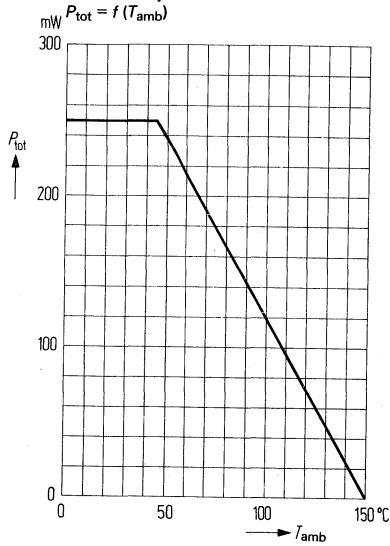

Input characteristic $I_C = f(V_{BE})$
 $-V_{CE} = 10\text{ V}$

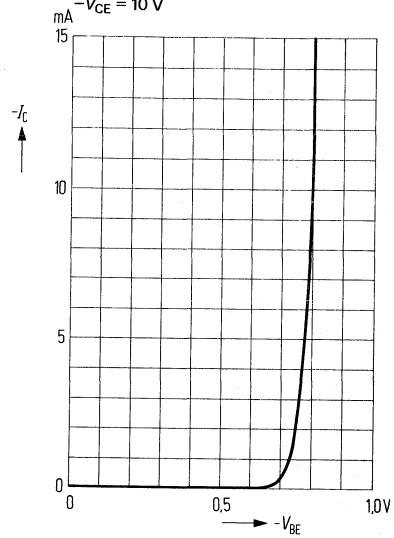

Output characteristics $I_C = f(V_{CE})$
 $I_B = \text{parameter}$

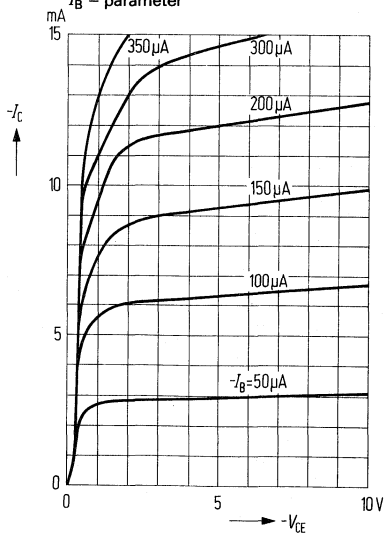

Collector current $I_C = f(I_B)$
 $V_{CE} = \text{parameter}$

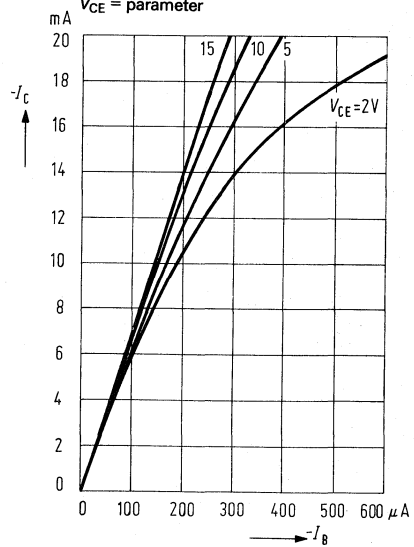

Transition frequency $f_T = f(I_C)$
 $V_{CE} = \text{parameter}; f = 100 \text{ MHz}$

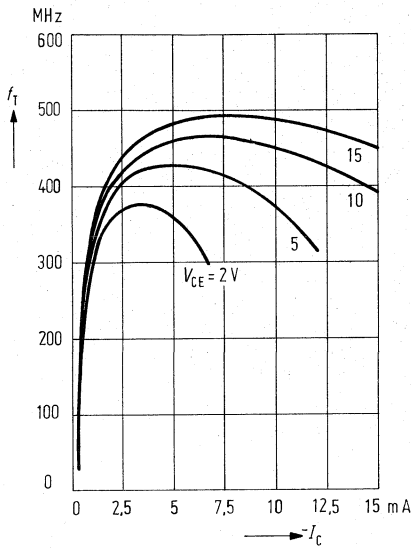

Output admittance $g_{22e} = f(I_C)$
 $V_{CE} = 10 \text{ V}; f = 500 \text{ kHz}$

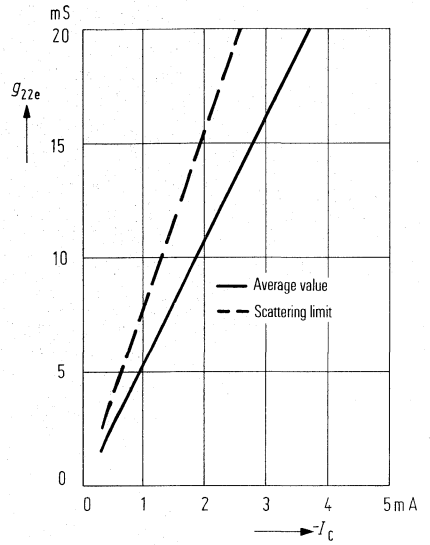

Reverse transfer capacitance
 $-C_{12e} = f(I_C); I_C = 1 \text{ mA}; f = 1 \text{ kHz}$

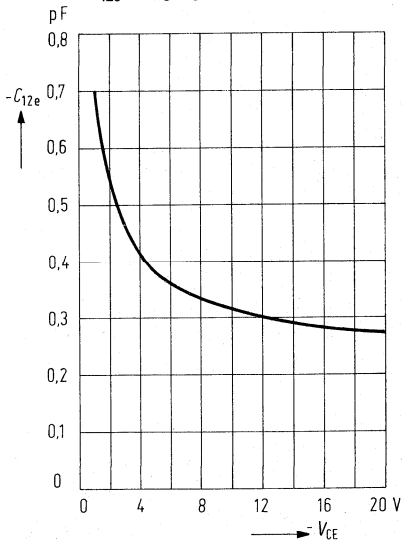

Small signal short circuit forward transfer admittance $|y_{21e}| = f(I_C)$
 $V_{CE} = \text{parameter}; f = 10.7 \text{ MHz}$

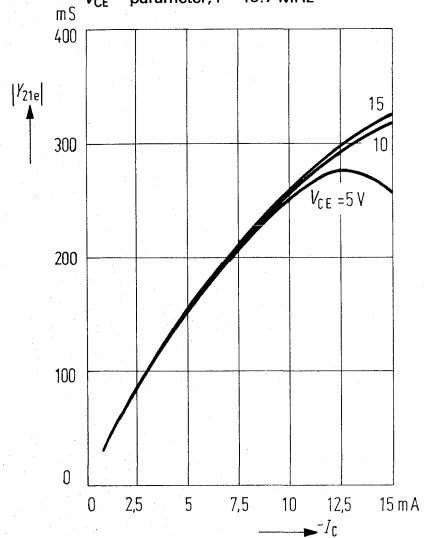

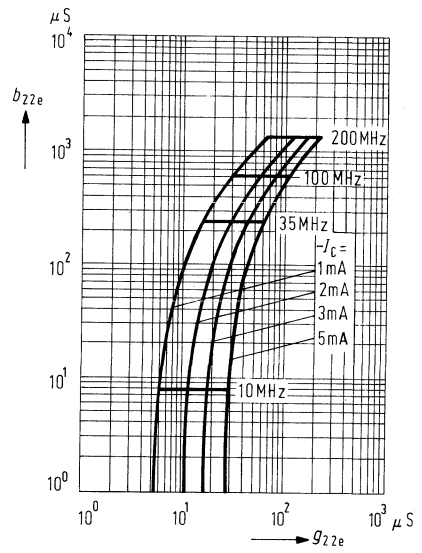
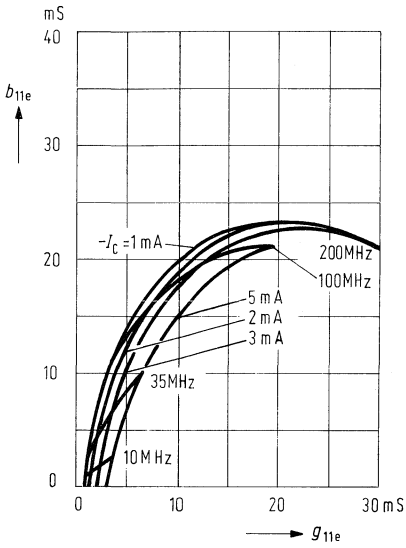

Small signal short circuit forward transfer admittance $|Y_{21e}|$

$-V_{CE} = 10$ V

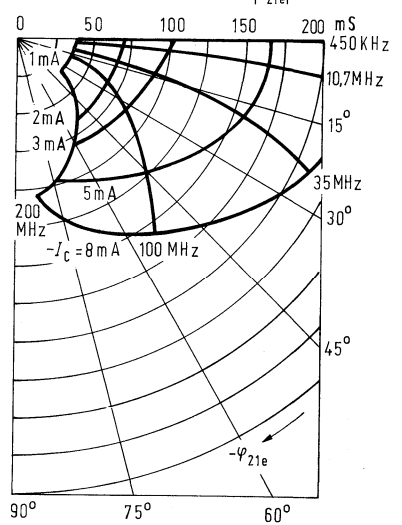

for video and AF output stages

BF 457, BF 458 and BF 459 are epitaxial NPN silicon planar transistors in TO 126 plastic package (12 A 3 DIN 41 869). The collector is conductively connected to the metallic mounting area of the transistor. The transistors are especially designed for use in video output stages of TV receivers, for AF output stages of high operating voltage, and as driver transistors in horizontal deflection circuits.

Type	Ordering code
BF 457	Q62702-F315
BF 458	Q62702-F316
BF 459	Q62702-F317
Mica washer	Q62902-B62
Spring washer	Q62902-B63
A 3 DIN 137	

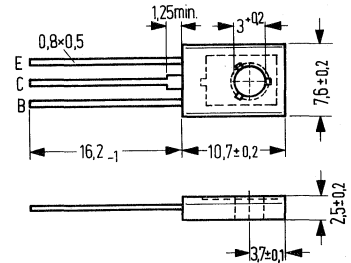

Approx. weight 0.5 g Dimensions in mm

Maximum ratings

	BF 457	BF 458	BF 459		
Collector-base voltage	V_{CB0}	160	270	300	V
Collector-emitter voltage	V_{CE0}	160	250	300	V
Emitter-base voltage	V_{EBO}	5	5	5	V
Collector current	I_C	100	100	100	mA
Base current	I_B	50	50	50	mA
Collector peak current	I_{CM}	300	300	300	mA
Junction temperature	T_j	150	150	150	°C
Storage temperature range	T_{stg}		-55 to +150		°C
Total power dissipation ($T_{amb} \leq 25^\circ\text{C}$)	P_{tot}	1.2	1.2	1.2	W
($T_{case} \leq 45^\circ\text{C}$)	P_{tot}	10	10	10	W

Thermal resistance

Junction to ambient air	$R_{thJA}^{1)}$	≤ 104	≤ 104	≤ 104	K/W
Junction to case	R_{thJC}	≤ 10	≤ 10	≤ 10	K/W

1) Starting torque for the M3 screw used for mounting = max. 0.8 Nm. Thermal resistance of a 50 μ mica washer, ungreased 8 K/W; greased 4 K/W. A washer or corrugated spring washer A 3 DIN 137 should be placed below the screw head.

Static characteristics ($T_{amb} = 25^{\circ}\text{C}$)		BF 457	BF 458	BF 459	
Collector-base breakdown voltage ($I_C = 100\ \mu\text{A}$)	$V_{(BR)CBO}$	> 160	> 250	> 300	V
Collector-emitter breakdown voltage ($I_C = 10\ \text{mA}$)	$V_{(BR)CEO}$	> 160	> 250	> 300	V
Emitter-base breakdown voltage ($I_E = 100\ \mu\text{A}$)	$V_{(BR)EBO}$	> 5	> 5	> 5	V
Collector cutoff current ($V_{CB} = 100\ \text{V}$)	I_{CBO}	< 50	–	–	nA
($V_{CB} = 200\ \text{V}$)	I_{CBO}	–	< 50	–	nA
($V_{CB} = 250\ \text{V}$)	I_{CBO}	–	–	< 50	nA
Emitter cutoff current ($V_{EB} = 3\ \text{V}$)	I_{EBO}	< 50	< 50	< 50	nA
Collector-emitter saturation voltage ($I_C = 30\ \text{mA}$; $I_B = 6\ \text{mA}$)	V_{CEsat}	< 1	< 1	< 1	V
DC current gain ($I_C = 30\ \text{mA}$; $V_{CE} = 10\ \text{V}$)	h_{FE}	> 25	> 25	> 25	–

Dynamic characteristics ($T_{amb} = 25^{\circ}\text{C}$)					
Transition frequency ($V_{CE} = 10\ \text{V}$; $I_C = 15\ \text{mA}$; $f = 20\ \text{MHz}$)	f_T	90	90	90	MHz
Reverse transfer capacitance ($V_{CE} = 30\ \text{V}$; $f = 1\ \text{MHz}$; $I_C = 1\ \text{mA}$)	$-C_{12e}$	4.2	4.2	4.2	pF
Output capacitance ($V_{CB} = 30\ \text{V}$; $f = 1\ \text{MHz}$; $I_E = 0$)	C_{22e}	5.5	5.5	5.5	pF

Total perm. power dissipation versus temperature
 $P_{tot} = f(T)$

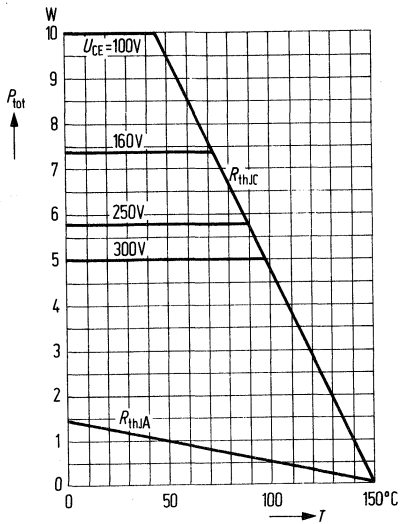

Permissible pulse load
 $r_{thJC} = f(t); v = \text{parameter}$

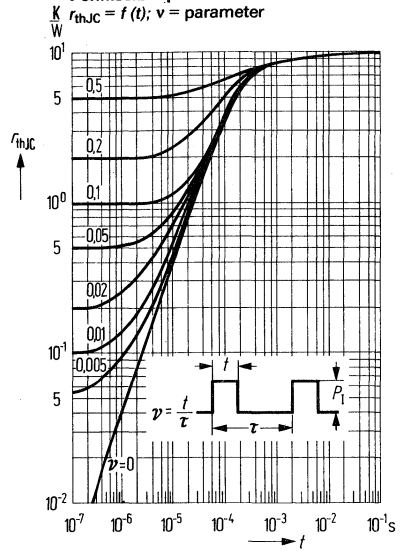

Permissible operating range
 $I_C = f(V_{CE}); (T_{case} = 45^{\circ}C); v = 0.01$

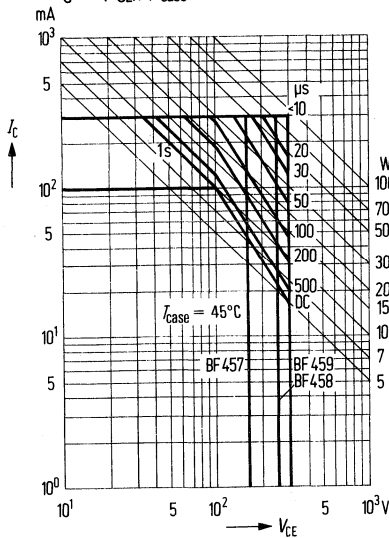

Permissible operating range
 $I_C = f(V_{CE}); (T_{case} = 45^{\circ}C); v = 0.1$

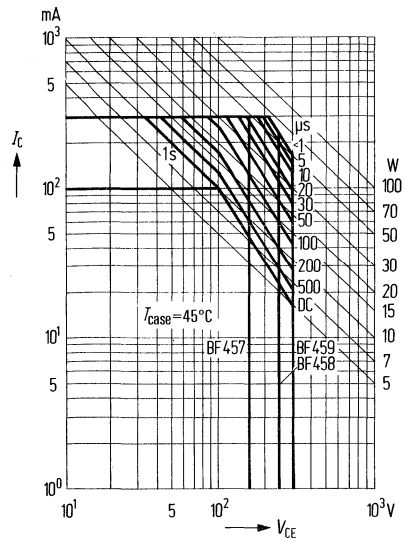

Collector current $I_C = f(V_{BE})$
 $V_{CE} = 10\text{ V}; T_{\text{case}} = \text{parameter}$

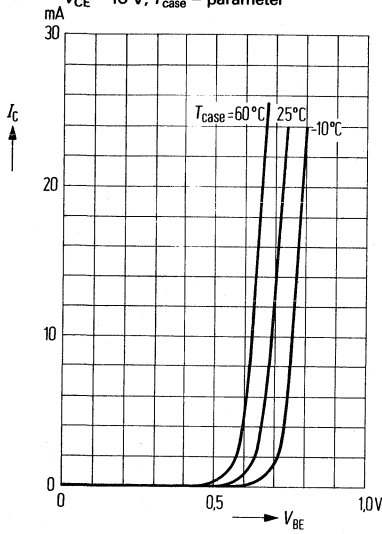

Output characteristics $I_C = f(V_{CE})$
 $I_B = \text{parameter}$

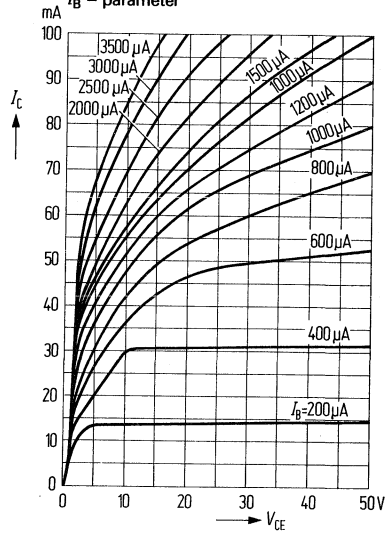

Base current $I_B = f(I_C)$
 $V_{CE} = 10\text{ V}; T_{\text{case}} = \text{parameter}$

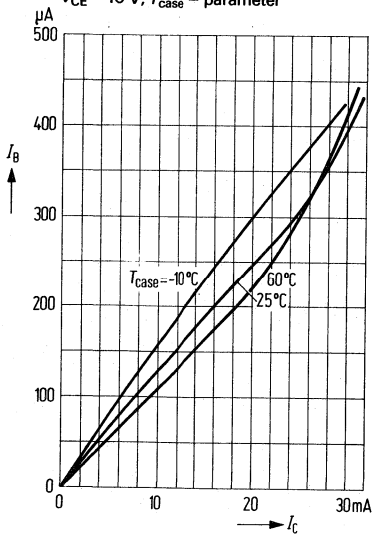

Transition frequency $f_T = f(I_C)$
 $V_{CE} = 10\text{ V}; f = 20\text{ MHz}$

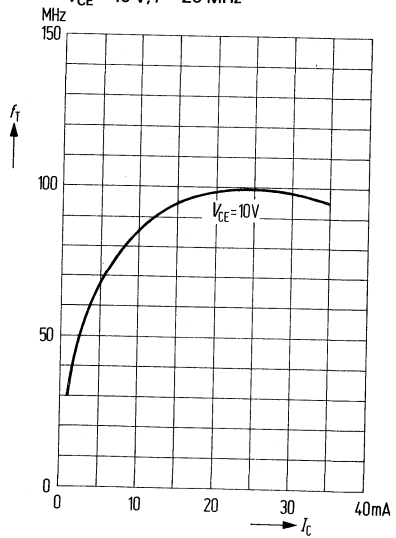

BF 469 and BF 471 are epitaxial NPN silicon planar transistors in TO 126 plastic package (12 A 3 DIN 41869, sheet 4). The collector is conductively connected to the metallic mounting area of the transistor. With the complementary types BF 470 and BF 472, these transistors are particularly suitable for use in video B output stages of TV receivers.

Type	Ordering code
BF 469	Q62702-F497
BF 471	Q62702-F507
Spring washer	Q62902-B63
A3 DIN 137	
Mica washer	Q62902-B62

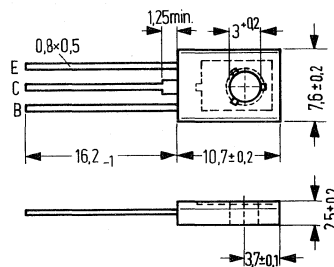

Approx. weight 0.5 g Dimensions in mm
 Transistor fixing with M 3 screw;
 starting torque max. 0.8 Nm;
 washer or spring washer should be used.

Maximum ratings

	BF 469	BF 471		
Collector-base voltage	V_{CB0}	250	300	V
Collector-emitter voltage	V_{CEO}	250	—	V
Collector-emitter voltage	V_{CER}	—	300	V
Emitter-base voltage	V_{EBO}	5	5	V
Collector current	I_C	30	30	mA
Collector peak current	I_{CM}	100	100	mA
Junction temperature	T_j	150	150	°C
Storage temperature range	T_{stg}	-65 to +150	-65 to +150	°C
Total power dissipation ($T_{case} \leq 110^\circ\text{C}$)	P_{tot}	2	2	W

Thermal resistance

Junction to ambient air ¹⁾	R_{thJA}	≤ 100	≤ 100	K/W
Junction to case	R_{thJC}	≤ 20	≤ 20	K/W

1) For fixing the transistors with max. 4 mm long leads on PCBs with a 10 mm² large copper area for the collector terminal.

Static characteristics ($T_{amb} = 25^{\circ}\text{C}$)

	BF 469	BF 471	
Collector-base breakdown voltage ($I_C = 10 \mu\text{A}$)	$V_{(BR)CBO} > 250$	> 300	V
Collector-emitter breakdown voltage ($I_C = 1 \mu\text{A}$)	$V_{(BR)CEO} > 250$	–	V
Collector-emitter breakdown voltage ($R_{BE} = 2.7 \text{ k}\Omega$)	$V_{(BR)CER} -$	> 300	V
Emitter-base breakdown voltage ($I_E = 10 \mu\text{A}$)	$V_{(BR)EBO} > 5$	> 5	V
Collector cutoff current ($V_{CE} = 200 \text{ V}$; $R_{BE} = 2.7 \text{ k}\Omega$; $T_{amb} = 150^{\circ}\text{C}$)	$I_{CER} \leq 10$	≤ 10	μA
Collector cutoff current ($V_{CB} = 200 \text{ V}$)	$I_{CBO} \leq 10$	≤ 10	nA
Emitter cutoff current ($V_{EB} = 5 \text{ V}$)	$I_{EBO} \leq 10$	≤ 10	μA
Collector-emitter saturation voltage ($I_C = 25 \text{ mA}$; $T_j = 150^{\circ}\text{C}$)	$V_{CEsat HF} 20$	–	V
($I_C = 25 \text{ mA}$; $T_{amb} = 150^{\circ}\text{C}$)	–	20	V
DC current gain ($I_C = 25 \text{ mA}$; $V_{CE} = 20 \text{ V}$)	$h_{FE} \geq 50$	≥ 40	–

Dynamic characteristics ($T_{amb} = 25^{\circ}\text{C}$)

Transition frequency ($V_{CE} = 10 \text{ V}$; $I_C = 10 \text{ mA}$);	$f_T \geq 60$	≥ 60	MHz
Reverse transfer capacitance ($V_{CB} = 30 \text{ V}$)	$-C_{12e} \leq 1.8$	≤ 1.8	pF
Feedback time constant ($V_{CB} = 20 \text{ V}$; $-I_E = 10 \text{ mA}$; $f = 10,7 \text{ MHz}$)	$r_{bb'} \cdot C_{b'c} \leq 90$	≤ 90	ps

Total perm. power dissipation versus temperature

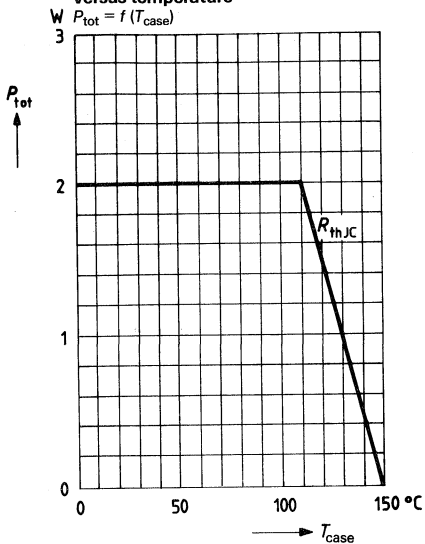

DC current gain $h_{FE} = f(I_C)$
 $V_{CE} = 10 \text{ V}; T_{\text{case}} = 25^\circ\text{C}$

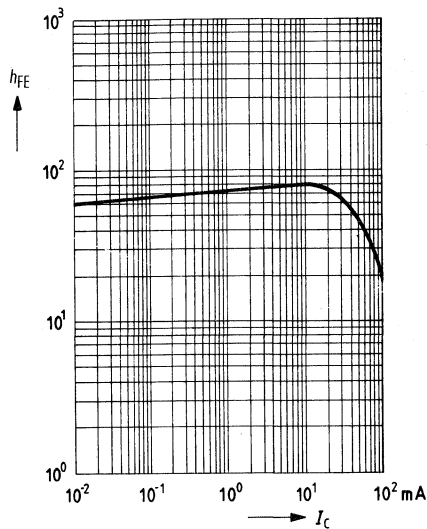

Collector current $I_C = f(V_{BE})$
 $V_{CE} = 10 \text{ V}; T_{\text{case}} = 25^\circ\text{C}$

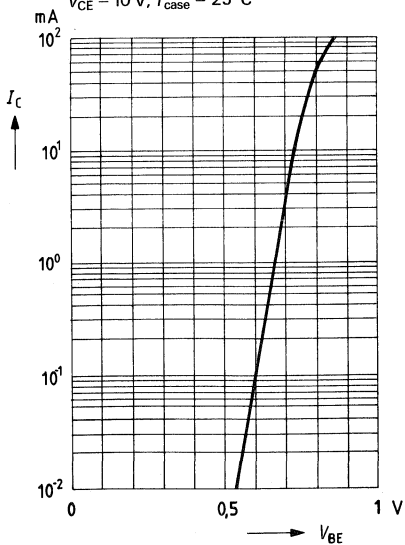

Transition frequency $f_T = f(I_C)$
 $V_{CE} = 10 \text{ V}; T_{\text{case}} = 25^\circ\text{C}$

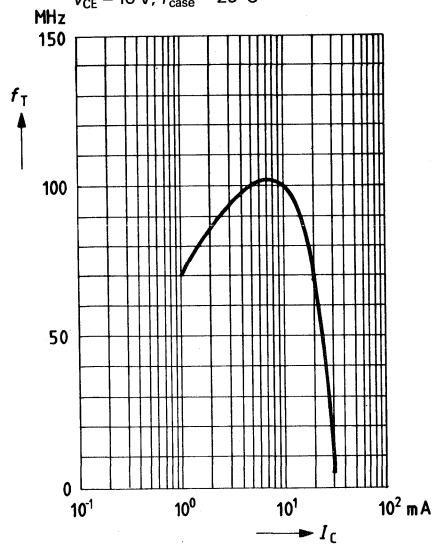

BF 470 and BF 472 are epitaxial PNP silicon planar transistors in TO 126 plastic package (12 A 3 DIN 41869, sheet 4). The collector is conductively connected to the metallic mounting area of the transistor. With the complementary types BF 469 and BF 471 these transistors are particularly suitable for use in video B output stages of TV receivers.

Type	Ordering code
BF 470	Q62702-F498
BF 472	Q62702-F506
Spring washer A 3 DIN 137	Q62902-B63
Mica washer	Q62902-B62

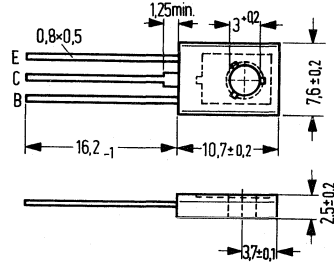

Approx. weight 0.5 g Dimensions in mm

Maximum ratings

	BF 470	BF 472		
Collector-base voltage	-V _{CB0}	250	300	V
Collector-emitter voltage	-V _{CE0}	250	-	V
Collector-emitter voltage	-V _{CER}	-	300	V
Emitter-base voltage	-V _{EBO}	5	5	V
Collector current	-I _C	30	30	mA
Collector peak current	-I _{CM}	100	100	mA
Junction temperature	T _j	150	150	°C
Storage temperature range	T _{stg}	-65 to +150	-65 to +150	°C
Total power dissipation (T _{case} ≤ 110 °C)	P _{tot}	2	2	W

Thermal resistance

Junction to ambient air ¹⁾	R _{thJA}	≤ 100	≤ 100	K/W
Junction to case	R _{thJC}	≤ 20	≤ 20	K/W

1) For fixing the transistors with max. 4 mm long leads on PCBs with a 10 mm² large copper area for the collector terminal.

Static characteristics ($T_{amb} = 25^{\circ}\text{C}$)

	BF 470	BF 472	
Collector-base breakdown voltage ($-I_C = 10 \mu\text{A}$)	$-V_{(BR)CBO} > 250$	> 300	V
Collector-emitter breakdown voltage ($-I_C = 1 \mu\text{A}$)	$-V_{(BR)CEO} > 250$	—	V
Collector-emitter breakdown voltage ($R_{BE} = 2.7 \text{ k}\Omega$)	$-V_{(BR)CER} -$	> 300	V
Emitter-base breakdown voltage ($I_E = 10 \mu\text{A}$)	$-V_{(BR)EBO} > 5$	> 5	V
Collector cutoff current ($-V_{CE} = 200 \text{ V}; R_{BE} = 2.7 \text{ k}\Omega; T_{amb} = 150^{\circ}\text{C}$)	$-I_{CER} \leq 10$	≤ 10	μA
Collector cutoff current ($-V_{CB} = 200 \text{ V}$)	$-I_{CBO} \leq 10$	≤ 10	nA
Emitter cutoff current ($-V_{EB} = 5 \text{ V}$)	$-I_{EBO} \leq 10$	≤ 10	μA
Collector-emitter saturation voltage ($-I_C = 25 \text{ mA}; T_j = 150^{\circ}\text{C}$)	$-V_{CEsat \text{ RF}} 20$	—	V
($-I_C = 25 \text{ mA}; T_{amb} = 150^{\circ}\text{C}$)	—	20	V
DC current gain ($-I_C = 25 \text{ mA}; -V_{CE} = 20 \text{ V}$)	$h_{FE} \geq 50$	≥ 40	—

Dynamic characteristics ($T_{amb} = 25^{\circ}\text{C}$)

Transition frequency ($V_{CE} = 10 \text{ V}; -I_C = 10 \text{ mA}$);	$f_T \geq 60$	≥ 60	MHz
Reverse transfer capacitance ($-V_{CB} = 30 \text{ V}$)	$-C_{12e} \leq 1.8$	≤ 1.8	pF
Feedback time constant ($-V_{CB} = 20 \text{ V}; I_E = 10 \text{ mA}; f = 10.7 \text{ MHz}$)	$r_{bb' \text{ } C_{b'c}} \leq 90$	≤ 90	ps

Total perm. power dissipation versus temperature

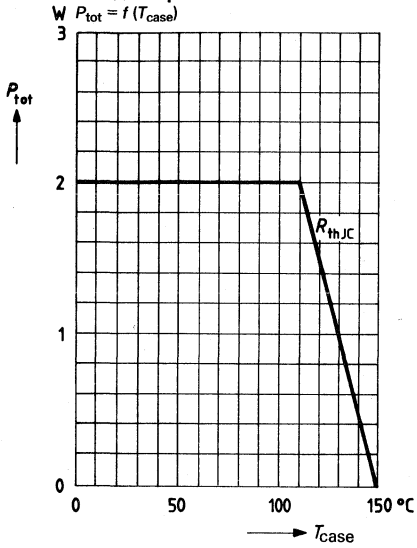

DC current gain $h_{FE} = f(I_C)$

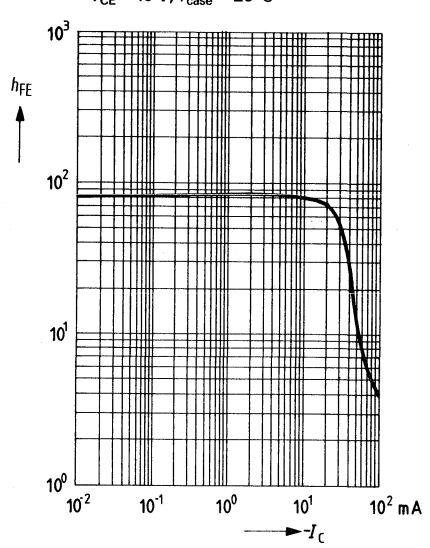

Collector current $I_C = f(V_{BE})$

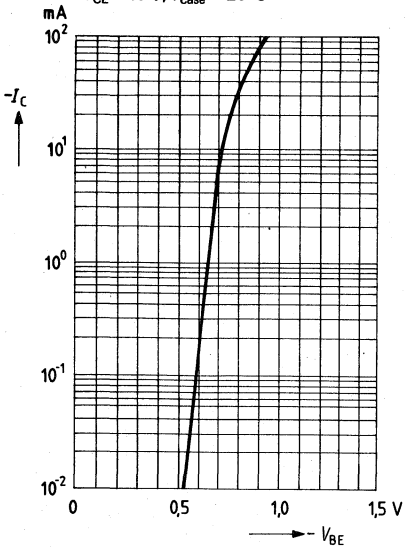

Transition frequency $f_T = f(I_C)$

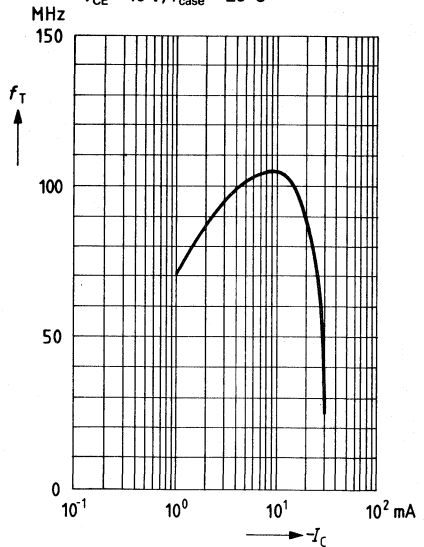

BF 502 is an NPN silicon planar RF transistor in TO 92 plastic package (10 A 3 DIN 41868). The transistor is particularly intended for use in VHF amplifiers, VHF mixers, and VHF oscillators.

Type	Ordering code
BF 502	Q62702-F572

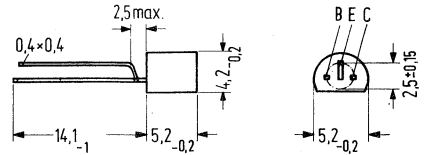

Approx. weight 0.25 g Dimensions in mm

Maximum ratings ($T_{amb} = 25^{\circ}\text{C}$)

Collector-emitter voltage	V_{CE0}	30	V
Collector-base voltage	V_{CB0}	40	V
Emitter-base voltage	V_{EBO}	4	V
Collector current	I_C	20	mA
Collector peak current	I_{CM}	50	mA
Base current	I_B	5	mA
Junction temperature	T_j	150	$^{\circ}\text{C}$
Storage temperature range	T_{stg}	-55 to +150	$^{\circ}\text{C}$
Total power dissipation	P_{tot}	500	mW

Thermal resistance

Junction to ambient air	R_{thJA}	≤ 250	K/W
-------------------------	------------	------------	-----

Static characteristics ($T_{amb} = 25^{\circ}\text{C}$)

Collector cutoff current ($V_{CB0} = 25\text{ V}$)	I_{CBO}	≤ 100	nA
Collector-emitter breakdown voltage ($I_C = 1\text{ mA}$)	$V_{(BR)CEO}$	≥ 30	V
Collector-base breakdown voltage ($I_C = 10\text{ }\mu\text{A}$)	$V_{(BR)CBO}$	≥ 40	V
Emitter-base breakdown voltage ($I_E = 10\text{ }\mu\text{A}$)	$V_{(BR)EBO}$	≥ 4	V
DC current gain ($I_C = 1\text{ mA}$; $V_{CE} = 10\text{ V}$)	h_{FE}	≥ 30	-
($I_C = 5\text{ mA}$; $V_{CE} = 10\text{ V}$)	h_{FE}	≥ 40	-
Collector-emitter saturation voltage ($I_C = 5\text{ mA}$; $I_B = 0.5\text{ mA}$)	V_{CEsat}	≤ 0.6	V

Dynamic characteristics ($T_{amb} = 25^{\circ}\text{C}$)

Transition frequency ($I_C = 5\text{ mA}$; $V_{CE} = 10\text{ V}$; $f = 100\text{ MHz}$)	f_T	700 (≥ 350)	MHz
Noise figure ($I_C = 3\text{ mA}$; $V_{CE} = 10\text{ V}$; $f = 200\text{ MHz}$; $R_g = 60\text{ }\Omega$)	NF	3 (<5)	dB
Collector-base capacitance ($f = 1\text{ MHz}$; $V_{CB} = 10\text{ V}$; $V_{BE} = 0\text{ V}$) ¹⁾	C_{CB}	≤ 0.35	pF
Output admittance ($I_C = 1\text{ mA}$; $V_{CE} = 10\text{ V}$; $f = 10.7\text{ MHz}$)	g_{22e}	≤ 10.5	μS

1) Third terminal at screening potential.

BF 503 is an NPN silicon planar RF transistor in TO 92 plastic package (10 A 3 DIN 41868). The transistor is particularly intended for use in VHF amplifiers, VHF mixers, and VHF oscillators.

Type	Ordering code
BF 503	Q62702-F574

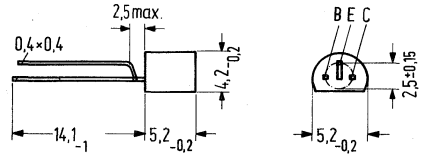

Approx. weight 0.25 g

Dimensions in mm

Maximum ratings ($T_{amb} = 25^{\circ}\text{C}$)

Collector-emitter voltage	V_{CEO}	30	V
Collector-base voltage	V_{CBO}	40	V
Emitter-base voltage	V_{EBO}	4	V
Collector current	I_C	20	mA
Collector peak current	I_{CM}	50	mA
Base current	I_B	5	mA
Junction temperature	T_j	150	$^{\circ}\text{C}$
Storage temperature range	T_{stg}	-55 to +150	$^{\circ}\text{C}$
Total power dissipation	P_{tot}	500	mW

Thermal resistance

Junction to ambient air	R_{thJA}	≤ 250	K/W
-------------------------	------------	------------	-----

Static characteristics ($T_{amb} = 25^{\circ}\text{C}$)

Collector cutoff current ($V_{CBO} = 25\text{ V}$)	I_{CBO}	≤ 100	nA
Collector-emitter breakdown voltage ($I_C = 1\text{ mA}$)	$V_{(BR)CEO}$	≥ 30	V
Collector-base breakdown voltage ($I_C = 10\text{ }\mu\text{A}$)	$V_{(BR)CBO}$	≥ 40	V
Emitter-base breakdown voltage ($I_E = 10\text{ }\mu\text{A}$)	$V_{(BR)EBO}$	≥ 4	V
DC current gain ($I_C = 1\text{ mA}$; $V_{CE} = 10\text{ V}$)	h_{FE}	≥ 30	–
($I_C = 5\text{ mA}$; $V_{CE} = 10\text{ V}$)	h_{FE}	≥ 40	–
Collector-emitter saturation voltage ($I_C = 5\text{ mA}$; $I_B = 0.5\text{ mA}$)	V_{CEsat}	≤ 0.6	V

Dynamic characteristics ($T_{amb} = 25^{\circ}\text{C}$)

Transition frequency ($I_C = 5\text{ mA}$; $V_{CE} = 10\text{ V}$; $f = 100\text{ MHz}$)	f_T	750 (≥ 400)	MHz
Noise figure ($I_C = 3\text{ mA}$; $V_{CE} = 10\text{ V}$; $f = 200\text{ MHz}$; $R_g = 60\text{ }\Omega$)	NF	3 (<5)	dB
Collector-base capacitance ($f = 1\text{ MHz}$; $V_{CB} = 10\text{ V}$; $V_{BE} = 0\text{ V}$) ¹⁾	C_{CB}	0.55 (<0.7)	pF
Collector-emitter capacitance ($f = 1\text{ MHz}$; $V_{CE} = 10\text{ V}$; $V_{BE} = 0\text{ V}$) ¹⁾	C_{CE}	≤ 0.65	pF
Output admittance ($I_C = 1\text{ mA}$; $V_{CE} = 10\text{ V}$; $f = 10.7\text{ MHz}$)	g_{22e}	≤ 10.5	μS

1) Third terminal at creening potential.

BF 505 is an NPN silicon planar RF transistor in TO 92 plastic package (10 A 3 DIN 41868). The transistor is particularly intended for use in VHF amplifiers in common emitter configuration, VHF mixers and VHF/UHF oscillators.

Type	Ordering code
BF 505	Q62702-F573

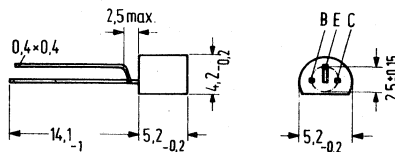

Approx. weight 0.25 g

Dimensions in mm

Maximum ratings ($T_{amb} = 25^{\circ}\text{C}$)

Collector-emitter voltage	V_{CEO}	25	V
Collector-base voltage	V_{CBO}	30	V
Emitter-base voltage	V_{EBO}	3	V
Collector current	I_C	20	mA
Collector peak current	I_{CM}	50	mA
Base current	I_B	5	mA
Junction temperature	T_j	150	$^{\circ}\text{C}$
Storage temperature range	T_{stg}	-55 to +150	$^{\circ}\text{C}$
Total power dissipation	P_{tot}	500	mW

Thermal resistance

Junction to ambient air	R_{thJA}	≤ 250	K/W
-------------------------	------------	------------	-----

Static characteristics ($T_{amb} = 25^{\circ}\text{C}$)

Collector cutoff current ($V_{CBO} = 25\text{ V}$)	I_{CBO}	≤ 100	nA
Collector-emitter breakdown voltage ($I_C = 1\text{ mA}$)	$V_{(BR)CEO}$	≥ 25	V
Collector-base breakdown voltage ($I_C = 10\text{ }\mu\text{A}$)	$V_{(BR)CBO}$	≥ 30	V
Emitter-base breakdown voltage ($I_E = 10\text{ }\mu\text{A}$)	$V_{(BR)EBO}$	≥ 3	V
DC current gain ($I_C = 1\text{ mA}$; $V_{CE} = 10\text{ V}$)	h_{FE}	≥ 30	—
($I_C = 5\text{ mA}$; $V_{CE} = 10\text{ V}$)	h_{FE}	≥ 40	—
Base-emitter voltage ($I_C = 5\text{ mA}$; $V_{CE} = 10\text{ V}$)	V_{BE}	≤ 0.95	V
Collector-emitter saturation voltage ($I_C = 5\text{ mA}$; $I_B = 0.5\text{ mA}$)	V_{CEsat}	≤ 0.6	V

Dynamic characteristics ($T_{amb} = 25^{\circ}\text{C}$)

Transition frequency ($I_C = 5\text{ mA}$; $V_{CE} = 10\text{ V}$; $f = 100\text{ MHz}$)	f_T	≥ 750	MHz
Noise figure ($I_C = 3\text{ mA}$; $V_{CE} = 10\text{ V}$; $f = 200\text{ MHz}$; $R_g = 60\text{ }\Omega$)	NF	3	dB
Collector-base capacitance ($f = 1\text{ MHz}$; $V_{CB} = 10\text{ V}$; $V_{BE} = 0\text{ V}$) ¹⁾	C_{CB}	≤ 0.5	pF
Collector-emitter capacitance ($f = 1\text{ MHz}$; $V_{CB} = 10\text{ V}$; $V_{BE} = 0\text{ V}$) ¹⁾	C_{CE}	≤ 1.1	pF

1) Third terminal at screening potential

BF 506 is a PNP silicon planar transistor in TO 92 plastic package (10 A.3 DIN 41868). The transistor is particularly intended for low-noise, large-signal VHF mixer and oscillator stages in common base configuration.

Type	Ordering code
BF 506	Q62702-F534

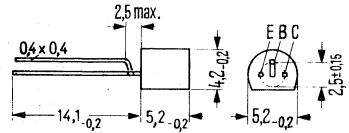

Mounting instruction: Fixing hole dia 0.6
Approx. weight 0.25 g Dimensions in mm

Maximum ratings

Collector-emitter voltage	$-V_{CEO}$	35	V
Collector-base voltage	$-V_{CBO}$	40	V
Emitter-base voltage	$-V_{EBO}$	4	V
Collector current	$-I_C$	30	mA
Base current	$-I_B$	5	mA
Junction temperature	T_j	150	°C
Storage temperature range	T_{stg}	-55 to +150	°C
Total power dissipation ($T_{amb} = 45^\circ\text{C}$)	P_{tot}	300	mW

Thermal resistance

Junction to ambient air	R_{thJA}	< 350	K/W
-------------------------	------------	-------	-----

Static characteristics ($T_{amb} = 25^\circ\text{C}$)

Collector cutoff current ($-V_{CB} = 20\text{ V}$)	$-I_{CBO}$	100	nA
Collector-emitter breakdown voltage ($-I_C = 10\text{ mA}$)	$-V_{(BR) CEO}$	> 35	V
Collector-base breakdown voltage ($-I_C = 10\text{ }\mu\text{A}$)	$-V_{(BR) CBO}$	> 40	V
Emitter-base breakdown voltage ($-I_E = 10\text{ }\mu\text{A}$)	$-V_{(BR) EBO}$	> 4	V
DC current gain ($-V_{CE} = 10\text{ V}; -I_C = 3\text{ mA}$)	h_{FE}	25	-

Dynamic characteristics ($T_{\text{amb}} = 25^{\circ}\text{C}$)

Transition frequency

($-I_{\text{C}} = 2 \text{ mA}$; $-V_{\text{CE}} = 10 \text{ V}$; $f = 100 \text{ MHz}$)

f_{T}	550	MHz
----------------	-----	-----

Reverse transfer capacitance

($-V_{\text{CE}} = 10 \text{ V}$; $f = 1 \text{ MHz}$)

$C_{12\text{b}}$	0.1	pF
------------------	-----	----

Noise figure

($-I_{\text{C}} = 2 \text{ mA}$; $-V_{\text{CB}} = 10 \text{ V}$; $f = 200 \text{ MHz}$; $R_{\text{g}} = 60 \Omega$)

NF	3	dB
------	---	----

BF 507 is an NPN silicon planar RF transistor in TO 92 plastic package (10 A 3 DIN 41868). The transistor is particularly intended for use in VHF amplifiers, VHF mixers and VHF/UHF oscillators.

Type	Ordering code
BF 507	Q62702-F571

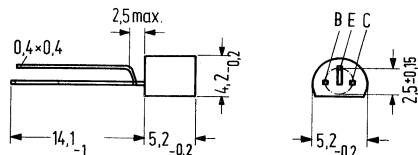

Approx. weight 0.25 g

Dimensions in mm

Maximum ratings ($T_{amb} = 25^{\circ}\text{C}$)

- Collector-emitter voltage
- Collector-base voltage
- Emitter-base voltage
- Collector current
- Collector peak current
- Base current
- Junction temperature
- Storage temperature range
- Total power dissipation

V_{CEO}	25	V
V_{CBO}	30	V
V_{EBO}	3	V
I_C	20	mA
I_{CM}	50	mA
I_B	5	mA
T_j	150	$^{\circ}\text{C}$
T_{stg}	-55 to +150	$^{\circ}\text{C}$
P_{tot}	500	mW

Thermal resistance

Junction to ambient air	R_{thJA}	≤ 250	K/W
-------------------------	------------	------------	-----

Static characteristics ($T_{amb} = 25^{\circ}\text{C}$)

Collector cutoff current ($V_{CBO} = 25\text{ V}$)	I_{CBO}	≤ 100	nA
Collector-emitter breakdown voltage ($I_C = 1\text{ mA}$)	$V_{(BR)CEO}$	≥ 25	V
Collector-base breakdown voltage ($I_C = 10\text{ }\mu\text{A}$)	$V_{(BR)CBO}$	≥ 30	V
Emitter-base breakdown voltage ($I_E = 10\text{ }\mu\text{A}$)	$V_{(BR)EBO}$	≥ 3	V
DC current gain ($I_C = 1\text{ mA}$; $V_{CE} = 10\text{ V}$)	h_{FE}	≥ 30	–
($I_C = 5\text{ mA}$; $V_{CE} = 10\text{ V}$)	h_{FE}	≥ 40	–
Base-emitter voltage ($I_C = 5\text{ mA}$; $V_{CE} = 10\text{ V}$)	V_{BE}	≤ 0.95	V
Collector-emitter saturation voltage ($I_C = 5\text{ mA}$; $I_B = 0.5\text{ mA}$)	V_{CEsat}	≤ 0.6	V

Dynamic characteristics ($T_{amb} = 25^{\circ}\text{C}$)

Transition frequency ($I_C = 5\text{ mA}$; $V_{CE} = 10\text{ V}$; $f = 100\text{ MHz}$)	f_T	≥ 750	MHz
Noise figure ($I_C = 3\text{ mA}$; $V_{CE} = 10\text{ V}$; $f = 200\text{ MHz}$; $R_g = 60\text{ }\Omega$)	NF	3	dB
Collector-base capacitance ($f = 1\text{ MHz}$; $V_{BE} = 0\text{ V}$) ¹⁾	C_{CB}	≤ 0.75	pF
Collector-emitter capacitance ($f = 1\text{ MHz}$; $V_{CB} = 10\text{ V}$; $V_{BE} = 0\text{ V}$) ¹⁾	C_{CE}	0.35 to 0.65	pF

1) Third terminal at screening potential

BF 550 is an epitaxial PNP silicon planar transistor in TO 236 plastic package (23 A 3 DIN 41869). The transistor is particularly intended for use in AM stages, AM/FM/IF stages, VHF tuners, and TV VHF mixer stages in common emitter configuration for film circuits. The transistor is marked with the code letters "LA".

Type	Mark	Ordering code
BF 550	LA	Q62702-F547

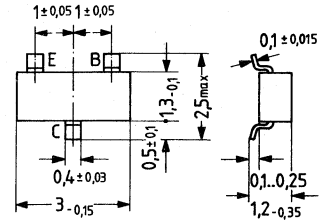

Approx. weight 0.02 g Dimensions in mm

Maximum ratings

Collector-emitter voltage
 Collector-base voltage
 Emitter-base voltage
 Collector current
 Base current
 Junction temperature
 Storage temperature range
 Total power dissipation ($T_{SB} < 65^\circ\text{C}$)

$-V_{CEO}$	40	V
$-V_{CBO}$	40	V
$-V_{EBO}$	4	V
$-I_C$	25	mA
$-I_B$	5	mA
T_j	125	$^\circ\text{C}$
T_{stg}	-55 to +125	$^\circ\text{C}$
P_{tot}	150	mW

Thermal resistance

Junction to ambient air
 Junction to substrate back¹⁾

R_{thJA}	< 530	K/W
R_{thJSB}	< 430	K/W

1) Ceramic substrate 0.7 mm; 2.5 cm² area

Static characteristics ($T_{amb} = 25^\circ\text{C}$)

Collector-base breakdown voltage ($-I_C = 10\ \mu\text{A}$)	$-V_{(BR)CBO}$	>40	V
Collector-emitter breakdown voltage ($-I_C = 2\ \text{mA}$)	$-V_{(BR)CEO}$	>40	V
Emitter-base breakdown voltage ($I_E = 10\ \mu\text{A}$)	$-V_{(BR)EBO}$	>4	V
Collector-base reverse current ($-V_{CB} = 30\ \text{V}$)	$-I_{CBO}$	<50	nA
DC current gain ($-I_C = 1\ \text{mA}$; $-V_{CE} = 10\ \text{V}$)	h_{FE}	>50	-
Base-emitter forward voltage ($-I_C = 1\ \text{mA}$; $-V_{CE} = 10\ \text{V}$)	$-V_{BE}$	0.72	V

Dynamic characteristics ($T_{amb} = 25^\circ\text{C}$)

Transition frequency ($-I_C = 1\ \text{mA}$; $-V_{CE} = 10\ \text{V}$; $f = 100\ \text{MHz}$)	f_T	375	MHz
Reverse transfer capacitance ($-I_C = 1\ \text{mA}$; $-V_{CE} = 10\ \text{V}$; $f = 1\ \text{MHz}$)	$-C_{12e}$	0.35	pF
Output admittance ($-I_C = 1\ \text{mA}$; $-V_{CE} = 10\ \text{V}$; $f = 450\ \text{kHz}$)	g_{22e}	<8	μS
$f = 10\ \text{MHz}$	g_{22e}	<10	μS
Noise figure ($-I_C = 1\ \text{mA}$; $-V_{CE} = 10\ \text{V}$; $f = 100\ \text{kHz}$; $R_g = 300\ \Omega$)	NF	2	dB
($-I_C = 2\ \text{mA}$; $-V_{CE} = 10\ \text{V}$; $f = 100\ \text{kHz}$; $R_g = 60\ \Omega$)	NF	3.4	dB

Four-pole characteristics

($-I_C = 1\ \text{mA}$; $-V_{CE} = 10\ \text{V}$) $f = 0.45\ \text{to}\ 10\ \text{MHz}$)	g_{11e}	0.55	mS
	C_{11e}	17	pF
	Y_{21e}	35	mS
	g_{22e}	5	μS
	C_{22e}	1.3	pF

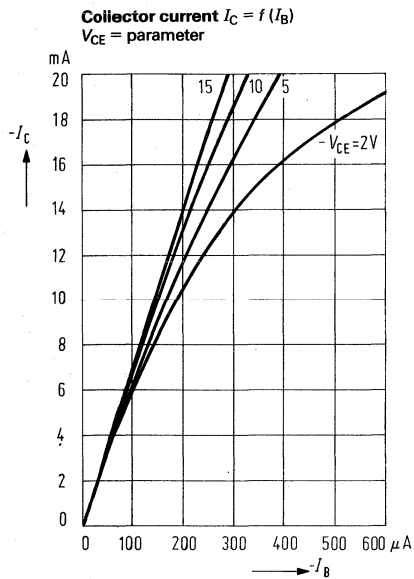
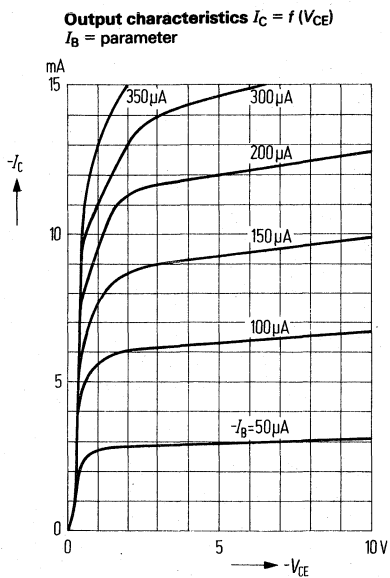
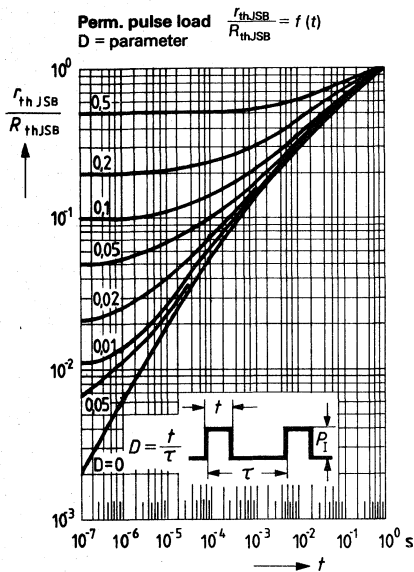
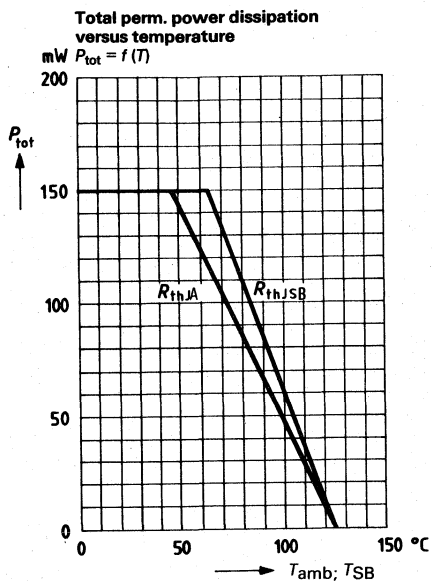

Transition frequency $f_T = f(I_C)$
 $V_{CE} = \text{parameter}; f = 100 \text{ MHz}$

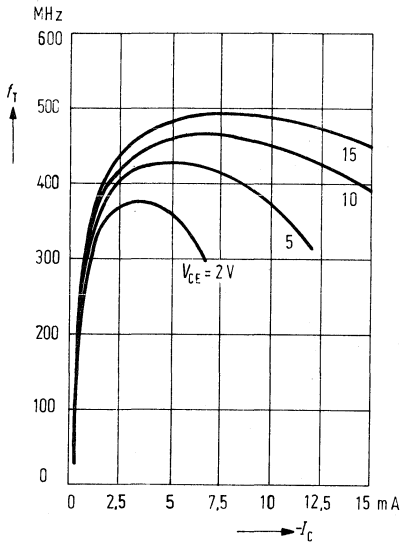

Output admittance $g_{22e} = f(I_C)$
 $V_{CE} = 10 \text{ V}; f = 500 \text{ kHz}$

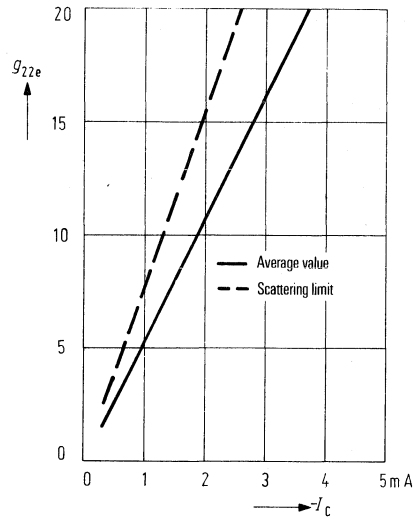

Short-circuit forward transfer admittance (Y_{21e}) = $f(I_C)$
 $V_{CE} = \text{parameter}; f = 10.7 \text{ MHz}$

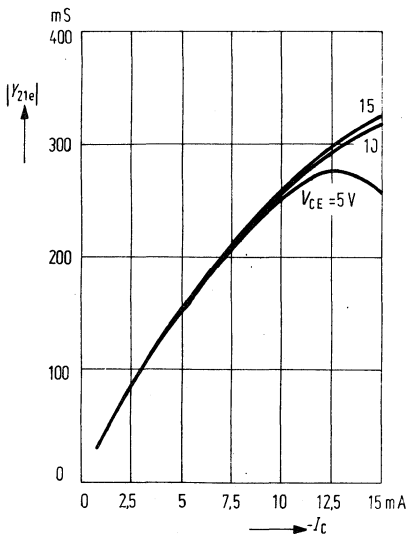

Short-circuit forward transfer admittance (Y_{21e}); $-V_{CE} = 10 \text{ V}$

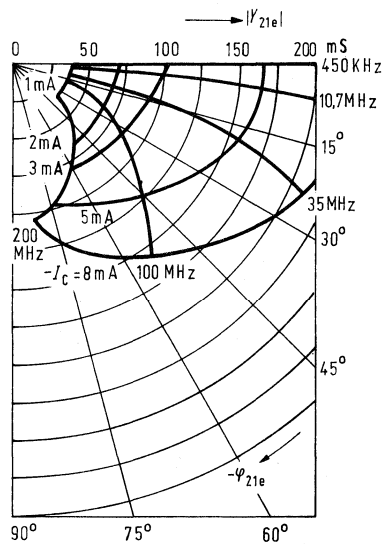

BF 554 is an epitaxial NPN silicon planar high-frequency transistor in TO 236 plastic package (23 A 3 DIN 41869). The transistor is intended for use in AM/FM/IF amplifiers as well as in input stages throughout the short, medium, and long wave range as well as in VHF TV mixer stages for film circuits. The transistor is marked on its package with the code letters >CC<.

Type	Mark	Ordering code
BF 554	CC	Q62702-F551

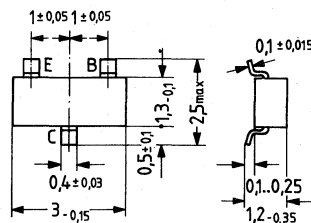

Approx. weight 0.02 g Dimensions in mm

Maximum ratings

Collector-base voltage
 Collector-emitter voltage
 Emitter-base voltage
 Collector current
 Junction temperature
 Storage temperature range
 Total power dissipation ($T_{SB} = 65^\circ\text{C}$)

V_{CBO}	30	V
V_{CEO}	20	V
V_{EBO}	5	V
I_C	30	mA
T_j	125	$^\circ\text{C}$
T_{stg}	-55 to +125	$^\circ\text{C}$
P_{tot}	150	mW

Thermal resistance

Junction to ambient air
 Junction to substrate back¹⁾

R_{thJA}	500	K/W
R_{thJSB}	400	K/W

1) Ceramic substrate 0.7 mm; 2.5 cm² area

Static characteristics ($T_{amb} = 25^{\circ}\text{C}$)

Base-emitter voltage ($V_{CE} = 10\text{ V}; I_C = 1\text{ mA}$)
 DC current gain ($V_{CE} = 10\text{ V}; I_C = 1\text{ mA}$)

V_{BE}	0.68	V
h_{FE}	115	-

Dynamic characteristics ($T_{amb} = 25^{\circ}\text{C}$)

Transition frequency
 ($V_{CE} = 10\text{ V}; I_C = 1\text{ mA}, f = 100\text{ MHz}$)
 Noise figure ($V_{CE} = 10\text{ V}; I_C = 1\text{ mA}$)
 at $f = 200\text{ kHz}, g_g = 2\text{ mS}^1$
 at $f = 1\text{ MHz}, g_g = 1.5\text{ mS}^1$
 at $f = 100\text{ MHz}, g_g = 10\text{ mS}^1$
 Mixed noise figure ($V_{CE} = 10\text{ V}; I_C = 1\text{ mA}$)
 at $f = 200\text{ kHz}; g_g = 0.6\text{ mS}^1$
 at $f = 1\text{ MHz}; g_g = 1.2\text{ mS}^1$
 Reverse transfer capacitance
 ($V_{CE} = 10\text{ V}; I_C = 1\text{ mA}; f = 450\text{ kHz}$)
 Output admittance
 ($I_C = 1\text{ mA}, V_{CE} = 10\text{ V}; f = 0.5\text{-}10\text{ MHz}$)

f_T	260	MHz
NF	1.5	dB
NF	1.2	dB
NF	4	dB
NF_C	3	dB
NF_C	2	dB
$-C_{12e}$	0.85	pF
g_{22e}	4 (<10)	μS

Total perm. power dissipation versus temperature
 $P_{tot} = f(T)$

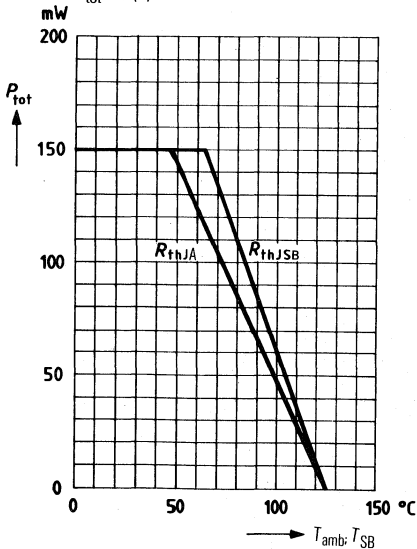

Perm. pulse load $\frac{r_{thJSB}}{R_{thJSB}} = f(t)$
 D = parameter

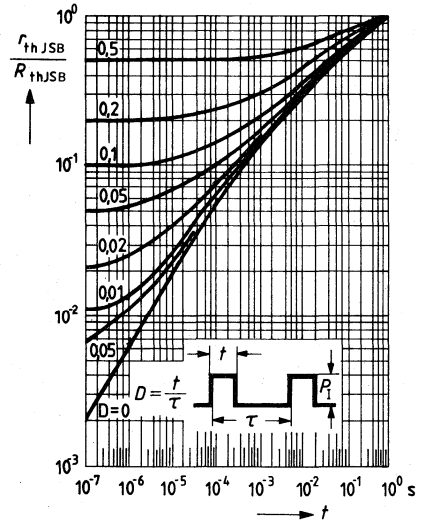

1) g internal admittance of generator $\left(\frac{1}{R_C}\right)$

BF 562 is an NPN silicon RF transistor in TO 92 plastic package (10 A 3 DIN 41868). The transistor is particularly suitable for controllable VHF input stages in TV tuners.

Type	Ordering code
BF 562	Q62702-F542

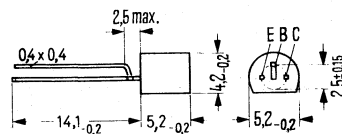

Mounting instruction: Fixing hole dia 0.6
Approx. weight 0.25 g Dimensions in mm

Maximum ratings ($T_{amb} = 25^{\circ}\text{C}$)

Collector-emitter voltage	V_{CE0}	20	V
Collector-base voltage	V_{CB0}	30	V
Emitter-base voltage	V_{EB0}	3	V
Collector current	I_C	20	mA
Junction temperature	T_j	150	$^{\circ}\text{C}$
Storage temperature range	T_{stg}	-55 to +150	$^{\circ}\text{C}$
Total power dissipation ($T_{amb} \leq 45^{\circ}\text{C}$)	P_{tot}	250	mW

		20	V
		30	V
		3	V
		20	mA
		150	$^{\circ}\text{C}$
		-55 to +150	$^{\circ}\text{C}$
		250	mW

Thermal resistance

Junction to ambient air

R_{thJA}	≤ 420	K/W
------------	------------	-----

Static characteristics ($T_{amb} = 25^{\circ}\text{C}$)

Base current ($I_C = 3 \text{ mA}; V_{CE} = 10 \text{ V}$)	I_B	≤ 150	μA
($I_C = 10 \text{ mA}; V_{CE} = 7 \text{ V}$)	I_B	≤ 2	mA
Collector-emitter breakdown voltage ($I_C = 1 \text{ mA}$)	$V_{(BR)CEO}$	≥ 20	V
Collector-base breakdown voltage ($I_C = 10 \mu\text{A}$)	$V_{(BR)CBO}$	≥ 30	V
Emitter-base breakdown voltage ($I_E = 10 \mu\text{A}$)	$V_{(BR)EBO}$	≥ 3	V

Dynamic characteristics ($T_{amb} = 25^{\circ}\text{C}$)

Transition frequency ($I_C = 2.5 \text{ mA}; V_{CE} = 10 \text{ V}; f = 100 \text{ MHz}$)	f_T	600	MHz
Power gain ($I_C = 2.5 \text{ mA}; V_{CE} = 10 \text{ V}; f = 200 \text{ MHz};$ $R_g = 60 \Omega; R_L = 920 \Omega$)	G_{pb}	16	dB
Noise figure ($I_C = 2.5 \text{ mA}; V_{CE} = 10 \text{ V}; f = 200 \text{ MHz};$ $R_g = 60 \Omega$)	NF	3	dB
Reverse transfer capacitance ($I_C = 1 \text{ mA}; V_{CE} = 10 \text{ V}; f = 1 \text{ MHz}$)	$-C_{12e}$	0.65	pF
Reverse transfer capacitance ($V_{BE} = 0; V_{CB} = 10 \text{ V}; f = 1 \text{ MHz}$)	$-C_{12b}$	0.12	pF

BF 568 is a PNP silicon planar transistor with passivated surface in TO 236 plastic package (23 A 3 DIN 4.1869). The transistor is particularly suitable for use in low-noise gain-controlled VHF and UHF input stages of film circuits. The transistor is marked with the code letters "LK".

Type	Mark	Ordering code
BF 568	LK	Q62702-F626

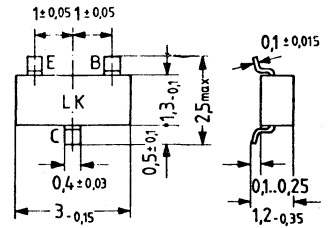

Approx. weight 0.02 g Dimensions in mm

Maximum ratings

Collector-emitter voltage	$-V_{CEO}$	35	V
Collector-base voltage	$-V_{CBO}$	40	V
Emitter-base voltage	$-V_{EBO}$	3	V
Collector current	$-I_C$	30	mA
Base current	$-I_B$	5	mA
Junction temperature	T_j	150	°C
Storage temperature range	T_{stg}	-55 to +150	°C
Total power dissipation ($T_{SB} = 60^\circ\text{C}$)	P_{tot}	220	mW

Thermal resistance

Junction to ambient air	R_{thJA}	< 500	K/W
Junction to substrate back ¹⁾	R_{thJSB}	< 410	K/W

1) Ceramic substrate 0.7 mm 2.5 cm² area

Static characteristics ($T_{amb} = 25^{\circ}\text{C}$)

Collector cutoff current ($-V_{CBO} = 15\text{ V}$)
 Emitter cutoff current ($-V_{EBO} = 3\text{ V}$)
 DC current gain ($-V_{CE} = 10\text{ V}; -I_C = 1\text{ mA}$)

$-I_{CBO}$	1 (<100)	nA
$-I_{EBO}$	< 10	μA
h_{FE}	60 (>25)	-

Dynamic characteristics ($T_{amb} = 25^{\circ}\text{C}$)

Transition frequency
 ($-I_C = 3\text{ mA}; -V_{CE} = 10\text{ V}; f = 100\text{ MHz}$)
 Collector-base capacitance
 ($-V_{CB} = 10\text{ V}; f = 1\text{ MHz}$)
 Power gain
 ($-I_C = 3\text{ mA}; -V_{CB} = 10\text{ V}; f = 800\text{ MHz}$,
 $R_L = 500\ \Omega$)
 Noise figure
 ($-I_C = 3\text{ mA}; -V_{CB} = 10\text{ V}; R_g = 60\ \Omega$;
 $f = 800\text{ MHz}$)
 ($-I_C = 3\text{ mA}; -V_{CB} = 10\text{ V}; R_g = 60\ \Omega$;
 $f = 200\text{ MHz}$)
 Collector current for G_{pbmax}
 ($V_{CC} = 12\text{ V}; R_{CC} = 1\text{ k}\Omega; f = 800\text{ MHz}$;
 $R_L = 500\ \Omega$)

f_T	1.1	GHz
C_{CBO}	0.35	pF
G_{pb}	14.5	dB
NF	3 (<4)	dB
NF	2.5	dB
I_C	3.5	mA

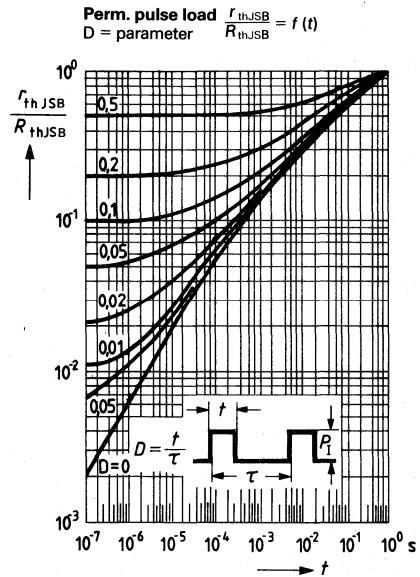
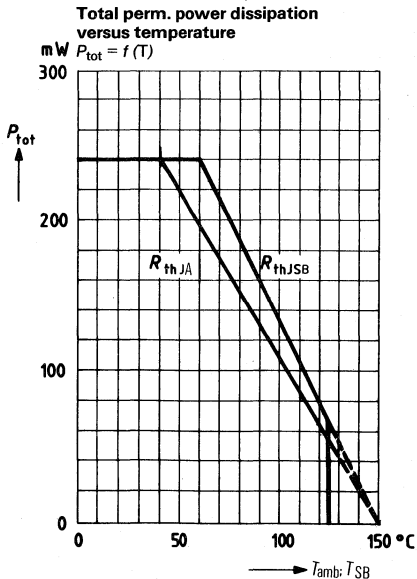

BF 569 is a PNP silicon planar transistor in TO 236 plastic package (23 A 3 DIN 869). The transistor is particularly intended for use in UHF mixer and oscillator stages for film circuits. The transistor is marked on the package with the code letters "LH".

Type	Mark	Ordering code
BF 569	LH	Q62702-F548

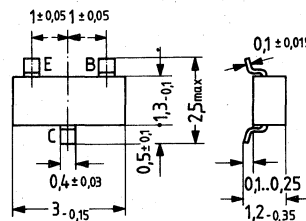

Approx. weight 0.02 g Dimensions in mm

Maximum ratings

Collector-emitter voltage	$-V_{CEO}$	35	V
Collector-base voltage	$-V_{CBO}$	40	V
Emitter-base voltage	$-V_{EBO}$	3	V
Collector current	$-I_C$	30	mA
Base current	$-I_B$	5	mA
Junction temperature	T_j	150	°C
Storage temperature range	T_{stg}	-55 to +125	°C
Total power dissipation ($T_{SB} = 60^\circ\text{C}$)	P_{tot}	220	mW

Thermal resistance

Junction to ambient air	R_{thJA}	< 500	K/W
Junction to substrate back ¹⁾	R_{thJSB}	< 410	K/W

1) Ceramic substrate 0.7 mm; 2.5 cm² area

Static characteristics ($T_{amb} = 25^{\circ}\text{C}$)

Collector cutoff current

($-V_{CB0} = 20\text{ V}$)

DC current gain

($-I_C = 3\text{ mA}$; $-V_{CE} = 10\text{ V}$)

$-I_{CBO}$	< 100	nA
h_{FE}	50 (>25)	—

Dynamic characteristics ($T_{amb} = 25^{\circ}\text{C}$)

Transition frequency

($-I_C = 3\text{ mA}$; $-V_{CE} = 10\text{ V}$; $f = 100\text{ MHz}$)

Collector-base capacitance

($-V_{CB} = 10\text{ V}$; $f = 1\text{ MHz}$)

Noise figure

($-I_C = 3\text{ mA}$; $-V_{CB} = 10\text{ V}$; $R_g = 60\ \Omega$;

$f = 800\text{ MHz}$)

Power gain

($-I_C = 3\text{ mA}$; $-V_{CB} = 10\text{ V}$; $f = 800\text{ MHz}$;

$R_L = 500\ \Omega$)

f_T	850	MHz
C_{CBO}	0.31	pF
NF	4.5	dB
G_{pb}	12.5	dB

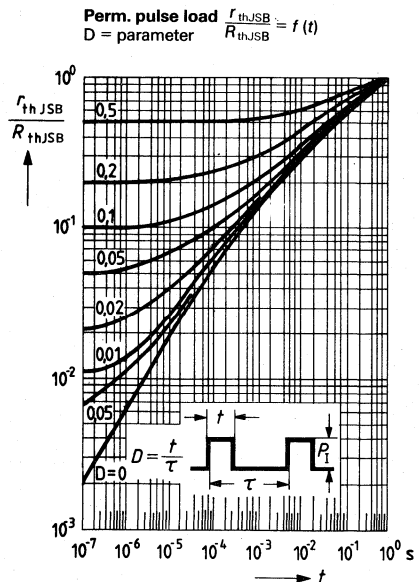
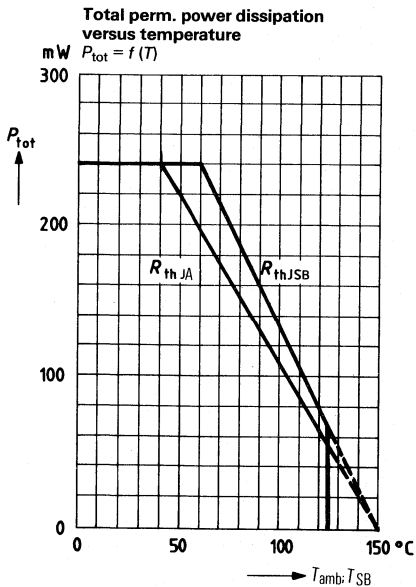

BF 579 is a PNP silicon UHF planar transistor in TO 236 plastic package (23 A 3 DIN 41869). The transistor is particularly suitable for use in uncontrolled UHF and VHF input stages of low cross modulation for film circuits. The transistor is marked on the package with the code letters "LJ".

Type	Mark	Ordering code
BF 579	LJ	Q62702-F552

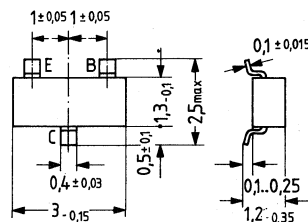

Approx. weight 0.02 g Dimensions in mm

Maximum ratings

Collector-emitter voltage	$-V_{CE0}$	20	V
Collector-base voltage	$-V_{CBS}$	25	V
Emitter-base voltage	$-V_{EBO}$	3	V
Collector current	$-I_C$	30	mA
Junction temperature	T_j	150	°C
Storage temperature range	T_{stg}	-55 to +125	°C
Total power dissipation ($T_{SB} = 60^\circ\text{C}$)	P_{tot}	220	mW

Thermal resistance

Junction to ambient air	R_{thJA}	< 500	K/W
Junction to substrate back ¹⁾	R_{thJSB}	< 410	K/W

1) Ceramic substrate 0.7 mm; 2.5 cm² area

Static characteristics ($T_{amb} = 25^{\circ}\text{C}$)

Collector cutoff current ($-V_{CB0} = 20\text{ V}$)
 DC current gain ($-I_C = 10\text{ mA}$; $-V_{CE} = 10\text{ V}$)

$-I_{CB0}$	< 100	nA
h_{FE}	> 20	-

Dynamic characteristics ($T_{amb} = 25^{\circ}\text{C}$)

Transition frequency
 ($-I_C = 10\text{ mA}$; $-V_{CE} = 10\text{ V}$; $f = 100\text{ MHz}$)
 Collector-base capacitance ($-V_{CB} = 10\text{ V}$; $f = 1\text{ MHz}$)

f_T	1.6	GHz
C_{CB0}	0.55	pF

Noise figure
 ($-I_C = 10\text{ mA}$; $-V_{CB} = 10\text{ V}$; $R_g = 60\ \Omega$);
 $f = 200\text{ MHz}$

NF	2.9	dB
NF	4.2	dB

Noise figure ($f = 800\text{ MHz}$)
 Power gain
 ($-I_C = 10\text{ mA}$; $-V_{CB} = 10\text{ V}$; $f = 800\text{ MHz}$;
 $R_L = 500\ \Omega$)

G_{pb}	16	dB
----------	----	----

Interference voltage¹⁾
 ($-I_C = 10\text{ mA}$; $-V_{CB} = 10\text{ V}$; $f_M = 200\text{ MHz}$;
 $R_g = 75\ \Omega$)

$V_{int1\%}$	230	mV
--------------	-----	----

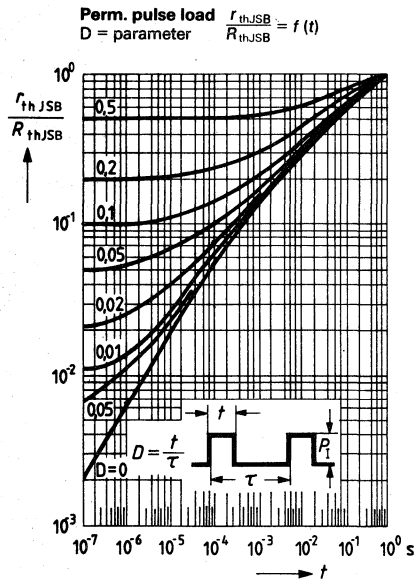
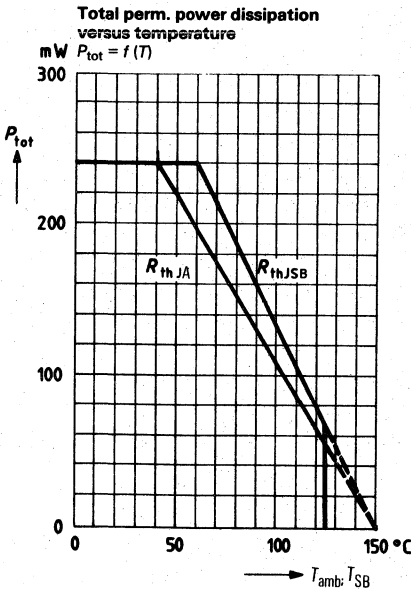

1) $V_{int 1\%}$ is the rms value of half the EMF of a 100% sine modulated TV carrier with $R_g = 75\ \Omega$, which causes 1% AM on the useful carrier.

BF 599 is an epitaxial NPN silicon planar transistor in TO 236 plastic package (23 A 3 DIN 41 869). The transistor is outstanding for its low reverse transfer capacitance and is particularly suitable for use in uncontrolled VHF amplifier stages in common emitter configurations for film circuits. The transistor is marked by the code letters "NB".

Type	Mark	Ordering code
BF 599	NB	Q62702-F550

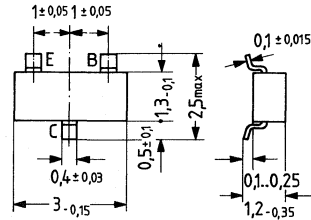

Approx. weight 0.02 g Dimensions in mm

Maximum ratings

Collector-emitter voltage	V_{CEO}	25	V
Collector-base voltage	V_{CBO}	40	V
Base-emitter voltage	V_{EBO}	4	V
Collector current	I_C	25	mA
Base current	I_B	2	mA
Junction temperature	T_j	125	°C
Storage temperature range	T_{stg}	-55 to +125	°C
Total power dissipation ($T_{SB} = 65^\circ\text{C}$)	P_{tot}	150	mW

V_{CEO}	25	V
V_{CBO}	40	V
V_{EBO}	4	V
I_C	25	mA
I_B	2	mA
T_j	125	°C
T_{stg}	-55 to +125	°C
P_{tot}	150	mW

Thermal resistance

Junction to ambient air	R_{thJA}	< 500	K/W
Junction to substrate back ¹⁾	R_{thJSB}	< 400	K/W

R_{thJA}	< 500	K/W
R_{thJSB}	< 400	K/W

1) Ceramic substrate 0.7 mm; 2.5 cm² area

Static characteristics ($T_{amb} = 25^{\circ}\text{C}$)

Collector cutoff current

($V_{CB} = 40\text{ V}$)

DC current gain

($V_{CE} = 10\text{ V}; I_C = 7\text{ mA}$)

Base-emitter voltage

($V_{CE} = 10\text{ V}; I_C = 7\text{ mA}$)

I_{CBO}	< 100	nA
h_{FE}	85 (> 38)	—
V_{BE}	0.78	V

Dynamic characteristics ($T_{amb} = 25^{\circ}\text{C}$)

Transition frequency

($V_{CE} = 10\text{ V}; I_C = 5\text{ mA}; f = 100\text{ MHz}$)

Reverse transfer capacitance

($V_{CE} = 10\text{ V}; I_C = 1\text{ mA}; f = 1\text{ MHz}$)

Obtainable power gain

($V_{CE} = 10\text{ V}; I_C = 7\text{ mA}; f = 35\text{ MHz}$)

Small signal short circuit forward transfer admittance

($I_C = 7\text{ mA}, V_{CE} = 10\text{ V}; f = 35\text{ MHz}$)

f_T	550	MHz
$-C_{12e}$	0.35	pF
$G_{pe\ opt}^1)$	43	dB
$ Y_{21e} $	200	mS

Total perm. power dissipation versus temperature

$P_{tot} = f(T)$

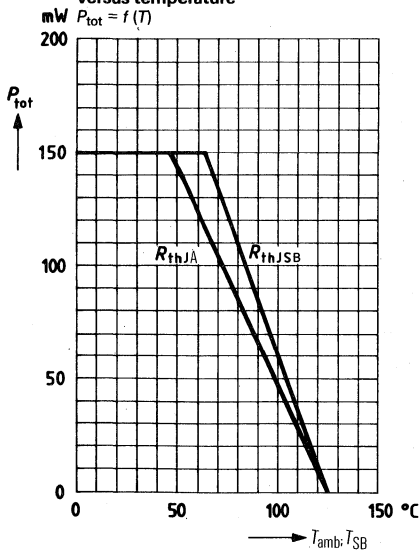

Perm. pulse load $\frac{r_{thJSB}}{R_{thJSB}} = f(t)$

D = parameter

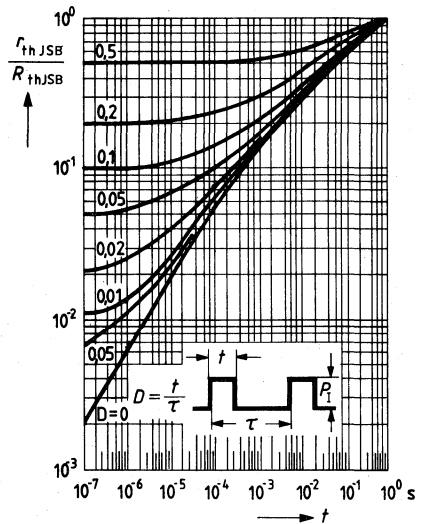

1) $G_{pe\ opt} = \frac{|Y_{21e}|^2}{4g_{11e} \cdot g_{22}}$

BF 606 A is an epitaxial PNP silicon planar transistor in TO 92 plastic package (10 A 3 DIN 41868). The transistor is intended for use in VHF oscillator stages, and in particular for the driving of MOS mixer stages.

Type	Ordering code
BF 606 A	Q62702-F535

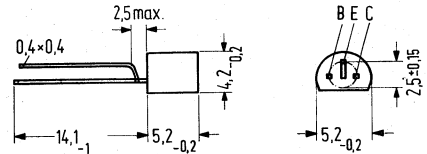

Approx. weight 0.25 g Dimensions in mm

Maximum ratings ($T_{amb} = 25\text{ }^{\circ}\text{C}$)

Collector-emitter voltage	$-V_{CE0}$	30	V
Collector-base voltage	$-V_{CBO}$	40	V
Emitter-base voltage	$-V_{EBO}$	4	V
Collector current	$-I_C$	25	mA
Emitter current	$-I_E$	30	mA
Junction temperature	T_j	150	$^{\circ}\text{C}$
Storage temperature range	T_{stg}	-55 to +150	$^{\circ}\text{C}$
Total power dissipation ($T_{amb} = 45\text{ }^{\circ}\text{C}$)	P_{tot}	300	mW

$-V_{CE0}$	30	V
$-V_{CBO}$	40	V
$-V_{EBO}$	4	V
$-I_C$	25	mA
$-I_E$	30	mA
T_j	150	$^{\circ}\text{C}$
T_{stg}	-55 to +150	$^{\circ}\text{C}$
P_{tot}	300	mW

Thermal resistance

Junction to ambient air	R_{thJA}	≤ 350	K/W
-------------------------	------------	------------	-----

Static characteristics ($T_{amb} = 25^{\circ}\text{C}$)

Collector cutoff current ($-V_{CBO} = 20\text{ V}$)	$-I_{CBO}$	< 60	nA
Collector-emitter breakdown voltage ($-I_C = 2\text{ mA}$)	$-V_{(BR)CEO}$	> 30	V
Collector-base breakdown voltage ($-I_C = 10\ \mu\text{A}$)	$-V_{(BR)CBO}$	> 40	V
Emitter-base breakdown voltage ($-I_E = 10\ \mu\text{A}$)	$-V_{(BR)EBO}$	> 4	V
DC current gain ($-I_C = 1\text{ mA}; -V_{CE} = 10\text{ V}$)	h_{FE}	> 30	-

Dynamic characteristics ($T_{amb} = 25^{\circ}\text{C}$)

Transition frequency ($-I_C = 5\text{ mA}; -V_{CE} = 10\text{ V}; f = 100\text{ MHz}$)	f_T	650	MHz
Reverse transfer capacitance ($-V_{CE} = 10\text{ V}; f = 1\text{ MHz}$)	$-C_{12b}$	0.35	pF
Reverse transfer capacitance ($-V_{CE} = 10\text{ V}; -I_C = 1\text{ mA}; f = 1\text{ MHz}$)	$-C_{12e}$	< 0.85	pF

BF 622 is an epitaxial NPN silicon planar transistor in SOT 89 plastic package as complementary type to BF 623.

It is particularly suitable for video B output stages in thin and thick film circuits. The transistor is marked with the code letters "DA".

Type	Mark	Ordering code
BF 622	DA	Q62702-F568

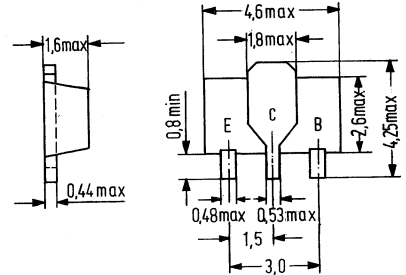

Approx. weight 0.1 g Dimensions in mm

Maximum ratings ($T_{amb} = 25^\circ\text{C}$)

Collector-base voltage	V_{CBO}	250	V
Collector-emitter voltage	V_{CEO}	250	V
Emitter-base voltage	V_{EBO}	5	V
Collector current	I_C	20	mA
Collector peak current	I_{CM}	100	mA
Junction temperature	T_j	150	$^\circ\text{C}$
Storage temperature range	T_{stg}	-65 to +150	$^\circ\text{C}$
Total power dissipation ($T_{SB} = 60^\circ\text{C}$) ¹⁾	P_{tot}	2	W

V_{CBO}	250	V
V_{CEO}	250	V
V_{EBO}	5	V
I_C	20	mA
I_{CM}	100	mA
T_j	150	$^\circ\text{C}$
T_{stg}	-65 to +150	$^\circ\text{C}$
P_{tot}	2	W

Thermal resistance

Junction to substrate back
(Ceramic substrate 0.7 mm; 2.5 cm² area)

R_{thJSB}	45	K/W
-------------	----	-----

¹⁾ T_{SB} = temperature of the substrate back below the transistor. In case of cementing the substrate on a heat sink, T_{SB} equals the heat sink temperature.

Static characteristics ($T_{amb} = 25^{\circ}\text{C}$)

Collector-base breakdown voltage
 Collector-emitter breakdown voltage
 Emitter-base breakdown voltage
 Collector cutoff current
 ($V_{CB} = 200\text{ V}$)
 Collector cutoff current
 ($R_{BE} = 10\text{ k}\Omega, V_{CE} = 200\text{ V}; T_j = 150^{\circ}\text{C}$)
 Emitter cutoff current
 ($V_{EB} = 5\text{ V}$)
 Collector-emitter saturation voltage
 ($I_C = 25\text{ mA}; T_j = 150^{\circ}\text{C}$)
 DC current gain
 ($I_C = 25\text{ mA}; V_{CE} = 20\text{ V}$)

$V_{(BR)CBO}$	> 250	V
$V_{(BR)CEO}$	> 250	V
$V_{(BR)EBO}$	> 5	V
I_{CBO}	< 100	nA
I_{CER}	< 50	μA
I_{EBO}	< 10	μA
$V_{CEsatRF}$	20	V
h_{FE}	> 50	-

Dynamic characteristics ($T_{amb} = 25^{\circ}\text{C}$)

Transition frequency
 ($V_{CE} = 10\text{ V}; I_C = 10\text{ mA}$)
 Reverse transfer capacitance
 ($V_{CB} = 30\text{ V}$)
 Feedback time constant
 ($V_{CB} = 20\text{ V}; -I_E = 10\text{ mA}; f = 10.7\text{ MHz}$)

f_T	> 60	MHz
$-C_{12e}$	< 1.6	pF
$r_{bb'} C_{bb'}$	< 70	ps

Total perm. power dissipation versus temperature

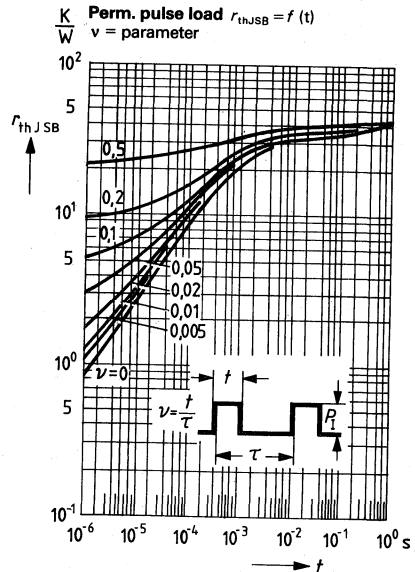
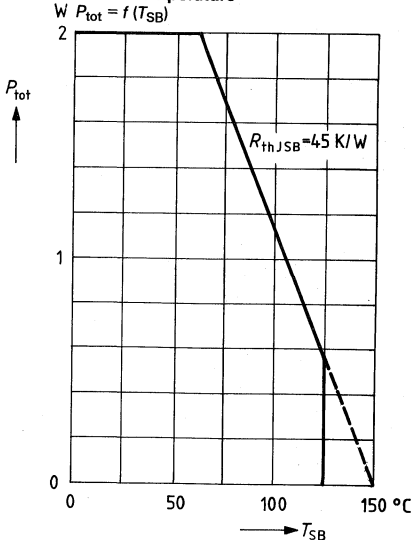

BF 623 is an epitaxial PNP silicon planar transistor in SOT 89 plastic package and is the complementary type to BF 622.

It is particularly suitable for video B output stages in thin and thick film circuits. The transistor is marked with the code letters "DB".

Type	Mark	Ordering code
BF 623	DB	Q62702-F567

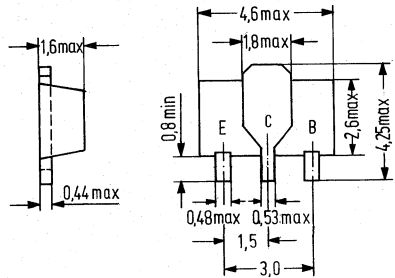

Approx. weight 0.1 g Dimensions in mm

Maximum ratings ($T_{amb} = 25^{\circ}\text{C}$)

Collector-base voltage	$-V_{CBO}$	250	V
Collector-emitter voltage	$-V_{CEO}$	250	V
Emitter-base voltage	$-V_{EBO}$	5	V
Collector current	$-I_C$	20	mA
Collector peak current	$-I_{CM}$	100	mA
Junction temperature	T_j	150	$^{\circ}\text{C}$
Storage temperature range	T_{stg}	-65 to +150	$^{\circ}\text{C}$
Total power dissipation ($T_{SB} = 60^{\circ}\text{C}$) ¹⁾	P_{tot}	2	W

Thermal resistance

Junction to substrate back (Ceramic substrate 0.7 mm; 2.5 cm ² area)	R_{thJSB}	45	K/W
--	-------------	----	-----

1) T_{SB} = temperature of the substrate back below the transistor. In case of cementing the substrate on a heat sink, T_{SB} equals the heat sink temperature.

Static characteristics ($T_{amb} = 25^{\circ}\text{C}$)

Collector-base breakdown voltage
 Collector-emitter breakdown voltage
 Emitter-base breakdown voltage
 Collector cutoff current
 ($-V_{CB} = 200\text{ V}$)
 Collector cutoff current
 ($R_{BE} = 10\text{ k}\Omega, -V_{CE} = 200\text{ V}; T_j = 150^{\circ}\text{C}$)
 Emitter cutoff current
 ($-V_{BE} = 5\text{ V}$)
 Collector-emitter saturation voltage
 ($-I_C = 25\text{ mA}; T_j = 150^{\circ}\text{C}$)
 DC current gain
 ($-I_C = 25\text{ mA}; -V_{CE} = 20\text{ V}$)

$-V_{(BR)CBO}$	> 250	V
$-V_{(BR)CEO}$	> 250	V
$-V_{(BR)EBO}$	> 5	V
$-I_{CBO}$	< 100	nA
$-I_{CER}$	< 50	μA
$-I_{EBO}$	< 10	μA
$-V_{CEsatRF}$	20	V
h_{FE}	> 50	-

Dynamic characteristics ($T_{amb} = 25^{\circ}\text{C}$)

Transition frequency
 ($-V_{CE} = 10\text{ V}; -I_C = 10\text{ mA}$)
 Reverse transfer capacitance
 ($-V_{CB} = 30\text{ V}$)
 Feedback time constant
 ($-V_{CB} = 20\text{ V}; I_E = 10\text{ mA}; f = 10.7\text{ MHz}$)

f_T	> 60	MHz
$-C_{12e}$	< 1.6	pF
$r_{bb'} \cdot C_{bb'}$	< 70	ps

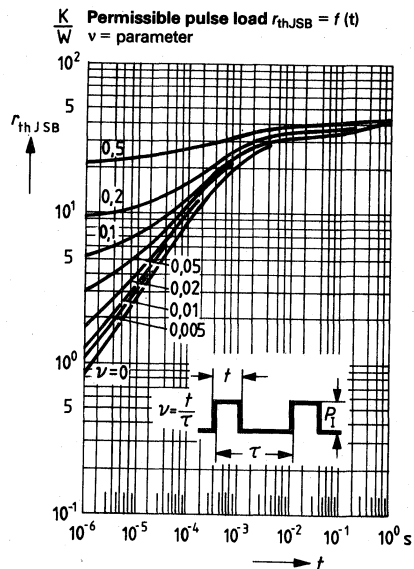
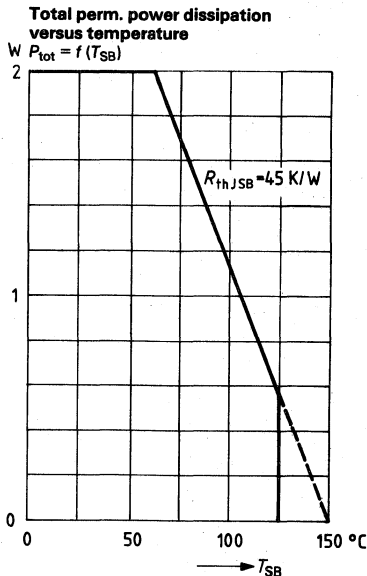

BF 660 is an epitaxial PNP silicon planar transistor in TO 236 plastic package (23 A 3 DIN 41869). The transistor is intended for use in VHF oscillator stages and in particular for driving MOS FET mixer stages as well as for uncontrolled VHF amplifier stages in film circuits. The transistor is marked on its package with the code letters "LE".

Type	Mark	Ordering code
BF 660	LE	Q62702-F549

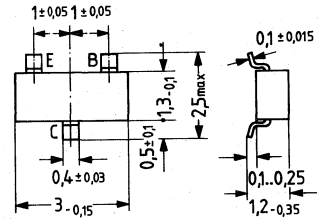

Approx. weight 0.02 g Dimensions in mm

Maximum ratings

Collector-emitter voltage	$-V_{CE0}$	30	V
Collector-base voltage	$-V_{CBO}$	40	V
Emitter-base voltage	$-V_{EBO}$	4	V
Collector current	$-I_C$	25	mA
Emitter current	$-I_E$	30	mA
Junction temperature	T_j	125	°C
Storage temperature range	T_{stg}	-55 to +125	°C
Total power dissipation ($T_{SB} = 65^\circ\text{C}$)	P_{tot}	150	mW

			V
			V
			V
			mA
			mA
			°C
			°C
			mW

Thermal resistance

Junction to ambient air	R_{thJA}	< 500	K/W
Junction to substrate back ¹⁾	R_{thJSB}	< 400	K/W

			K/W
			K/W

1) Ceramic substrate 0.7 mm; 2.5 cm² area

Static characteristics ($T_{amb} = 25^{\circ}\text{C}$)

Collector-base breakdown voltage

($-I_C = 10 \mu\text{A}$)

Collector-emitter breakdown voltage

($-I_C = 2 \text{ mA}$)

Emitter-base breakdown voltage

($-I_E = 10 \mu\text{A}$)

Collector cutoff current

($-V_{CB} = 20 \text{ V}$)

DC current gain

($-I_C = 3 \text{ mA}$; $-V_{CE} = 10 \text{ V}$)

$-V_{(BR)CBO}$	> 40	V
$-V_{(BR)CEO}$	> 30	V
$-V_{(BR)EBO}$	> 4	V
$-I_{CBO}$	< 50	nA
h_{FE}	> 30	-

Dynamic characteristics ($T_{amb} = 25^{\circ}\text{C}$)

Transition frequency

($-I_C = 5 \text{ mA}$; $-V_{CE} = 10 \text{ V}$; $f = 100 \text{ MHz}$)

Reverse transfer capacitance

($-V_{CE} = 10 \text{ V}$; $-I_C = 1 \text{ mA}$; $f = 1 \text{ MHz}$)

f_T	650	MHz
$-C_{12e}$	0.65	pF

Total perm. power dissipation versus temperature

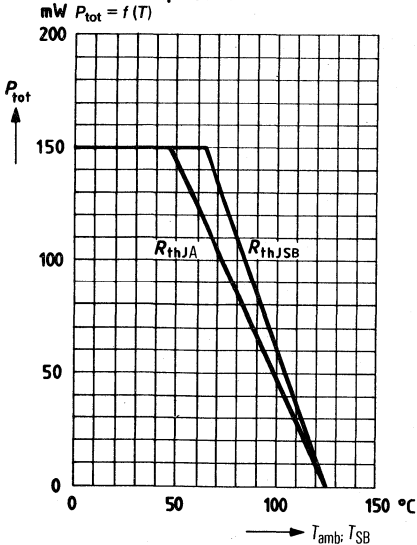

Permissible pulse load $\frac{r_{thJSB}}{R_{thJSB}} = f(t)$
D= parameter

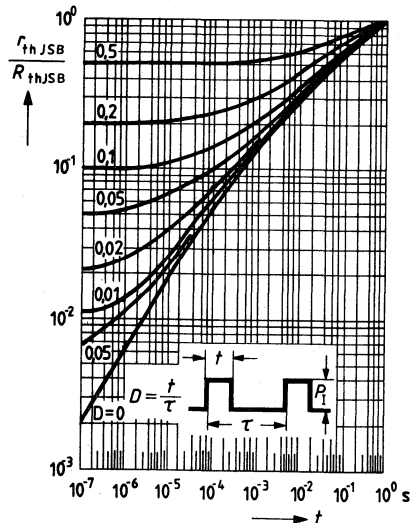

BF 767 is a PNP silicon planar transistor including passivated surface in TO 236 plastic package (23 A 3 DIN 41869). The transistor is particularly suitable for use in low-noise, gain-controlled VHF and UHF input stages for film circuits. The transistor is marked on its package with the code letters "LG".

Type	Mark	Ordering code
BF 767	LG	Q62702-F553

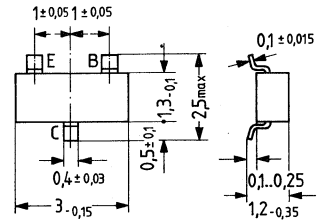

Approx. weight 0.02 g Dimensions in mm

Maximum ratings

Collector-emitter voltage	$-V_{CEO}$	30	V
Collector-base voltage	$-V_{CBO}$	30	V
Emitter-base voltage	$-V_{EBO}$	3	V
Collector current	$-I_C$	20	mA
Base current	$-I_B$	5	mA
Junction temperature	T_j	125	°C
Storage temperature range	T_{stg}	-55 to +125	°C
Total power dissipation ($T_{SB} = 65^\circ\text{C}$)	P_{tot}	200	mW

$-V_{CEO}$	30	V
$-V_{CBO}$	30	V
$-V_{EBO}$	3	V
$-I_C$	20	mA
$-I_B$	5	mA
T_j	125	°C
T_{stg}	-55 to +125	°C
P_{tot}	200	mW

Thermal resistance

Junction to ambient air	R_{thJA}	<500	K/W
Junction to substrate back ¹⁾	R_{thJSB}	<400	K/W

R_{thJA}	<500	K/W
R_{thJSB}	<400	K/W

1) Ceramic substrate 0.7 mm; 2.5 cm² area

Static characteristics ($T_{amb} = 25^{\circ}\text{C}$)

Collector cutoff current ($-V_{CBO} = 15\text{ V}$)
 DC current gain ($-V_{CE} = 10\text{ V}; -I_C = 3\text{ mA}$)
 Emitter cutoff current ($-I_C = 0; -V_{EB} = 3\text{ V}$)

$-I_{CBO}$	<100	nA
h_{FE}	60 (>15)	-
$-I_{EBO}$	<10	μA

Dynamic characteristics ($T_{amb} = 25^{\circ}\text{C}$)

Transition frequency
 ($-I_C = 3\text{ mA}; -V_{CE} = 10\text{ V}; f = 100\text{ MHz}$)
 Collector-base capacitance
 ($-V_{CB} = 10\text{ V}; f = 1\text{ MHz}$)
 Power gain
 ($-I_C = 3\text{ mA}; -V_{CB} = 10\text{ V}; f = 800\text{ MHz}$,
 $R_L = 500\ \Omega$)
 Collector current¹⁾
 ($f = 800\text{ MHz}, V_{CC} = 12\text{ V}, R_C = 1\text{ k}\Omega$
 $R_g = 60\ \Omega, R_L = 500\ \Omega$)
 Noise figure ($-I_C = 3\text{ mA}; -V_{CB} = 10\text{ V}; R_g = 60\ \Omega$
 $f = 800\text{ MHz}$)
 ($f = 200\text{ MHz}$)

f_T	950	MHz
C_{CBO}	0.32	pF
G_{pb}	13	dB
I_C	7	mA
NF	3.7	dB
NF	2.9	dB

for 30 dB regulation to minor values

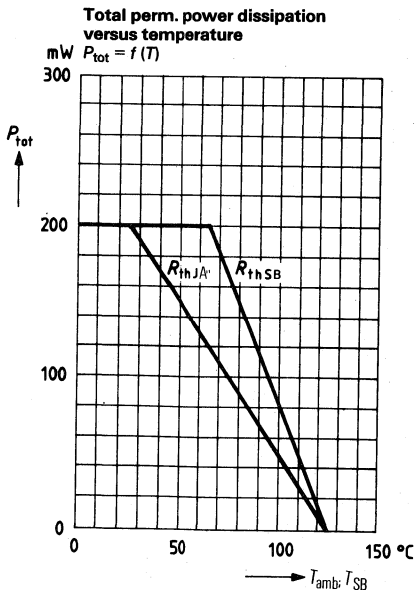

for video and AF output stages

BF 847, BF 848, and BF 849 are epitaxial PNP silicon planar transistors in plastic package similar to TO 202. The collector is conductively connected to the metallic mounting area of the transistor. The transistors are especially designed for use in video output stages of TV receivers, for AF output stages of high operating voltage and as driver transistors in horizontal deflection circuits.

Type	Ordering code
BF 847	Q62702-F662
BF 848	Q62702-F663
BF 849	Q62702-F664

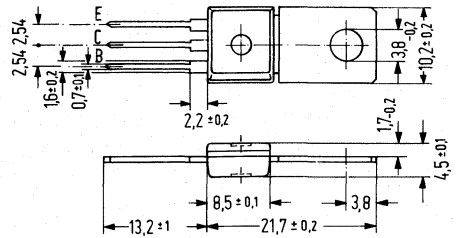

Approx. weight 15 g Dimensions in mm

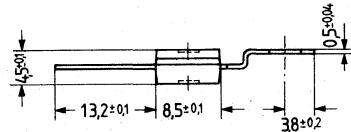

Available upon request also with bent fixing plate.

Maximum ratings

	BF 847	BF 848	BF 849		
Collector-base voltage	-V _{CB0}	160	270	300	V
Collector-emitter voltage	-V _{CE0}	160	250	300	V
Emitter-base voltage	-V _{EBO}	5	5	5	V
Collector current	-I _C	100	100	100	mA
Base current	-I _B	50	50	50	mA
Collector peak current	-I _{CM}	300	300	300	mA
Junction temperature	T _j	150	150	150	°C
Storage temperature range	T _{stg}		-55 to +150		°C
Total power dissipation (T _{amb} ≤ 25 °C)	P _{tot}	1.8	1.8	1.8	W
(T _{case} ≤ 100 °C)	P _{tot}	2.5	2.5	2.5	W

Thermal resistance

Junction to ambient air	R _{thJA}	≤ 70	≤ 70	≤ 70	K/W
Junction to case	R _{thJC}	≤ 20	≤ 20	≤ 20	K/W

Static characteristics ($T_{amb} = 25^{\circ}\text{C}$)		BF 847	BF 848	BF 849	
Collector-base breakdown voltage ($I_C = 100 \mu\text{A}$)	$-V_{(BR)CBO}$	< 160	< 250	< 300	V
Collector-emitter breakdown voltage ($I_C = 10 \text{ mA}$)	$-V_{(BR)CEO}$	< 160	< 250	< 300	V
Emitter-base breakdown voltage ($I_C = 100 \mu\text{A}$)	$-V_{(BR)EBO}$	> 5	> 5	> 5	V
Collector cutoff current ($V_{CB} = 100 \text{ V}$)	$-I_{CBO}$	< 50	–	–	nA
($V_{CB} = 200 \text{ V}$)	$-I_{CBO}$	–	< 50	–	nA
($V_{CB} = 250 \text{ V}$)	$-I_{CBO}$	–	–	< 50	nA
Emitter cutoff current ($V_{EBO} = 3 \text{ V}$)	$-I_{EBO}$	< 50	< 50	< 50	nA
Collector-emitter saturation voltage ($I_C = 30 \text{ mA}$; $I_B = 6 \text{ mA}$)	$-V_{CEsat}$	< 1	< 1	< 1	V
DC current gain ($I_C = 30 \text{ mA}$; $V_{CE} = 10 \text{ V}$)	h_{FE}	> 25	> 25	> 25	–

Dynamic characteristics ($T_{amb} = 25^{\circ}\text{C}$)					
Transition frequency ($V_{CE} = 10 \text{ V}$; $I_C = 15 \text{ mA}$; $f = 20 \text{ MHz}$)	f_T	90	90	90	MHz
Reverse transfer capacitance ($V_{CE} = 30 \text{ V}$; $f = 1 \text{ MHz}$; $I_C = 1 \text{ mA}$)	$-C_{12e}$	4.2	4.2	4.2	pF
Output capacitance ($V_{CB} = 30 \text{ V}$; $f = 1 \text{ MHz}$; $I_E = 0$)	C_{22e}	5.5	5.5	5.5	pF

Total perm. power dissipation versus temperature

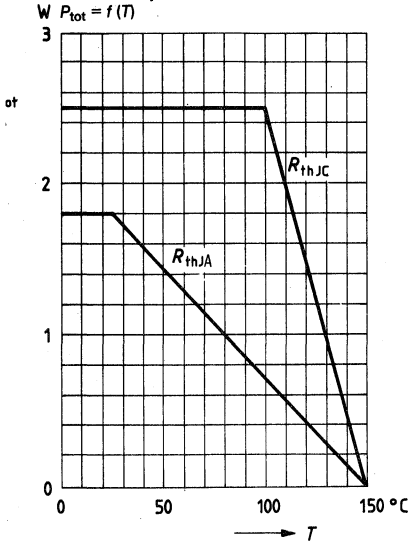

Permissible operating range

$I_C = f(V_{CE}); T_{case} = 100^\circ\text{C}; D = 0$

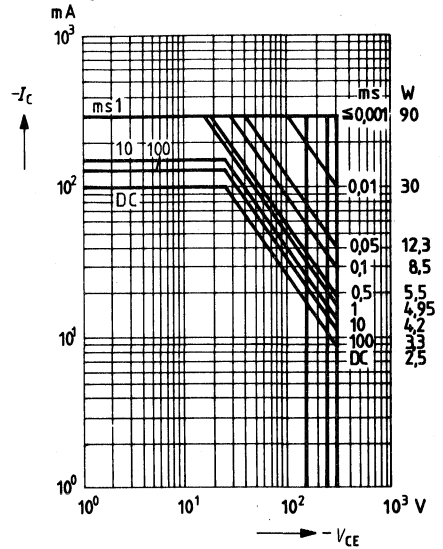

Permissible pulse load

$\frac{Z_{thJC}}{R_{thJC}} = f(\tau)$

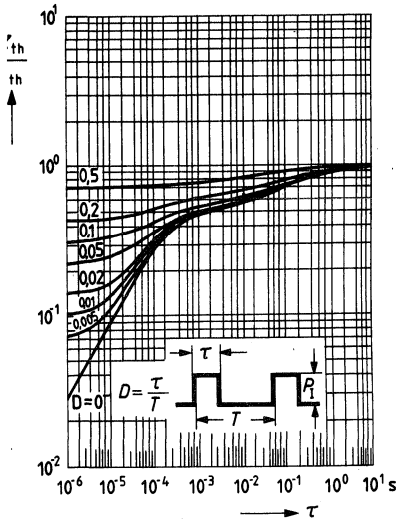

Characteristic curves for:

Collector current $I_C = f(V_{BE})$

Output characteristics $I_C = f(V_{CE})$

Base current $I_B = f(I_C)$ and

Transition frequency $f_T = f(I_C)$

similar to those of BF 857, 858, 859

for video and AF output stages

BF 857, BF 858, and BF 859 are epitaxial NPN silicon planar transistors in a plastic package similar to TO 202. The collector is conductively connected to the metallic mounting area of the transistor. The transistors are especially designed for use in video output stages of TV receivers, for AF output stages of high operating voltage, and as driver transistors in horizontal deflection circuits.

Type	Ordering code
BF 857	Q62702-F623
BF 858	Q62702-F624
BF 859	Q62702-F625

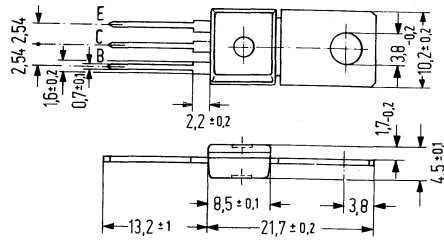

Approx. weight 15 g Dimensions in mm

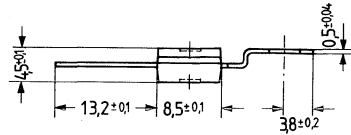

Available upon request also with bent fixing plate.

Maximum ratings

		BF 857	BF 858	BF 859	
Collector-base voltage	V_{CBO}	160	270	300	V
Collector-emitter voltage	V_{CEO}	160	250	300	V
Emitter-base voltage	V_{EBO}	5	5	5	V
Collector current	I_C	100	100	100	mA
Base current	I_B	50	50	50	mA
Collector peak current	I_{CM}	300	300	300	mA
Junction temperature	T_j	150	150	150	°C
Storage temperature range	T_{stg}	-55 to +150			°C
Total power dissipation ($T_{amb} \leq 25^\circ\text{C}$)	P_{tot}	1.8	1.8	1.8	W
($T_{case} \leq 100^\circ\text{C}$)	P_{tot}	2.5	2.5	2.5	W

Thermal resistance

Junction to ambient air	R_{thJA}	≤ 70	≤ 70	≤ 70	K/W
Junction to case	R_{thJC}	≤ 20	≤ 20	≤ 20	K/W

Static characteristics ($T_{amb} = 25^{\circ}\text{C}$)		BF 857	BF 858	BF 859	
Collector-base breakdown voltage ($I_C = 100 \mu\text{A}$)	$V_{(BR)CBO}$	< 160	< 250	< 300	V
Collector-emitter breakdown voltage ($I_C = 10 \text{ mA}$)	$V_{(BR)CEO}$	< 160	< 250	< 300	V
Emitter-base breakdown voltage ($I_E = 100 \mu\text{A}$)	$V_{(BR)EBO}$	> 5	> 5	> 5	V
Collector cutoff current ($V_{CB} = 100 \text{ V}$)	I_{CBO}	< 50	–	–	nA
($V_{CB} = 200 \text{ V}$)	I_{CBO}	–	< 50	–	nA
($V_{CB} = 250 \text{ V}$)	I_{CBO}	–	–	< 50	nA
Emitter cutoff current ($V_{EBO} = 3 \text{ V}$)	I_{EBO}	< 50	< 50	< 50	nA
Collector-emitter saturation voltage ($I_C = 30 \text{ mA}$; $I_B = 6 \text{ mA}$)	V_{CEsat}	< 1	< 1	< 1	V
DC current gain ($I_C = 30 \text{ mA}$; $V_{CE} = 10 \text{ V}$)	h_{FE}	> 25	> 25	> 25	–

Dynamic characteristics ($T_{amb} = 25^{\circ}\text{C}$)

Transition frequency ($V_{CE} = 10 \text{ V}$; $I_C = 15 \text{ mA}$; $f = 20 \text{ MHz}$)	f_T	90	90	90	MHz
Reverse transfer capacitance ($V_{CE} = 30 \text{ V}$; $f = 1 \text{ MHz}$; $I_C = 1 \text{ mA}$)	$-C_{12e}$	4.2	4.2	4.2	pF
Output capacitance ($V_{CB} = 30 \text{ V}$; $f = 1 \text{ MHz}$; $I_E = 0$)	C_{22e}	5.5	5.5	5.5	pF

Total perm. power dissipation versus temperature
 $P_{tot} = f(T)$

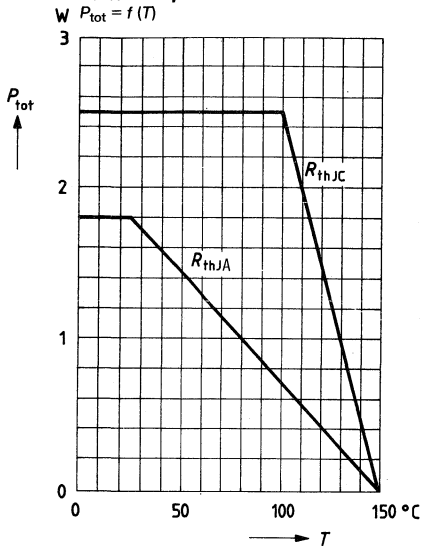

Permissible operating range
 $I_C = f(V_{CE}); T_{case} = 100^\circ\text{C}; D = 0$

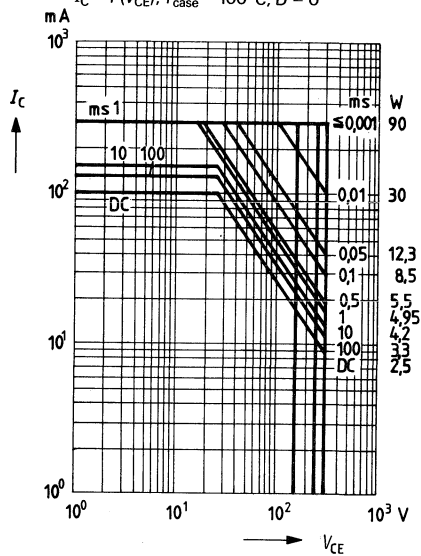

Permissible pulse load

$\frac{Z_{thJC}}{R_{thJC}} = f(\tau)$

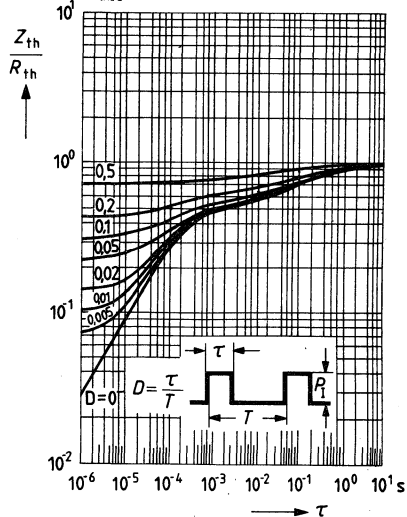

Collector current $I_C = f(V_{BE})$
 $V_{CE} = 10\text{ V}; T_{case} = \text{parameter}$

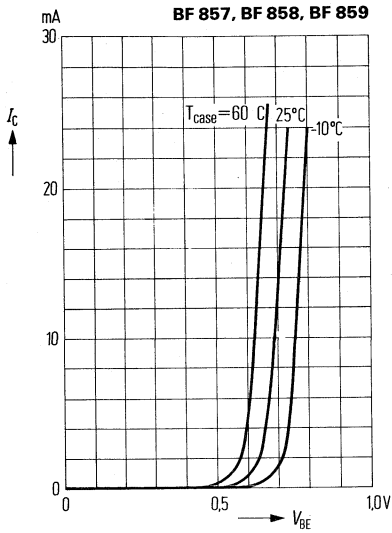

Output characteristics $I_C = f(V_{CE})$
 $I_B = \text{parameter}$

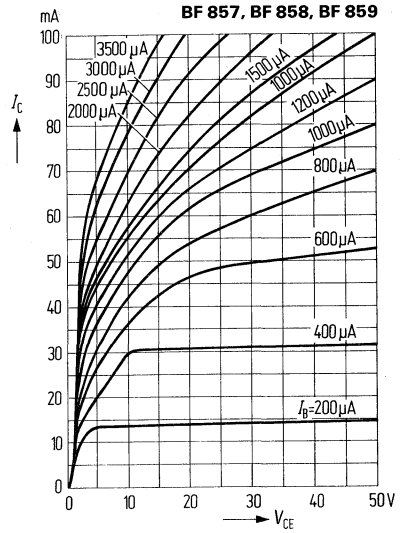

Base current $I_B = f(I_C)$
 $V_{CE} = 10\text{ V}; T_{case} = \text{parameter}$

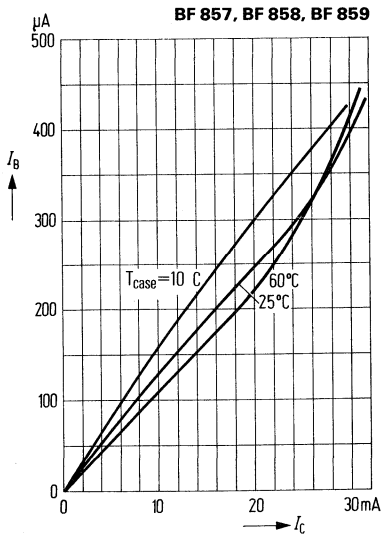

Transition frequency $f_T = f(I_C)$
 $V_{CE} = 10\text{ V}; f = 20\text{ MHz}$

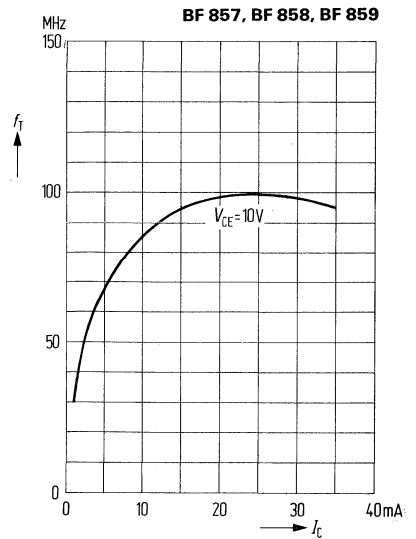

BF 869 and BF 871 are epitaxial NPN silicon planar transistors in a plastic package similar to TO 202.

The collector is conductively connected to the metallic mounting area of the transistor. The transistor are especially designed for use in video B output stages of TV receivers and for AF output stages of high operating voltage.

Complementary types for BF 869: BF 870 and for BF 871: BF 872.

Type	Ordering code
BF 869	Q62702-F592
BF 871	Q62702-F593

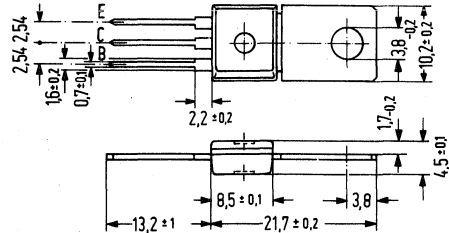

Approx. weight 15 g Dimensions in mm

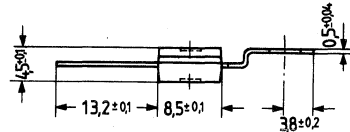

Available upon request also with bent fixing plate.

Maximum ratings ($T_{amb} = 25^\circ\text{C}$)

Collector-base voltage	V_{CBO}	250	300	V
Collector-emitter voltage	V_{CEO}	250	-	V
Collector-emitter voltage	V_{CER}	-	300	V
Emitter-base voltage	V_{EBO}	5	5	V
Collector current	I_C	30	30	mA
Collector peak current	I_{CM}	100	100	mA
Junction temperature	T_j	150	150	$^\circ\text{C}$
Storage temperature range	T_{stg}	-65 to +150	-65 to +150	$^\circ\text{C}$
Total power dissipation ($T_{case} \leq 110^\circ\text{C}$)	P_{tot}	1.6	1.6	W
Total power dissipation ($T_{amb} \leq 25^\circ\text{C}$)	P_{tot}	1.6	1.6	W

Thermal resistance

Junction to ambient air ¹⁾	R_{thJA}	≤ 70	≤ 70	K/W
Junction to case	R_{thJC}	≤ 25	≤ 25	K/W

1) For fixing the transistors with max. 4 mm long leads on PCBs with a 10 mm² large copper area for the collector terminal.

Static characteristics ($T_{amb} = 25^{\circ}\text{C}$)

Collector-base breakdown voltage
 Collector-emitter breakdown voltage
 Collector-emitter breakdown voltage
 ($R_{BE} = 2.7\text{ k}\Omega$)
 Emitter-base breakdown voltage
 Collector cutoff current
 ($V_{CBO} = 200\text{ V}$)
 Collector cutoff current
 ($R_{BE} = 2.7\text{ k}\Omega$, $V_{CE} = 200\text{ V}$, $T_j = 150^{\circ}\text{C}$)
 Emitter cutoff current ($V_{EBO} = 5\text{ V}$)
 Collector-emitter saturation voltage
 ($I_C = 25\text{ mA}$; $T_j = 150^{\circ}\text{C}$)
 DC current gain ($I_C = 25\text{ mA}$; $V_{CE} = 20\text{ V}$)

	BF 869	BF 871	
$V_{(BR)CBO}$	> 250	> 300	V
$V_{(BR)CEO}$	> 250	-	V
$V_{(BR)CER}$	-	300	V
$V_{(BR)EBO}$	> 5	> 5	V
I_{CBO}	≤ 10	≤ 10	nA
I_{CER}	≤ 10	≤ 10	μA
I_{EBO}	≤ 10	≤ 10	μA
$V_{CEsat\text{ RF}}$	20	20	V
h_{FE}	≥ 50	≥ 40	-

Dynamic characteristics ($T_{amb} = 25^{\circ}\text{C}$)

Transition frequency ($V_{CE} = 10\text{ V}$; $I_C = 10\text{ mA}$)
 Reverse transfer capacitance ($V_{CB} = 30\text{ V}$)
 Feedback time constant
 ($V_{CB} = 20\text{ V}$; $-I_E = 10\text{ mA}$; $f = 10.7\text{ MHz}$)

f_T	≥ 60	≥ 60	MHz
$-C_{12e}$	≤ 2	≤ 2	pF
$r_{bb'}\text{ } c_{b'c}$	≤ 90	≤ 90	ps

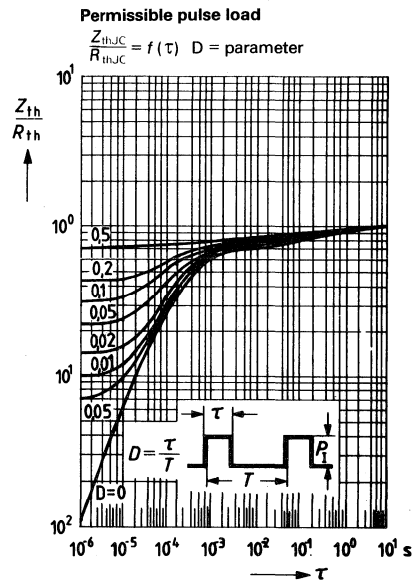
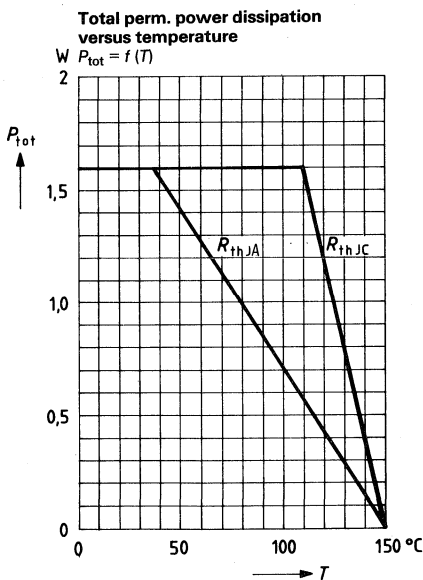

Permissible operating range $I_C = f(V_{CE})$
 $T_{case} \leq 110^\circ\text{C}$, $d = 0.01$

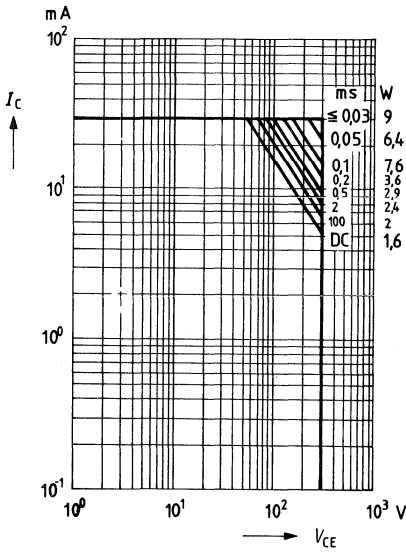

DC current gain $h_{FE} = f(I_C)$
 $V_{CE} = 10\text{ V}$; $T_{case} = 25^\circ\text{C}$

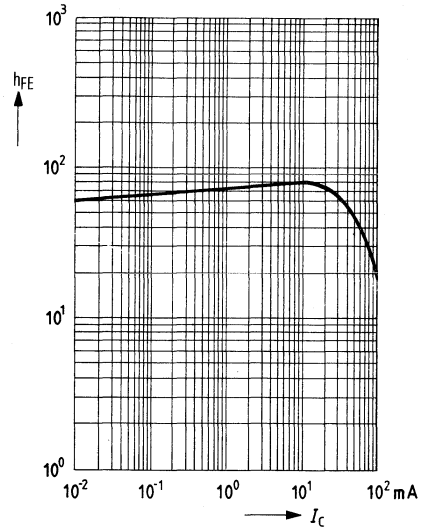

Collector current $I_C = f(V_{BE})$
 $V_{CE} = 10\text{ V}$; $T_{case} = 25^\circ\text{C}$

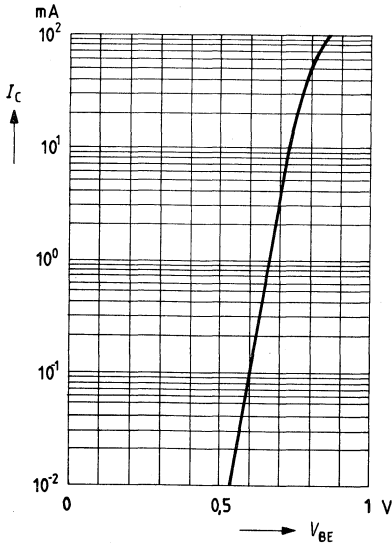

Transition frequency $f_T = f(I_C)$
 $V_{CE} = 10\text{ V}$; $T_{case} = 25^\circ\text{C}$

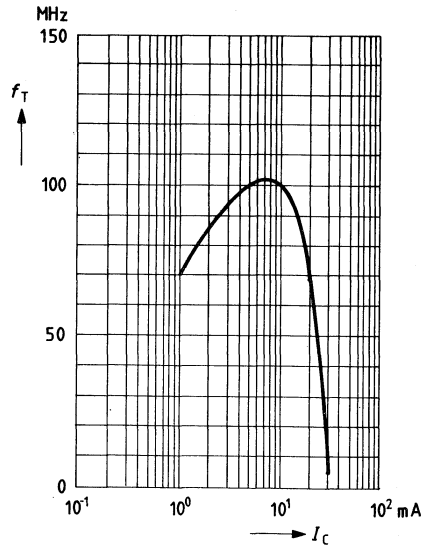

BF 870 and BF 872 are epitaxial PNP silicon planar transistors in a plastic package similar to TO 202.

The collector is conductively connected to the metallic mounting area of the transistor. The transistor are especially designed for use in video output stages of TV receivers and for AF output stages of high operating voltage.

Complementary types for BF 870: BF 869 and for BF 872: BF 871.

Type	Ordering code
BF 870	Q62702-F602
BF 872	Q62702-F603

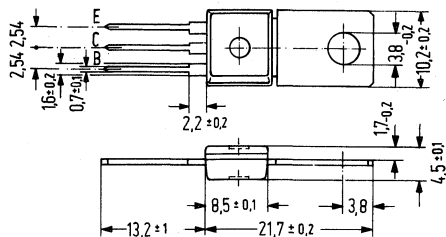

Approx. weight 15 g Dimensions in mm

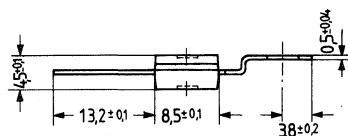

Available upon request also with bent fixing plate

Maximum ratings ($T_{amb} = 25^\circ\text{C}$)

	BF 870	BF 872	
Collector-base voltage	$-V_{CBO}$ 250	300	V
Collector-emitter voltage	$-V_{CEO}$ 250	-	V
Collector-emitter voltage	$-V_{CER}$ -	300	V
Emitter-base voltage	$-V_{EBO}$ 5	5	V
Collector current	$-I_C$ 30	30	mA
Collector peak current	$-I_{CM}$ 100	100	mA
Junction temperature	T_j 150	150	$^\circ\text{C}$
Storage temperature range	T_{stg} -65 to +150	-65 to +150	$^\circ\text{C}$
Total power dissipation ($T_{case} \leq 110^\circ\text{C}$)	P_{tot} 1.6	1.6	W
Total power dissipation ($T_{amb} \leq 25^\circ\text{C}$)	P_{tot} 1.6	1.6	W

Thermal resistance

Junction to ambient air ¹⁾	R_{thJA}	≤ 70	≤ 70	K/W
Junction to case	R_{thJC}	≤ 25	≤ 25	K/W

1) For fixing the transistors with max. 4 mm long leads on PCBs with a 10 mm² large copper area for the collector terminal.

Static characteristics ($T_{amb} = 25^\circ\text{C}$)

Collector-base breakdown voltage
 Collector-emitter breakdown voltage
 Collector-emitter breakdown voltage
 ($R_{BE} = 2.7\text{ k}\Omega$)
 Emitter-base breakdown voltage
 Collector cutoff current ($-V_{CBO} = 200\text{ V}$)
 Collector cutoff current
 ($R_{BE} = 2.7\text{ k}\Omega, -V_{CE} = 200\text{ V}, T_j = 150^\circ\text{C}$)
 Emitter cutoff current ($-V_{EBO} = 5\text{ V}$)
 Collector-emitter saturation voltage
 ($-I_C = 25\text{ mA}, T_j = 150^\circ\text{C}$)
 DC current gain ($-I_C = 25\text{ mA}; -V_{CE} = 20\text{ V}$)

	BF 870	BF 872	
$-V_{(BR)CBO}$	> 250	> 300	V
$-V_{(BR)CEO}$	> 250	-	V
$V_{(BR)CER}$	-	300	V
$-V_{(BR)EBO}$	> 5	> 5	V
$-I_{CBO}$	≤ 10	≤ 10	nA
$-I_{CER}$	≤ 10	≤ 10	μA
$-I_{EBO}$	≤ 10	≤ 10	μA
$-V_{CEsat\text{ RF}}$	20	20	V
h_{FE}	≥ 50	≥ 40	-

Dynamic characteristics ($T_{amb} = 25^\circ\text{C}$)

Transition frequency
 ($-V_{CE} = 10\text{ V}; -I_C = 10\text{ mA}$)
 Reverse transfer capacitance ($-V_{CB} = 30\text{ V}$)
 Feedback time constant
 ($-V_{CB} = 20\text{ V}; I_E = 10\text{ mA}; f = 10.7\text{ MHz}$)

f_T	≥ 60	≥ 60	MHz
$-C_{12e}$	≤ 2	≤ 2	pF
$r_{bb'}\text{ } C_{b'c}$	≤ 90	≤ 90	ps

Total perm. power dissipation versus temperature

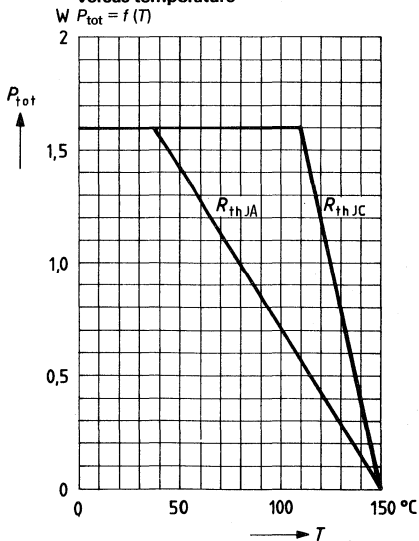

Permissible pulse load

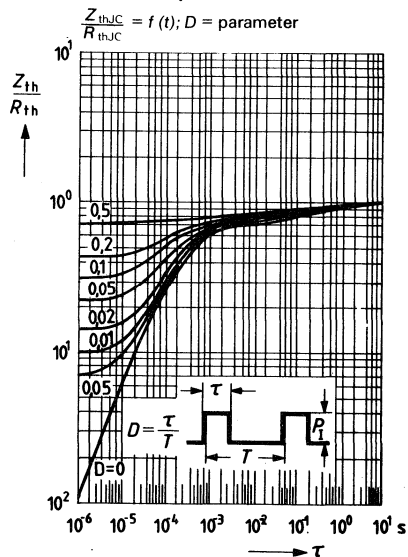

Permissible operating range
 $I_C = f(V_{CE}); T_{case} = \leq 110^\circ\text{C}; D = 0.01$

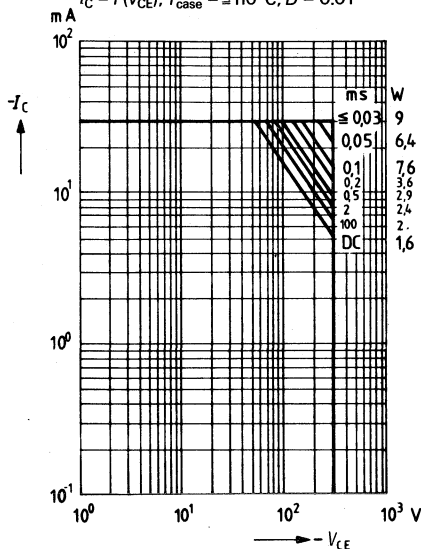

DC current gain $h_{FE} = f(I_C)$
 $-V_{CE} = 10 \text{ V}; T_{case} = 25^\circ\text{C}$

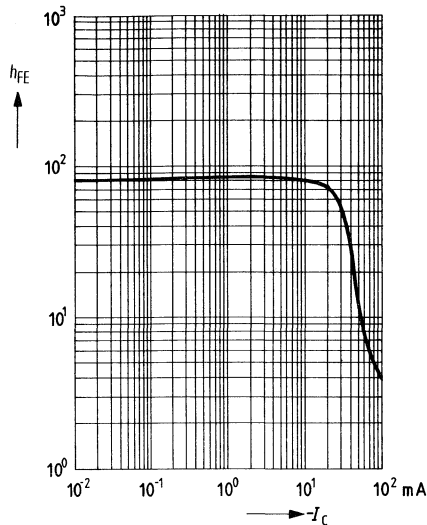

Collector current $I_C = f(V_{BE})$
 $-V_{CE} = 10 \text{ V}; T_{case} = 25^\circ\text{C}$

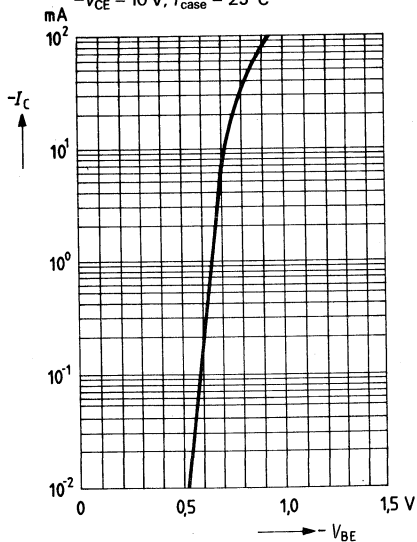

Transition frequency $f_T = f(I_C)$
 $-V_{CE} = 10 \text{ V}; T_{case} = 25^\circ\text{C}$

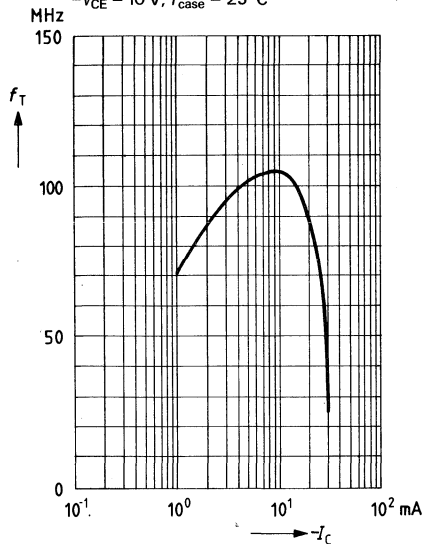

BF 926 is an epitaxial PNP silicon planar transistor in TO 92 plastic package (10 A 3 DIN 41868). The transistor is intended for use in VHF oscillator stages, in particular for driving MOS mixer stages.

Type	Ordering code
BF 926	Q62702-F 678

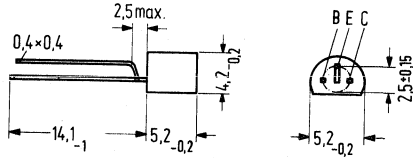

Approx. weight 0.25 g

Dimensions in mm

Maximum ratings

Collector-emitter voltage	$-V_{CEO}$	30	V
Collector-base voltage	$-V_{CBO}$	40	V
Emitter-base voltage	$-V_{EBO}$	4	V
Collector current	$-I_C$	25	mA
Emitter current	$-I_E$	30	mA
Junction temperature	T_j	150	°C
Storage temperature range	T_{stg}	-55 to +150	°C
Total power dissipation ($T_{amb} = 45\text{°C}$)	P_{tot}	300	mW

Thermal resistance

Junction to ambient air	R_{thJA}	< 350	K/W
-------------------------	------------	-------	-----

Static characteristics ($T_{amb} = 25^{\circ}\text{C}$)

Collector cutoff current ($-V_{CB} = 20\text{ V}$)	$-I_{CBO}$	< 60	nA
Collector-emitter breakdown voltage ($-I_C = 2\text{ mA}$)	$-V_{CEO}$	> 30	V
Collector-base breakdown voltage ($-I_C = 10\text{ }\mu\text{A}$)	$-V_{CBO}$	> 40	V
Emitter-base breakdown voltage ($-I_E = 10\text{ }\mu\text{A}$)	$-V_{EBO}$	> 4	V
DC current gain ($-I_C = 1\text{ mA}$; $-V_{CE} = 10\text{ V}$)	h_{FE}	80 (> 30)	-

Dynamic characteristics ($T_{amb} = 25^{\circ}\text{C}$)

Transition frequency ($-I_C = 5\text{ mA}$; $-V_{CE} = 10\text{ V}$; $f = 100\text{ MHz}$)	f_T	600	MHz
Reverse transfer capacitance ($-V_{CB} = 10\text{ V}$; $-I_C = 5\text{ mA}$; $f = 1\text{ MHz}$)	$-C_{12e}$	0.6	pF
Output capacitance ($-I_E = 0$; $-V_{CB} = 10\text{ V}$; $f = 1\text{ MHz}$)	C_{OB}	0.8	pF
Input capacitance ($-V_{EBO} = 0.15\text{ V}$; $NF = 1\text{ MHz}$)	C_{EBO}	2	pF

BF 939 is a PNP silicon RF planar transistor in TO 92 plastic package (DIN 41868). The transistor is particularly suitable for controllable VHF input stages in TV tuners.

Type	Ordering code
BF 939	Q62702-F 528

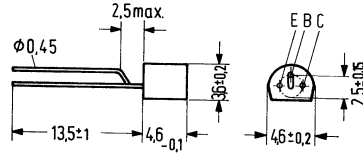

Approx. weight 0.25 g Dimensions in mm

Maximum ratings

Collector-emitter voltage	$-V_{CEO}$	30	V
Collector-base voltage	$-V_{CBO}$	30	V
Base-emitter voltage	$-V_{EBO}$	3	V
Collector current	$-I_C$	20	mA
Base current	$-I_B$	2	mA
Storage temperature range	T_{stg}	-55 to +150	$^{\circ}C$
Junction temperature	T_j	150	$^{\circ}C$
Total power dissipation ($T_{amb} = 60^{\circ}C$)	P_{tot}	350	mW

Thermal resistance

Junction to ambient air	R_{thJA}	<500	K/W
-------------------------	------------	------	-----

Static characteristics ($T_{amb} = 25^{\circ}\text{C}$)($-V_{CE} = 20\text{ V}$; $-V_{BE} = 0$)

$-I_{CES}$	< 100	nA
------------	-------	----

DC current gain($-I_C = 2\text{ mA}$; $-V_{CE} = 10\text{ V}$)($-I_C = 7\text{ mA}$; $-V_{CE} = 5\text{ V}$)

h_{FE}	50 (> 30)	-
h_{FE}	(> 10)	-

Dynamic characteristics ($T_{amb} = 25^{\circ}\text{C}$)**Transition frequency**($-I_C = 2\text{ mA}$; $-V_{CE} = 10\text{ V}$; $f = 100\text{ MHz}$)

f_T	750	MHz
-------	-----	-----

Reverse transfer capacitance($-I_C = 1\text{ mA}$; $-V_{CE} = 10\text{ V}$)

C_{12e}	0.63	pF
-----------	------	----

Noise figure($-I_C = 2\text{ mA}$; $-V_{CE} = 10\text{ V}$; $f = 200\text{ MHz}$; $R_g = 60\ \Omega$)

NF	3	dB
----	---	----

Power gain($-I_C = 2\text{ mA}$; $-V_{CE} = 10\text{ V}$; $f = 200\text{ MHz}$; $R_L = 1\text{ k}\Omega$; $R_g = 60\ \Omega$)

G_{pb}	16	dB
----------	----	----

Control range of power gain($-V_{CC} = 12\text{ V}$; $R_{CC} = 1\text{ k}\Omega$; $f = 200\text{ MHz}$; $I_C \leq 9\text{ mA}$)

G_{pb}	> 35	dB
----------	------	----

Min. interference voltage¹⁾($f = 200\text{ MHz}$; $-I_C = 2\text{ mA}$)

$V_{int\ 1\%}$	12	mV
----------------	----	----

1) $V_{int\ 1\%}$ is the rms value of half the EMF of a 100% sine modulated TV carrier with $R_g = 75\ \Omega$, which causes 1% AM on the useful carrier.

BF 959 is an NPN silicon planar transistor in TO 92 plastic package (10 A 3 DIN 41868). The transistor is particularly suitable for use as IF input amplifier in connection with an surface acoustic wave filter as well as for general applications in linear amplifier stages throughout the VHF range with high signal levels.

Type	Ordering code
BF 959	Q62702-F 640

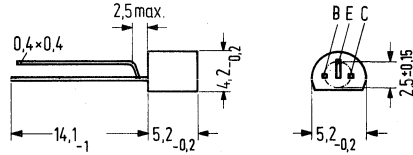

Approx. weight 0.25 g

Dimensions in mm

Maximum ratings

Collector-emitter voltage	V_{CEO}	20	V
Collector-emitter voltage	V_{CES}	30	V
Collector-base voltage	V_{CBO}	30	V
Base-emitter voltage	V_{EBO}	3	V
Collector peak current	I_{CM}	100	mA
Base peak current	I_{BM}	30	mA
Junction temperature	T_j	150	°C
Storage temperature range	T_{stg}	-55 to +150	°C
Total power dissipation ($T_{amb} \leq 25^\circ\text{C}$, $V_{CE} \leq 15\text{ V}$)	P_{tot}	500	mW

Thermal resistance

Junction to ambient air	R_{thJA}	≤ 250	K/W
-------------------------	------------	------------	-----

Static characteristics ($T_{amb} = 25^\circ\text{C}$)

Collector cutoff current ($V_{CB} = 20\text{ V}$)	I_{CBO}	≤ 100	nA
Collector-emitter breakdown voltage ($I_C = 10\text{ mA}$)	$V_{(BR)ECO}$	≥ 20	V
Collector-base breakdown voltage ($I_C = 10\text{ }\mu\text{A}$)	$V_{(BR)CBO}$	≥ 30	V
Emitter-base breakdown voltage ($I_E = 10\text{ }\mu\text{A}$)	$V_{(BR)EBO}$	≥ 3	V
DC current gain ($I_C = 5\text{ mA}$; $V_{CE} = 10\text{ V}$)	h_{FE}	≥ 35	-
($I_C = 20\text{ mA}$; $V_{CE} = 10\text{ V}$)	h_{FE}	85 (>40)	-
Base-emitter forward voltage ($I_C = 20\text{ mA}$; $V_{CE} = 10\text{ V}$)	V_{BE}	0.75	V
Collector-emitter saturation voltage ($I_C = 30\text{ mA}$; $I_B = 2\text{ mA}$)	V_{CEsat}	≤ 1	V
Base-emitter saturation voltage ($I_C = 30\text{ mA}$; $I_B = 2\text{ mA}$)	V_{BEsat}	≤ 0.95	V

Dynamic characteristics ($T_{amb} = 25^\circ\text{C}$)

Small signal current gain ($I_C = 20\text{ mA}$; $V_{CE} = 10\text{ V}$)	h_{fe}	90	-
Transition frequency ($I_C = 20\text{ mA}$; $V_{CE} = 10\text{ V}$; $f = 100\text{ MHz}$)	f_T	$1100 \geq 700$	MHz
($I_C = 30\text{ mA}$; $V_{CE} = 5\text{ V}$; $f = 100\text{ MHz}$)	f_T	≥ 600	MHz
Output capacitance ($V_{CB} = 10\text{ V}$; $I_E = 0$; $f = 1\text{ MHz}$)	C_{ob}	0.9	pF
Reverse transfer capacitance ($I_C = 1\text{ mA}$; $V_{CE} = 10\text{ V}$; $f = 1\text{ MHz}$)	C_{12e}	0.8	pF
Noise figure ($I_C = 5\text{ mA}$; $V_{CE} = 10\text{ V}$; $f = 200\text{ MHz}$; $R_g = 60\text{ }\Omega$)	NF	3	dB
($I_C = 20\text{ mA}$; $V_{CE} = 10\text{ V}$; $f = 200\text{ MHz}$; $R_g = 60\text{ }\Omega$)	NF	4.5	dB
Short-circuit output admittance ($I_C = 20\text{ mA}$; $V_{CE} = 10\text{ V}$; $f = 35\text{ MHz}$)	g_{22e}	0.06	mS

Total perm. power dissipation versus temperature

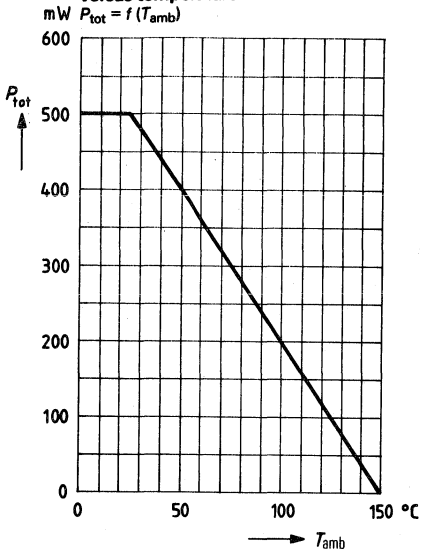

Transition frequency $f_T = f(I_C)$
 $f = 100$ MHz; $V_{CE} = \text{parameter}$

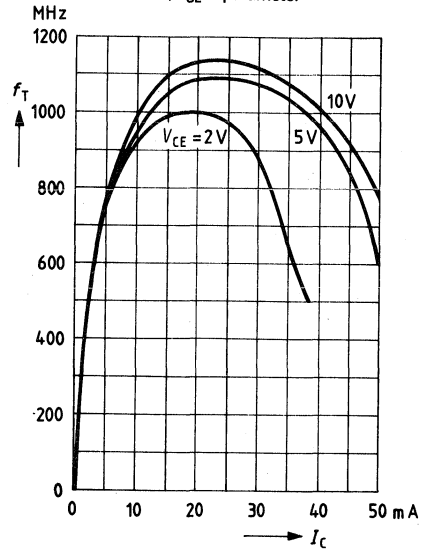

Short-circuit forward transfer admittance $|y_{21e}| = f(I_C)$, $f = 35$ MHz

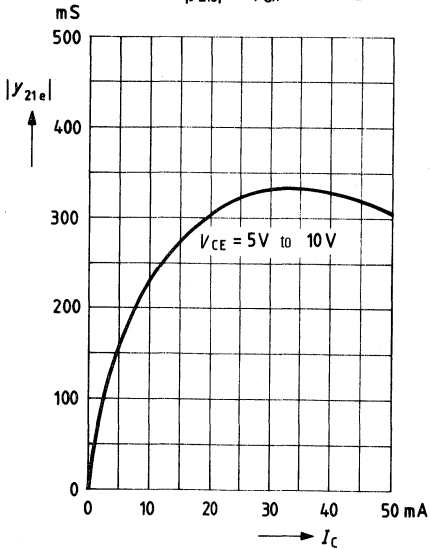

Reverse transfer capacitance $C_{12e} = f(V_{CB})$; $I_C = 1$ mA; $f = 1$ MHz

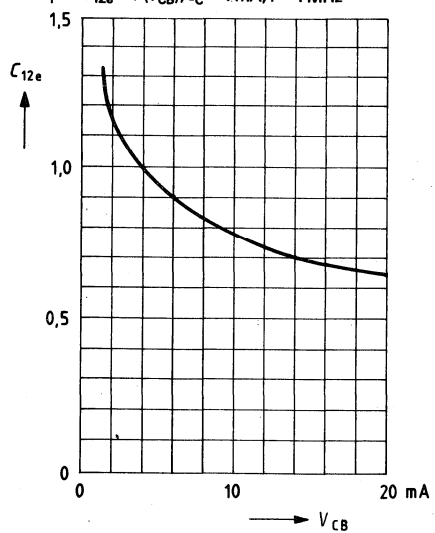

BF 960 is an ion-implanted dual gate N-channel MOS field effect transistor of the depletion type with integrated gate-protection diodes in a plastic package similar to TO 120, (50 B4 DIN 41 867). The source lead is internally connected with the substrate. The BF 960 tetrode is particularly suitable for use in TV UHF input stages and mixers as well as for universal applications throughout the frequency range between 200 MHz and 1 GHz.

Type	Ordering code
BF 960	Q62702-F499

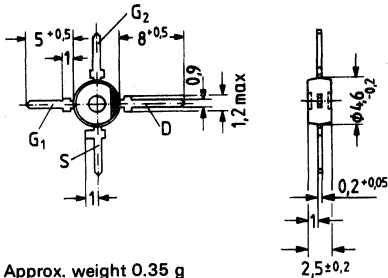

Approx. weight 0.35 g

Dimensions in mm

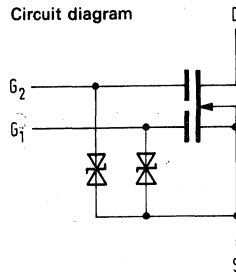

Maximum ratings

- Drain-source voltage
- Drain current
- Gate 1/gate 2-source peak current
- Storage temperature range
- Channel temperature
- Total power dissipation ($T_{amb} \leq 60^\circ\text{C}$)

V_{DS}	20	V
I_D	30	mA
$\pm I_{G1/2SM}$	10	mA
T_{stg}	-55 to +150	$^\circ\text{C}$
T_{ch}	150	$^\circ\text{C}$
P_{tot}	200	mW

Thermal resistance

- Channel to ambient

R_{thA}	≤ 450	K/W
-----------	------------	-----

Static characteristics ($T_{amb} = 25^{\circ}\text{C}$)

Drain-source breakdown voltage ($I_D = 10 \mu\text{A}$; $-V_{G1S} = -V_{G2S} = 4 \text{ V}$)	$V_{(BR)DS}$	≥ 20	V
Gate 1 source breakdown voltage ($\pm I_{G1S} = 10 \text{ mA}$; $V_{G2S} = V_{DS} = 0$)	$\pm V_{(BR)G1SS}$	6 to 20	V
Gate 2 source breakdown voltage ($\pm I_{G2S} = 10 \text{ mA}$; $V_{G1S} = V_{DS} = 0$)	$\pm V_{(BR)G2SS}$	6 to 20	V
Gate 1 leakage current ($\pm V_{G1S} = 5 \text{ V}$; $V_{G2S} = V_{DS} = 0$)	$\pm I_{G1SS}$	< 50	nA
Gate 2 leakage current ($\pm V_{G2S} = 5 \text{ V}$; $V_{G1S} = V_{DS} = 0$)	$\pm I_{G2SS}$	< 50	nA
Drain current ($V_{DS} = 15 \text{ V}$; $V_{G1S} = 0$; $V_{G2S} = 4 \text{ V}$)	I_{DSS}	2 to 20	mA
Gate 1 source pinch-off voltage ($V_{DS} = 15 \text{ V}$; $V_{G2S} = 4 \text{ V}$; $I_D = 20 \mu\text{A}$)	$-V_{G1S(p)}$	≤ 2.7	V
Gate 2 source pinch-off voltage ($V_{DS} = 15 \text{ V}$; $V_{G1S} = 0$; $I_D = 20 \mu\text{A}$)	$-V_{G2S(p)}$	≤ 2.7	V

Dynamic characteristics ($T_{amb} = 25^{\circ}\text{C}$)

Forward transadmittance

($V_{DS} = 15\text{ V}$; $I_D = 7\text{ mA}$; $V_{G2S} = 4\text{ V}$; $f = 1\text{ kHz}$)

g_{fs}	12 (9.5 to 18)	mS
----------	----------------	----

Gate 1 input capacitance

($V_{DS} = 15\text{ V}$; $I_D = 7\text{ mA}$; $V_{G2S} = 4\text{ V}$; $f = 1\text{ MHz}$)

C_{g1ss}	1.8 (1.3 to 2.3)	pF
------------	------------------	----

Gate 2 input capacitance

($V_{DS} = 15\text{ V}$; $I_D = 7\text{ mA}$; $V_{G2S} = 4\text{ V}$; $f = 1\text{ MHz}$)

C_{g2ss}	1	pF
------------	---	----

Reverse transfer capacitance *

($V_{DS} = 15\text{ V}$; $I_D = 7\text{ mA}$; $V_{G2S} = 4\text{ V}$; $f = 1\text{ MHz}$)

C_{dg1}	25 (<35)	fF
-----------	----------	----

Output capacitance

($V_{DS} = 15\text{ V}$; $I_D = 7\text{ mA}$; $V_{G2S} = 4\text{ V}$; $f = 1\text{ MHz}$)

C_{dss}	0.8 (0.65 to 1.2)	pF
-----------	-------------------	----

Power gain

($V_{DS} = 15\text{ V}$; $I_D = 7\text{ mA}$)

at $f = 200\text{ MHz}$; $G_G = 2\text{ mS}$; $G_L = 0.5\text{ mS}$

G_{ps}	23	dB
----------	----	----

at $f = 800\text{ MHz}$; $G_G = 2\text{ mS}$; $G_L = 1\text{ mS}$

G_{ps}	16.5 (13 to 20)	dB
----------	-----------------	----

Noise figure

($V_{DS} = 15\text{ V}$; $I_D = 7\text{ mA}$; $g_G = 2\text{ mS}$)

at $f = 200\text{ MHz}$

NF	1.6 (<2.8)	dB
----	------------	----

at $f = 800\text{ MHz}$

NF	2.8 (<3.9)	dB
----	------------	----

Control range

($V_{DS} = 15\text{ V}$; $V_{G2} = 4\text{ to }-2\text{ V}$; $f = 800\text{ MHz}$)

ΔG_{ps}	>40	dB
-----------------	-----	----

Mixer gain

($V_{DS} = 15\text{ V}$; $V_{G2} = 4\text{ V}$; $f = 800\text{ MHz}$;

$f_{IF} = 36\text{ MHz}$; $2\Delta f_{IF} = 5\text{ MHz}$;

$V_{osc.} = 800\text{ mV}$)

G_{psc}	16	dB
-----------	----	----

*) G_1 and S on screen potential

Total perm. power dissipation versus temperature
 $P_{tot} = f(T_{amb})$

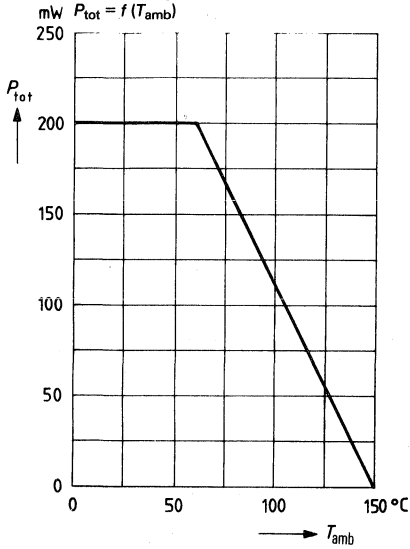

Family of output characteristics

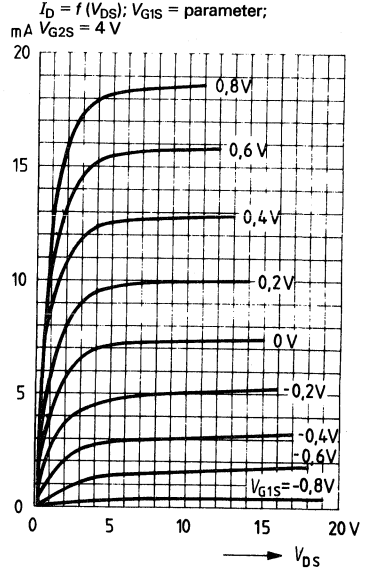

Gate 1 transadmittance $g_{fs1} = f(V_{G1S})$:

$V_{G2S} = \text{parameter}; V_{DS} = 15 \text{ V}$
 $I_{DSS} = 7 \text{ mA}; f = 1 \text{ kHz}$

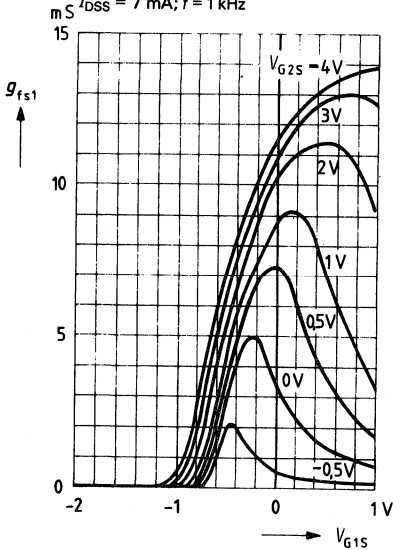

Gate 2 transadmittance $g_{fs1} = f(V_{G2S})$:

$V_{G1S} = \text{parameter}; V_{DS} = 15 \text{ V}$
 $I_{DSS} = 7 \text{ mA}; f = 1 \text{ kHz}$

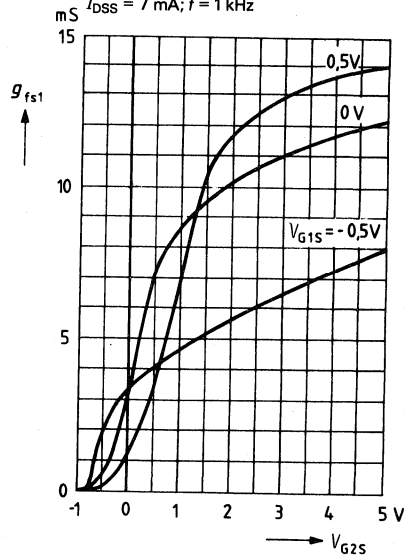

Gate 1 input capacitance

$C_{g1ss} = f(V_{G1})$; $V_{G2S} = 4\text{ V}$;
 $V_{DS} = 15\text{ V}$; $f = 1\text{ MHz}$

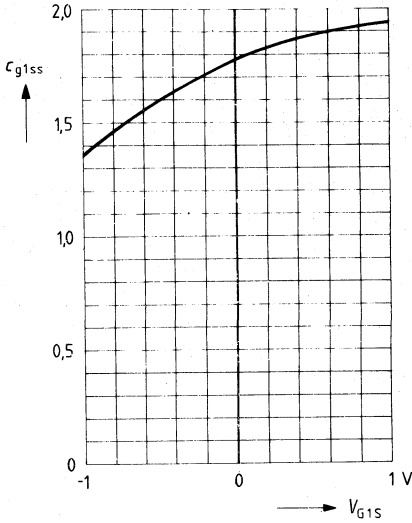

Gate 2 input capacitance

$C_{g2ss} = f(V_{G2S})$; $V_{G1S} = 0$
 $V_{DS} = 15\text{ V}$; $f = 1\text{ MHz}$

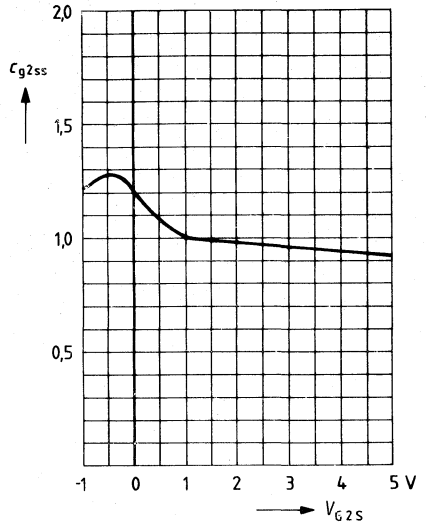

Output capacitance

$C_{dss} = f(V_{DS})$; $V_{G1S} = 0$
 $V_{G2S} = 4\text{ V}$; $f = 1\text{ MHz}$

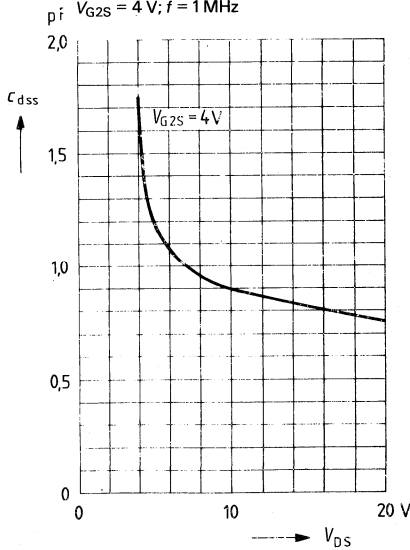

Gate 1 input conductance y_{11s}

(source circuit)
 $V_{DS} = 15\text{ V}$; $V_{G2S} = 4\text{ V}$

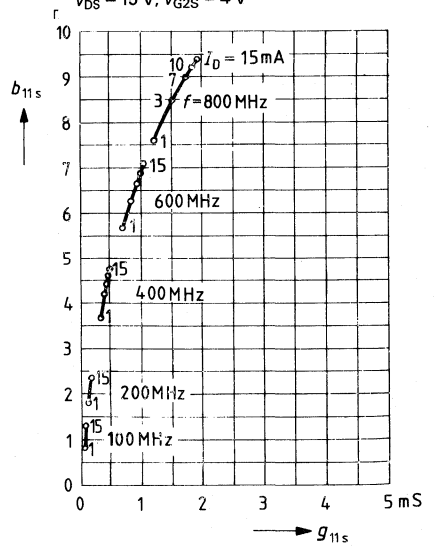

Gate 1 transadmittance Y_{21s}
(source circuit)

$V_{DS} = 15 \text{ V}; V_{G2} = 4 \text{ V}$

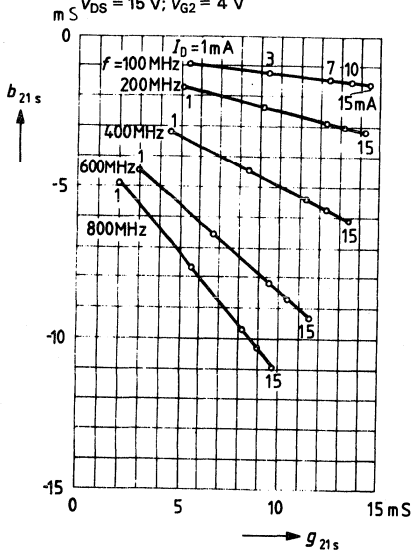

Output conductance Y_{22s}
(source circuit)

$V_{DS} = 15 \text{ V}; V_{G2} = 4 \text{ V}$

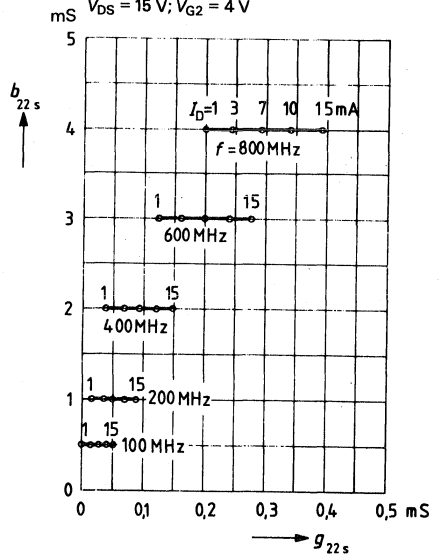

Power gain $G_{ps} = f(V_{G2s})$
 $V_{DS} = 15 \text{ V}; V_{G1s} = 0; I_{DSS} = 7 \text{ mA};$
 $f = 200 \text{ MHz}$ (see figure 1)

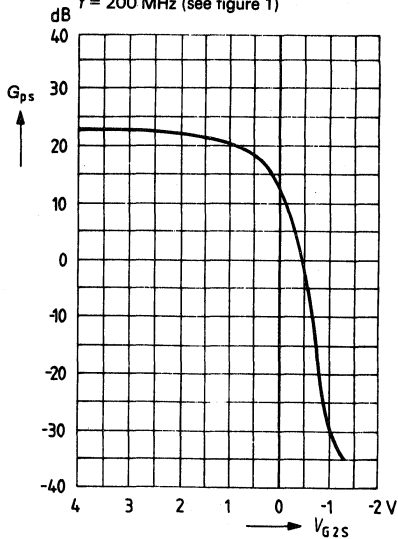

Noise figure $NF = f(V_{G2s})$
 $V_{DS} = 15 \text{ V}; V_{G1s} = 0; I_{DSS} = 7 \text{ mA};$
 $f = 200 \text{ MHz}$; (see figure 1)

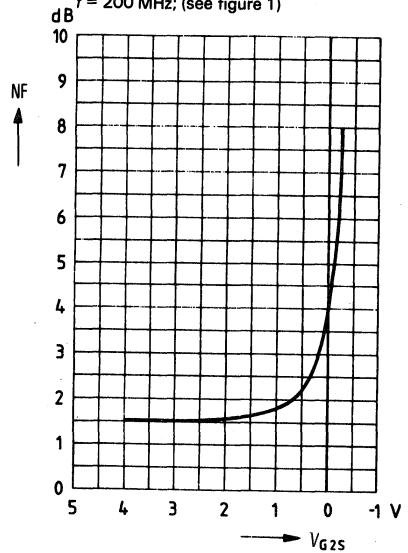

Power gain $G_{ps} = f(V_{G2S})$
 $V_{DS} = 15 \text{ V}; V_{G1S} = 0;$
 $I_{DSS} = 7 \text{ mA}; f = 800 \text{ MHz}; R_S = 0$
 (see figure 2)

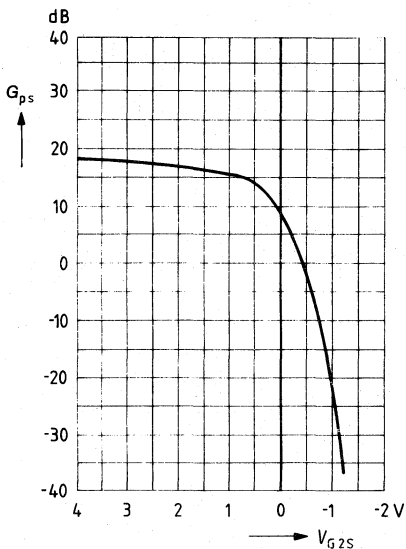

Noise figure $NF = f(V_{G2S})$
 $V_{DS} = 15 \text{ V}; V_{G1S} = 0;$
 $I_{DSS} = 7 \text{ mA}; f = 800 \text{ MHz}; R_S = 0$
 (see figure 2)

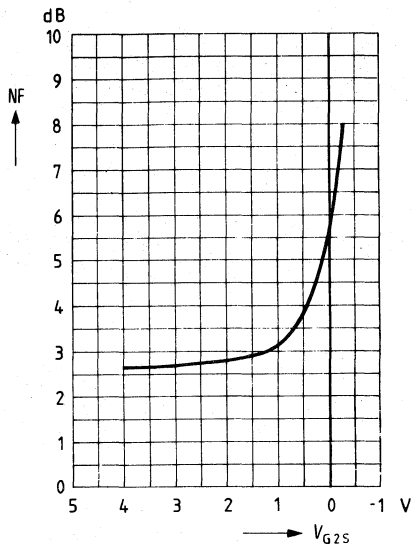

Mixer gain $G_{psc} = f(R_S)$
 $f_e = 800 \text{ MHz}; f_{osc} = 836 \text{ MHz}$
 $V_{osc} = 800 \text{ mV}; V_{DS} = 15 \text{ V}$
 $V_{G2S} = 4 \text{ V}; I_{DSS} = 7 \text{ mA}$
 (see figure 3)

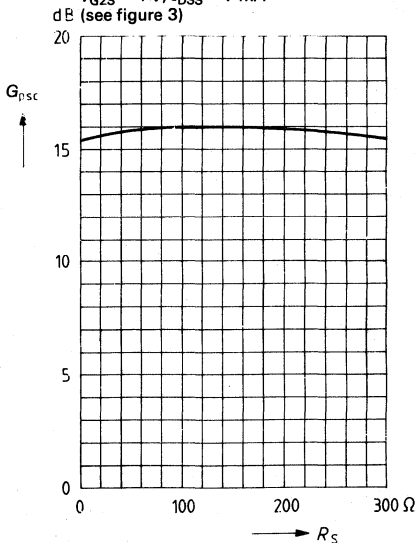

Mixer gain $G_{psc} = f(V_{osc})$
 $f_e = 800 \text{ MHz}; f_{osc} = 836 \text{ MHz}$
 $V_{DS} = 15 \text{ V}; V_{G2S} = 4 \text{ V};$
 $I_{DSS} = 7 \text{ mA}; R_S = 150 \Omega$
 (see figure 3)

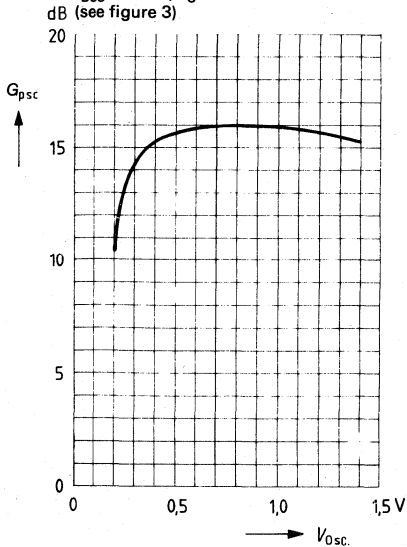

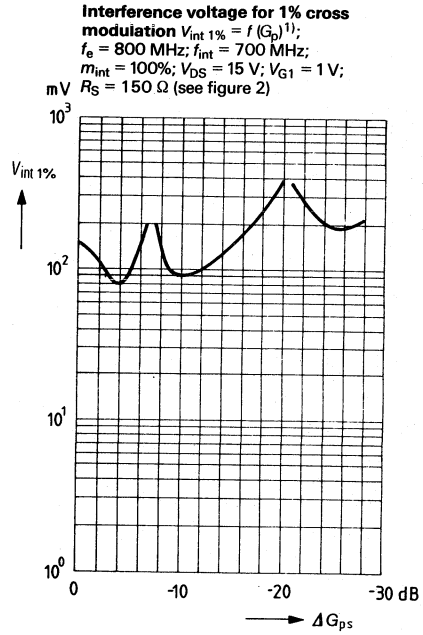
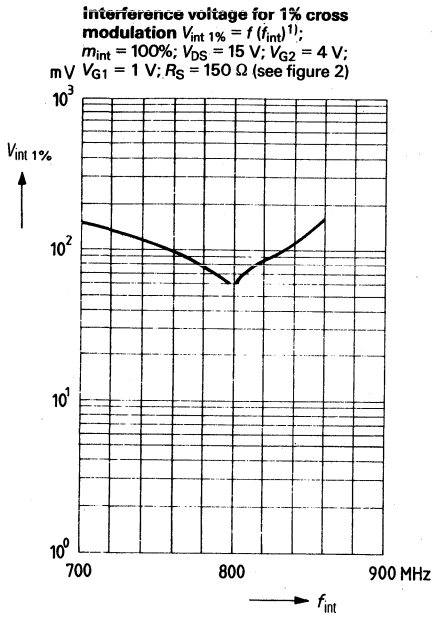

Test circuit for power gain and noise figure
 at $f = 200\text{ MHz}$ ($G_G = 2\text{ ms}$; $G_L = 0.5\text{ mS}$)

Fig. 1

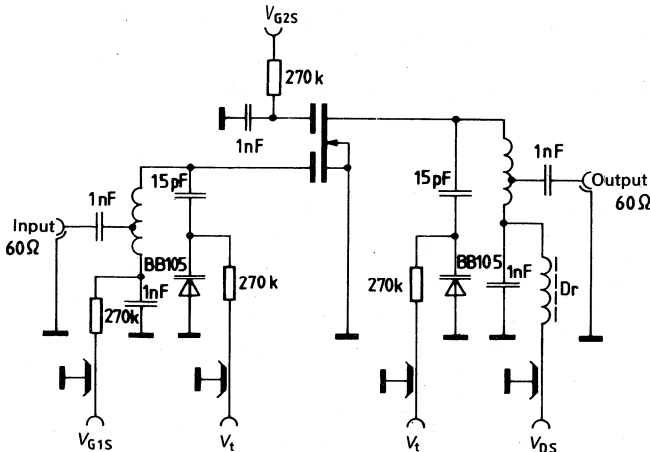

1) $V_{int\ 1\%}$ is the rms value of half the EMC (terminal voltage at matching) of a 100% sine modulated TV carrier at an internal generator resistance of $60\ \Omega$, causing 1% amplitude modulation on the active carrier.

Test circuit for power gain, noise figure and cross modulation
 $f = 800\text{ MHz}$; $G_g = 2\text{ mS}$; $G_g = 1\text{ mS}$.

Fig. 2

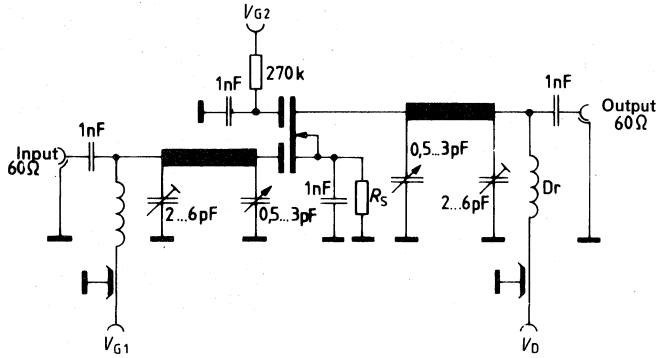

Test circuit for mixer gain $f = 800/36\text{ MHz}$.

Fig. 3

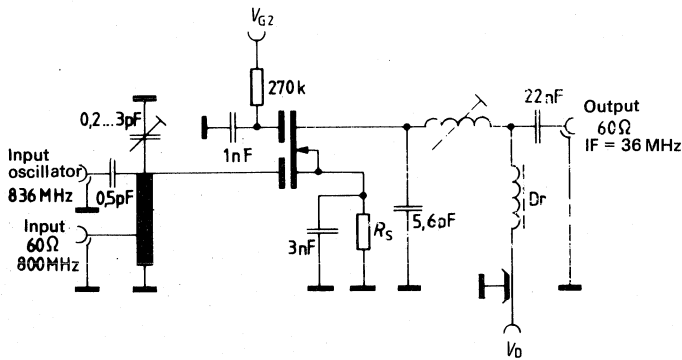

BF 961 is an ion-implanted dual gate N channel MOS field effect transistor of the depletion type with integrated gate protection diodes in a plastic package similar to TO 120 (50 B 4 DIN 41867). The source terminal is internally connected with the substrate. The tetrode is especially suitable for use in TV VHF input stages and mixers.

Type	Ordering code
BF 961	Q62702-F518

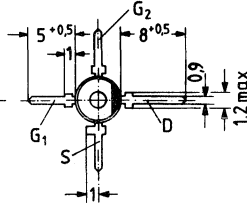

Approx. weight 0.35 g
Dimensions in mm

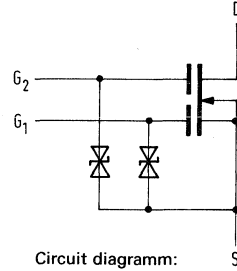
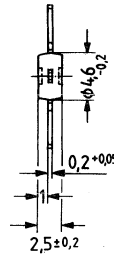

Circuit diagramm:

Maximum ratings

Drain source voltage	V_{ps}	20	V
Drain current	I_p	30	mA
Gate 1/gate 2 source peak current	$\pm I_{G1/2SM}$	10	mA
Storage temperature range	T_{stg}	-55 to +150	°C
Channel temperature	T_{ch}	150	°C
Power dissipation	P_{tot}	200	mW

Thermal resistance

Channel to ambient	R_{thA}	≤ 450	K/W
--------------------	-----------	-------	-----

Static characteristics ($T_{amb} = 25^\circ\text{C}$)

Drain-source breakdown voltage ($I_D = 10 \mu\text{A}$; $-V_{G1S} = -V_{G2S} = 4 \text{ V}$)	$V_{(BR)DS}$	≥ 20	V
Gate 1 source breakdown voltage ($\pm I_{G1S} = 10 \text{ mA}$; $V_{G2S} = V_{DS} = 0$)	$\pm V_{(BR)G1SS}$	6 to 20	V
Gate 2 source breakdown voltage ($\pm I_{G2S} = 10 \text{ mA}$; $V_{G1S} = V_{DS} = 0$)	$\pm V_{(BR)G2SS}$	6 to 20	V
Gate 1 leakage current ($\pm V_{G1S} = 5 \text{ V}$; $V_{G2S} = V_{DS} = 0$)	I_{G1SS}	≤ 50	nA
Gate 2 leakage current ($\pm V_{G2S} = 5 \text{ V}$; $V_{G1S} = V_{DS} = 0$)	I_{G2SS}	≤ 50	nA
Drain current ($V_{DS} = 15 \text{ V}$; $V_{G1S} = 0$; $V_{G2S} = 4 \text{ V}$)	I_{DSS}	4 to 20	mA
Gate 1 source pinch-off voltage ($V_{DS} = 15 \text{ V}$; $V_{G2S} = 4 \text{ V}$; $I_D = 20 \mu\text{A}$)	$-V_{G1S(p)}$	0.2 to 3.5	V
Gate 2 source pinch-off voltage ($V_{DS} = 15 \text{ V}$; $V_{G1S} = 0$; $I_D = 20 \mu\text{A}$)	$-V_{G2S(p)}$	0.2 to 3.5	V

Dynamic characteristics ($T_{amb} = 25^{\circ}\text{C}$)

Forward transadmittance

($V_{DS} = 15\text{ V}$; $I_D = 10\text{ mA}$; $V_{G2S} = 4\text{ V}$;
 $f = 1\text{ kHz}$)

g_{fs} 15 (12 to 20) mS

Gate 1 input capacitance

($V_{DS} = 15\text{ V}$; $I_D = 10\text{ mA}$; $V_{G2S} = 4\text{ V}$;
 $f = 1\text{ MHz}$)

C_{G1sS} 3.6 (3 to 4.5) pF

Gate 2 input capacitance

($V_{DS} = 15\text{ V}$; $I_D = 10\text{ mA}$; $V_{G2S} = 4\text{ V}$;
 $f = 1\text{ MHz}$)

C_{G2sS} 1.6 pF

Reverse transfer capacitance *)

($V_{DS} = 15\text{ V}$; $I_D = 10\text{ mA}$; $V_{G2S} = 4\text{ V}$;
 $f = 1\text{ MHz}$)

C_{dg1} 25 (≤ 35) fF

Output capacitance

($V_{DS} = 15\text{ V}$; $I_D = 10\text{ mA}$; $V_{G2S} = 4\text{ V}$;
 $f = 1\text{ MHz}$)

C_{dsS} 1.6 (1.2 to 2.2) pF

Power gain

($V_{DS} = 15\text{ V}$; $I_D = 10\text{ mA}$; $f = 200\text{ MHz}$;
 $2 \Delta f = 12\text{ MHz}$)

G_{ps} 23 (≥ 19) dB

Noise figure

($V_{DS} = 15\text{ V}$; $I_D = 10\text{ mA}$; $f = 200\text{ MHz}$;
 $g_G = 2\text{ mS}$; test circuit¹⁾)

NF 1.8 (≤ 2.8) dB

Control range

($V_{DS} = 15\text{ V}$; $V_{G2} = 4\text{ to } -2\text{ V}$; $f = 200\text{ MHz}$;
Test circuit 1)

ΔG_{ps} 50 dB

Mixer gain (additive)

($V_D = 15\text{ V}$; $V_{G2} = 6\text{ V}$, $R_S = 220\ \Omega$;
 $f = 200\text{ MHz}$; $f_{IF} = 36\text{ MHz}$;
 $2 \Delta f_{IF} = 5\text{ MHz}$; $V_{OSC} = 0.5\text{ V}$;
Test circuit 2)

G_{psC} 16 dB

Mixer gain (multiplicative)

($V_D = 15\text{ V}$; $V_{G1} = 1.7\text{ V}$, $V_{G2} = 2.5\text{ V}$;
 $R_S = 220\ \Omega$; $f = 200\text{ MHz}$; $f_{IF} = 36\text{ MHz}$;
 $2 \Delta f_{IF} = 5\text{ MHz}$; $V_{OSC} = 2\text{ V}$;
Test circuit 3)

G_{FSC} 18 dB

*) G_2 S on screen potential

Total perm. power dissipation versus temperature

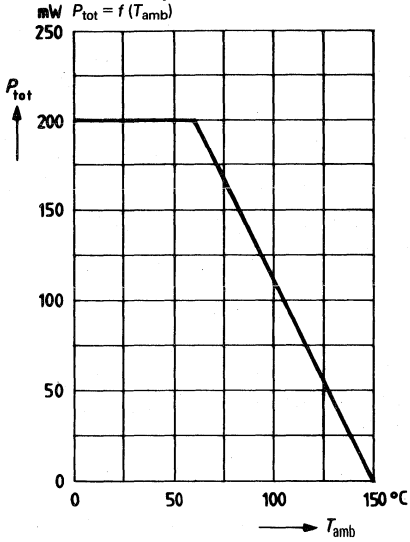

Family of output characteristics

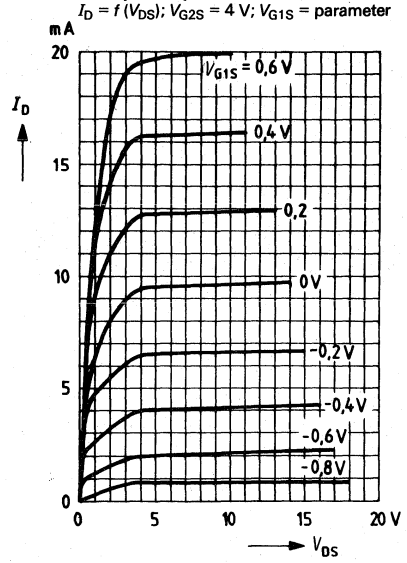

Gate 1 transmittance $g_{fs1} = f(V_{G1S})$

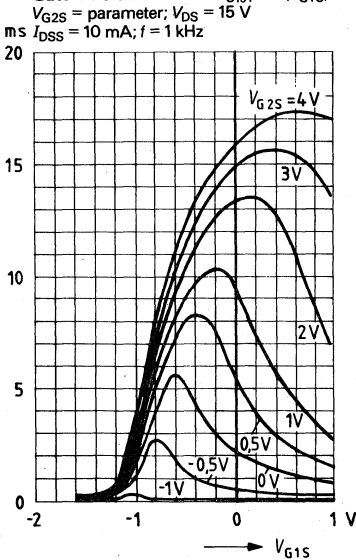

Gate 2 transmittance $g_{fs2} = f(V_{G2S})$

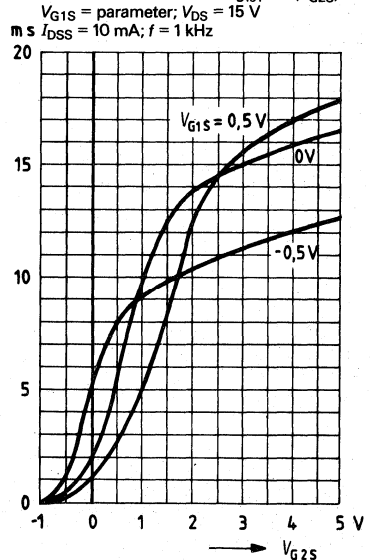

Gate 1 input capacitance

$C_{g1ss} = f(V_{G1})$; $V_{G2S} = 4\text{ V}$
 $V_{DS} = 15\text{ V}$; $f = 1\text{ MHz}$; $I_{DSS} = 10\text{ mA}$

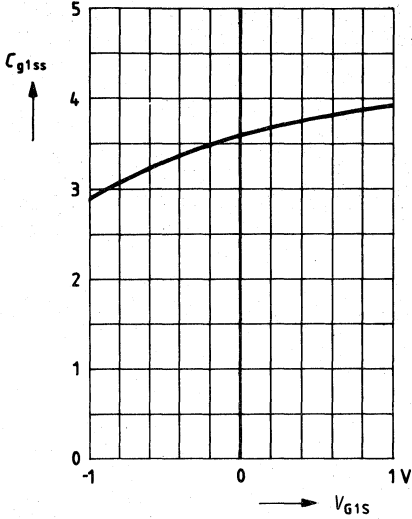

Gate 2 input capacitance

$C_{g2ss} = f(V_{G2S})$; $V_{G1S} = 0$
 $V_{DS} = 15\text{ V}$; $f = 1\text{ MHz}$; $I_{DSS} = 10\text{ mA}$

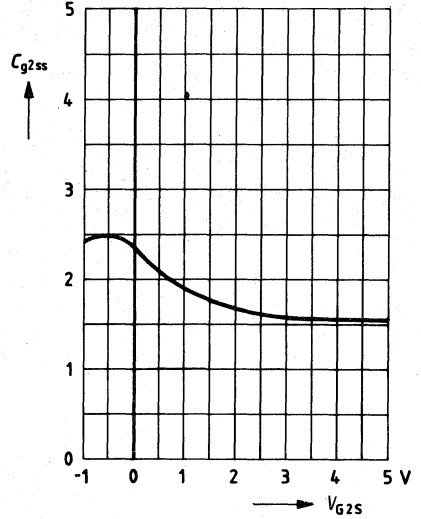

Output capacitance

$C_{dss} = f(V_{DS})$; $V_{G1S} = 0$;
 $V_{G2S} = 4\text{ V}$; $f = 1\text{ MHz}$; $I_{DSS} = 10\text{ mA}$

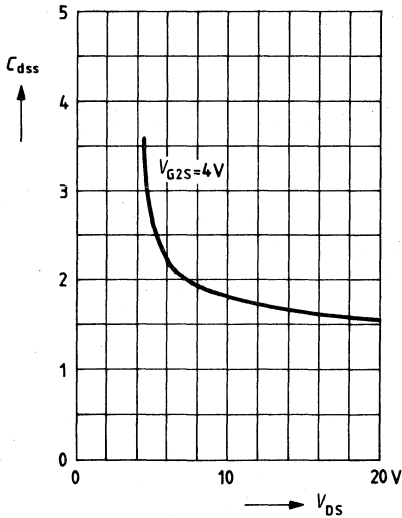

Gate 1 input conductance g_{1fs}

(source circuit); $V_{DS} = 15\text{ V}$;
 $V_{G2S} = 4\text{ V}$; $I_{DSS} = 10\text{ mA}$

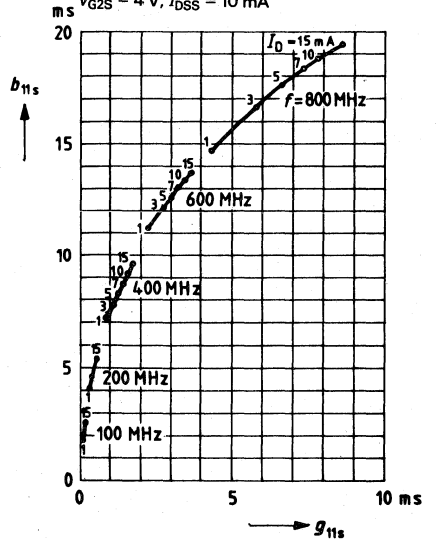

Gate 1 transmittance y_{21s}
(source circuit); $V_{DS} = 15\text{ V}$;
 $V_{G2S} = 4\text{ V}$; $I_{DSS} = 10\text{ mA}$

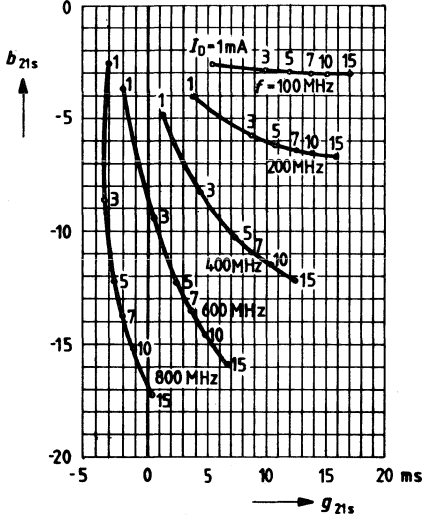

Output conductance y_{22s}
(source circuit); $V_{DS} = 15\text{ V}$;
 $V_{G2} = 4\text{ V}$; $I_{DSS} = 10\text{ mA}$

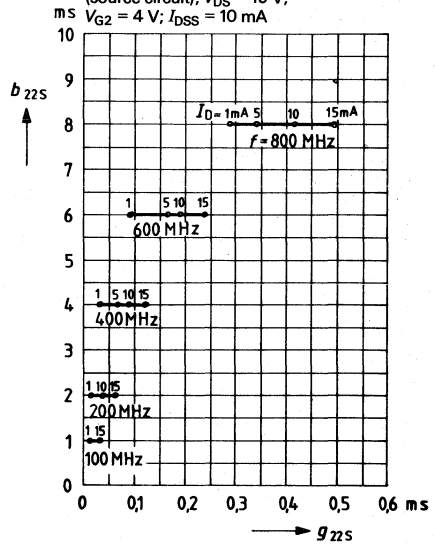

Power gain $G_{ps} = f(V_{G2S})$
 $V_{DS} = 15\text{ V}$; $V_{G1S} = 0$
 $I_{DSS} = 10\text{ mA}$; $f = 200\text{ MHz}$
(see figure 1)

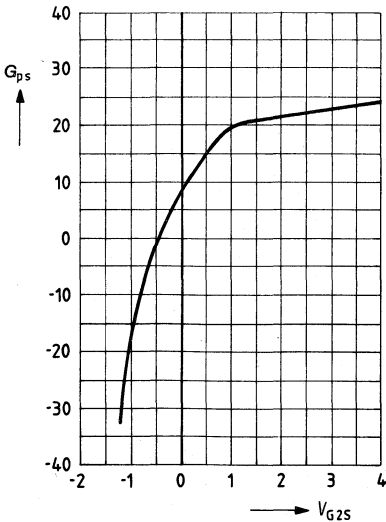

Noise figure $NF = f(V_{G2S})$
 $V_{DS} = 15\text{ V}$; $V_{G1S} = 0$
 $I_{DSS} = 10\text{ mA}$; $f = 200\text{ MHz}$ $R_S = 0\Omega$
(see figure 1)

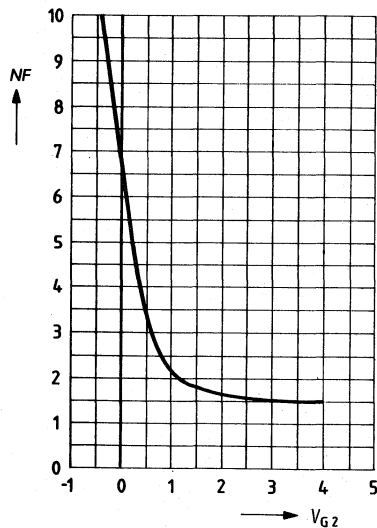

Mixer gain (additive) $G_{psc} = f(V_{osc})$
 $V_D = 15\text{ V}; V_{G1} = 0; V_{G2} = 6\text{ V}; R_S = 220\ \Omega$
 $I_{DSS} = 10\text{ mA}; f = 200\text{ MHz}; f_{IF} = 36\text{ MHz};$
 $2\ \Delta f_{IF} = 5\text{ MHz}$; (see figure 2)

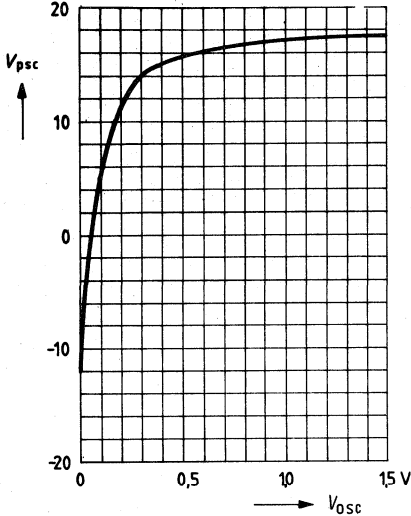

Mixer gain (additive) $G_{psc} = f(V_{G2})$
 $V_D = 15\text{ V}; V_G = 0; R_S = 220\ \Omega;$
 $V_{osc} = 0.5\text{ V}; I_{DSS} = 10\text{ mA}; f = 200\text{ MHz};$
 $f_{IF} = 36\text{ MHz}; 2\ \Delta f_{IF} = 5\text{ MHz};$
 (see figure 2)

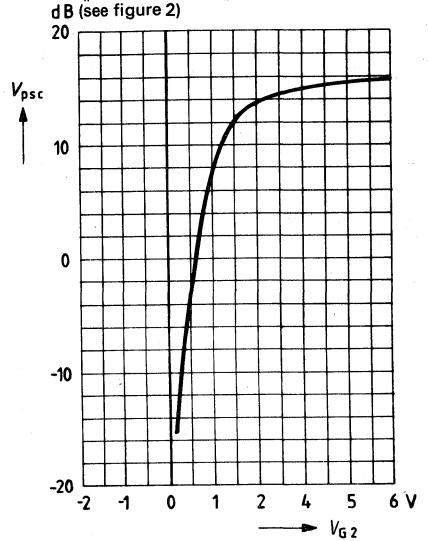

Mixer gain (additive) $G_{psc} = f(R_S)$
 $V_D = 15\text{ V}; V_{G1} = 0; V_{G2} = 6\text{ V}; V_{osc} = 0.5\text{ V};$
 $f = 200\text{ MHz}; f_{IF} = 36\text{ MHz}; 2\ \Delta f_{IF} = 5\text{ MHz}$
 (see figure 2)

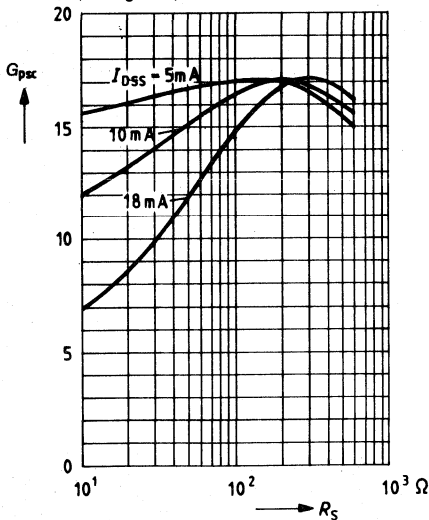

Mixer gain (multiplicative) $G_{psc} = f(V_{G2})$
 $V_D = 15\text{ V}; V_{G1} = 1.7\text{ V}; R_S = 200\ \Omega;$
 $I_{DSS} = 10\text{ mA}; f = 200\text{ MHz}; f_{IF} = 36\text{ MHz};$
 $2\ \Delta f_{IF} = 5\text{ MHz}$; (see figure 3)

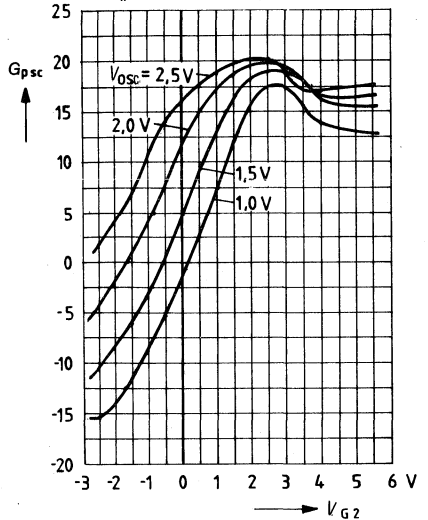

Interference voltage for 1% cross modulation

$V_{int(1\%)} = f(f_{int})^1$;
 $m_{int} = 100\%$; $f_e = 200$ MHz; $V_{DS} = 15$ V;
 $V_{G2S} = 4$ V; $V_{G1S} = 0$; $I_{DSS} = 10$ mA
 (see figure 1)

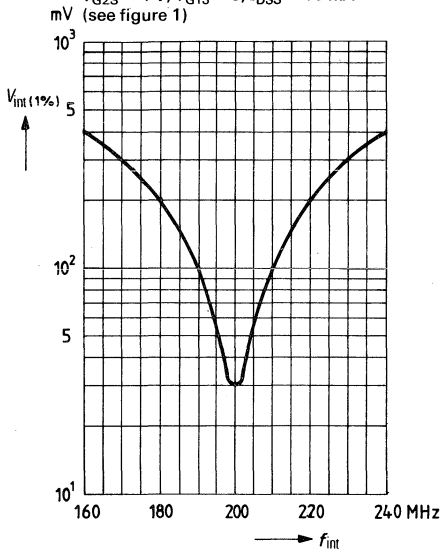

Interference voltage for 1% cross modulation

$V_{int(1\%)} = f(\Delta V_p)^1$;
 $f_e = 200$ MHz; $f_{int} = 221$ MHz; $m_{int} = 100\%$;
 $V_{DS} = 15$ V; $V_{G1} = 0$; $I_{DSS} = 10$ mA
 (see figure 1)

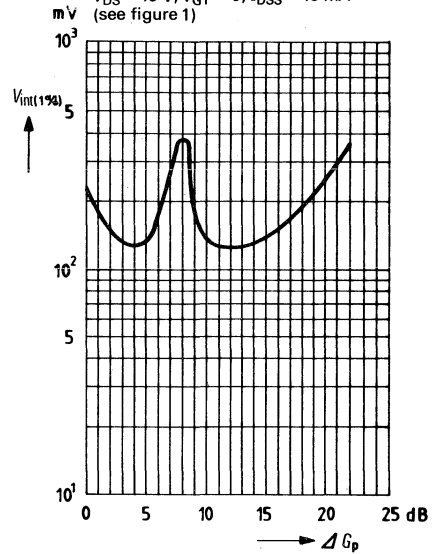

Test circuit for power gain, noise figure, and cross modulation $f = 200$ MHz

Fig. 1

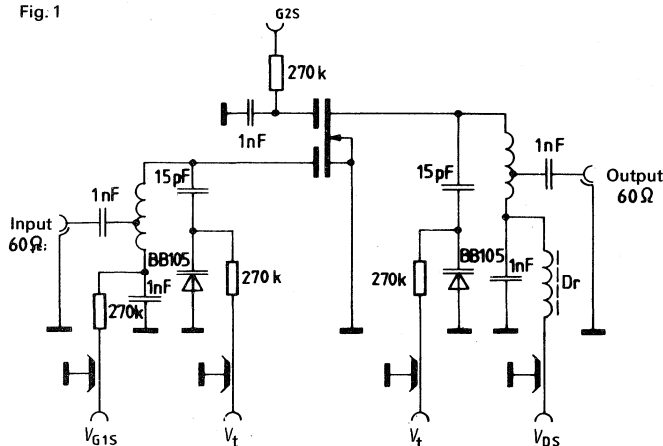

1) V_{int} 1% is the rms value of half the EMC (terminal voltage at matching) of a 100% sine modulated TV carrier at an internal generator resistance of 60 Ω, causing 1% amplitude modulation on the active carrier.

Test circuit for mixer gain (additive)

$f = 200 \text{ MHz}; f_{\text{osc}} = 236 \text{ MHz}; 2 \Delta f_{\text{IF}} = 5 \text{ MHz}$

Fig. 2

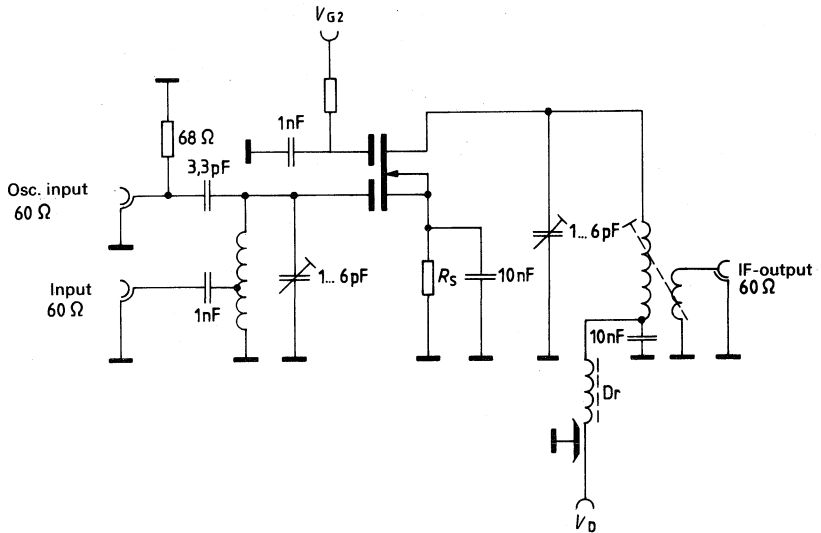

Test circuit for mixer gain (multiplicative)

$f = 200 \text{ MHz}; f_{\text{osc}} = 236 \text{ MHz}; 2 \Delta f_{\text{IF}} = 5 \text{ MHz}$

Fig. 3

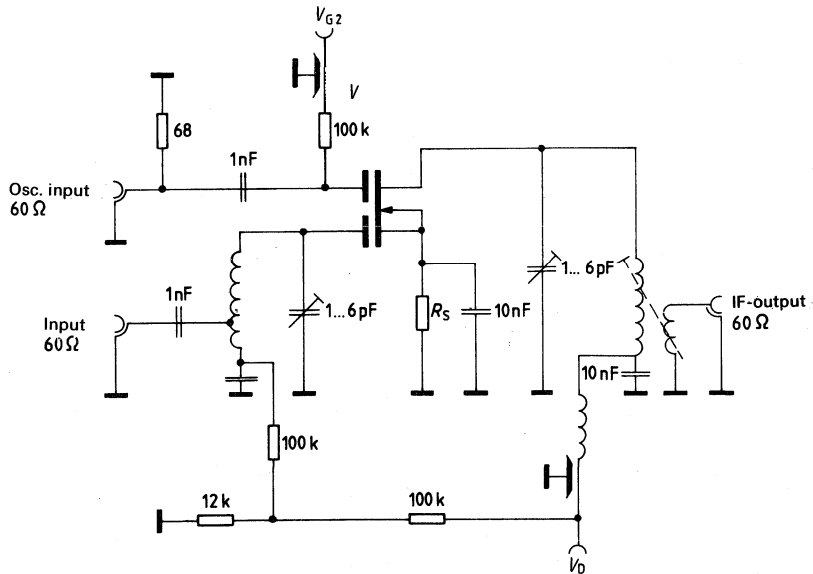

for input stages up to 900 MHz

BF 967 is a PNP silicon UHF planar transistor with passivated surface in a low-capacitance plastic package similar to TO 119 (50 B 3 DIN 41 867). The transistor is particularly suitable for use in low noise, gain-controlled input stages up to 900 MHz in tuners with diode tuning.

Type	Ordering code
BF 967	Q62702-F503

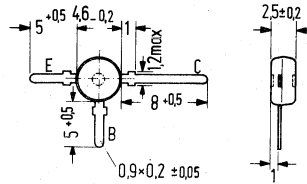

Approx. weight 0.25 g Dimensions in mm

Maximum ratings

Collector-emitter voltage	$-V_{CEO}$	30	V
Collector-base voltage	$-V_{CBO}$	30	V
Emitter-base voltage	$-V_{EBO}$	3	V
Collector current	$-I_C$	20	mA
Base current	$-I_B$	5	mA
Junction temperature	T_j	150	°C
Storage temperature range	T_{stg}	-55 to +150	°C
Total power dissipation	P_{tot}	160	mW

Thermal resistance

Junction to ambient air	R_{thJA}	600	K/W
-------------------------	------------	-----	-----

Static characteristics ($T_{amb} = 25^{\circ}\text{C}$)

Collector cutoff current

($-V_{CBO} = 15\text{ V}$)

$-I_{CBO}$	1 (<100)	nA
------------	----------	----

DC current gain

($-V_{CE} = 10\text{ V}; -I_C = 1\text{ mA}$)

h_{FE}	60 (>15)	-
----------	----------	---

Emitter cutoff current

($-I_C = 0; -V_{EB} = 1\text{ V}$)

$-I_{EBO}$	<100	nA
------------	------	----

Dynamic characteristics ($T_{amb} = 25^{\circ}\text{C}$)

Transition frequency

($-I_C = 3\text{ mA}; -V_{CE} = 10\text{ V}; f = 100\text{ MHz}$)

f_T	950	MHz
-------	-----	-----

Reverse transfer capacitance

($-V_{CE} = 1\text{ V}; f = 1\text{ MHz}$)

C_{12b}	80	fF
-----------	----	----

Collector-base capacitance

($-V_{CB} = 10\text{ V}; f = 1\text{ MHz}$)

$-C_{CBO}$	0.42	pF
------------	------	----

Power gain

($-I_C = 3\text{ mA}; -V_{CB} = 10\text{ V}; f = 800\text{ MHz};$

$R_L = 500\ \Omega$)

G_{pb}	13	dB
----------	----	----

Noise figure

($-I_C = 3\text{ mA}; -V_{CB} = 10\text{ V}; f = 800\text{ MHz};$

$R_g = 60\ \Omega$)

NF	4	dB
------	---	----

for input stages up to 900 MHz

BF 968 is a PNP silicon UHF planar transistor with passivated surface in a low-capacitance plastic package similar to TO 119 (50 B 3 DIN 41 867). The transistor is particularly suitable for use in low noise, gain-controlled input stages up to 900 MHz in tuners with diode tuning.

Type	Ordering code
BF 968	Q62702-F612

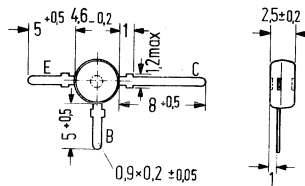

Approx. weight 0.25 g Dimensions in mm

Maximum ratings

Collector-emitter voltage	$-V_{CEO}$	35	V
Collector-base voltage	$-V_{CBO}$	40	V
Emitter-base voltage	$-V_{EBO}$	3	V
Collector current	$-I_C$	30	mA
Base current	$-I_B$	5	mA
Junction temperature	T_j	150	°C
Storage temperature range	T_{stg}	-55 to +150	°C
Total power dissipation	P_{tot}	160	mW

Thermal resistance

Junction to ambient air	R_{thJA}	600	K/W
-------------------------	------------	-----	-----

Static characteristics ($T_{\text{amb}} = 25^{\circ}\text{C}$)

Collector cutoff current ($-V_{\text{CBO}} = 15\text{ V}$)	$-I_{\text{CBO}}$	1 (<100)	nA
DC current gain ($-V_{\text{CE}} = 10\text{ V}$; $-I_{\text{C}} = 1\text{ mA}$)	h_{FE}	60 (>25)	-
Emitter cutoff current ($-I_{\text{C}} = 0$; $-V_{\text{BE}} = 3\text{ V}$)	$-I_{\text{EBO}}$	<10	μA

Dynamic characteristics ($T_{\text{amb}} = 25^{\circ}\text{C}$)

Transition frequency ($-I_{\text{C}} = 3\text{ mA}$; $-V_{\text{CE}} = 10\text{ V}$; $f = 100\text{ MHz}$)	f_{T}	1.1	GHz
Reverse transfer capacitance ($-V_{\text{CE}} = 1\text{ V}$; $f = 1\text{ MHz}$)	$C_{12\text{b}}$	0.1	pF
Collector-base capacitance ($-V_{\text{CB}} = 10\text{ V}$; $f = 1\text{ MHz}$)	$-C_{\text{CBO}}$	0.45	pF
Power gain ($-I_{\text{C}} = 3\text{ mA}$; $-V_{\text{CB}} = 10\text{ V}$; $f = 800\text{ MHz}$; $R_{\text{L}} = 500\ \Omega$)	G_{pb}	14.5	dB
Noise figure ($-I_{\text{C}} = 3\text{ mA}$; $-V_{\text{CB}} = 10\text{ V}$; $f = 800\text{ MHz}$; $R_{\text{g}} = 60\ \Omega$)	NF	3 (<4)	dB
Collector current for G_{pbmax} ($V_{\text{CC}} = 12\text{ V}$; $R_{\text{CC}} = 1\text{ k}\Omega$; $f = 800\text{ MHz}$; $R_{\text{L}} = 500\ \Omega$)	I_{C}	3.5	mA

BF 970 is a PNP silicon planar transistor in a low capacitance plastic package similar to TO 119 (50 B 3 DIN 41867).

The transistor is particularly intended for use in UHF mixers and oscillator stages.

Type	Ordering code
BF 970	Q62702-F611

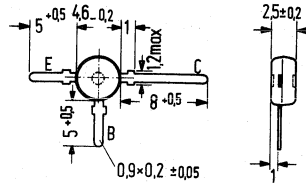

Approx. weight 0.25 g Dimensions in mm

Maximum ratings

Collector-emitter voltage	$-V_{CEO}$	35	V
Collector-base voltage	$-V_{CBO}$	40	V
Emitter-base voltage	$-V_{EBO}$	3	V
Collector current	$-I_C$	30	mA
Base current	$-I_B$	5	mA
Junction temperature	T_j	150	°C
Storage temperature range	T_{stg}	-50 to +150	°C
Total power dissipation	P_{tot}	160	mW

Thermal resistance

Junction to ambient air	R_{thJA}	< 600	K/W
-------------------------	------------	-------	-----

Static characteristics ($T_{amb} = 25^{\circ}\text{C}$)

Collector cutoff current

($-V_{CBO} = 20\text{ V}$) $-I_{CBO}$ | <100 | nA

DC current gain

($-I_C = 3\text{ mA}$; $-V_{CE} = 10\text{ V}$) h_{FE} | 50 (>25) | -**Dynamic characteristics** ($T_{amb} = 25^{\circ}\text{C}$)

Transition frequency

($-I_C = 3\text{ mA}$; $-V_{CE} = 10\text{ V}$; $f = 100\text{ MHz}$) f_T | 850 | MHz

Reverse transfer capacitance

($-V_{CE} = 1\text{ V}$; $f = 1\text{ MHz}$) C_{12b} | 0.1 | pF

Collector-base capacitance

($-V_{CB} = 10\text{ V}$; $f = 1\text{ MHz}$) $-C_{CBO}$ | 0.45 | pF

Noise figure

($-I_C = 3\text{ mA}$; $-V_{CB} = 10\text{ V}$; $R_g = 60\ \Omega$,
 $f = 800\text{ MHz}$) NF | 4.5 | dB

Power gain

($-I_C = 3\text{ mA}$; $-V_{CB} = 10\text{ V}$; $f = 800\text{ MHz}$;
 $R_L = 500\ \Omega$) G_{pb} | 14.5 | dBCollector current for G_{pbmax} ($V_{CC} = 12\text{ V}$; $R_{CC} = 1\text{ k}\Omega$; $f = 800\text{ MHz}$; $R_L = 500\ \Omega$) I_C | 4.5 | mA

BF 979 S is a PNP silicon planar transistor in low-capacitance plastic package similar to TO 119 (50 B 3 DIN 41867).

The transistor is particularly suitable for use in uncontrolled UHF and VHF input stages featuring low cross modulation.

Type	Ordering code
BF 979 S	Q62702-F610

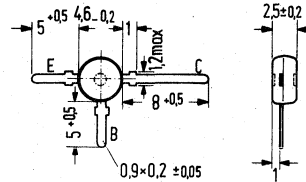

Approx. weight 0.25 g Dimensions in mm

Maximum ratings

Collector-emitter voltage	$-V_{CEO}$	25	V
Collector-base voltage	$-V_{CBS}$	30	V
Emitter-base voltage	$-V_{EBO}$	3	V
Collector current	$-I_C$	50	mA
Junction temperature	T_j	150	°C
Storage temperature range	T_{stg}	-50 to +150	°C
Total power dissipation	P_{tot}	160	mW

Thermal resistance

Junction to ambient air	R_{thJA}	< 600	K/W
-------------------------	------------	-------	-----

Static characteristics ($T_{amb} = 25^{\circ}\text{C}$)

Collector cutoff current

($-V_{CBO} = 20\text{ V}$)

DC power gain

($-I_C = 10\text{ mA}$; $-V_{CE} = 10\text{ V}$)

$-I_{CBO}$	< 100	nA
h_{FE}	> 20	-

Dynamic characteristics ($T_{amb} = 25^{\circ}\text{C}$)

Transition frequency

($-I_C = 10\text{ mA}$; $-V_{CE} = 10\text{ V}$; $f = 100\text{ MHz}$)

Reverse transfer capacitance

($-V_{CE} = 1\text{ V}$; $f = 1\text{ MHz}$)

Collector-base capacitance

($-V_{CB} = 10\text{ V}$; $f = 1\text{ MHz}$)

Noise figure

($-I_C = 10\text{ mA}$; $-V_{CB} = 10\text{ V}$; $f_M = 200\text{ MHz}$;

$R_g = 60\ \Omega$)

Noise figure

($-I_C = 10\text{ mA}$; $-V_{CB} = 10\text{ V}$; $f_M = 800\text{ MHz}$;

$R_g = 60\ \Omega$)

Power gain

($-I_C = 10\text{ mA}$; $-V_{CB} = 10\text{ V}$; $f_M = 800\text{ MHz}$;

$R_L = 500\ \Omega$)

Interference voltage¹⁾

($-I_C = 10\text{ mA}$; $-V_{CB} = 10\text{ V}$; $f_M = 200\text{ MHz}$;

$R_g = 75\ \Omega$)

Collector current for G_{pbmax} ($-V_{CB} = 10\text{ V}$;

$f_M = 800\text{ MHz}$; $R_L = 500\ \Omega$)

f_T	1.6	GHz
C_{12b}	90	fF
$-C_{CBO}$	0.55	pF
NF	3	dB
NF	< 4.5	dB
G_{pb}	16.5	dB
$V_{int\ 1\%}$	230	mV
I_C	> 10	mA

1) $V_{int\ 1\%}$ is the rms value of half the EMF of a 100% sine modulated TV carrier with $R_g = 75\ \Omega$, which causes 1% AM on the useful carrier.

BFN 16 and BFN 18 are epitaxial NPN silicon planar transistors in SOT 89 plastic package, intended for use in film circuits. The transistors are particularly suitable for applications in video circuits as well as for general switching applications at high currents, high reverse voltages and at low saturation voltages.

Complementary types are BFN 17 and BFN 19.

Type	Mark	Ordering code
BFN 16	DD	Q62702-F694
BFN 18	DE	Q62702-F696

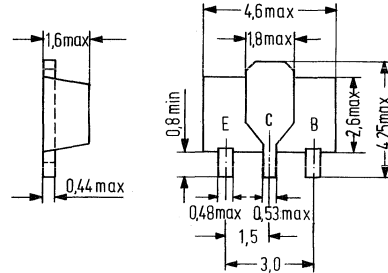

Approx. weight 0.1 g Dimensions in mm

Maximum ratings ($T_{amb} = 25\text{ }^{\circ}\text{C}$)

- Collector-emitter voltage
- Collector-base voltage
- Collector current
- Collector peak current ($t_p \leq 10\text{ ms}$)
- Base current
- Junction temperature
- Storage temperature range
- Total power dissipation ($T_{SB} \leq 60\text{ }^{\circ}\text{C}$)¹⁾

	BFN 16	BFN 18	
V_{CEO}	250	300	V
V_{CBO}	250	300	V
I_C	200	200	mA
I_{CM}	500	500	mA
I_B	100	100	mA
T_j	150	150	$^{\circ}\text{C}$
T_{stg}	-65 to +150		$^{\circ}\text{C}$
P_{tot}	2	2	W

Thermal resistance

Junction to substrate back¹⁾

R_{thJSB}	< 45	< 45	K/W
-------------	------	------	-----

1) Ceramic substrate 0.7 mm with 2.5 cm² area.

2) T_{SB} = temperature of the substrate back below the transistor. In case of cementing the substrate on a heat sink, T_{SB} equals the heat sink temperature

Static characteristics ($T_{amb} = 25^{\circ}\text{C}$)

Collector-emitter breakdown voltage

 ($I_C = 10\text{ mA}$)

Collector-base breakdown voltage

 ($I_C = 100\text{ }\mu\text{A}$)

Emitter-base breakdown voltage

 ($I_E = 100\text{ }\mu\text{A}$)

Collector cutoff current

 ($V_{CB} = 200\text{ V}$)

 ($V_{CB} = 250\text{ V}$)

Emitter cutoff current

 ($V_{EB} = 4\text{ V}$)

Collector-emitter saturation voltage

 ($I_C = 20\text{ mA}$; $I_B = 2\text{ mA}$)

Base-emitter saturation voltage

 ($I_C = 20\text{ mA}$; $I_B = 2\text{ mA}$)

DC current gain

 ($I_C = 1\text{ mA}$; $V_{CE} = 10\text{ V}$)

 ($I_C = 10\text{ mA}$; $V_{CE} = 10\text{ V}$)

 ($I_C = 30\text{ mA}$; $V_{CE} = 10\text{ V}$)

	BFN 16	BFN 18	
$V_{(BR)CEO}$	> 250	> 300	V
$V_{(BR)CBO}$	> 250	> 300	V
$V_{(BR)EBO}$	> 5	> 5	V
I_{CBO}	< 100	–	nA
I_{CBO}	–	< 100	nA
I_{EBO}	< 100	< 100	nA
V_{CEsat}	< 0.4	< 0.5	V
V_{BEsat}	< 0.9	< 0.9	V
h_{FE}	> 25	> 25	–
h_{FE}	> 40	> 40	–
h_{FE}	> 40	> 30	–

Dynamic characteristics ($T_{amb} = 25^{\circ}\text{C}$)

Transition frequency

 ($I_C = 10\text{ mA}$; $V_{CE} = 10\text{ V}$; $f = 20\text{ MHz}$)

f_T	> 60	> 60	MHz
-------	------	------	-----

BFN 17 and BFN 19 are epitaxial PNP silicon planar transistors in SOT 89 plastic package, intended for use in film circuits. The transistors are particularly suitable for applications in video circuits as well as for general switching applications at high currents, high reverse voltages and at low saturation voltages.

Complementary types are BFN 16 and BFN 18.

Type	Mark	Ordering code
BFN 17	DG	Q62702-F695
BFN 19	DH	Q62702-F697

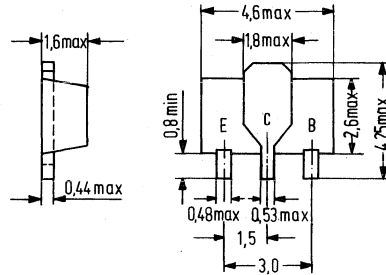

Approx. weight 0.1 g Dimensions in mm

Maximum ratings ($T_{amb} = 25^{\circ}\text{C}$)

Collector-emitter voltage
 Collector-base voltage
 Collector current
 Collector peak current ($t_p \leq 10 \text{ ms}$)
 Base current
 Junction temperature
 Storage temperature range
 Total power dissipation
 ($T_{SB} \leq 60^{\circ}\text{C}$)²⁾

	BFN 17	BFN 19	
$-V_{CEO}$	250	300	V
$-V_{CBO}$	250	300	V
$-I_C$	200	200	mA
$-I_{CM}$	500	500	mA
$-I_B$	100	100	mA
T_j	150	150	$^{\circ}\text{C}$
T_{stg}	-65 to +150		$^{\circ}\text{C}$
P_{tot}	2	2	W

Thermal resistance

Junction to substrate back¹⁾

R_{thJSB}	<45	<45	K/W
-------------	-----	-----	-----

1) Ceramic substrate 0.7 mm with 2.5 cm² area.

2) T_{SB} = temperature of the substrate back below the transistor. In case of cementing the substrate on a heat sink, T_{SB} equals the heat sink temperature.

Static characteristics ($T_{amb} = 25\text{ C}$)

Collector-emitter breakdown voltage

($-I_C = 10\text{ mA}$)

Collector-base breakdown voltage

($-I_C = 100\text{ }\mu\text{A}$)

Emitter-base breakdown voltage

($-I_E = 100\text{ }\mu\text{A}$)

Collector cutoff current

($-V_{CB} = 200\text{ V}$)

($-V_{CB} = 250\text{ V}$)

Emitter cutoff current

($-V_{EB} = 4\text{ V}$)

Collector-emitter saturation voltage

($-I_C = 20\text{ mA}$; $-I_B = 2\text{ mA}$)

Base-emitter saturation voltage

($-I_C = 20\text{ mA}$; $-I_B = 2\text{ mA}$)

DC current gain

($-I_C = 1\text{ mA}$; $-V_{CE} = 10\text{ V}$)

($-I_C = 10\text{ mA}$; $-V_{CE} = 10\text{ V}$)

($-I_C = 30\text{ mA}$; $-V_{CE} = 10\text{ V}$)

	BFN 17	BFN 19	
$-V_{(BR)CEO}$	> 250	> 300	V
$-V_{(BR)CBO}$	> 250	> 300	V
$-V_{(BR)EBO}$	> 5	> 5	V
$-I_{CBO}$	< 100	-	nA
$-I_{CBO}$	-	< 100	nA
$-I_{EBO}$	< 100	< 100	nA
$-V_{CEsat}$	< 0.4	< 0.5	V
$-V_{BEsat}$	< 0.9	< 0.9	V
h_{FE}	> 25	> 25	-
h_{FE}	> 40	> 40	-
h_{FE}	> 40	> 30	-

Dynamic characteristics ($T_{amb} = 25\text{ C}$)

Transition frequency

($-I_C = 10\text{ mA}$; $-V_{CE} = 10\text{ V}$; $f = 20\text{ MHz}$)

f_T	> 60	> 60	MHz
-------	------	------	-----

BFN 20 is an epitaxial NPN silicon planar transistor in SOT 89 plastic package. It is the complementary type to BFN 21.

The transistor is particularly suitable for use in video B output stages of thin and thick film circuits. It is marked with the code letters "DC".

Type	Mark	Ordering code
BFN 20	DC	Q62702-F584

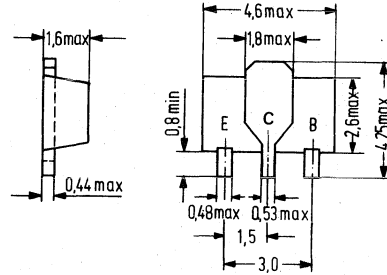

Approx. weight 0.1 g Dimensions in mm

Maximum ratings ($T_{amb} = 25^{\circ}\text{C}$)

- Collector-emitter voltage ($R_{BE} = 2.7 \text{ k}\Omega$)
- Collector-base voltage
- Collector-emitter voltage
- Emitter-base voltage
- Collector current
- Collector peak current
- Junction temperature
- Storage temperature range
- Total power dissipation ($T_{SB} = 60^{\circ}\text{C}$)¹⁾
(Ceramic substrate 0.7 mm with 2.5 cm² area)

V_{CER}	300	V
V_{CBO}	300	V
V_{CEO}	300	V
V_{EBO}	5	V
I_C	20	mA
I_{CM}	100	mA
T_j	150	$^{\circ}\text{C}$
T_{stg}	-65 to +150	$^{\circ}\text{C}$
P_{tot}	2	W

Thermal resistance

- Junction to substrate back
- Ceramic substrate 0.7 mm with 2.5 cm² area

R_{thJSB}	45	K/W
-------------	----	-----

1) T_{SB} = temperature of the substrate back below the transistor. In case of cementing the substrate on a heat sink, T_{SB} equals the heat sink temperature.

Static characteristics ($T_{amb} = 25^{\circ}\text{C}$)

Collector-emitter breakdown voltage ($R_{BE} = 2.7\text{ k}\Omega$)	$V_{(BR)CER}$	> 300	V
Collector-base breakdown voltage	$V_{(BR)CBO}$	> 300	V
Collector-emitter breakdown voltage	$V_{(BR)CEO}$	> 300	V
Emitter-base breakdown voltage	$V_{(BR)EBO}$	> 5	V
Collector cutoff current ($V_{CB} = 250\text{ V}$)	I_{CBO}	< 100	nA
Collector cutoff current ($R_{BE} = 2.7\text{ k}\Omega$, $V_{CE} = 300\text{ V}$; $T_j = 150^{\circ}\text{C}$)	I_{CER}	< 50	μA
($R_{BE} = 2.7\text{ k}\Omega$, $V_{CE} = 300\text{ V}$; $T_{amb} = 25^{\circ}\text{C}$)	I_{CER}	< 1	μA
Emitter cutoff current ($V_{EB} = 5\text{ V}$)	I_{EBO}	< 10	μA
Collector-emitter saturation voltage ($I_C = 25\text{ mA}$; $T_j = 150^{\circ}\text{C}$)	$V_{CEsatRF}$	20	V
Collector-emitter saturation voltage ($I_C = 10\text{ mA}$; $I_B = 1\text{ mA}$)	V_{CEsat}	< 0.5	V
Collector-base saturation voltage ($I_C = 10\text{ mA}$; $I_B = 1\text{ mA}$)	V_{BEsat}	< 1	V
DC current gain ($I_C = 25\text{ mA}$; $V_{CE} = 20\text{ V}$)	h_{FE}	> 40	–

Dynamic characteristics ($T_{amb} = 25^{\circ}\text{C}$)

Transition frequency ($V_{CE} = 10\text{ V}$; $I_C = 10\text{ mA}$)	f_T	> 60	MHz
Reverse transfer capacitance ($V_{CB} = 30\text{ V}$)	$-C_{12e}$	< 1.6	pF
Feedback time constant ($V_{CB} = 20\text{ V}$; $-I_E = 10\text{ mA}$; $f = 10.7\text{ MHz}$)	r_{bb} , C_{bb}	< 70	ps

Total perm. power dissipation versus temperature
 $P_{tot} = f(T)$

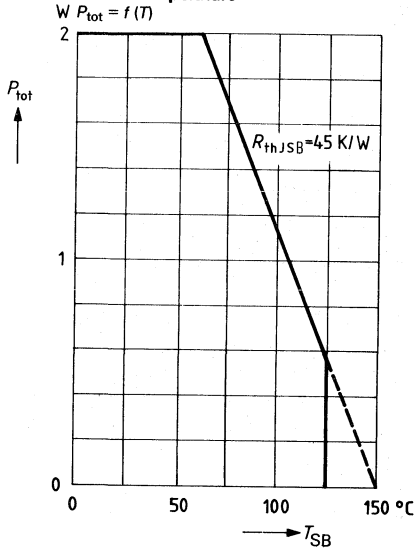

Permissible pulse load $r_{thJSB} = f(t)$
 $v = \text{parameter}$

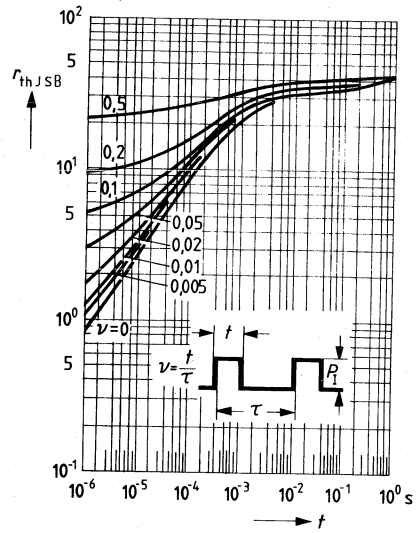

Collector current $I_C = f(V_{BE})$
 $V_{CE} = 10 \text{ V}; T_{case} = 25^\circ\text{C}$

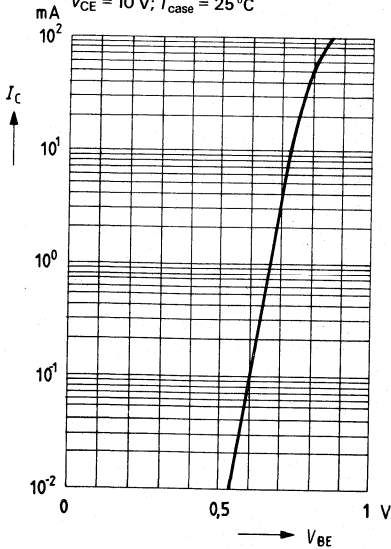

DC current gain $h_{FE} = f(I_C)$
 $V_{CE} = 10 \text{ V}; T_{case} = 25^\circ\text{C}$

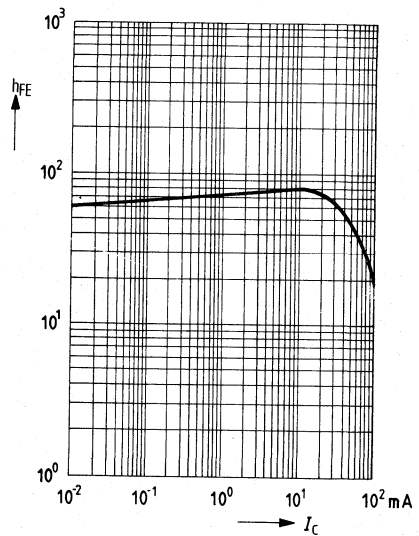

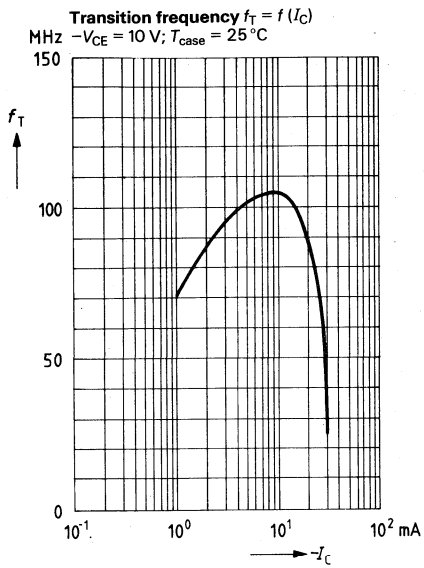

BFN 21 is an epitaxial PNP silicon planar transistor in SOT 89 plastic package. It is the complementary type to BFN 20.

The transistor is particularly suitable for use in video B output stages of thin and thick film circuits. It is marked with the code letters "DF".

Type	Mark	Ordering code
BFN 21	DF	O62702-F585

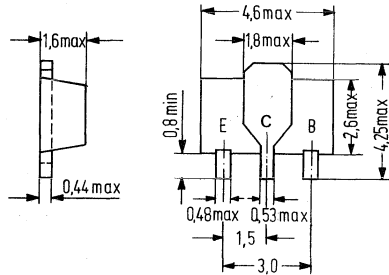

Approx. weight 0.1 g

Dimensions in mm

Maximum ratings ($T_{amb} = 25^{\circ}\text{C}$)

Collector-emitter voltage ($R_{BE} = 2.7 \text{ k}\Omega$)

Collector-base voltage

Collector-emitter voltage

Emitter-base voltage

Collector current

Collector peak current

Junction temperature

Storage temperature range

Total power dissipation ($T_{SB} = 60^{\circ}\text{C}$)¹⁾

Ceramic substrate 0.7 mm with 2.5 cm² area

$-V_{CER}$	300	V
$-V_{CBO}$	300	V
$-V_{CEO}$	300	V
$-V_{EBO}$	5	V
$-I_C$	20	mA
$-I_{CM}$	100	mA
T_j	150	$^{\circ}\text{C}$
T_{stg}	-65 to +150	$^{\circ}\text{C}$
P_{tot}	2	W

Thermal resistance

Junction to substrate back

Ceramic substrate 0.7 mm with 2.5 cm² area

R_{thJSB}	45	K/W
-------------	----	-----

1) T_{SB} = temperature of the substrate back below the transistor. In case of cementing the substrate on a heat sink, T_{SB} equals the heat sink temperature.

Static characteristics ($T_{amb} = 25^{\circ}\text{C}$)

Collector-emitter breakdown voltage ($R_{BE} = 2.7\text{ k}\Omega$)	$-V_{(BR)CER}$	> 300	V
Collector-base breakdown voltage	$-V_{(BR)CBO}$	> 300	V
Collector-emitter breakdown voltage	$-V_{(BR)CEO}$	> 300	V
Emitter-base breakdown voltage	$-V_{(BR)EBO}$	> 5	V
Collector cutoff current ($-V_{CB} = 250\text{ V}$)	$-I_{CBO}$	< 100	nA
Collector cutoff current ($R_{BE} = 2.7\text{ k}\Omega$, $-V_{CE} = 300\text{ V}$; $T_j = 150^{\circ}\text{C}$)	$-I_{CER}$	< 50	μA
($R_{BE} = 2.7\text{ k}\Omega$, $-V_{CE} = 300\text{ V}$; $T_{amb} = 25^{\circ}\text{C}$)	$-I_{CER}$	< 1	μA
Emitter cutoff current ($-V_{BE} = 5\text{ V}$)	$-I_{EBO}$	< 10	μA
Collector-emitter saturation voltage ($-I_C = 25\text{ mA}$; $T_j = 150^{\circ}\text{C}$)	$-V_{CEsatRF}$	20	V
Collector-emitter saturation voltage ($-I_C = 10\text{ mA}$; $-I_B = 1\text{ mA}$)	$-V_{CEsat}$	< 1	V
Collector-base saturation voltage ($-I_C = 10\text{ mA}$)	$-V_{BEsat}$	< 1	V
DC current gain ($-I_C = 25\text{ mA}$; $-V_{CE} = 20\text{ V}$)	h_{FE}	> 40	–

Dynamic characteristics ($T_{amb} = 25^{\circ}\text{C}$)

Transition frequency ($-V_{CE} = 10\text{ V}$; $-I_C = 10\text{ mA}$)	f_T	> 60	MHz
Reverse transfer capacitance ($-V_{CB} = 30\text{ V}$)	$-C_{12e}$	< 1.6	pF
Feedback time constant ($-V_{CB} = 20\text{ V}$; $I_E = 10\text{ mA}$; $f = 10.7\text{ MHz}$)	r_{bb}, C_{bb}	< 70	ps

Total perm. power dissipation versus temperature

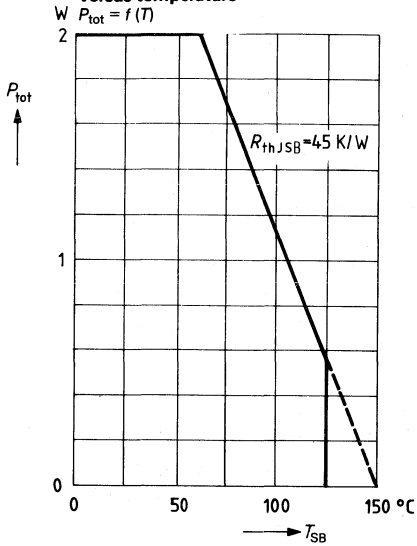

Permissible pulse load
 $r_{thJSB} = f(t); v = \text{parameter}$

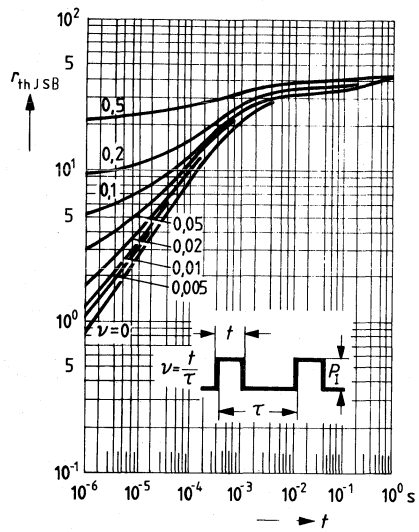

Collector current $I_C = f(V_{BE})$
 $-V_{CE} = 10 \text{ V}; T_{case} = 25^\circ\text{C}$

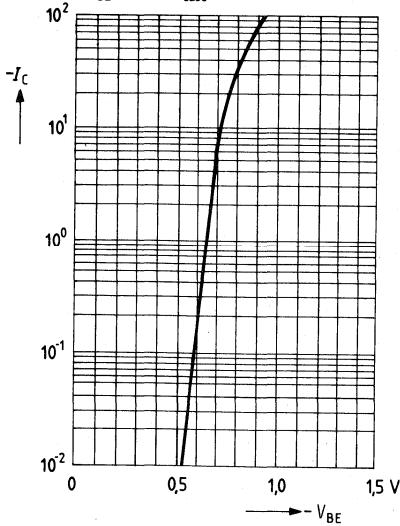

DC current gain $h_{FE} = f(I_C)$
 $-V_{CE} = 10 \text{ V}; T_{case} = 25^\circ\text{C}$

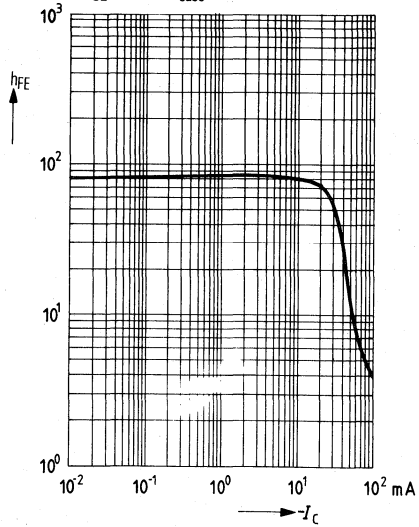

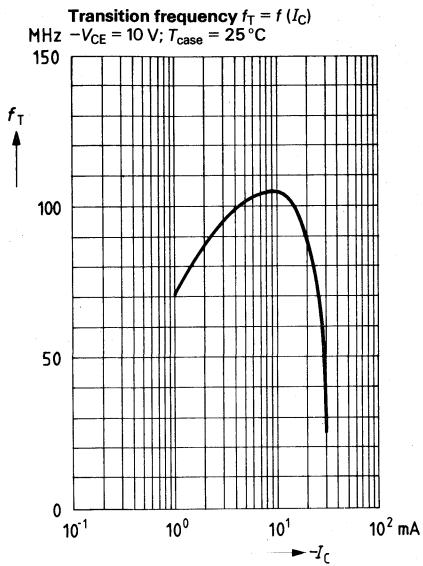

BFN 22 is an epitaxial NPN silicon planar transistor in TO 236 plastic package (23 A 3 DIN 41869). It is the complementary type to BFN 23.

The transistor is particularly suitable for use in video B output stages of thin and thick film circuits. It is marked with the code letters "HB".

Type	Mark	Ordering code
BFN 22	HB	Q62702-F596

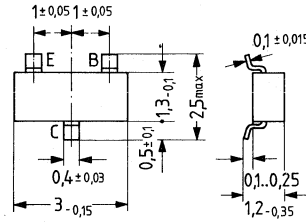

Approx. weight 0.02 g Dimensions in mm

Maximum ratings ($T_{amb} = 25^{\circ}\text{C}$)

Collector-base voltage	V_{CBO}	250	V
Collector-emitter voltage	V_{CEO}	250	V
Emitter-base voltage	V_{EBO}	5	V
Collector current	I_C	20	mA
Collector peak current	I_{CM}	50	mA
Junction temperature	T_j	150	$^{\circ}\text{C}$
Storage temperature range	T_{stg}	-65 to +125	$^{\circ}\text{C}$
Total power dissipation ($T_{SB} = 50^{\circ}\text{C}$)	P_{tot}	310	mW

Thermal resistance

Junction to ambient air	R_{thJA}	450	K/W
Junction to substrate back ¹⁾	R_{thJSB}	≤ 320	K/W

1) Ceramic substrate 0.7 mm; 2.5 cm² area

Static characteristics ($T_{amb} = 25^{\circ}\text{C}$)

Collector-emitter breakdown voltage ($R_{BE} = 2.7 \text{ k}\Omega$)	$V_{(BR)CER}$	> 250	V
Collector-base breakdown voltage	$V_{(BR)CBO}$	> 250	V
Collector-emitter breakdown voltage	$V_{(BR)CEO}$	> 250	V
Emitter-base breakdown voltage	$V_{(BR)EBO}$	> 5	V
Collector cutoff current ($V_{CB} = 200 \text{ V}$)	I_{CBO}	< 10	nA
Collector cutoff current ($R_{BE} = 2.7 \text{ k}\Omega$, $V_{CE} = 250 \text{ V}$; $T_j = 150^{\circ}\text{C}$)	I_{CER}	< 50	μA
Collector cutoff current ($R_{BE} = 2.7 \text{ k}\Omega$, $V_{CE} = 250 \text{ V}$; $T_{amb} = 25^{\circ}\text{C}$)	I_{CER}	< 1	μA
Emitter cutoff current ($V_{EB} = 5 \text{ V}$)	I_{EBO}	< 10	μA
Collector-emitter saturation voltage ($I_C = 25 \text{ mA}$; $T_j = 150^{\circ}\text{C}$)	$V_{CEsatRF}$	20	V
Collector-emitter saturation voltage ($I_C = 10 \text{ mA}$; $I_B = 1 \text{ mA}$)			
Collector-base saturation voltage ($I_C = 10 \text{ mA}$; $I_B = 1 \text{ mA}$)	V_{CEsat}	< 0.5	V
	V_{BEsat}	< 1	V
DC current gain ($I_C = 25 \text{ mA}$; $V_{CE} = 20 \text{ V}$)	h_{FE}	> 50	—

Dynamic characteristics ($T_{amb} = 25^{\circ}\text{C}$)

Transition frequency ($V_{CE} = 10 \text{ V}$; $I_C = 10 \text{ mA}$)	f_T	> 60	MHz
Reverse transfer capacitance ($V_{CB} = 30 \text{ V}$)	C_{12e}	< 1.6	pF
Feedback time constant ($V_{CB} = 20 \text{ V}$; $-I_E = 10 \text{ mA}$; $f = 10.7 \text{ MHz}$)	r_{bb} , C_{bb}	< 70	ps

Total perm. power dissipation versus temperature
 $P_{tot} = f(T)$

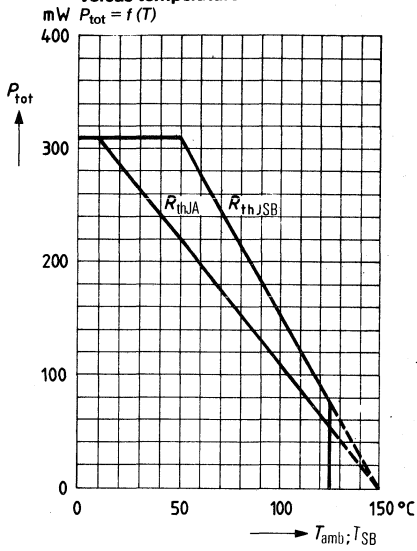

Perm. pulse load $\frac{r_{thJSB}}{R_{thJSB}} = f(t)$
 $D = \text{parameter}$

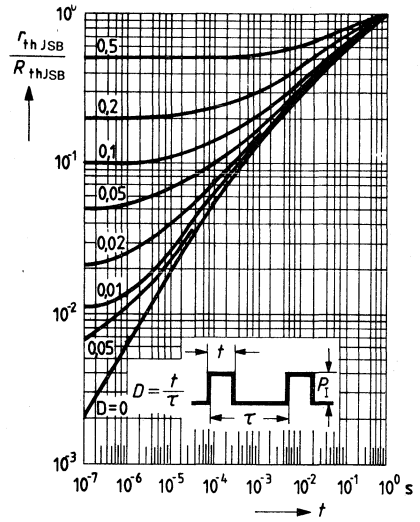

Collector current $I_C = f(V_{BE})$
 $V_{CE} = 10 \text{ V}; T_{case} = 25 \text{ }^\circ\text{C}$

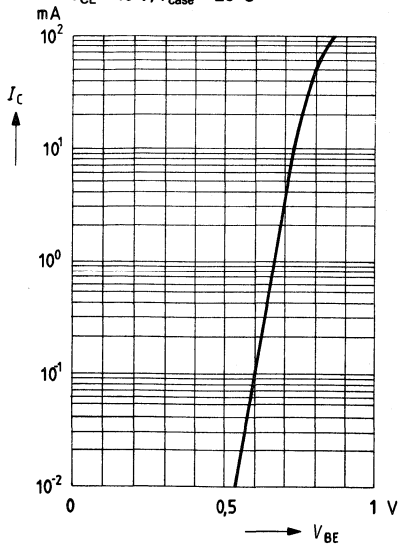

DC current gain $h_{FE} = f(I_C)$
 $V_{CE} = 10 \text{ V}; T_{case} = 25 \text{ }^\circ\text{C}$

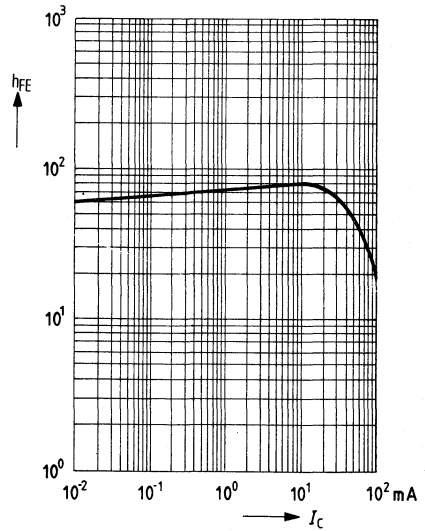

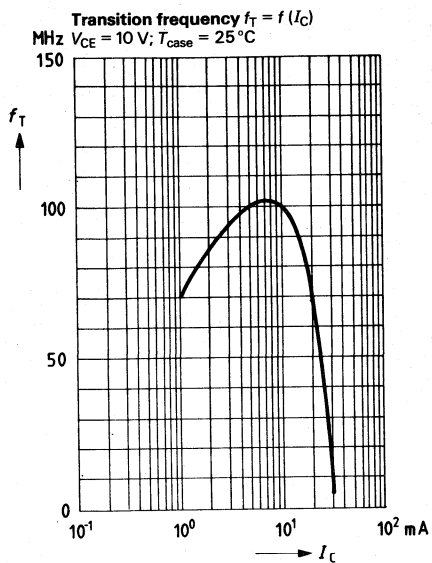

BFN 23 is an epitaxial PNP silicon planar transistor in TO 236 plastic package. (23 A 3 DIN 41869). It is the complementary type to BFN 22.

The transistor is particularly suitable for use in video B output stages of thin and thick film circuits. It is marked with the code letters "HC".

Type	Mark	Ordering code
BFN 23	HC	Q62702-F597

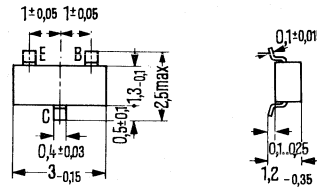

Approx. weight 0.02 g Dimensions in mm

Maximum ratings ($T_{amb} = 25^{\circ}\text{C}$)

Collector-base voltage	$-V_{CBO}$	250	V
Collector-emitter voltage	$-V_{CEO}$	250	V
Emitter-base voltage	$-V_{EBO}$	5	V
Collector current	$-I_C$	20	mA
Collector-peak current	$-I_{CM}$	50	mA
Junction temperature	T_j	150	$^{\circ}\text{C}$
Storage temperature range	T_{stg}	-65 to +125	$^{\circ}\text{C}$
Total power dissipation ($T_{SB} = 50^{\circ}\text{C}$) ¹⁾	P_{tot}	310	mW

Thermal resistance

Junction to ambient air	R_{thJA}	< 450	K/W
Junction to substrate back ¹⁾	R_{thJSB}	≤ 320	K/W

1) Ceramic substrate 0.7 mm; 2.5 cm² area.

Static characteristics ($T_{amb} = 25^{\circ}\text{C}$)

Collector-emitter breakdown voltage ($R_{BE} = 2.7\text{ k}\Omega$)	$-V_{(BR)CER}$	> 250	V
Collector-base breakdown voltage	$-V_{(BR)CBO}$	> 250	V
Collector-emitter breakdown voltage	$-V_{(BR)CEO}$	> 250	V
Emitter-base breakdown voltage	$-V_{(BR)EBO}$	> 5	V
Collector cutoff current ($-V_{CB} = 200\text{ V}$)	$-I_{CBO}$	< 10	nA
Collector cutoff current ($R_{BE} = 2.7\text{ k}\Omega$, $-V_{CE} = 250\text{ V}$; $T_j = 150^{\circ}\text{C}$)	$-I_{CER}$	< 50	μA
($R_{BE} = 2.7\text{ k}\Omega$, $-V_{CE} = 250\text{ V}$; $T_{amb} = 25^{\circ}\text{C}$)	$-I_{CER}$	< 1	μA
Emitter cutoff current ($-V_{BE} = 5\text{ V}$)	$-I_{EBO}$	< 10	μA
Collector-emitter saturation voltage ($-I_C = 25\text{ mA}$; $T_j = 150^{\circ}\text{C}$)	$-V_{CEsatRF}$	20	V
Collector-emitter saturation voltage ($-I_C = 10\text{ mA}$; $-I_B = 1\text{ mA}$)	$-V_{CEsat}$	< 0.5	V
Collector-base saturation voltage ($-I_C = 10\text{ mA}$)	$-V_{BEsat}$	< 1	V
DC current gain ($-I_C = 25\text{ mA}$; $-V_{CE} = 20\text{ V}$)	h_{FE}	> 50	-

Dynamic characteristics ($T_{amb} = 25^{\circ}\text{C}$)

Transition frequency ($-V_{CE} = 10\text{ V}$; $-I_C = 10\text{ mA}$)	f_T	> 60	MHz
Reverse transfer capacitance ($-V_{CB} = 30\text{ V}$)	C_{12e}	< 1.6	pF
Feedback time constant ($-V_{CB} = 20\text{ V}$; $I_E = 10\text{ mA}$; $f = 10.7\text{ MHz}$)	r_{bb} , C_{bb}	< 70	ps

Total perm. power dissipation versus temperature
 $P_{tot} = f(T)$

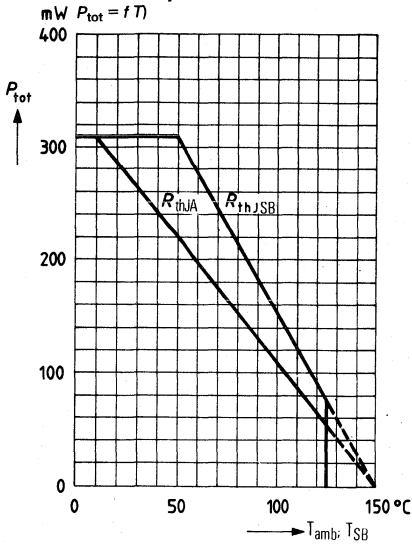

Perm. pulse load $r_{thJSB} = f(t)$
 $D = \text{parameter}$

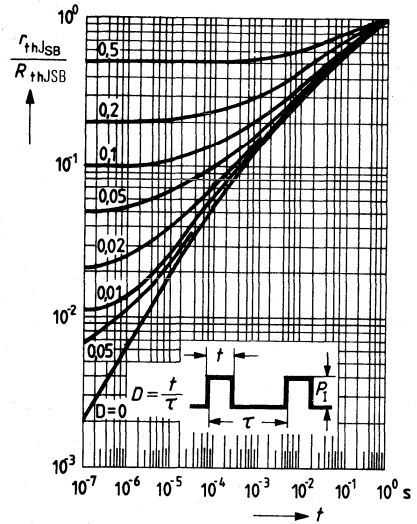

DC current gain $h_{FE} = f(I_C)$
 $-V_{CE} = 10 \text{ V}; T_{case} = 25^\circ\text{C}$

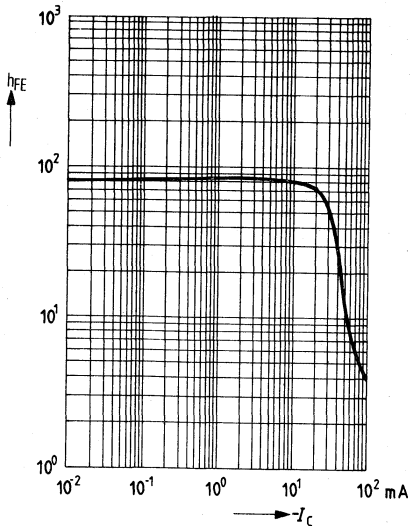

Transition frequency $f_T = f(I_C)$
 $-V_{CE} = 10 \text{ V}; T_{case} = 25^\circ\text{C}$

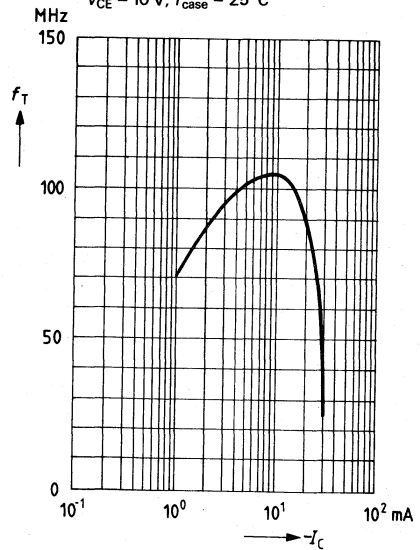

BFP 22 is an epitaxial NPN silicon planar transistor in TO 92 plastic package (10 A 3 DIN 41868). It is particularly suitable for use as amplifier and low-ohmic switching transistor at high operating voltages.

Type	Ordering code
BFP 22	Q62702-F621

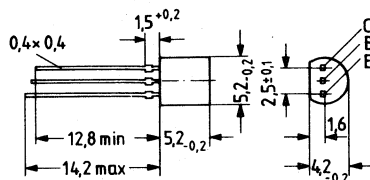

Mounting instruction.
Fixing hole dia 0.6
Approx. weight 0.25 g

Dimensions in mm

Maximum ratings

Collector-emitter voltage	V_{CEO}	200	V
Collector-base voltage	V_{CBO}	200	V
Emitter-base voltage	V_{EBO}	6	V
Collector current	I_C	500	mA
Junction temperature	T_j	150	°C
Storage temperature range	T_{stg}	-55 to +150	°C
Total power dissipation ($T_{amb} = 25^\circ\text{C}$)	P_{tot}	625	mW

Thermal resistance

Junction to ambient air ¹⁾	R_{thJA}	≤ 200	K/W
Junction to case	R_{thJC}	≤ 83	K/W

1) For fixing the transistor with max. 3 mm long leads on PCBs with a 10 mm² large copper area for the collector terminal.

Static characteristics ($T_{amb} = 25\text{ }^\circ\text{C}$)

- Collector-emitter breakdown voltage ($I_C = 1\text{ mA}$)
- Collector-base breakdown voltage ($I_C = 100\text{ }\mu\text{A}$)
- Emitter-base breakdown voltage ($I_E = 100\text{ }\mu\text{A}$)
- Collector cutoff current ($V_{CBO} = 160\text{ V}$)
- Emitter cutoff current ($V_{EBO} = 4\text{ V}$)
- Collector-emitter saturation voltage
 $I_C = 20\text{ mA}; I_B = 2\text{ mA}$
- Base-emitter saturation voltage
($I_C = 20\text{ mA}; I_B = 2\text{ mA}$)
- DC current gain
 $I_C = 1\text{ mA}; V_{CE} = 10\text{ V}$
 $I_C = 10\text{ mA}; V_{CE} = 10\text{ V}$
 $I_C = 30\text{ mA}; V_{CE} = 10\text{ V}$

$-V_{(BR)CEO}$	> 200	V
$V_{(BR)CBO}$	> 200	V
$V_{(BR)EBO}$	> 6	V
I_{CBO}	≤ 100	nA
I_{EBO}	≤ 100	nA
V_{CEsat}	< 0.4	V
V_{BEsat}	< 0.9	V
h_{FE}	> 25	-
h_{FE}	> 40	-
h_{FE}	> 50	-

Dynamic characteristics ($T_{amb} = 25\text{ }^\circ\text{C}$)

- Transition frequency ($V_{CE} = 10\text{ V}, I_C = 10\text{ mA}$)
- Output capacitance
($V_{CBO} = 20\text{ V}; f = 1\text{ MHz}$)

f_T	> 50	MHz
C_{CBO}	< 5	pF

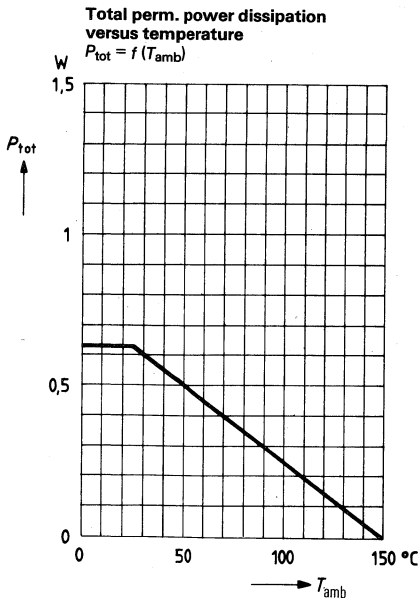

BFP 23 is an epitaxial PNP silicon planar transistor in TO 92 plastic package (10 A 3 DIN 41 868). It is particularly suitable for use as amplifier and low-ohmic switching transistor at high operating voltages.

Type	Ordering code
BFP 23	Q62702-F622

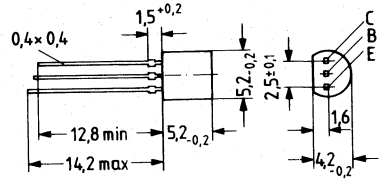

Mounting instruction:
Fixing hole dia 0.6
Approx. weight 0.25 g

Dimensions in mm

Maximum ratings

Collector-emitter voltage	$-V_{CE0}$	200	V
Collector-base voltage	$-V_{CB0}$	200	V
Emitter-base voltage	$-V_{EB0}$	5	V
Collector current	$-I_C$	500	mA
Junction temperature	T_j	150	$^{\circ}\text{C}$
Storage temperature range	T_{stg}	-55 to +150	$^{\circ}\text{C}$
Total power dissipation ($T_{amb} = 25^{\circ}\text{C}$)	P_{tot}	625	mW

$-V_{CE0}$	200	V
$-V_{CB0}$	200	V
$-V_{EB0}$	5	V
$-I_C$	500	mA
T_j	150	$^{\circ}\text{C}$
T_{stg}	-55 to +150	$^{\circ}\text{C}$
P_{tot}	625	mW

Thermal resistance

Junction to ambient air ¹⁾	R_{thJA}	≤ 200	K/W
Junction to case	R_{thJC}	≤ 83	K/W

R_{thJA}	≤ 200	K/W
R_{thJC}	≤ 83	K/W

1) For fixing the transistor with max. 3 mm long leads on PCBs with a 10 mm^2 large copper area for the collector terminal.

Static characteristics ($T_{amb} = 25^{\circ}\text{C}$)

- Collector-emitter breakdown voltage ($I_C = 1\text{ mA}$)
- Collector-base breakdown voltage ($I_C = 100\text{ }\mu\text{A}$)
- Emitter-base breakdown voltage ($I_E = 100\text{ }\mu\text{A}$)
- Collector cutoff current ($-V_{CBO} = 160\text{ V}$)
- Emitter cutoff current ($-V_{EBO} = 4\text{ V}$)
- Collector-emitter saturation voltage
 $-I_C = 20\text{ mA}; -I_B = 2\text{ mA}$
- Base-emitter saturation voltage
 $(-I_C = 20\text{ mA}; -I_B = 2\text{ mA})$
- DC current gain
- $-I_C = 1\text{ mA}; -V_{CE} = 10\text{ V}$
- $-I_C = 10\text{ mA}; -V_{CE} = 10\text{ V}$
- $-I_C = 30\text{ mA}; -V_{CE} = 10\text{ V}$

$-V_{(BR)CER}$	> 200	V
$-V_{(BR)CBO}$	> 200	V
$-V_{(BR)EBO}$	> 5	V
$-I_{CBO}$	≤ 100	nA
$-I_{EBO}$	≤ 100	nA
$-V_{CEsat}$	0.4	V
$-V_{BEsat}$	0.9	V
h_{FE}	> 25	-
h_{FE}	> 40	-
h_{FE}	> 30	-

Dynamic characteristics ($T_{amb} = 25^{\circ}\text{C}$)

- Transition frequency ($-V_{CE} = 10\text{ V}, -I_C = 10\text{ mA}$)
- Output capacitance
 $(V_{CBO} = 20\text{ V}; f = 1\text{ MHz})$

f_T	> 50	MHz
C_{CBO}	< 5	pF

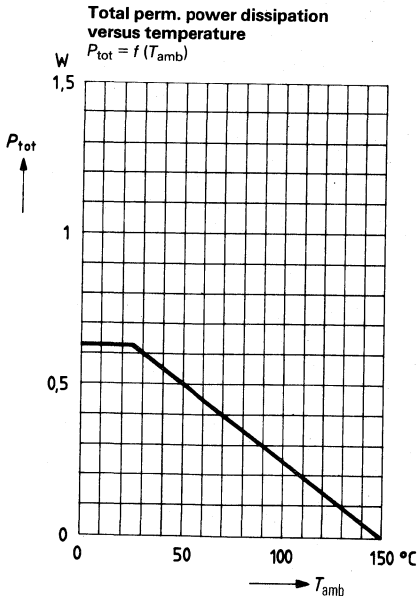

BFQ 17 is an epitaxial NPN silicon planar RF transistor in SOT 89 plastic package intended for use up to the GHz range

This transistor is particularly suitable for use in film circuits. It is marked with the code letters "FA".

Type	Mark	Ordering code
BFQ 17	FA	Q62702-F526

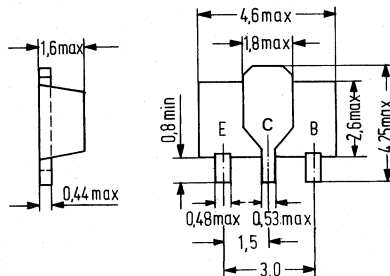

Approx. weight 0.1 g Dimensions in mm

Maximum ratings ($T_{amb} = 25^{\circ}\text{C}$)

Collector-base voltage	V_{CBO}	40	V
Collector-emitter voltage ($R_{BE} \leq 50\Omega$)	V_{CER}	40	V
Collector-emitter voltage	V_{CEO}	25	V
Emitter-base voltage	V_{EBO}	2	V
Collector current	I_C	150	mA
Collector peak current ($f \geq 1\text{ MHz}$)	I_{CM}	300	mA
Junction temperature	T_j	150	$^{\circ}\text{C}$
Storage temperature range	$T_{stg}^{1)}$	-55 to +125	$^{\circ}\text{C}$
Total power dissipation ($T_{SB}^{2)}) = 60^{\circ}\text{C}$)	P_{tot}	1.5	W

V_{CBO}	40	V
V_{CER}	40	V
V_{CEO}	25	V
V_{EBO}	2	V
I_C	150	mA
I_{CM}	300	mA
T_j	150	$^{\circ}\text{C}$
$T_{stg}^{1)}$	-55 to +125	$^{\circ}\text{C}$
P_{tot}	1.5	W

Thermal resistance

Junction to ambient air	R_{thJA}	155	K/W
Junction to substrate back ¹⁾	R_{thJSB}	60	K/W

R_{thJA}	155	K/W
R_{thJSB}	60	K/W

1) Ceramic substrate 0.7 mm with 2.5 cm² area.
2) T_{SB} = temperature substrate back

Static characteristics ($T_{\text{amb}} = 25^{\circ}\text{C}$)

Collector cutoff current

($V_{\text{CBO}} = 20 \text{ V}$; $T_{\text{amb}} = 125^{\circ}\text{C}$) $I_{\text{CBO}} \leq 20 \mu\text{A}$ Collector-emitter saturation voltage¹⁾($I_{\text{C}} = 100 \text{ mA}$) $V_{\text{CEsat}} \leq 0.75 \text{ V}$

DC current gain

($I_{\text{C}} = 50 \text{ mA}$; $V_{\text{CE}} = 5 \text{ V}$) $h_{\text{FE}} \geq 25$ ($I_{\text{C}} = 150 \text{ mA}$; $V_{\text{CE}} = 5 \text{ V}$) $h_{\text{FE}} \geq 25$ **Dynamic characteristics** ($T_{\text{amb}} = 25^{\circ}\text{C}$)

Transition frequency

($I_{\text{C}} = 150 \text{ mA}$; $V_{\text{CE}} = 15 \text{ V}$; $f = 500 \text{ MHz}$) $f_{\text{T}} 1.2 \text{ GHz}$

Power gain

($I_{\text{C}} = 70 \text{ mA}$; $V_{\text{CE}} = 18 \text{ V}$; $f = 200 \text{ MHz}$; $R_{\text{g}} = 60 \Omega$) $G_{\text{pe}} 16 \text{ dB}$ ($I_{\text{C}} = 70 \text{ mA}$; $V_{\text{CE}} = 18 \text{ V}$; $f = 800 \text{ MHz}$; $R_{\text{g}} = 60 \Omega$) $G_{\text{pe}} 6.5 \text{ dB}$

Noise figure

($I_{\text{C}} = 30 \text{ mA}$; $V_{\text{CE}} = 15 \text{ V}$; $f = 200 \text{ MHz}$; $R_{\text{g}} = 60 \Omega$) $NF \leq 6 \text{ dB}$

Collector-base capacitance

($V_{\text{CBO}} = 15 \text{ V}$; $f = 1 \text{ MHz}$) $C_{\text{CBO}} \leq 4 \text{ pF}$

Reverse transfer capacitance

($I_{\text{C}} = 10 \text{ mA}$; $V_{\text{CE}} = 15 \text{ V}$; $f = 1 \text{ MHz}$) $C_{12e} 1.7 \text{ pF}$ Output voltage²⁾($I_{\text{C}} = 70 \text{ mA}$; $V_{\text{CE}} = 18 \text{ V}$; $R_{\text{g}} = R_{\text{L}} = 75 \Omega$;
 $d_{\text{IM}} = 60 \text{ dB}$) $V_{\text{O}} 600 \text{ mV}$

1) Applicable to that characteristic passing through $I_{\text{C}} = 110 \text{ mA}$, $V_{\text{CE}} = 1 \text{ V}$ at constant I_{B} .
 2) Measured with three tone modulation f approx. 800 MHz

S parameterOperating point: $V_{CE} = 10 \text{ V}$, $I_C = 50 \text{ mA}$, $Z_o = 50 \Omega$

f (GHz)	S_{11}	φ	S_{21}	φ	S_{12}	φ	S_{22}	φ
0,1	0,650	-172	10,25	93	0,025	64	0,246	- 50
0,2	0,659	177	5,26	82	0,045	74	0,205	- 51
0,3	0,673	172	3,53	76	0,066	78	0,215	- 57
0,4	0,685	169	2,64	70	0,085	81	0,233	- 62
0,5	0,693	167	2,09	65	0,105	83	0,249	- 68
0,6	0,693	164	1,78	60	0,126	84	0,276	- 76
0,7	0,684	162	1,51	56	0,148	85	0,311	- 80
0,8	0,701	159	1,32	52	0,171	86	0,336	- 85
0,9	0,701	159	1,18	50	0,195	87	0,368	- 89
1,0	0,701	158	1,07	48	0,221	87	0,389	- 92
1,1	0,691	156	0,98	47	0,257	88	0,419	- 96
1,2	0,674	154	0,90	46	0,285	88	0,439	- 99
1,3	0,650	153	0,84	44	0,315	88	0,467	-102
1,4	0,642	148	0,79	42	0,349	86	0,479	-102
1,5	0,609	145	0,77	42	0,386	84	0,495	-105
1,6	0,583	138	0,74	42	0,427	82	0,517	-108
1,7	0,561	131	0,72	41	0,466	80	0,537	-109
1,8	0,539	121	0,70	41	0,491	77	0,557	-109
1,9	0,517	111	0,68	40	0,525	73	0,551	-111
2,0	0,531	100	0,67	40	0,548	70	0,567	-112

Total perm. power dissipation versus temperature
 $P_{tot} = f(T)$

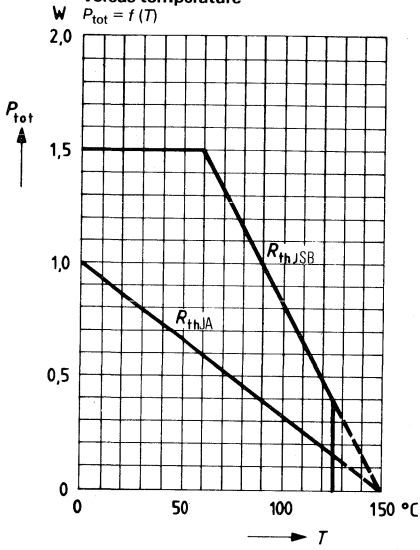

Perm. pulse load
 $r_{thJSB} = f(t); = \text{parameter}$

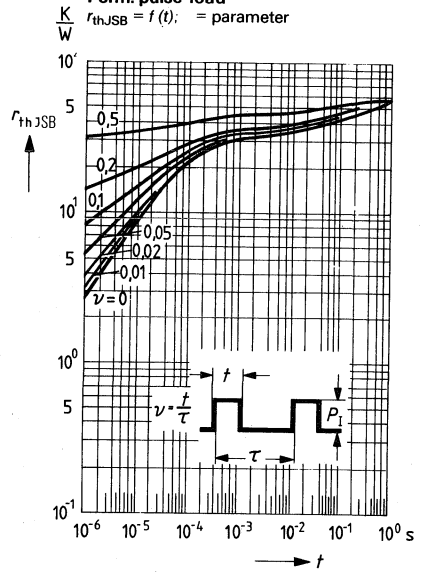

Transition frequency $f_T = f(I_C)$
 $V_{CE} = 15 \text{ V}, f = 500 \text{ MHz}, T_{amb} = 25 \text{ °C}$

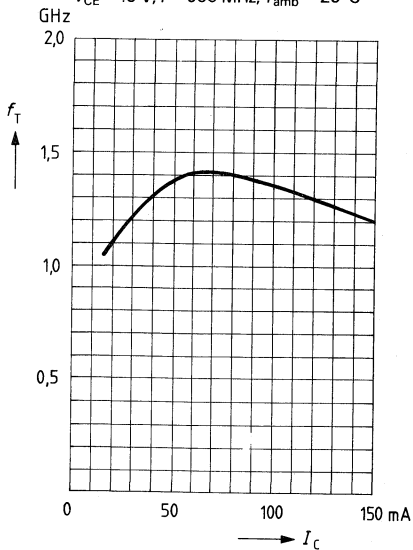

BFQ 19 is an epitaxial NPN silicon planar RF transistor in SOT 89 plastic package, intended for use in broadband and antenna amplifiers up to the GHz range.

This transistor is particularly suitable for use in film circuits. It is marked with the code letters "FB".

Type	Mark	Ordering code
BFQ 19	FB	Q62702-F575

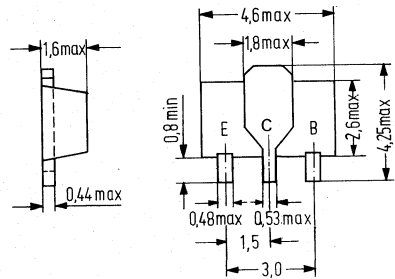

Approx. weight 0.1 g Dimensions in mm

Maximum ratings ($T_{amb} = 25^\circ\text{C}$)

Collector-base voltage	V_{CBO}	20	V
Collector-emitter voltage	V_{CEO}	15	V
Emitter-base voltage	V_{EBO}	2	V
Collector current	I_C	75	mA
Collector peak current ($f \geq 1$ MHz)	I_{CM}	150	mA
Junction temperature	T_j	150	°C
Storage temperature range	$T_{stg.}^{1)}$	-55 to +125	°C
Total power dissipation ($T_{SB}^{2)} = 100$ °C)	$P_{tot}^{1)}$	550	mW

Thermal resistance

Junction to ambient air	R_{thJA}	200	K/W
Junction to substrate back ¹⁾	R_{thJSB}	90	K/W

1) Ceramic substrate 0.7 mm thick with 2.5 cm² area.
 2) T_{SB} = temperature substrate back

Static characteristics ($T_{amb} = 25^{\circ}\text{C}$)

Collector cutoff current ($V_{CBO} = 10\text{ V}$)	I_{CBO}	≤ 100	nA
DC current gain ($I_C = 50\text{ mA}$; $V_{CE} = 10\text{ V}$)	h_{FE}	50	-

Dynamic characteristics ($T_{amb} = 25^{\circ}\text{C}$)

Transition frequency ($I_C = 50\text{ mA}$; $V_{CE} = 10\text{ V}$; $f = 500\text{ MHz}$)	f_T	5	GHz
Noise figure ($I_C = 60\text{ mA}$; $V_{CE} = 8\text{ V}$; $f = 800\text{ MHz}$; $R_g = 60\ \Omega$)	NF	4.5	dB
Power gain $I_C = 60\text{ mA}$; $V_{CE} = 8\text{ V}$; $f = 800\text{ MHz}$; $R_g = 60\ \Omega$)	G_{pe}	9	dB
Collector-base capacitance ($V_{CBO} = 10\text{ V}$; $f = 1\text{ MHz}$)	C_{CBO}	1.3	pF
Reverse transfer capacitance ($I_C = 1\text{ mA}$; $V_{CE} = 10\text{ V}$; $f = 1\text{ MHz}$)	C_{12e}	0.9	pF
Output voltage ¹⁾ ($I_C = 60\text{ mA}$; $V_{CE} = 8\text{ V}$; $R_g = R_L = 75\ \Omega$; $d_{IM} = 60\text{ dB}$)	V_O	650	mV

S parameter

Operating point: $V_{CE} = 8\text{ V}$; $I_C = 60\text{ mA}$; $Z_o = 50\ \Omega$

f (GHz)	S_{11}	φ	S_{21}	φ	S_{12}	φ	S_{22}	φ
0,1	0,287	-163	19,91	102	0,026	79	0,322	-51
0,2	0,297	-179	10,32	92	0,052	79	0,203	-47
0,3	0,314	172	6,92	86	0,076	80	0,165	-48
0,4	0,327	167	5,25	83	0,101	80	0,162	-52
0,5	0,334	162	4,22	80	0,125	80	0,180	-53
0,6	0,347	159	3,53	77	0,148	79	0,173	-49
0,7	0,352	156	3,06	74	0,172	79	0,161	-53
0,8	0,360	155	2,68	72	0,193	79	0,163	-56
0,9	0,346	154	2,40	69	0,214	77	0,179	-54
1,0	0,354	152	2,20	67	0,233	77	0,172	-54
1,1	0,347	152	2,05	65	0,260	77	0,191	-54
1,2	0,331	152	1,91	64	0,280	77	0,202	-48
1,3	0,286	151	1,77	61	0,299	76	0,220	-50
1,4	0,273	144	1,66	58	0,321	75	0,241	-46
1,5	0,231	142	1,60	56	0,341	72	0,255	-48
1,6	0,205	132	1,54	54	0,366	71	0,299	-47
1,7	0,167	121	1,48	51	0,390	70	0,316	-48
1,8	0,162	95	1,43	49	0,408	69	0,370	-49
1,9	0,167	80	1,36	47	0,421	67	0,377	-49
2,0	0,191	58	1,30	45	0,435	66	0,423	-54

1) Measured with three tone modulation $f = \text{approx. } 800\text{ MHz}$.

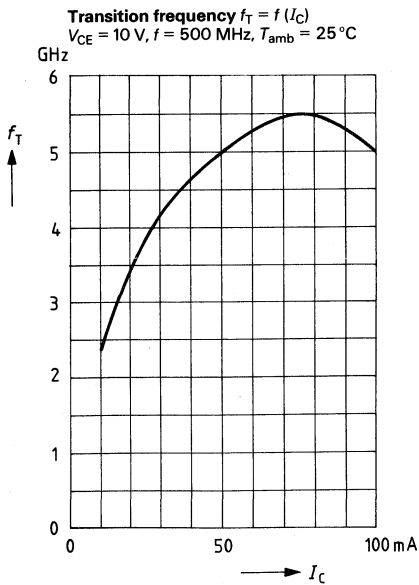
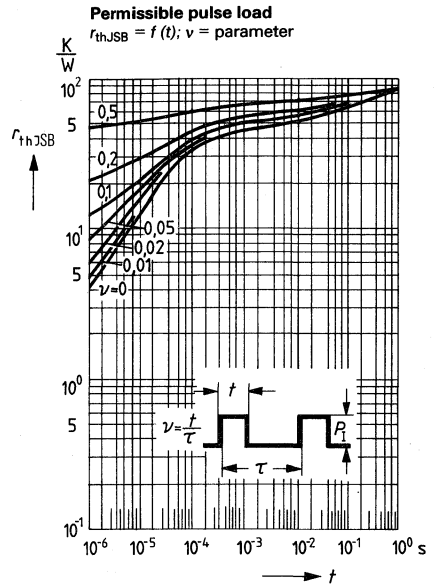
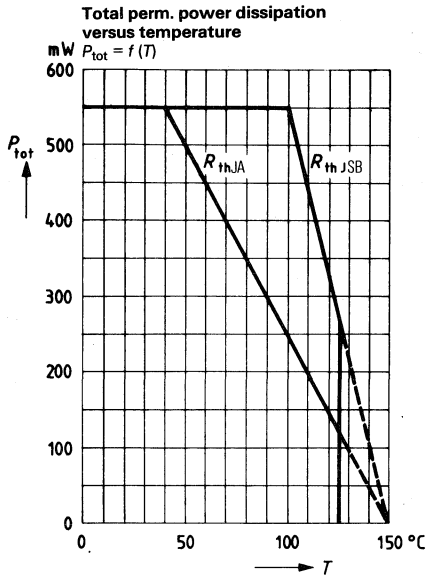

Low Noise NPN Silicon Microwave Transistor up to 4 GHz

BFQ 28

BFQ 28 is a bipolar silicon NPN microwave transistor in hermetically sealed metal ceramic 100 mil package similar to TO 120. State-of-the-art manufacturing methods such as ion implantation technique, titanium-platinum-gold metallization as well as a glass-passivated chip surface ensure very high reliability. The transistor is particularly suitable for low noise amplifiers and oscillators up to 4 GHz. It is marked on its package with the short designation "28".

Type	Mark	Ordering code
BFQ 28	28	Q62702-F527

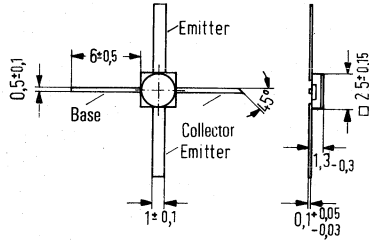

Approx. weight 0.05 g

Dimensions in mm

Maximum ratings ($T_{amb} = 25^{\circ}\text{C}$)

Collector-emitter voltage	V_{CEO}	15	V
Collector-emitter voltage	V_{CES}	20	V
Collector-base voltage	V_{CBO}	20	V
Emitter-base voltage	V_{EBO}	1.5	V
Collector current	I_C	15	mA
Collector-peak current ($t \leq 10 \mu\text{sec}$)	I_{CM}	20	mA
Storage temperature range	T_{stg}	-65 to +175	$^{\circ}\text{C}$
Junction temperature	T_j	200	$^{\circ}\text{C}$
Total power dissipation ($T_{amb} = 150^{\circ}\text{C}$)	P_{tot}	200	mW

Thermal resistance

Junction to ambient air (when mounted on AL_2O_3 ceramics 16x25x0.6mm or glass-fiber reinforced Teflon 40x25x1.5 mm)	R_{thJA}	≤ 250	K/W
--	------------	------------	-----

Static characteristics ($T_{amb} = 25^{\circ}\text{C}$)

Collector cutoff current ($V_{CBO} = 10\text{ V}$)	I_{CBO}	≤ 1	μA
Collector-emitter breakdown voltage ($I_C = 1\text{ mA}$)	$V_{(BR)CEO}$	≥ 15	V
Collector-base breakdown voltage ($I_C = 0.1\text{ mA}$)	$V_{(BR)CBO}$	≥ 20	V
Emitter-base breakdown voltage ($I_E = 0.1\text{ mA}$)	$V_{(BR)EBO}$	≥ 1.5	V
DC current gain ($I_C = 10\text{ mA}$; $V_{CE} = 10\text{ V}$)	h_{FE}	≥ 20	-

Dynamic characteristics ($T_{amb} = 25^{\circ}\text{C}$)

Transition frequency ($I_C = 10\text{ mA}$; $V_{CE} = 10\text{ V}$; $f = 200\text{ MHz}$)	f_T	$5 > 4.5$	GHz
Small signal current gain ($I_C = 10\text{ mA}$; $V_{CE} = 10\text{ V}$; $f = 1\text{ kHz}$)	h_{fe}	60	-
Reverse transfer capacitance ($I_C = 1\text{ mA}$; $V_{CE} = 10\text{ V}$; $f = 1\text{ MHz}$)	C_{12e}	0.25	pF
Noise figure ($I_C = 3\text{ mA}$; $V_{CE} = 10\text{ V}$; $f = 2\text{ GHz}$; $Z_G = Z_{G\text{opt}}$)	NF_{min}	3	dB
Power gain ($I_C = 15\text{ mA}$; $V_{CE} = 10\text{ V}$; $f = 2\text{ GHz}$; $Z_L = Z_{L\text{opt}}$; $Z_G = Z_{G\text{opt}}$)	$G_{pe\text{opt}}$	14	dB
Insertion gain ($I_C = 10\text{ mA}$; $V_{CE} = 10\text{ V}$; $f = 2\text{ GHz}$; $Z_G = Z_L = 50\ \Omega$)	$ S_{21e} ^2$	9.5 (> 8)	dB

S parameterOperating point: $V_{CE} = 10 \text{ V}$, $I_C = 3 \text{ mA}$, $Z_o = 50 \Omega$

f (GHz)	S_{11}	φ	S_{21}	φ	S_{12}	φ	S_{22}	φ
0,1	0,869	- 15	8,18	166	0,010	77	0,999	- 4
0,2	0,812	- 31	7,80	153	0,016	71	0,989	- 10
0,3	0,807	- 46	7,41	143	0,025	61	0,928	- 16
0,4	0,784	- 57	6,38	134	0,031	55	0,896	- 17
0,5	0,715	- 71	6,28	125	0,034	49	0,853	- 20
0,6	0,673	- 83	5,95	117	0,038	46	0,835	- 23
0,7	0,627	- 92	5,59	110	0,042	42	0,843	- 25
0,8	0,586	-104	5,17	104	0,044	41	0,803	- 26
0,9	0,565	-113	4,80	98	0,045	38	0,777	- 28
1,0	0,533	-123	4,43	93	0,047	37	0,774	- 30
1,1	0,532	-132	4,07	88	0,049	35	0,740	- 31
1,2	0,518	-137	3,80	83	0,049	38	0,721	- 35
1,3	0,498	-146	3,55	79	0,049	32	0,728	- 36
1,4	0,496	-151	3,34	74	0,051	32	0,716	- 37
1,5	0,464	-159	3,15	70	0,043	32	0,701	- 38
1,6	0,475	-164	3,00	68	0,050	34	0,704	- 42
1,7	0,470	-168	2,83	67	0,051	33	0,727	- 43
1,8	0,481	-173	2,69	60	0,053	33	0,712	- 43
1,9	0,468	-177	2,57	56	0,053	34	0,694	- 46
2,0	0,458	175	2,45	53	0,055	34	0,699	- 50
2,5	0,490	160	2,04	37	0,061	38	0,678	- 60
3,0	0,493	145	1,75	23	0,072	42	0,686	- 71
3,5	0,534	130	1,52	9	0,088	43	0,668	- 86
4,0	0,541	118	1,32	-4	0,105	41	0,690	- 99
4,5	0,575	103	1,18	-17	0,127	36	0,678	-115
5,0	0,609	95	1,01	-31	0,147	32	0,698	-133
5,5	0,635	84	0,87	-43	0,169	25	0,719	-148
6,0	0,658	80	0,74	-56	0,183	16	0,737	-168

S parameterOperating point: $V_{CE} = 10 \text{ V}$, $I_C = 5 \text{ mA}$, $Z_o = 50 \Omega$

f (GHz)	S_{11}	φ	S_{21}	φ	S_{12}	φ	S_{22}	φ
0,1	0,809	- 20	12,28	163	0,009	72	0,992	- 6
0,2	0,760	- 42	11,55	147	0,018	66	0,932	- 12
0,3	0,710	- 60	10,43	135	0,022	58	0,886	- 17
0,4	0,653	- 76	9,30	125	0,026	53	0,841	- 19
0,5	0,602	- 89	8,24	116	0,029	48	0,801	- 21
0,6	0,558	-103	7,52	108	0,031	45	0,774	- 23
0,7	0,520	-112	6,81	101	0,034	42	0,781	- 24
0,8	0,496	-124	6,23	95	0,036	42	0,750	- 25
0,9	0,478	-133	5,66	90	0,038	42	0,728	- 27
1,0	0,455	-142	5,14	86	0,038	42	0,724	- 29
1,1	0,468	-150	4,70	81	0,040	40	0,697	- 29
1,2	0,455	-155	4,35	77	0,040	41	0,682	- 34
1,3	0,445	-163	4,02	73	0,041	41	0,688	- 35
1,4	0,450	-166	3,75	69	0,044	41	0,678	- 36
1,5	0,421	-175	3,52	65	0,043	42	0,669	- 37
1,6	0,440	-178	3,35	63	0,045	44	0,673	- 40
1,7	0,439	176	3,16	60	0,047	44	0,698	- 41
1,8	0,450	173	2,99	56	0,048	44	0,682	- 42
1,9	0,441	170	2,85	53	0,050	45	0,666	- 44
2,0	0,449	165	2,71	51	0,052	46	0,665	- 46
2,5	0,476	151	2,24	35	0,063	47	0,653	- 58
3,0	0,485	139	1,92	22	0,077	48	0,660	- 67
3,5	0,531	125	1,67	7	0,095	47	0,644	- 85
4,0	0,536	114	1,44	-6	0,111	43	0,668	- 98
4,5	0,578	100	1,28	-18	0,134	38	0,658	-113
5,0	0,611	93	1,11	-32	0,155	33	0,681	-131
5,5	0,632	82	0,96	-44	0,177	25	0,702	-146
6,0	0,652	78	0,81	-57	0,189	16	0,720	-167

S parameterOperating point: $V_{CE} = 10 \text{ V}$, $I_C = 10 \text{ mA}$, $Z_o = 50 \Omega$

f (GHz)	S_{11}	φ	S_{21}	φ	S_{12}	φ	S_{22}	φ
0,1	0,680	- 33	19,52	156	0,007	72	0,971	- 8
0,2	0,613	- 64	17,02	136	0,013	59	0,877	- 14
0,3	0,550	- 87	14,13	123	0,017	53	0,815	- 17
0,4	0,507	-105	11,70	112	0,020	48	0,774	- 19
0,5	0,475	-119	9,92	104	0,021	49	0,741	- 20
0,6	0,456	-132	8,68	97	0,024	48	0,722	- 21
0,7	0,436	-141	7,68	92	0,026	50	0,734	- 22
0,8	0,434	-151	6,82	86	0,028	50	0,707	- 23
0,9	0,426	-158	6,15	82	0,029	50	0,694	- 25
1,0	0,432	-167	5,54	79	0,031	52	0,693	- 26
1,1	0,435	-171	5,01	74	0,033	51	0,672	- 27
1,2	0,429	-175	4,61	71	0,034	53	0,656	- 31
1,3	0,434	177	4,25	67	0,036	54	0,671	- 32
1,4	0,435	176	3,96	63	0,038	52	0,662	- 33
1,5	0,421	168	3,71	60	0,038	55	0,656	- 35
1,6	0,435	166	3,51	58	0,041	56	0,659	- 38
1,7	0,439	162	3,30	55	0,044	56	0,683	- 39
1,8	0,456	160	3,13	51	0,046	56	0,676	- 40
1,9	0,441	157	2,97	49	0,048	56	0,655	- 43
2,0	0,454	154	2,82	47	0,051	56	0,656	- 44
2,5	0,485	143	2,32	31	0,064	56	0,645	- 56
3,0	0,496	132	1,98	19	0,079	55	0,656	- 68
3,5	0,548	120	1,72	5	0,100	52	0,642	- 83
4,0	0,553	109	1,48	-8	0,118	47	0,671	- 97
4,5	0,596	96	1,32	-20	0,142	40	0,660	-112
5,0	0,630	89	1,14	-34	0,164	34	0,681	-127
5,5	0,653	79	0,98	-46	0,185	27	0,700	-145
6,0	0,671	75	0,83	-59	0,198	18	0,720	-166

S parameterOperating point: $V_{CE} = 10 \text{ V}$, $I_C = 15 \text{ mA}$, $Z_o = 50 \Omega$

f (GHz)	S_{11}	φ	S_{21}	φ	S_{12}	φ	S_{22}	φ
0,1	0,583	- 46	23,55	150	0,007	63	0,946	- 9
0,2	0,527	- 83	18,70	128	0,012	56	0,843	- 14
0,3	0,487	-109	14,67	115	0,016	51	0,791	- 16
0,4	0,464	-126	11,71	105	0,016	53	0,756	- 17
0,5	0,451	-138	9,75	98	0,017	50	0,734	- 18
0,6	0,442	-149	8,39	92	0,020	49	0,718	- 19
0,7	0,431	-157	7,41	87	0,022	54	0,738	- 20
0,8	0,441	-166	6,56	82	0,024	55	0,715	- 21
0,9	0,436	-171	5,88	79	0,027	58	0,703	- 23
1,0	0,447	-178	5,26	75	0,028	57	0,705	- 24
1,1	0,457	178	4,76	71	0,030	57	0,685	- 25
1,2	0,449	174	4,38	68	0,031	59	0,668	- 30
1,3	0,457	168	4,02	64	0,033	60	0,685	- 31
1,4	0,455	168	3,75	61	0,036	58	0,677	- 32
1,5	0,446	160	3,51	58	0,035	61	0,671	- 33
1,6	0,464	159	3,32	56	0,039	61	0,674	- 37
1,7	0,467	155	3,12	53	0,042	62	0,701	- 38
1,8	0,480	154	2,95	49	0,044	62	0,692	- 39
1,9	0,468	151	2,80	46	0,046	61	0,673	- 42
2,0	0,481	149	2,68	44	0,049	62	0,674	- 43
2,5	0,512	139	2,21	29	0,064	61	0,663	- 56
3,0	0,521	128	1,87	17	0,081	60	0,677	- 67
3,5	0,574	117	1,62	3	0,101	56	0,663	- 83
4,0	0,581	106	1,39	-10	0,121	50	0,687	- 96
4,5	0,622	94	1,23	-22	0,146	43	0,676	-112
5,0	0,655	87	1,06	-36	0,169	37	0,697	-130
5,5	0,673	77	0,91	-48	0,191	28	0,716	-146
6,0	0,690	73	0,77	-60	0,205	19	0,734	-166

Total perm. power dissipation versus temperature

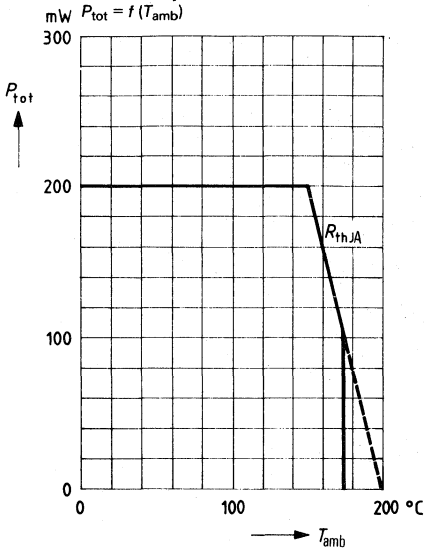

Gain at noise matching

$G_p = f(I_C); NF_{\text{min}} = f(I_C)$
 $V_{\text{CE}} = 10 \text{ V}; f = 2 \text{ GHz}$

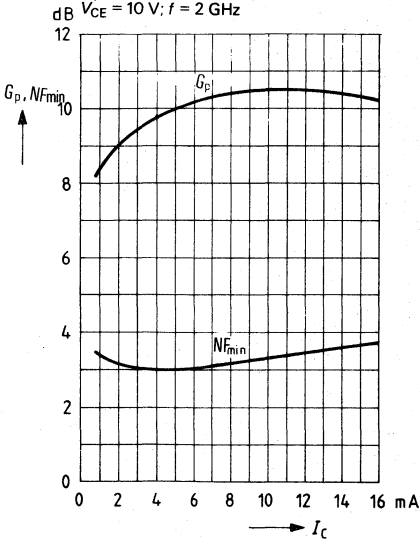

Insertion gain

$|S_{21e}|^2 = f(I_C); V_{\text{CE}} = \text{parameter};$
 $Z_G = Z_L = 50 \Omega; f = 2 \text{ GHz}$

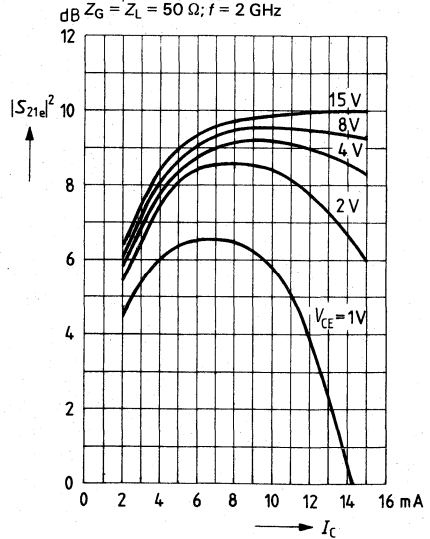

Extremely Low-Noise NPN Silicon RF Broadband Transistor BFQ 29

BFQ 29 is an extremely low noise epitaxial NPN silicon planar RF transistor in TO 236 plastic package (23 A 3 DIN 41869), intended for use in input stages and broadband amplifiers. The transistor is particularly suitable for use in film circuits up to the GHz range. The transistor is marked with the code letters "KB".

Type	Mark	Ordering code
BFQ 29	KB	Q62702-F515

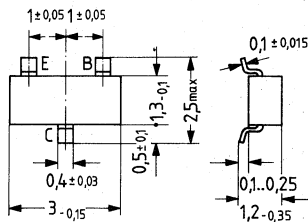

Approx. weight 0.02 g

Dimensions in mm

Maximum ratings ($T_{amb} = 25^\circ\text{C}$)

Collector-emitter voltage	V_{CE0}	15	V
Collector base voltage	V_{CB0}	20	V
Emitter-base voltage	V_{EB0}	2.5	V
Collector current	I_C	30	mA
Base current	I_B	4	mA
Junction temperature	T_j	150	$^\circ\text{C}$
Storage temperature range	T_{stg}	-65 to +125	$^\circ\text{C}$
Total power dissipation ($T_{amb} \leq 50^\circ\text{C}$)	P_{tot}	200	mW

V_{CE0}	15	V
V_{CB0}	20	V
V_{EB0}	2.5	V
I_C	30	mA
I_B	4	mA
T_j	150	$^\circ\text{C}$
T_{stg}	-65 to +125	$^\circ\text{C}$
P_{tot}	200	mW

Thermal resistance

Junction to ambient air	R_{thJA}	≤ 500	K/W
Junction to substrate back ¹⁾	R_{thJSB}	≤ 400	K/W

R_{thJA}	≤ 500	K/W
R_{thJSB}	≤ 400	K/W

1) Ceramic substrate 0.7 mm, 2.5 cm² area.

Static characteristics ($T_{\text{amb}} = 25^{\circ}\text{C}$)

Collector-emitter breakdown voltage ($I_{\text{CEO}} = 500 \mu\text{A}$)	$V_{(\text{BR})\text{CEO}}$	> 15	V
Collector-emitter breakdown voltage ($I_{\text{CBO}} = 100 \mu\text{A}$)	$V_{(\text{BR})\text{CES}}$	> 20	V
Emitter-base breakdown voltage ($I_{\text{EBO}} = 100 \mu\text{A}$)	$V_{(\text{BR})\text{EBO}}$	> 2.5	V
Collector cutoff current ($V_{\text{CBO}} = 10 \text{ V}$)	I_{CBO}	< 50	nA
DC current gain ($I_{\text{C}} = 10 \text{ mA}$; $V_{\text{CE}} = 6 \text{ V}$)	h_{FE}	≥ 30	–

Dynamic characteristics ($T_{\text{amb}} = 25^{\circ}\text{C}$)

Small signal current gain ($I_{\text{C}} = 10 \text{ mA}$; $V_{\text{CE}} = 6 \text{ V}$; $f = 1 \text{ kHz}$)	h_{fe}	$70 (> 30)$	–
Transition frequency ($I_{\text{C}} = 20 \text{ mA}$; $V_{\text{CE}} = 6 \text{ V}$; $f = 200 \text{ MHz}$)	f_{T}	$4 > 3.6$	GHz
Reverse transfer capacitance ($I_{\text{C}} = 1 \text{ mA}$; $V_{\text{CE}} = 6 \text{ V}$; $f = 1 \text{ MHz}$)	$C_{12\text{e}}$	0.6	pF
Noise figure ($I_{\text{C}} = 3 \text{ mA}$; $V_{\text{CE}} = 6 \text{ V}$; $f = 10 \text{ MHz}$; $R_{\text{g}} = 75 \Omega$)	NF	≤ 1.2	dB
($I_{\text{C}} = 4 \text{ mA}$; $V_{\text{CE}} = 6 \text{ V}$; $f = 800 \text{ MHz}$; $R_{\text{g}} = 60 \Omega$)	NF	2.1	dB
Output voltage ¹⁾ ($I_{\text{C}} = 20 \text{ mA}$; $V_{\text{CE}} = 6 \text{ V}$; $R_{\text{g}} = R_{\text{L}} = 75 \Omega$; $d_{\text{IM}} = 60 \text{ dB}$)	V_{O}	240	mV

1) Three tone modulation f approx. 800 MHz

S parameter:

Operating point: $V_{CE} = 10\text{ V}$; $I_C = 3\text{ mA}$; $Z_o = 50\ \Omega$

f (GHz)	S_{11}	φ	S_{21}	φ	S_{12}	φ	S_{22}	φ
0,2	0,778	- 49	6,991	138	0,048	61	0,875	-19
0,4	0,590	- 89	5,210	112	0,071	49	0,740	-26
0,6	0,468	-117	3,971	96	0,082	47	0,637	-28
0,8	0,405	-137	3,114	82	0,091	45	0,601	-30
1	0,361	-155	2,619	73	0,102	47	0,572	-33
1,2	0,336	-172	2,266	67	0,111	51	0,564	-35
1,4	0,331	169	1,983	56	0,125	51	0,537	-37
1,6	0,345	156	1,844	50	0,144	53	0,545	-42
1,8	0,347	145	1,604	43	0,158	53	0,543	-46
2	0,377	136	1,454	36	0,179	52	0,552	-52

Operating point: $V_{CE} = 10\text{ V}$; $I_C = 10\text{ mA}$; $Z_o = 50\ \Omega$

0,2	0,485	- 84	13,703	116	0,035	58	0,670	-25
0,4	0,313	-125	7,722	94	0,052	60	0,555	-24
0,6	0,264	-150	5,302	84	0,070	63	0,495	-24
0,8	0,239	-167	3,997	74	0,088	62	0,491	-26
1	0,224	176	3,278	67	0,108	61	0,472	-28
1,2	0,229	163	2,778	62	0,126	63	0,475	-31
1,4	0,233	148	2,426	54	0,145	60	0,452	-33
1,6	0,258	138	2,216	48	0,170	58	0,462	-39
1,8	0,266	130	1,959	42	0,186	57	0,455	-43
2	0,294	124	1,745	36	0,209	53	0,459	-49

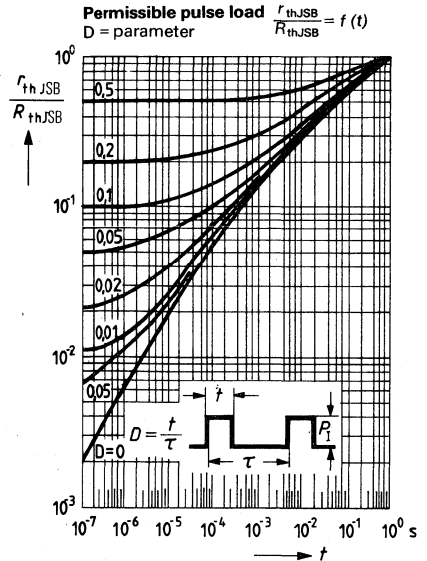
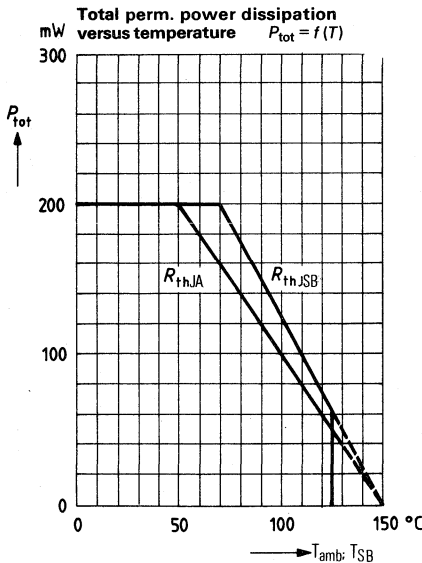

Noise figure $NF = f(R_g)$
 $V_{CE} = 6\text{ V}; f = 10\text{ MHz}$

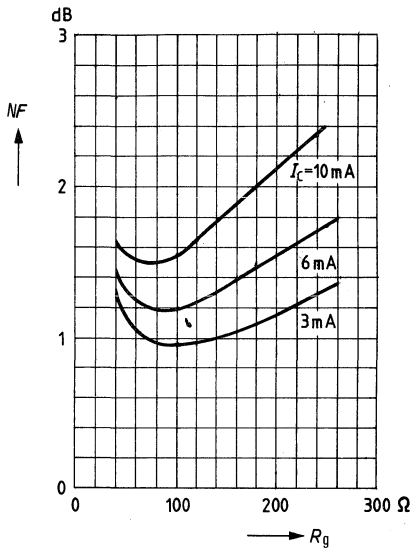

Noise figure $NF_{min} = f(I_C)$
 $V_{CE} = 6\text{ V}; R_{g,opt}; f = 10\text{ MHz}$

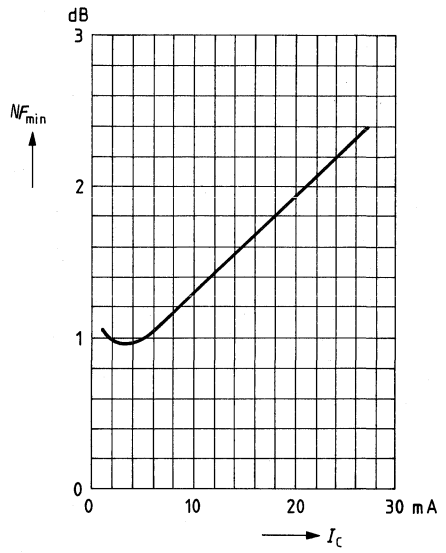

Transition frequency $f_T = f(I_C)$
 $V_{CE} = 6\text{ V}; f = 200\text{ MHz}$

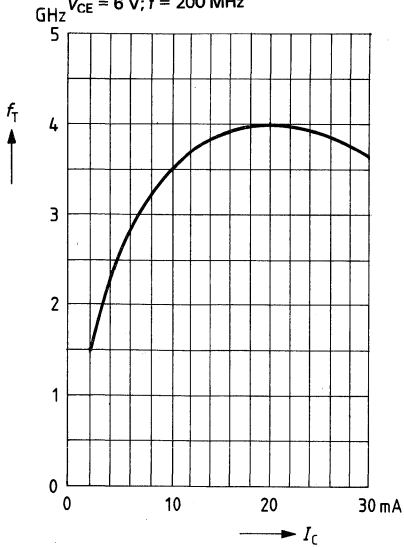

NPN Silicon Microwave Transistor for Application up to 4 GHz

BFQ 57

BFQ 57 is a bipolar silicon NPN microwave transistor in hermetically sealed metal ceramic 100 mil package similar to TO 120. State-of-the-art manufacturing methods such as ion implantation technique, titanium-platinum-gold metallization as well as a glass-passivated chip surface ensure very high reliability. The transistor is particularly suitable for low noise amplifiers and oscillators up to 4 GHz. It is marked on its package with the short designation "57".

Type	Mark	Ordering code
BFQ 57	57	Q62702-F652

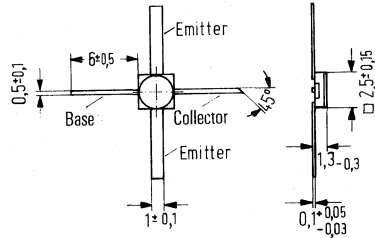

Approx. weight 0.05 g

Dimensions in mm

Maximum ratings

Collector-emitter voltage
 Collector-emitter voltage ($R_{BE} = 0$)
 Collector-base voltage
 Emitter-base voltage
 Collector current
 Storage temperature range
 Junction temperature
 Total power dissipation
 ($T_{amb} < 87^\circ\text{C}$)

V_{CEO}	16	V
V_{CES}	30	V
V_{CBO}	25	V
V_{EBO}	1	V
I_C	35	mA
T_{stg}	-65 to +175	$^\circ\text{C}$
T_j	200	$^\circ\text{C}$
P_{tot}	450	mW

Thermal resistance

Junction to ambient air
 (when mounted on AL_2O_3 ceramics or
 glass-fiber reinforced Teflon 40x25x1.5 mm)

R_{thJA}	≤ 250	K/W
------------	------------	-----

Static characteristics ($T_{\text{amb}} = 25^{\circ}\text{C}$)

Collector-emitter breakdown voltage ($I_C = 100 \mu\text{A}$)	$V_{(\text{BR})\text{CES}}$	30	V
Collector cutoff current ($V_{\text{CBO}} = 15 \text{ V}$)	I_{CBO}	100	nA
Collector cutoff current ($V_{\text{CEO}} = 15 \text{ V}$)	I_{CEO}	500	nA
DC current gain ($V_{\text{CE}} = 15 \text{ V}; I_C = 15 \text{ mA}$)	h_{FE}	120	–

Dynamic characteristics ($T_{\text{amb}} = 25^{\circ}\text{C}$)

Transition frequency ($V_{\text{CE}} = 15 \text{ V}; I_C = 25 \text{ mA}$)	f_T	6.5	GHz
Power gain ($V_{\text{CE}} = 10 \text{ V}; I_C = 25 \text{ mA}; f = 4 \text{ GHz}$)	G_{popt}	10.5	dB
Output power ($G_{\text{popt}} - 1 \text{ dB}$) ($V_{\text{CE}} = 15 \text{ V}; I_C = 25 \text{ mA}; f = 4 \text{ GHz}$)	$P_{1\text{dB}}$	18.5	dBm
Reverse transfer capacitance ($V_{\text{CE}} = 10 \text{ V}; I_C = 1 \text{ mA}; f = 1 \text{ MHz}$)	C_{12e}	0.33	pF

S parameterOperating point: $V_{CE} = 10 \text{ V}$, $I_C = 3 \text{ mA}$, $Z_o = 50 \Omega$

f (GHz)	S_{11}	φ	S_{21}	φ	S_{12}	φ	S_{22}	φ
0,1	0,830	- 20	8,71	164	0,016	74	0,994	- 8
0,2	0,793	- 42	8,24	149	0,031	66	0,931	- 15
0,3	0,758	- 60	7,57	137	0,041	57	0,877	- 21
0,4	0,720	- 78	6,87	127	0,049	49	0,821	- 23
0,5	0,675	- 92	6,15	118	0,055	43	0,768	- 28
0,6	0,641	-106	5,71	109	0,060	37	0,727	- 32
0,7	0,609	-117	5,24	103	0,065	34	0,723	- 34
0,8	0,589	-130	4,77	96	0,066	32	0,684	- 35
0,9	0,574	-140	4,37	91	0,068	30	0,654	- 37
1,0	0,559	-150	3,98	86	0,068	28	0,641	- 38
1,1	0,570	-158	3,65	81	0,069	27	0,609	- 39
1,2	0,560	-164	3,38	76	0,068	27	0,598	- 43
1,3	0,552	-173	3,13	72	0,069	26	0,599	- 43
1,4	0,553	-177	2,93	67	0,070	24	0,582	- 45
1,5	0,534	174	2,75	63	0,067	25	0,575	- 45
1,6	0,553	169	2,61	60	0,069	25	0,575	- 49
1,7	0,555	163	2,44	57	0,071	26	0,594	- 49
1,8	0,567	160	2,32	53	0,073	27	0,575	- 49
1,9	0,548	155	2,20	49	0,072	28	0,559	- 52
2,0	0,560	149	2,10	46	0,074	28	0,565	- 55
2,5	0,597	162	1,80	36	0,079	27	0,531	- 77
3,0	0,594	150	1,57	23	0,091	31	0,541	- 90
3,5	0,616	137	1,35	9	0,107	32	0,528	-110
4,0	0,611	127	1,17	-3	0,127	30	0,558	-123
4,5	0,628	112	1,05	-16	0,149	26	0,557	-141
5,0	0,659	104	0,91	-28	0,170	22	0,587	-158
5,5	0,672	93	0,80	-40	0,188	16	0,620	-175
6,0	0,694	87	0,67	-52	0,200	6	0,654	166

S parameterOperating point: $V_{CE} = 10 \text{ V}$, $I_C = 5 \text{ mA}$, $Z_o = 50 \Omega$

f (GHz)	S_{11}	φ	S_{21}	φ	S_{12}	φ	S_{22}	φ
0,1	0,766	- 26	12,63	160	0,015	74	0,979	- 10
0,2	0,721	- 52	11,66	144	0,028	61	0,892	- 19
0,3	0,672	- 73	10,32	131	0,036	54	0,816	- 25
0,4	0,630	- 92	9,04	120	0,042	46	0,747	- 29
0,5	0,594	-106	7,91	111	0,046	41	0,689	- 31
0,6	0,564	-121	7,11	103	0,051	38	0,650	- 34
0,7	0,539	-132	6,42	97	0,053	37	0,643	- 35
0,8	0,529	-144	5,79	91	0,056	36	0,603	- 35
0,9	0,516	-153	5,23	86	0,058	35	0,576	- 38
1,0	0,519	-163	4,73	82	0,059	34	0,565	- 39
1,1	0,525	-169	4,31	77	0,061	34	0,538	- 39
1,2	0,515	-175	3,97	73	0,061	33	0,530	- 44
1,3	0,515	176	3,66	69	0,062	32	0,531	- 43
1,4	0,514	174	3,42	65	0,064	32	0,517	- 45
1,5	0,498	165	3,21	61	0,063	35	0,506	- 45
1,6	0,517	160	3,03	59	0,066	35	0,511	- 49
1,7	0,520	156	2,84	56	0,069	36	0,531	- 49
1,8	0,533	153	2,69	52	0,071	35	0,517	- 49
1,9	0,519	148	2,55	48	0,073	37	0,498	- 51
2,0	0,531	143	2,42	45	0,076	36	0,501	- 55
2,5	0,569	156	2,13	36	0,086	37	0,458	- 76
3,0	0,560	146	1,84	24	0,102	38	0,469	- 89
3,5	0,592	134	1,60	10	0,119	36	0,455	-108
4,0	0,579	123	1,39	-2	0,139	32	0,483	-122
4,5	0,609	110	1,25	-14	0,162	27	0,484	-139
5,0	0,628	101	1,08	-27	0,181	22	0,526	-157
5,5	0,656	91	0,96	-39	0,202	16	0,563	-172
6,0	0,663	85	0,83	-51	0,211	7	0,603	168

S parameterOperating point: $V_{CE} = 10 \text{ V}$, $I_C = 10 \text{ mA}$, $Z_o = 50 \Omega$

f (GHz)	S_{11}	φ	S_{21}	φ	S_{12}	φ	S_{22}	φ
0,1	0,630	- 40	21,76	153	0,013	69	0,933	- 15
0,2	0,576	- 75	18,26	133	0,023	55	0,795	- 25
0,3	0,529	-100	14,93	120	0,028	52	0,690	- 30
0,4	0,504	-119	12,19	110	0,032	47	0,617	- 33
0,5	0,485	-133	10,27	101	0,035	44	0,564	- 34
0,6	0,474	-146	8,92	95	0,037	45	0,532	- 35
0,7	0,461	-156	7,89	89	0,042	45	0,526	- 36
0,8	0,469	-166	6,96	84	0,045	46	0,495	- 35
0,9	0,463	-173	6,24	80	0,048	47	0,475	- 37
1,0	0,474	178	5,61	77	0,049	48	0,467	- 38
1,1	0,480	173	5,07	73	0,052	46	0,446	- 38
1,2	0,473	169	4,68	69	0,055	47	0,441	- 43
1,3	0,481	162	4,30	65	0,058	46	0,446	- 42
1,4	0,475	160	4,00	62	0,061	46	0,433	- 44
1,5	0,465	152	3,75	59	0,063	49	0,428	- 44
1,6	0,487	149	3,53	57	0,067	49	0,434	- 48
1,7	0,490	145	3,29	54	0,070	48	0,453	- 48
1,8	0,500	143	3,12	50	0,073	47	0,443	- 48
1,9	0,489	139	2,96	47	0,077	47	0,426	- 50
2,0	0,503	134	2,80	44	0,082	47	0,425	- 54
2,5	0,542	150	2,45	36	0,091	45	0,383	- 75
3,0	0,529	140	2,11	25	0,112	43	0,391	- 88
3,5	0,574	130	1,84	12	0,131	39	0,376	-107
4,0	0,554	119	1,61	0	0,151	33	0,409	-121
4,5	0,598	107	1,46	-11	0,173	27	0,410	-139
5,0	0,608	98	1,28	-23	0,191	21	0,454	-157
5,5	0,637	90	1,14	-35	0,211	14	0,492	-172
6,0	0,643	82	0,97	-48	0,218	6	0,540	168

SparameterOperating point: $V_{CE} = 10 \text{ V}$, $I_C = 15 \text{ mA}$, $Z_o = 50 \Omega$

f (GHz)	S ₁₁	φ	S ₂₁	φ	S ₁₂	φ	S ₂₂	φ
0,1	0,544	- 52	27,77	148	0,012	67	0,896	- 17
0,2	0,502	- 92	22,07	126	0,020	55	0,729	- 28
0,3	0,478	-118	16,87	114	0,025	52	0,623	- 32
0,4	0,461	-135	13,38	104	0,028	50	0,553	- 33
0,5	0,452	-148	11,10	97	0,030	49	0,506	- 33
0,6	0,450	-159	9,53	91	0,034	51	0,483	- 34
0,7	0,442	-167	8,35	86	0,038	50	0,482	- 35
0,8	0,455	-176	7,35	82	0,041	52	0,456	- 34
0,9	0,454	177	6,57	78	0,044	53	0,441	- 36
1,0	0,465	170	5,88	74	0,048	53	0,438	- 37
1,1	0,473	166	5,31	71	0,050	53	0,415	- 37
1,2	0,468	162	4,90	67	0,054	54	0,414	- 42
1,3	0,478	156	4,50	64	0,057	52	0,421	- 41
1,4	0,469	155	4,19	60	0,061	52	0,407	- 43
1,5	0,461	147	3,91	58	0,062	54	0,401	- 43
1,6	0,482	145	3,68	56	0,067	54	0,410	- 47
1,7	0,487	141	3,44	53	0,071	53	0,429	- 47
1,8	0,499	138	3,24	49	0,075	52	0,419	- 47
1,9	0,486	135	3,08	47	0,078	52	0,402	- 49
2,0	0,518	156	3,10	49	0,077	52	0,372	- 59
2,5	0,538	148	2,54	36	0,095	48	0,359	- 74
3,0	0,536	139	2,21	25	0,115	45	0,368	- 87
3,5	0,570	128	1,91	12	0,135	40	0,354	-107
4,0	0,565	119	1,69	0	0,154	34	0,391	-121
4,5	0,596	106	1,53	-11	0,177	28	0,385	-140
5,0	0,622	99	1,35	-22	0,196	22	0,434	-157
5,5	0,636	89	1,20	-33	0,214	15	0,472	-172
6,0	0,659	84	1,03	-46	0,222	6	0,515	168

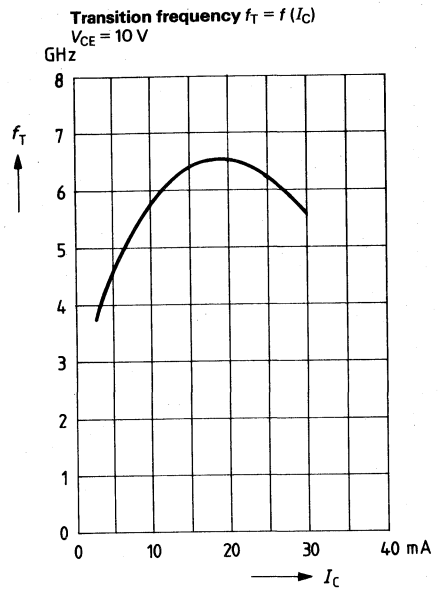
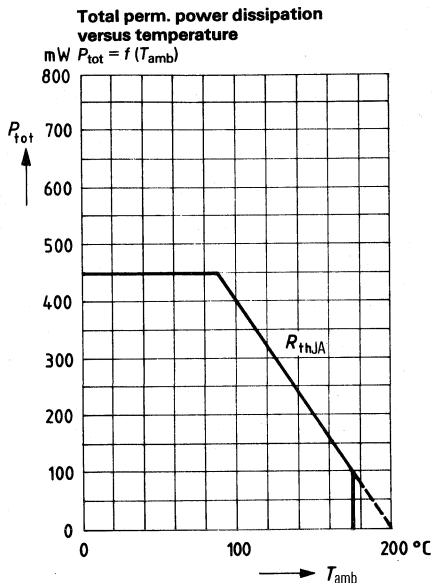

Low-Noise NPN Silicon Microwave Transistor up to 4 GHz BFQ 58

BFQ 58 is a bipolar silicon NPN microwave transistor in hermetically sealed metal ceramic 100 mil package similar to TO 120. State-of-the-art manufacturing processes such as ion implantation technique, titanium-platinum-gold metallization as well as a glass passivated chip surface ensure very high reliability. The transistor is particularly intended for use in low-noise amplifiers and oscillators up to 4 GHz. It is marked on its package with the short designation "58".

Type	Mark	Ordering code
BFQ 58	58	Q62702-F653

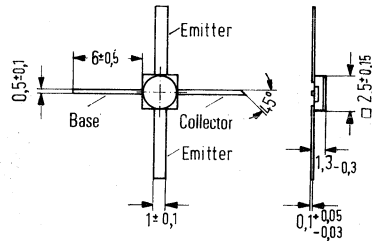

Approx. weight 0.05 g

Dimensions in mm

Maximum ratings

Collector-emitter voltage	V_{CE0}	16	V
Collector-emitter voltage ($R_{BE} = 0$)	V_{CES}	30	V
Collector-base voltage	V_{CBO}	25	V
Emitter base voltage	V_{EBO}	1	V
Collector current	I_C	30	mA
Storage temperature range	T_{stg}	-65 to +175	$^\circ\text{C}$
Junction temperature	T_j	200	$^\circ\text{C}$
Total power dissipation ($T_{amb} \leq 87^\circ\text{C}$)	P_{tot}	450	mW

Thermal resistance

Junction to ambient air (when mounted on Al_2O_3 ceramics or glass-fiber reinforced Teflon 40x25x1.5 mm.)	R_{thJA}	≤ 250	K/W
---	------------	------------	-----

Static characteristics ($T_{\text{amb}} = 25^{\circ}\text{C}$)

Collector-emitter breakdown voltage ($I_C = 100 \mu\text{A}$)	$V_{(\text{BR})\text{CES}}$	30	V
Collector cutoff current ($V_{\text{CBO}} = 15 \text{ V}$)	I_{CBO}	100	nA
Collector cutoff current ($V_{\text{CEO}} = 15 \text{ V}$)	I_{CEO}	500	nA
DC current gain ($V_{\text{CE}} = 15 \text{ V}; I_C = 15 \text{ mA}$)	h_{FE}	120	–

Dynamic characteristics ($T_{\text{amb}} = 25^{\circ}\text{C}$)

Transition frequency ($V_{\text{CE}} = 15 \text{ V}; I_C = 25 \text{ mA}$)	f_T	6.5	GHz
Noise figure ($V_{\text{CE}} = 15 \text{ V}; I_C = 15 \text{ mA}; f = 4 \text{ GHz}$)	NF_{min}	3.8	dB
($V_{\text{CE}} = 15 \text{ V}; I_C = 15 \text{ mA}; f = 1.5 \text{ GHz}$)	NF_{min}	2.2	dB
Power gain at noise matching ($V_{\text{CE}} = 15 \text{ V}; I_C = 15 \text{ mA}; f = 4 \text{ GHz}$)	G_{GP}	9	dB
($V_{\text{CE}} = 15 \text{ V}; I_C = 15 \text{ mA}; f = 1.5 \text{ GHz}$)	G_{GP}	15	dB
Output power ($G_{\text{popt}} - 1 \text{ dB}$) ($V_{\text{CE}} = 15 \text{ V}; I_C = 15 \text{ mA}; f = 4 \text{ GHz}$)	$P_1 \text{ dB}$	14	dBm
Noise figure (measured) ¹⁾ ($V_{\text{CE}} = 15 \text{ V}; I_C = 15 \text{ mA}; f = 4 \text{ GHz}$)	NF_{min}	4.2	dB
Reverse transfer capacitance ($V_{\text{CE}} = 10 \text{ V}; I_C = 1 \text{ mA}; f = 1 \text{ MHz}$)	C_{12e}	0.33	pF

$$1) NF_{\text{min}} = 10 \log \left(1 + \frac{NF_{\text{min}} - 1}{1 - \frac{1}{G_{\text{GP}}}} \right)$$

S parameter:Operating point: $V_{CE} = 15 \text{ V}$, $I_C = 15 \text{ mA}$, $Z_o = 50 \Omega$

f (GHz)	S_{11}	φ	S_{21}	φ	S_{12}	φ	S_{22}	φ	G_{\max} (dB)
0,1	0,615	- 42	25,67	153	0,013	67	0,913	- 17	38,0
0,2	0,591	- 81	21,93	134	0,022	52	0,743	- 29	32,2
0,3	0,568	-106	18,07	121	0,028	48	0,673	- 36	29,5
0,4	0,583	-123	14,90	113	0,030	45	0,588	- 37	27,1
0,5	0,582	-133	12,51	104	0,033	42	0,538	- 40	25,2
0,6	0,558	-142	10,81	98	0,036	40	0,496	- 39	23,5
0,7	0,538	-152	9,41	92	0,037	41	0,464	- 40	22,0
0,8	0,550	-160	8,36	88	0,039	42	0,424	- 40	20,9
0,9	0,546	-166	7,47	84	0,041	43	0,403	- 44	19,8
1	0,550	-170	6,75	81	0,044	43	0,407	- 44	19,0
1,1	0,552	-175	6,10	78	0,046	43	0,379	- 46	18,0
1,2	0,563	-177	5,60	74	0,048	43	0,390	- 48	17,4
1,3	0,545	178	5,18	71	0,050	44	0,367	- 48	16,4
1,4	0,562	174	4,87	68	0,054	42	0,389	- 53	16,1
1,5	0,562	172	4,55	66	0,055	45	0,370	- 47	15,4
1,6	0,548	168	4,28	64	0,058	46	0,377	- 56	14,9
1,7	0,557	164	3,97	61	0,059	46	0,387	- 50	14,3
1,8	0,564	165	3,73	58	0,062	46	0,359	- 57	13,7
1,9	0,532	160	3,56	57	0,065	47	0,403	- 55	13,2
2	0,534	158	3,40	56	0,069	45	0,366	- 58	12,7
2,5	0,558	151	2,79	42	0,083	43	0,371	- 72	11,2
3	0,532	140	2,33	31	0,097	41	0,388	- 79	9,5
3,5	0,556	132	2,02	22	0,111	39	0,380	- 92	8,4
4	0,521	121	1,78	9	0,128	33	0,423	-100	7,3
4,5	0,546	110	1,63	0	0,146	28	0,418	-109	6,6
5	0,538	97	1,51	-11	0,164	24	0,451	-119	6,1
5,5	0,568	86	1,37	-21	0,181	21	0,442	-129	5,4
6	0,590	76	1,23	-33	0,194	10	0,442	-144	4,6

Total perm. power dissipation versus temperature

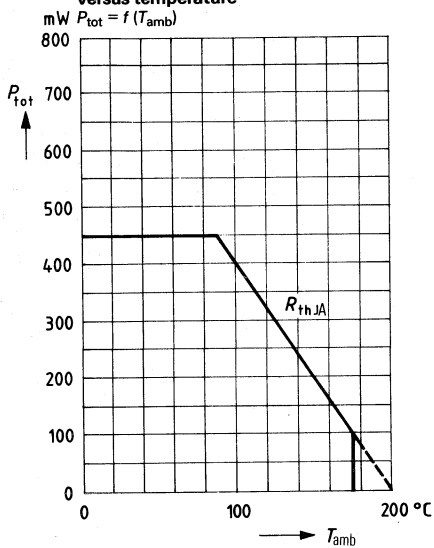

Transition frequency $f_T = f(I_C)$

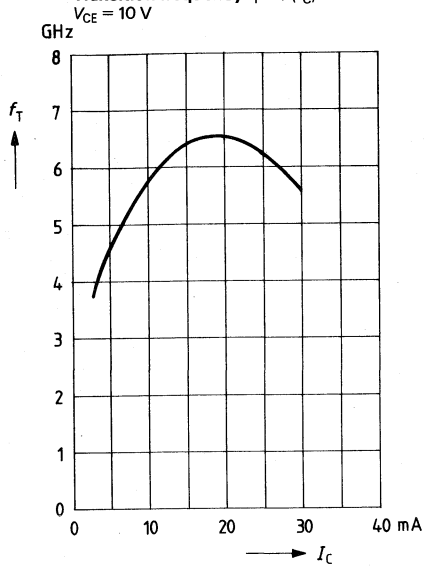

Noise figure $NF = f(I_C)$

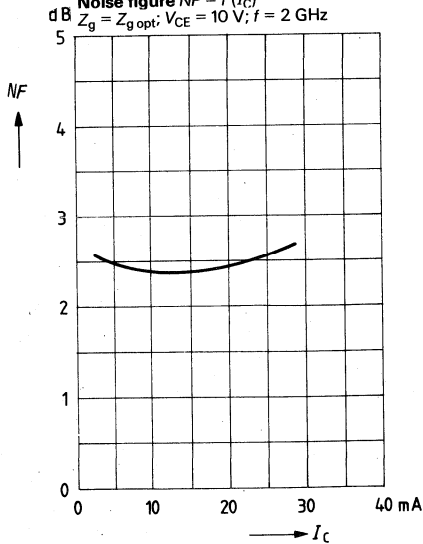

Low Noise NPN Silicon Microwave Transistor up to 2 GHz BFG 59

BFG 59 is a bipolar silicon NPN microwave transistor in hermetically sealed metal ceramic 200 mil package similar to TO 120. State-of-the-art manufacturing processes such as ion implantation technique, titanium-platinum-gold metallization as well as a glass passivated chip surface ensure very high reliability. The transistor is particularly intended for use in low-noise broadband linear amplifiers up to 2 GHz. It is marked on its package with the short designation "59".

Type	Mark	Ordering code
BFG 59	59	Q62702-F654

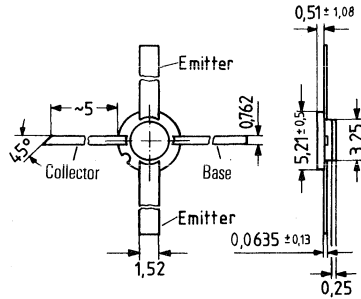

Approx. weight 0.08 g Dimensions in mm

Maximum ratings

Collector-emitter voltage	V_{CEO}	20	V
Collector-emitter voltage ($R_{BE} = 0$)	V_{CES}	27	V
Collector-base voltage	V_{CBO}	27	V
Emitter-base voltage	V_{EBO}	1.5	V
Collector current	I_C	35	mA
Storage temperature range	T_{stg}	-65 to +175	°C
Junction temperature	T_j	200	°C
Total power dissipation ($T_{case} \leq 150^\circ\text{C}$)	P_{tot}	700	mW

Thermal resistance

Junction to case	R_{thJC}	≤ 70	K/W
------------------	------------	-----------	-----

Static characteristics ($T_{amb} = 25^{\circ}\text{C}$)

Collector-emitter breakdown voltage ($I_C = 100 \mu\text{A}$)	$V_{(BR)CES}$	27	V
Collector cutoff current ($V_{CBO} = 15 \text{ V}$)	I_{CBO}	100	nA
DC current gain ($V_{CE} = 15 \text{ V}; I_C = 15 \text{ mA}$)	h_{FE}	100	–

Dynamic characteristics ($T_{amb} = 25^{\circ}\text{C}$)

Transition frequency ($V_{CE} = 10 \text{ V}; I_C = 25 \text{ mA}$)	f_T	4	GHz
Noise figure ($V_{CE} = 10 \text{ V}; I_C = 3 \text{ mA}; f = 10 \text{ MHz}$)	NF	0.9	dB
($V_{CE} = 10 \text{ V}; I_C = 8 \text{ mA}; f = 2 \text{ GHz}$)	NF	3.4	dB
Reverse transfer capacitance ($V_{CE} = 10 \text{ V}; I_C = 1 \text{ mA}; f = 1 \text{ MHz}$)	C_{12e}	0.6	pF
Power gain ($V_{CE} = 10 \text{ V}; I_C = 15 \text{ mA}; f = 2 \text{ GHz}$)	$G_{pe \text{ opt}}$	11	dB

S parameterOperating point: $V_{CE} = 6 \text{ V}$, $I_C = 3 \text{ mA}$, $Z_o = 50 \Omega$

f (GHz)	S_{11}	φ	S_{21}	φ	S_{12}	φ	S_{22}	φ	G_{\max} (dB)
0,1	0,871	- 31	6,86	156	0,031	70	0,993	-12	41,7
0,2	0,848	- 58	6,37	140	0,054	54	0,872	-21	27,8
0,3	0,791	- 81	5,68	126	0,068	44	0,774	-28	23,3
0,4	0,769	- 99	5,00	116	0,075	36	0,694	-35	20,7
0,5	0,732	-114	4,36	108	0,080	31	0,681	-36	18,8
0,6	0,722	-126	3,86	100	0,084	27	0,616	-38	17,0
0,7	0,693	-136	3,44	93	0,087	24	0,618	-41	15,7
0,8	0,691	-144	3,11	87	0,087	21	0,587	-40	14,5
0,9	0,662	-154	2,82	81	0,087	19	0,537	-46	13,0
1	0,691	-158	2,59	76	0,089	18	0,594	-48	13,0
1,1	0,662	-166	2,40	72	0,089	17	0,534	-46	11,6
1,2	0,695	-169	2,22	68	0,089	17	0,534	-55	11,3
1,3	0,657	-174	2,05	64	0,088	17	0,535	-54	10,2
1,4	0,719	-176	1,90	60	0,088	16	0,543	-59	10,3
1,5	0,651	-179	1,78	56	0,086	17	0,532	-56	8,9
1,6	0,673	176	1,70	53	0,086	19	0,544	-63	8,8
1,7	0,646	172	1,58	50	0,086	19	0,551	-61	7,9
1,8	0,676	168	1,51	46	0,086	20	0,549	-66	7,8
1,9	0,658	166	1,45	43	0,087	21	0,548	-64	7,3
2	0,662	162	1,40	40	0,089	23	0,543	-71	7,0

Operating point: $V_{CE} = 6 \text{ V}$, $I_C = 10 \text{ mA}$, $Z_o = 50 \Omega$

f (GHz)	S_{11}	φ	S_{21}	φ	S_{12}	φ	S_{22}	φ	G_{\max} (dB)
0,1	0,718	- 58	18,56	144	0,024	56	0,853	-26	34,2
0,2	0,673	-103	15,08	121	0,035	43	0,616	-38	28,3
0,3	0,650	-128	11,48	108	0,040	39	0,487	-41	24,8
0,4	0,636	-142	9,13	99	0,043	38	0,420	-47	22,3
0,5	0,625	-154	7,47	93	0,045	37	0,413	-45	20,4
0,6	0,635	-160	6,27	88	0,048	38	0,359	-45	18,8
0,7	0,620	-167	5,47	83	0,052	40	0,369	-47	17,5
0,8	0,613	-171	4,83	78	0,055	41	0,341	-42	16,3
0,9	0,611	-179	4,28	74	0,058	41	0,302	-52	15,1
1	0,632	179	3,90	70	0,061	42	0,365	-52	14,7
1,1	0,607	173	3,57	67	0,064	43	0,314	-47	13,5
1,2	0,636	172	3,29	64	0,069	44	0,323	-59	13,1
1,3	0,606	167	3,03	61	0,072	44	0,326	-56	12,1
1,4	0,664	167	2,84	58	0,075	45	0,339	-62	12,1
1,5	0,597	164	2,63	55	0,078	46	0,331	-56	10,8
1,6	0,621	161	2,49	52	0,082	47	0,339	-66	10,6
1,7	0,594	158	2,33	50	0,086	47	0,349	-61	9,8
1,8	0,628	156	2,21	47	0,091	47	0,353	-68	9,7
1,9	0,607	154	2,12	44	0,095	47	0,352	-64	9,1
2	0,610	150	2,04	41	0,101	47	0,352	-73	8,8

S parameterOperating point: $V_{CE} = 6 \text{ V}$, $I_C = 20 \text{ mA}$, $Z_o = 50 \Omega$

f (GHz)	S_{11}	φ	S_{21}	φ	S_{12}	φ	S_{22}	φ	G_{\max} (dB)
0,1	0,612	- 89	28,27	133	0,018	51	0,724	-34	34,3
0,2	0,617	-133	18,89	110	0,024	42	0,475	-43	28,7
0,3	0,619	-151	13,37	100	0,028	45	0,367	-43	25,2
0,4	0,616	-160	10,31	93	0,032	46	0,319	-49	22,8
0,5	0,614	-169	8,31	88	0,035	49	0,324	-44	20,9
0,6	0,625	-172	6,90	84	0,040	50	0,278	-44	19,3
0,7	0,611	-177	5,99	79	0,044	52	0,296	-46	18,0
0,8	0,604	179	5,26	75	0,048	53	0,272	-40	16,7
0,9	0,610	172	4,65	72	0,052	53	0,236	-51	15,6
1	0,626	172	4,24	68	0,057	54	0,301	-51	15,1
1,1	0,606	166	3,88	65	0,062	54	0,257	-45	14,1
1,2	0,633	166	3,57	62	0,066	54	0,265	-59	13,6
1,3	0,603	161	3,27	59	0,070	55	0,268	-54	12,6
1,4	0,658	162	3,04	57	0,074	54	0,282	-61	12,5
1,5	0,594	159	2,84	53	0,079	55	0,279	-54	11,3
1,6	0,616	157	2,69	51	0,084	55	0,285	-65	11,0
1,7	0,591	154	2,53	48	0,089	55	0,299	-59	10,3
1,8	0,625	152	2,40	46	0,094	54	0,301	-67	10,2
1,9	0,602	150	2,29	43	0,099	53	0,302	-62	9,6
2	0,606	147	2,20	41	0,105	53	0,301	-71	9,3

Total perm. power dissipation versus temperature

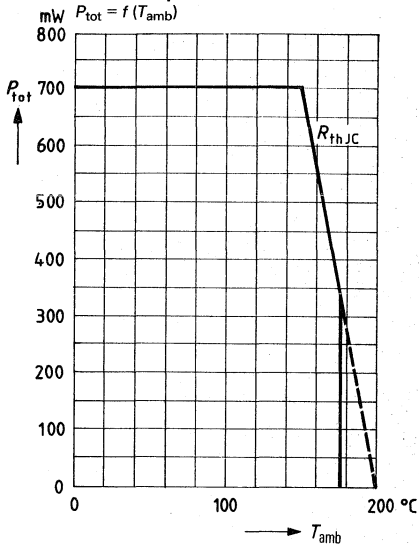

Transition frequency $f_T = f(I_C)$

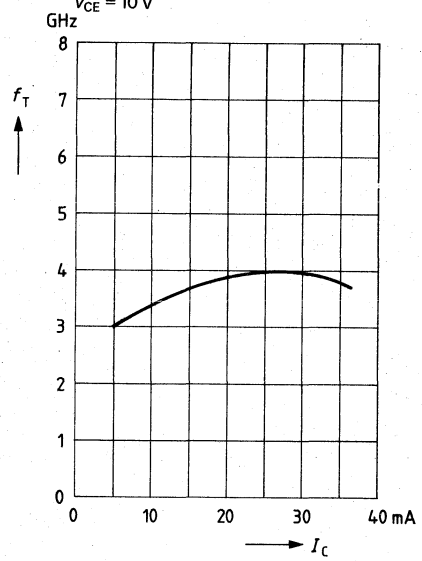

Noise figure $NF = f(I_C)$

$\text{dB } Z_g = Z_{g \text{ opt}}; V_{CE} = 10\text{ V}; f = 2\text{ GHz}$

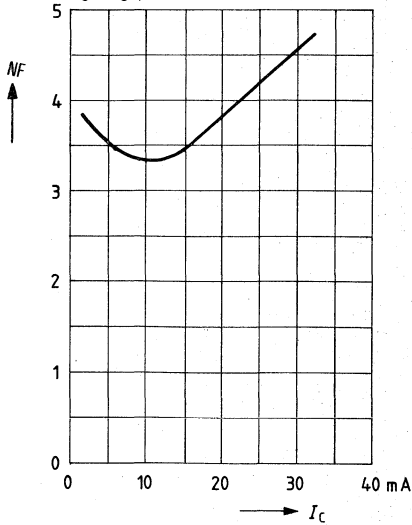

Low Noise NPN Silicon Microwave Transistor up to 2 GHz

BFQ 60

BFQ 60 is a bipolar silicon NPN microwave transistor in hermetically sealed metal ceramic 100 mil package similar to TO 120. State-of-the-art manufacturing processes such as ion implantation technique, titanium-platinum-gold metallization as well as a glass passivated chip surface ensure very high reliability. The transistor is particularly intended for use in low-noise broadband linear amplifiers. It is marked on its package with the short designation "60".

Type	Mark	Ordering code
BFQ 60	60	Q62702-F655

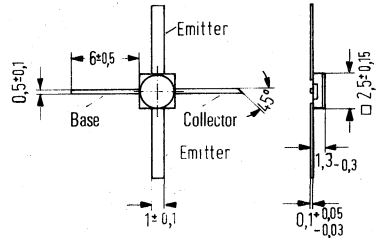

Approx. weight 0.05 g Dimensions in mm

Maximum ratings

Collector-emitter voltage	V_{CE0}	20	V
Collector-emitter voltage ($R_{BE} = 0$)	V_{CES}	27	V
Collector-base voltage	V_{CBO}	27	V
Emitter-base voltage	V_{EBO}	1.5	V
Collector current	I_C	35	mA
Storage temperature range	T_{stg}	-65 to +175	°C
Junction temperature	T_j	200	°C
Total power dissipation ($T_{amb} < 25^\circ\text{C}$)	P_{tot}	700	mW

Thermal resistance

Junction to ambient air	R_{thJA}	≤ 250	K/W
-------------------------	------------	------------	-----

(when mounted on ceramic – or glass-fiber substrate 40 x 25 x 1.5 mm)

Static characteristics ($T_{\text{amb}} = 25 \text{ C}$)

Collector-emitter breakdown voltage ($I_C = 100 \mu\text{A}$)	$V_{(\text{BR})\text{CES}}$	27	V
Collector cutoff current ($V_{\text{CBO}} = 15 \text{ V}$)	I_{CBO}	100	nA
DC current gain ($V_{\text{CE}} = 15 \text{ V}; I_C = 15 \text{ mA}$)	h_{FE}	100	-

Dynamic characteristics ($T_{\text{amb}} = 25 \text{ C}$)

Transition frequency ($V_{\text{CE}} = 10 \text{ V}; I_C = 25 \text{ mA}$)	f	4	GHz
Noise figure ($V_{\text{CE}} = 10 \text{ V}; I_C = 3 \text{ mA}; f = 10 \text{ MHz}$)	NF	0.9	dB
($V_{\text{CE}} = 10 \text{ V}; I_C = 8 \text{ mA}; f = 2 \text{ GHz}$)	NF	3.4	dB
Reverse transfer capacitance ($V_{\text{CE}} = 10 \text{ V}; I_C = 1 \text{ mA}; f = 1 \text{ MHz}$)	C_{12e}	0.6	pF
Power gain ($V_{\text{CE}} = 10 \text{ V}; I_C = 15 \text{ mA}; f = 2 \text{ GHz}$)	$G_{\text{pe opt}}$	11	dB

S parameterOperating point: $V_{CE} = 6 \text{ V}$, $I_C = 3 \text{ mA}$, $Z_o = 50 \Omega$

f (GHz)	S_{11}	φ	S_{21}	φ	S_{12}	φ	S_{22}	φ	G_{\max} (dB)
0,1	0,836	- 32	6,77	156	0,030	69	0,995	-11	41,7
0,2	0,819	- 60	6,25	140	0,052	55	0,872	-19	26,9
0,3	0,759	- 84	5,54	125	0,067	44	0,747	-27	22,1
0,4	0,739	-103	4,85	115	0,074	36	0,686	-36	19,9
0,5	0,708	-119	4,24	106	0,079	31	0,708	-34	18,6
0,6	0,702	-132	3,77	99	0,083	27	0,605	-34	16,4
0,7	0,674	-143	3,37	91	0,086	24	0,611	-40	15,2
0,8	0,671	-153	3,04	84	0,086	20	0,595	-37	14,2
0,9	0,659	-163	2,76	78	0,086	18	0,517	-43	12,7
1	0,673	-167	2,52	73	0,088	17	0,587	-46	12,5
1,1	0,654	-177	2,34	68	0,088	16	0,526	-42	11,2
1,2	0,698	-179	2,17	64	0,088	16	0,507	-53	10,9
1,3	0,652	173	2,00	59	0,086	15	0,516	-52	9,8
1,4	0,715	170	1,85	55	0,087	15	0,516	-57	9,8
1,5	0,661	167	1,74	51	0,084	15	0,502	-54	8,6
1,6	0,682	163	1,65	48	0,085	17	0,509	-62	8,4
1,7	0,656	158	1,55	44	0,086	18	0,511	-60	7,6
1,8	0,690	154	1,47	40	0,087	19	0,509	-67	7,5
1,9	0,686	151	1,41	37	0,088	20	0,500	-65	7,0
2	0,678	147	1,35	33	0,089	22	0,492	-73	6,5

Operating point: $V_{CE} = 6 \text{ V}$, $I_C = 10 \text{ mA}$, $Z_o = 50 \Omega$

0,1	0,662	- 60	18,44	143	0,024	56	0,858	-24	33,6
0,2	0,643	-106	14,78	121	0,034	44	0,619	-36	27,8
0,3	0,618	-131	11,23	107	0,039	38	0,467	-41	24,2
0,4	0,615	-147	8,90	98	0,042	39	0,422	-50	21,9
0,5	0,612	-159	7,32	92	0,045	38	0,440	-42	20,3
0,6	0,620	-165	6,16	87	0,048	39	0,346	-40	18,5
0,7	0,607	-173	5,36	81	0,052	40	0,361	-47	17,2
0,8	0,604	-179	4,73	76	0,055	41	0,343	-38	16,0
0,9	0,616	173	4,20	71	0,058	41	0,276	-48	14,9
1	0,621	172	3,81	67	0,062	41	0,353	-51	14,3
1,1	0,611	163	3,49	63	0,066	42	0,298	-43	13,3
1,2	0,646	163	3,21	60	0,070	43	0,286	-58	12,9
1,3	0,610	157	2,95	57	0,073	42	0,296	-54	11,8
1,4	0,671	157	2,74	53	0,076	42	0,297	-60	11,8
1,5	0,616	153	2,55	50	0,081	43	0,288	-54	10,6
1,6	0,636	151	2,42	47	0,085	44	0,291	-66	10,3
1,7	0,616	146	2,27	44	0,089	44	0,296	-60	9,6
1,8	0,655	144	2,15	41	0,094	44	0,293	-69	9,5
1,9	0,645	141	2,05	38	0,099	43	0,285	-64	9,0
2	0,642	138	1,96	35	0,104	43	0,282	-76	8,5

S parameterOperating point: $V_{CE} = 6 \text{ V}$, $I_C = 20 \text{ mA}$, $Z_o = 50 \Omega$

f (GHz)	S_{11}	φ	S_{21}	φ	S_{12}	φ	S_{22}	φ	G_{\max} (dB)
0,1	0,568	- 91	27,40	133	0,018	53	0,735	-32	33,8
0,2	0,597	-134	18,41	111	0,024	44	0,481	-40	28,4
0,3	0,595	-153	13,11	99	0,028	45	0,349	-43	24,8
0,4	0,597	-163	10,06	92	0,032	47	0,323	-53	22,4
0,5	0,601	-172	8,14	87	0,036	49	0,349	-42	20,7
0,6	0,610	-176	6,75	82	0,041	51	0,265	-38	18,9
0,7	0,598	177	5,86	77	0,046	52	0,284	-46	17,7
0,8	0,596	172	5,16	73	0,050	52	0,273	-35	16,5
0,9	0,612	166	4,56	69	0,054	52	0,208	-47	15,4
1	0,617	165	4,15	65	0,059	52	0,287	-51	14,8
1,1	0,610	157	3,80	62	0,064	52	0,238	-39	13,9
1,2	0,640	158	3,41	59	0,069	52	0,224	-57	13,4
1,3	0,608	152	3,19	55	0,073	51	0,235	-52	12,3
1,4	0,668	153	2,95	52	0,077	51	0,238	-59	12,2
1,5	0,614	149	2,76	49	0,082	52	0,229	-51	11,1
1,6	0,633	147	2,61	47	0,087	51	0,233	-65	10,8
1,7	0,614	143	2,46	43	0,092	51	0,238	-58	10,1
1,8	0,650	141	2,32	40	0,097	49	0,237	-68	10,0
1,9	0,643	138	2,22	37	0,103	48	0,231	-61	9,5
2	0,647	135	2,12	35	0,109	48	0,225	-76	9,1

Total perm. power dissipation versus temperature

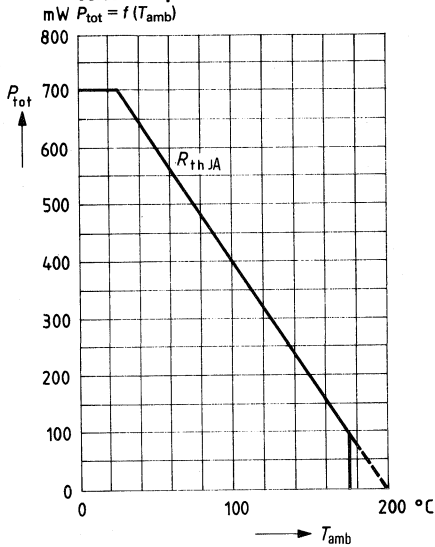

Transition frequency $f_T = f(I_C)$
 $V_{CE} = 10\text{ V}$

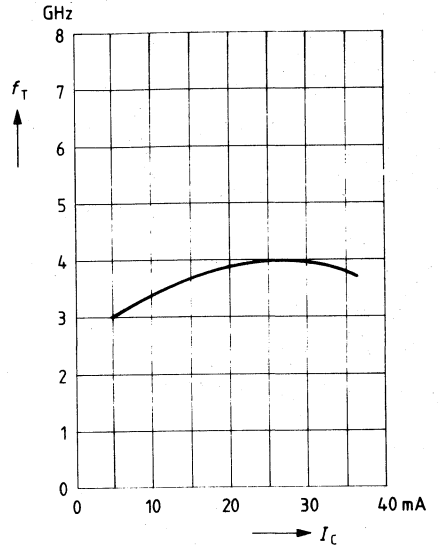

Noise figure $NF = f(I_C)$
dB $Z_g = Z_{g,opt}; V_{CE} = 10\text{ V}; f = 2\text{ GHz}$

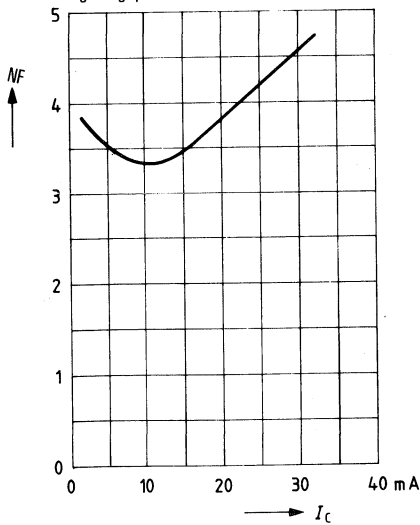

BFR 14 A is an epitaxial NPN silicon planar microwave transistor in hermetically sealed metal ceramic 140 mil package similar to TO 120. Because of its low noise figure, high gain, and low distortion, the transistor is particularly intended for use in low-noise input stages, broadband, IF, and radar amplifiers up to 4 GHz, as well as for oscillator circuits of low performance.

The ceramic package is especially suitable for thin and thick film circuits and permits Space applications. The common emitter terminal is connected to the package. The transistor is marked on its package with the full type designation.

Type	Ordering code
BFR 14 A	Q62702-F416

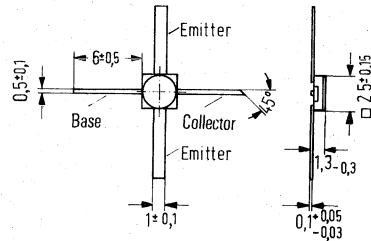

Approx. weight 0.05 g Dimensions in mm

Maximum ratings

Collector-emitter voltage	V_{CE0}	12	V
Collector-base voltage	V_{CB0}	20	V
Collector-emitter voltage ($R_{BE} \leq 50 \Omega$)	V_{CER}	20	V
Emitter base voltage	V_{EBO}	2.5	V
Collector current	I_C	30	mA
Collector current	I_B	4	mA
Junction temperature	T_j	200	°C
Storage temperature range	T_{stg}	-65 to +175	°C
Total power dissipation ($T_{amb} \leq 137^\circ\text{C}$)	P_{tot}	250	mW

Thermal resistance

Junction to ambient air (when mounted on Al_2O_3 ceramics 16x25x0.6 mm or glass-fiber reinforced Teflon 40x25x1.5 mm)	R_{thJA}	≤ 250	K/W
---	------------	------------	-----

Static characteristics ($T_{amb} = 25^{\circ}\text{C}$)

Collector-emitter breakdown voltage

($I_{CEO} = 500 \mu\text{A}$)

$V_{(BR)CEO}$	≥ 12	V
---------------	-----------	---

Collector-emitter breakdown voltage

($I_{CER} = 10 \text{ mA}$; $R_{BE} = 50 \Omega$)

$V_{(BR)CER}$	≥ 20	V
---------------	-----------	---

Emitter-base breakdown voltage

($I_{EBO} = 100 \mu\text{A}$)

$V_{(BR)EBO}$	≥ 2.5	V
---------------	------------	---

Collector cutoff current ($V_{CBO} = 10 \text{ V}$)($V_{CBO} = 10 \text{ V}$; $T = 150^{\circ}\text{C}$)

I_{CBO}	< 50	nA
-----------	--------	----

Collector cutoff current

($V_{CE} = 20 \text{ V}$; $V_{BE} = 0$)

I_{CBO}	< 50	μA
-----------	--------	---------------

DC current gain

($I_C = 5 \text{ mA}$; $V_{CE} = 6 \text{ V}$)

I_{CES}	< 100	μA
-----------	---------	---------------

h_{FE}	> 30	-
----------	--------	---

Dynamic characteristics ($T_{amb} = 25^{\circ}\text{C}$)

Small signal current gain

($I_C = 5 \text{ mA}$; $V_{CE} = 6 \text{ V}$; $f = 1 \text{ kHz}$)

h_{fe}	75 (≥ 40)	-
----------	------------------	---

($I_C = 20 \text{ mA}$; $V_{CE} = 6 \text{ V}$; $f = 1 \text{ kHz}$)

h_{fe}	75 (≥ 40)	-
----------	------------------	---

Transition frequency

($I_C = 20 \text{ mA}$; $V_{CE} = 6 \text{ V}$; $f = 200 \text{ MHz}$)

f_T	5	GHz
-------	---	-----

Reverse transfer capacitance

($I_C = 1 \text{ mA}$; $V_{CE} = 6 \text{ V}$; $f = 1 \text{ MHz}$)

C_{12e}	0.45 (≤ 0.65)	pF
-----------	-------------------------	----

Noise figure

($I_C = 2 \text{ mA}$; $V_{CE} = 6 \text{ V}$; $f = 200 \text{ MHz}$; $R_g = 75 \Omega$)

NF	2	dB
----	---	----

($I_C = 3 \text{ mA}$; $V_{CE} = 10 \text{ V}$; $f = 2 \text{ GHz}$; $Z_g = Z_{g \text{ opt}}$)

NF	3.8 (≤ 5)	dB
----	------------------	----

Power gain

($I_C = 15 \text{ mA}$; $V_{CE} = 10 \text{ V}$; $f = 2 \text{ GHz}$)

$G_{pe \text{ opt}}$	12 (≥ 10)	dB
----------------------	------------------	----

S parameterOperating point: $V_{CE} = 8 \text{ V}$, $I_C = 3 \text{ mA}$, $Z_o = 50 \Omega$

f (GHz)	S_{11}	φ	S_{21}	φ	S_{12}	φ	S_{22}	φ
0,1	0,867	- 25	8,47	160	0,018	74	0,987	- 10
0,2	0,839	- 50	7,91	144	0,033	59	0,916	- 20
0,3	0,809	- 70	7,06	131	0,043	48	0,857	- 28
0,4	0,775	- 86	6,23	120	0,049	39	0,801	- 33
0,5	0,750	- 99	5,49	110	0,055	32	0,758	- 37
0,6	0,725	-111	5,00	102	0,059	26	0,730	- 41
0,7	0,704	-119	4,51	95	0,063	23	0,734	- 44
0,8	0,695	-128	4,07	88	0,064	21	0,697	- 47
0,9	0,684	-135	3,69	83	0,065	17	0,682	- 52
1,0	0,667	-141	3,33	78	0,064	15	0,679	- 54
1,1	0,684	-145	3,03	73	0,065	13	0,662	- 57
1,2	0,672	-148	2,80	68	0,064	11	0,663	- 62
1,3	0,664	-153	2,59	64	0,066	8	0,664	- 64
1,4	0,660	-155	2,43	59	0,067	7	0,662	- 66
1,5	0,636	-160	2,28	55	0,063	6	0,656	- 69
1,6	0,652	-162	2,16	53	0,063	5	0,685	- 73
1,7	0,642	-165	2,02	49	0,065	5	0,705	- 74
1,8	0,649	-167	1,97	44	0,065	5	0,688	- 76
1,9	0,623	-168	1,87	40	0,065	4	0,678	- 79
2,0	0,604	-172	1,78	36	0,066	3	0,699	- 83
2,5	0,637	159	1,60	22	0,080	0	0,587	- 86
3,0	0,611	149	1,38	7	0,086	-2	0,610	- 99
3,5	0,602	135	1,20	-9	0,095	-5	0,618	-117
4,0	0,564	125	1,06	-25	0,103	-12	0,657	-128
4,5	0,544	110	0,97	-40	0,112	-18	0,661	-142
5,0	0,517	101	0,86	-55	0,120	-24	0,700	-156

S parameterOperating point: $V_{CE} = 8 \text{ V}$, $I_C = 5 \text{ mA}$, $Z_0 = 50 \Omega$

f (GHz)	S_{11}	φ	S_{21}	φ	S_{12}	φ	S_{22}	φ
0,1	0,801	- 32	13,05	156	0,017	67	0,968	- 13
0,2	0,762	- 62	11,73	137	0,030	54	0,861	- 25
0,3	0,731	- 84	10,03	124	0,038	44	0,779	- 33
0,4	0,706	-102	8,53	112	0,042	36	0,717	- 38
0,5	0,681	-114	7,31	103	0,045	30	0,669	- 42
0,6	0,660	-125	6,45	95	0,049	25	0,646	- 46
0,7	0,644	-133	5,78	88	0,050	24	0,650	- 49
0,8	0,639	-141	5,14	82	0,052	22	0,616	- 51
0,9	0,629	-146	4,62	77	0,052	20	0,605	- 56
1,0	0,619	-152	4,14	73	0,053	19	0,603	- 58
1,1	0,633	-155	3,76	68	0,054	17	0,590	- 61
1,2	0,617	-158	3,46	63	0,054	16	0,606	- 66
1,3	0,611	-162	3,19	59	0,055	14	0,605	- 67
1,4	0,609	-163	2,98	55	0,057	13	0,608	- 70
1,5	0,583	-167	2,79	51	0,056	13	0,603	- 72
1,6	0,598	-169	2,63	48	0,056	14	0,630	- 76
1,7	0,588	-171	2,46	44	0,058	13	0,653	- 77
1,8	0,596	-172	2,34	40	0,060	12	0,640	- 79
1,9	0,549	-174	2,20	37	0,060	12	0,637	- 83
2,0	0,553	-177	2,10	32	0,062	11	0,660	- 86
2,5	0,605	155	1,94	22	0,078	11	0,511	- 84
3,0	0,570	144	1,65	7	0,090	7	0,542	- 97
3,5	0,573	132	1,45	-9	0,100	0	0,551	-114
4,0	0,523	121	1,28	-24	0,111	-6	0,597	-126
4,5	0,512	107	1,18	-39	0,123	-14	0,607	-140
5,0	0,475	97	1,04	-55	0,131	-21	0,653	-153

S parameterOperating point: $V_{CE} = 8 \text{ V}$, $I_C = 10 \text{ mA}$, $Z_o = 50 \Omega$

f (GHz)	S_{11}	φ	S_{21}	φ	S_{12}	φ	S_{22}	φ
0,1	0,674	- 47	22,16	149	0,015	60	0,915	- 19
0,2	0,647	- 85	17,96	128	0,025	50	0,759	- 32
0,3	0,623	-110	14,25	114	0,029	40	0,652	- 39
0,4	0,614	-125	11,44	103	0,032	37	0,590	- 43
0,5	0,604	-135	9,55	95	0,034	33	0,546	- 45
0,6	0,593	-144	8,22	88	0,036	31	0,526	- 48
0,7	0,583	-150	7,22	82	0,038	31	0,530	- 50
0,8	0,587	-157	6,42	77	0,040	31	0,507	- 52
0,9	0,575	-161	5,71	73	0,042	31	0,505	- 56
1,0	0,570	-165	5,09	69	0,044	30	0,510	- 58
1,1	0,583	-167	4,62	64	0,045	30	0,495	- 61
1,2	0,564	-170	4,23	60	0,047	28	0,512	- 65
1,3	0,563	-173	3,90	55	0,049	27	0,517	- 66
1,4	0,560	-172	3,64	52	0,051	26	0,524	- 69
1,5	0,534	-177	3,41	48	0,051	28	0,523	- 71
1,6	0,547	-178	3,20	46	0,054	27	0,554	- 75
1,7	0,534	179	3,00	42	0,055	26	0,576	- 75
1,8	0,540	179	2,85	38	0,058	24	0,568	- 77
1,9	0,514	178	2,68	34	0,059	24	0,567	- 81
2,0	0,499	174	2,54	30	0,063	22	0,595	- 84
2,5	0,583	149	2,26	21	0,080	20	0,435	- 83
3,0	0,551	139	1,94	6	0,094	14	0,472	- 94
3,5	0,554	128	1,70	-9	0,106	6	0,493	-113
4,0	0,501	117	1,50	-24	0,119	-1	0,538	-123
4,5	0,489	103	1,38	-39	0,132	-10	0,552	-138
5,0	0,447	93	1,21	-55	0,142	-19	0,604	-151

S parameterOperating point: $V_{CE} = 8 \text{ V}$, $I_C = 15 \text{ mA}$, $Z_0 = 50 \Omega$

f (GHz)	S_{11}	φ	S_{21}	φ	S_{12}	φ	S_{22}	φ
0,1	0,588	- 61	28,31	144	0,013	62	0,874	- 22
0,2	0,586	-102	21,63	121	0,021	47	0,691	- 35
0,3	0,582	-125	16,07	108	0,024	41	0,582	- 40
0,4	0,583	-138	12,63	99	0,026	40	0,529	- 43
0,5	0,580	-146	10,44	91	0,028	36	0,499	- 45
0,6	0,573	-154	8,87	85	0,031	37	0,477	- 47
0,7	0,565	-159	7,78	79	0,033	36	0,486	- 49
0,8	0,568	-164	6,82	74	0,036	38	0,466	- 50
0,9	0,559	-168	6,09	70	0,039	37	0,466	- 55
1,0	0,557	-172	5,45	66	0,041	37	0,475	- 56
1,1	0,569	-173	4,93	62	0,042	36	0,462	- 59
1,2	0,552	-175	4,52	58	0,044	36	0,483	- 64
1,3	0,550	-178	4,14	54	0,046	34	0,489	- 65
1,4	0,542	-177	3,88	50	0,049	33	0,494	- 67
1,5	0,516	177	3,62	47	0,049	34	0,501	- 69
1,6	0,528	176	3,39	44	0,052	34	0,528	- 73
1,7	0,518	175	3,18	40	0,055	32	0,554	- 74
1,8	0,525	174	3,01	36	0,059	30	0,545	- 75
1,9	0,497	174	2,84	33	0,060	29	0,545	- 79
2,0	0,487	170	2,70	29	0,063	27	0,574	- 83
2,5	0,578	146	2,37	20	0,080	26	0,418	- 80
3,0	0,550	138	2,04	6	0,094	19	0,455	- 93
3,5	0,551	126	1,77	-9	0,107	10	0,469	-110
4,0	0,504	115	1,57	-25	0,120	1	0,525	-121
4,5	0,489	101	1,43	-39	0,135	-7	0,539	-135
5,0	0,445	91	1,27	-55	0,146	-16	0,595	-149

Total perm. power dissipation versus temperature

$P_{tot} = f(T_{amb})$

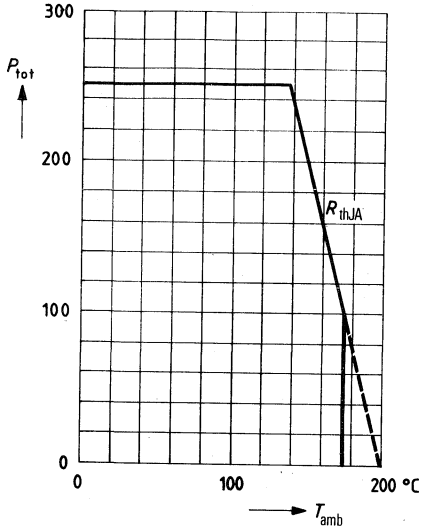

Max. power gain

$G_{pe\ opt} = f(I_C)$
 $V_{CE} = 10\ V; f = 2\ GHz$

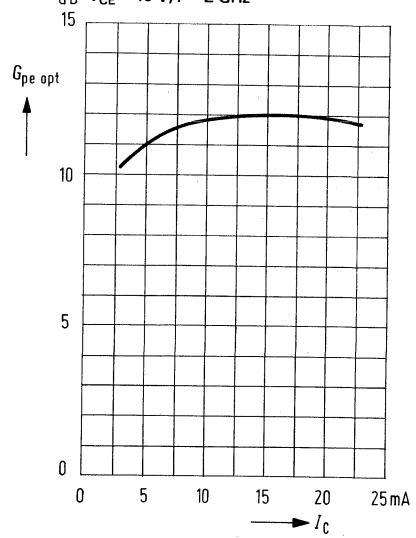

Output power $P_o = f(I_C)$

at 1 dB gain compression
 $V_{CE} = 10\ V; f = 2\ GHz$

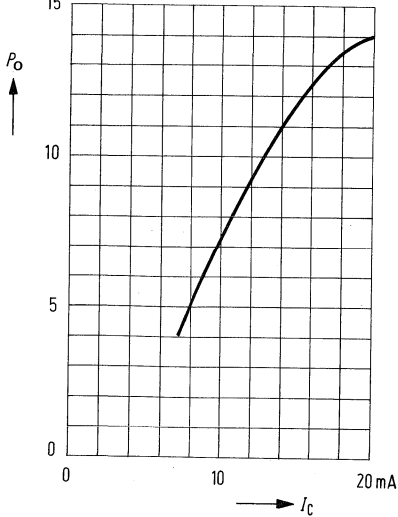

Oscillator output power

$P_{osc} = f(I_C); V_{CE} = 10\ V;$
 $mW; f = 4\ GHz; Y_L = 20\ mS$

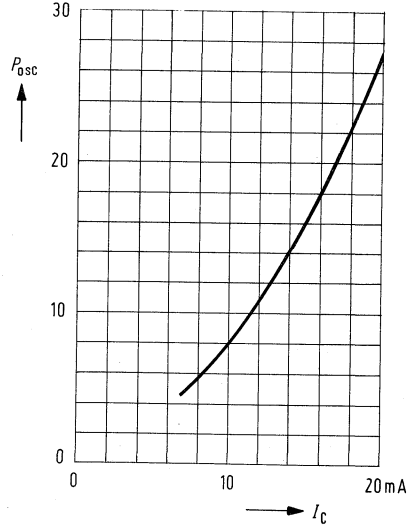

Min. noise figure

$$NF_{min} = f(I_C) \text{ at } Y_S = Y_{opt}$$

$$V_{CE} = 10 \text{ V}; f = 2 \text{ GHz}$$

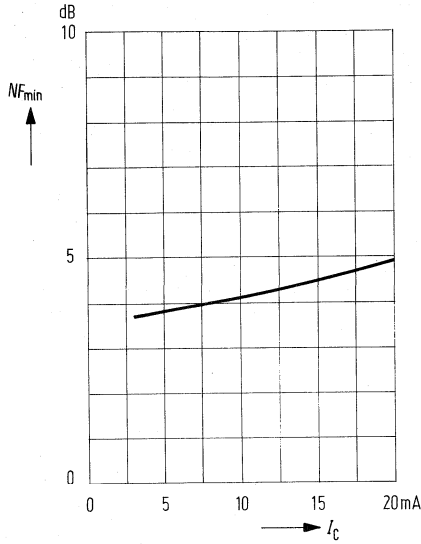

Equivalent noise resistance

$$R_n = f(I_C)$$

$$NF = NF_{min} + R_n \frac{|Y_s - Y_{opt}|^2}{R_o(Y_s)}$$

$$V_{CE} = 10 \text{ V}; f = 2 \text{ GHz}$$

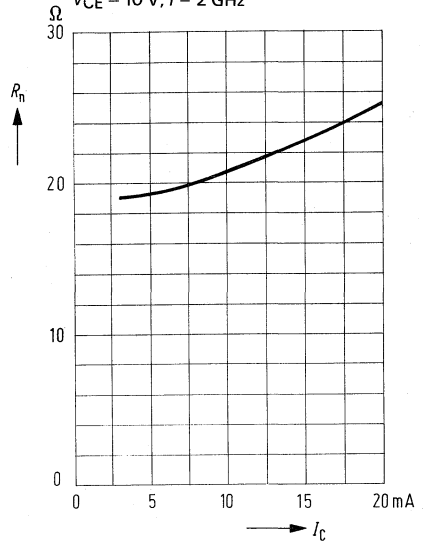

Optimum generator admittance

$$Y_{opt} = f(I_C) \text{ for } NF = NF_{min}$$

$$Y_{opt} = G_{opt} + j h_{FE opt}; V_{CE} = 10 \text{ V};$$

$$f = 2 \text{ GHz}; Y_o = 20 \text{ mS}$$

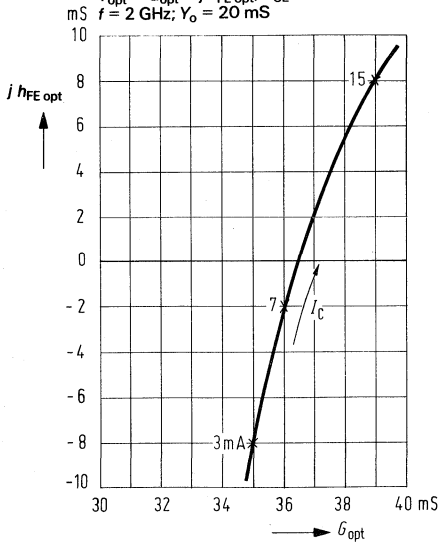

Intermodulation damping

$$d_{IM} = f(I_C); V_{CE} = 10 \text{ V};$$

$$f_1 = 2 \text{ GHz}; f_2 = 2,003 \text{ GHz};$$

$$Y_s = Y_L = 20 \text{ mS}; P_{O1} = P_{O2} = 0,23 \text{ mW}$$

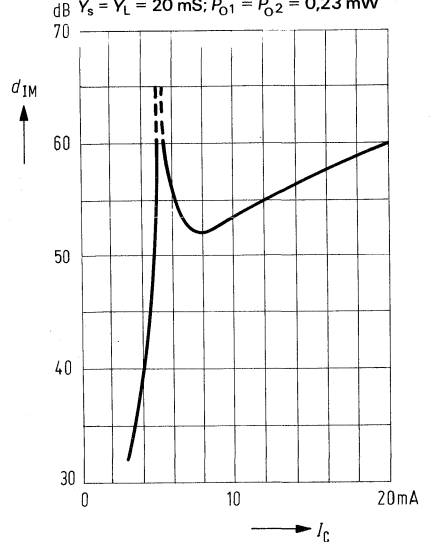

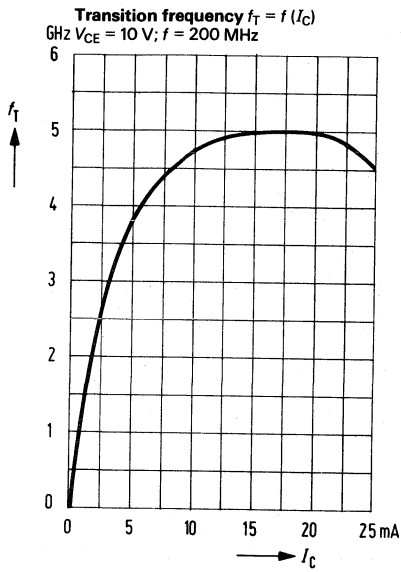

BFR 14 B is an epitaxial NPN silicon planar microwave transistor in hermetically sealed metal ceramic 100 mil package similar to TO 120. Because of its low noise figure, high gain, and low distortion, the transistor is particularly intended for use in low-noise input stages, broadband, IF, and radar amplifiers up to 4 GHz, as well as for oscillator circuits of low performance up to 6 GHz.

The ceramic package is especially suitable for thin and thick film circuits and permits Space applications. The emitter terminal is connected to the package. The transistor is marked on its package with the short designation "14 B".

Type	Mark	Ordering code
BFR 14 B	14 B	Q62702-F494

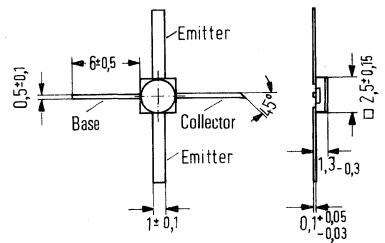

Approx. weight 0.05 g Dimensions in mm

Maximum ratings

Collector-emitter voltage	V_{CE0}	12	V
Collector-base voltage	V_{CBO}	20	V
Collector-emitter voltage ($R_{BE} \leq 50 \Omega$)	V_{CER}	20	V
Emitter-base voltage	V_{EBO}	2.5	V
Collector current	I_C	30	mA
Base current	I_B	4	mA
Junction temperature	T_j	200	°C
Storage temperature range	T_{stg}	-65 to +175	°C
Total power dissipation ($T_{amb} \leq 137^\circ\text{C}$)	P_{tot}	250	mW

Thermal resistance

Junction to ambient air when mounted on Al_2O_3 ceramics 16x25x0.6 mm or glass-fiber reinforced Teflon 40x25x1.5 mm	R_{thJA}	≤ 250	K/W
---	------------	------------	-----

Static characteristics ($T_{amb} = 25^{\circ}\text{C}$)

Collector-emitter breakdown voltage ($I_{CEO} = 500 \mu\text{A}$)	$V_{(BR)CEO}$	≥ 12	V
Collector-emitter breakdown voltage ($I_{CER} = 10 \text{ mA}; R_{BE} = 50 \Omega$)	$V_{(BR)CER}$	≥ 20	V
Emitter-base breakdown voltage ($I_{EBO} = 100 \mu\text{A}$)	$V_{(BR)EBO}$	≥ 2.5	V
Collector cutoff current ($V_{CBO} = 10 \text{ V}$)	I_{CBO}	< 50	nA
($V_{CBO} = 10 \text{ V}; T_{amb} = 150^{\circ}\text{C}$)	I_{CBO}	< 50	μA
Collector cutoff current ($V_{CB} = 20 \text{ V}; V_{BE} = 0$)	I_{CES}	< 100	μA
DC current gain ($I_C = 5 \text{ mA}; V_{CE} = 6 \text{ V}$)	h_{FE}	> 30	—

Dynamic characteristics ($T_{amb} = 25^{\circ}\text{C}$)

Small signal current gain ($I_C = 20 \text{ mA}; V_{CE} = 6 \text{ V}; f = 1 \text{ kHz}$)	h_{fe}	75 (≥ 35)	—
($I_C = 20 \text{ mA}; V_{CE} = 6 \text{ V}; f = 1 \text{ kHz}$)	h_{fe}	75 (≥ 35)	—
Transition frequency ($I_C = 20 \text{ mA}; V_{CE} = 6 \text{ V}; f = 200 \text{ MHz}$)	f_T	6	GHz
Reverse transfer capacitance ($I_C = 1 \text{ mA}; V_{CE} = 6 \text{ V}; f = 1 \text{ MHz}$)	C_{12e}	0.45 (≤ 0.65)	pF
Noise figure ($I_C = 2 \text{ mA}; V_{CE} = 10 \text{ V};$ $f = 200 \text{ MHz}; R_g = 100 \Omega$)	NF	1.5 (≤ 2)	dB
($I_C = 3 \text{ mA}; V_{CE} = 10 \text{ V};$ $f = 2 \text{ GHz}; Z_g = Z_{g \text{ opt}}$)	NF	3.2 (≤ 4)	dB
Power gain ($I_C = 15 \text{ mA}; V_{CE} = 10 \text{ V};$ $f = 2 \text{ GHz}$)	$G_{pe \text{ opt}}$	12.5 (≥ 11)	dB

S parameterOperating point: $V_{CE} = 10\text{ V}$, $I_C = 3\text{ mA}$, $Z_o = 50\ \Omega$

f (GHz)	S_{11}	φ	S_{21}	φ	S_{12}	φ	S_{22}	φ	G_{\max} (dB)
0,1	0,859	- 18	6,96	164	0,018	76	1,018	- 7	-
0,2	0,855	- 34	6,90	153	0,032	66	0,946	-14	32,2
0,3	0,796	- 49	6,53	141	0,045	57	0,879	-21	27,1
0,4	0,767	- 65	6,17	131	0,054	51	0,806	-28	24,2
0,5	0,726	- 77	5,68	124	0,061	45	0,800	-31	22,8
0,6	0,700	- 92	5,36	116	0,067	40	0,721	-33	20,7
0,7	0,650	-104	5,00	108	0,071	35	0,721	-37	19,5
0,8	0,644	-116	4,66	101	0,074	31	0,677	-36	18,4
0,9	0,602	-128	4,42	94	0,076	28	0,602	-42	16,8
1,0	0,610	-136	4,11	88	0,078	26	0,653	-44	16,7
1,1	0,568	-147	3,89	83	0,080	24	0,586	-42	15,3
1,2	0,610	-153	3,61	78	0,080	23	0,566	-50	14,9
1,3	0,553	-160	3,37	74	0,081	21	0,563	-49	13,8
1,4	0,605	-167	3,16	70	0,082	19	0,558	-53	13,6
1,5	0,552	-170	2,94	65	0,081	19	0,542	-49	12,5
1,6	0,569	-176	2,83	62	0,081	19	0,537	-56	12,2
1,7	0,542	179	2,63	58	0,082	19	0,543	-54	11,4
1,8	0,568	172	2,51	54	0,082	19	0,534	-59	11,2
1,9	0,565	168	2,42	51	0,084	18	0,530	-57	10,8
2,0	0,562	163	2,33	47	0,085	19	0,512	-64	10,3

Operating point: $V_{CE} = 10\text{ V}$, $I_C = 10\text{ mA}$, $Z_o = 50\ \Omega$

0,1	0,647	- 35	18,73	155	0,014	69	0,959	-14	38,7
0,2	0,604	- 69	17,15	137	0,023	55	0,800	-25	31,1
0,3	0,551	- 97	14,60	122	0,029	49	0,680	-31	27,6
0,4	0,535	-116	12,38	111	0,033	45	0,589	-37	25,2
0,5	0,509	-132	10,52	104	0,036	44	0,578	-37	23,5
0,6	0,512	-143	9,06	97	0,039	44	0,509	-37	21,8
0,7	0,492	-154	7,98	90	0,042	43	0,512	-39	20,6
0,8	0,497	-162	7,11	85	0,044	43	0,473	-35	19,4
0,9	0,492	-172	6,36	80	0,047	43	0,414	-41	18,1
1,0	0,509	-175	5,82	76	0,050	43	0,478	-43	17,7
1,1	0,493	175	5,34	72	0,053	43	0,422	-38	16,6
1,2	0,527	174	4,91	68	0,056	43	0,410	-48	16,0
1,3	0,489	167	4,50	65	0,058	43	0,412	-46	15,1
1,4	0,546	165	4,17	62	0,061	42	0,414	-51	14,8
1,5	0,494	161	3,88	58	0,063	43	0,405	-46	13,8
1,6	0,517	158	3,69	56	0,066	43	0,399	-54	13,4
1,7	0,494	154	3,46	53	0,070	45	0,413	-50	12,8
1,8	0,531	150	3,26	49	0,073	44	0,401	-56	12,5
1,9	0,523	148	3,14	46	0,076	43	0,404	-53	12,1
2,0	0,525	144	3,00	44	0,080	43	0,388	-61	11,6

S parameter

Operating point: $V_{CE} = 10\text{ V}$, $I_C = 20\text{ mA}$, $Z_o = 50\ \Omega$

f (GHz)	S_{11}	φ	S_{21}	φ	S_{12}	φ	S_{22}	φ	G_{max} (dB)
0,1	0,478	- 62	27,67	146	0,011	65	0,897	-18	37,0
0,2	0,491	-108	21,99	123	0,018	53	0,699	-26	31,0
0,3	0,492	-133	16,91	110	0,021	51	0,585	-29	27,6
0,4	0,495	-148	13,37	101	0,024	50	0,514	-33	25,1
0,5	0,495	-160	10,97	95	0,027	51	0,521	-31	23,4
0,6	0,508	-166	9,20	90	0,030	52	0,470	-31	21,7
0,7	0,498	-174	8,01	84	0,033	53	0,485	-33	20,5
0,8	0,503	-179	7,08	79	0,036	54	0,462	-28	19,3
0,9	0,510	172	6,30	75	0,039	53	0,405	-35	18,1
1,0	0,520	171	5,74	71	0,043	54	0,472	-37	17,6
1,1	0,514	163	5,26	68	0,047	54	0,427	-32	16,6
1,2	0,542	163	4,83	65	0,050	53	0,410	-42	16,0
1,3	0,512	156	4,41	61	0,053	54	0,419	-40	15,1
1,4	0,565	157	4,07	58	0,055	54	0,422	-46	14,7
1,5	0,515	152	3,80	55	0,058	53	0,421	-41	13,8
1,6	0,536	150	3,60	52	0,063	54	0,411	-49	13,4
1,7	0,515	146	3,38	49	0,066	54	0,430	-46	12,8
1,8	0,552	143	3,20	46	0,071	52	0,418	-52	12,5
1,9	0,545	141	3,06	43	0,074	52	0,422	-49	12,1
2,0	0,548	138	2,93	41	0,078	52	0,404	-57	11,7

Min. noise figure $NF_{min} = f(I_C)$

$V_{CE} = 10\text{ V}$; $f = 2\text{ GHz}$

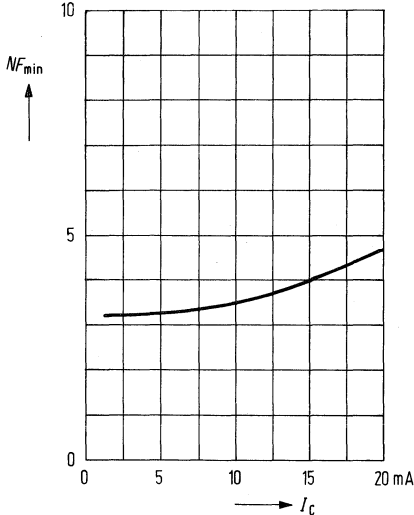

Max. pp power gain $G_{pe\ opt} = f(I_C)$

$V_{CE} = 10\text{ V}$; $f = 2\text{ GHz}$

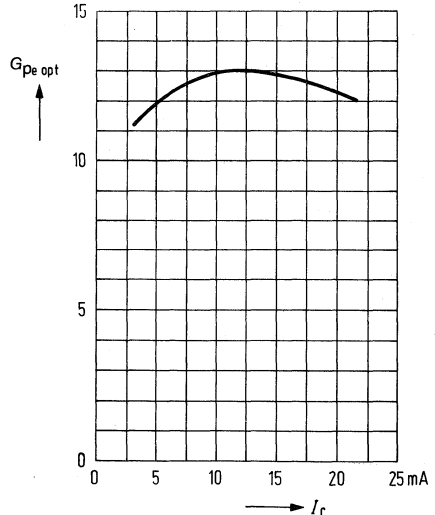

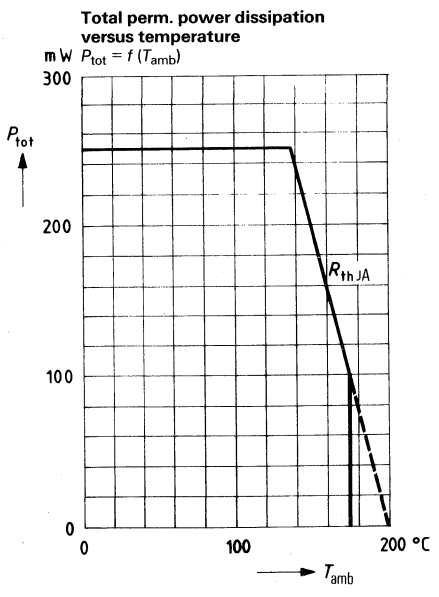
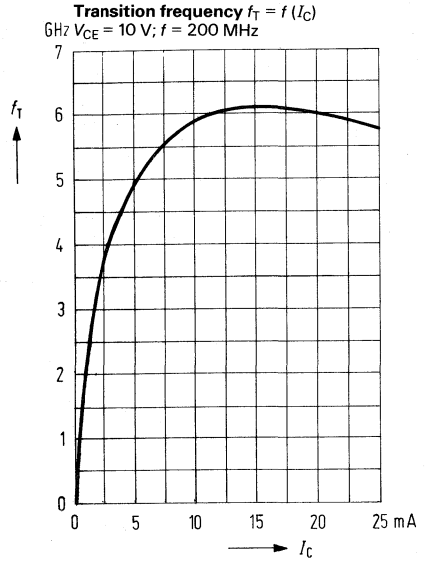
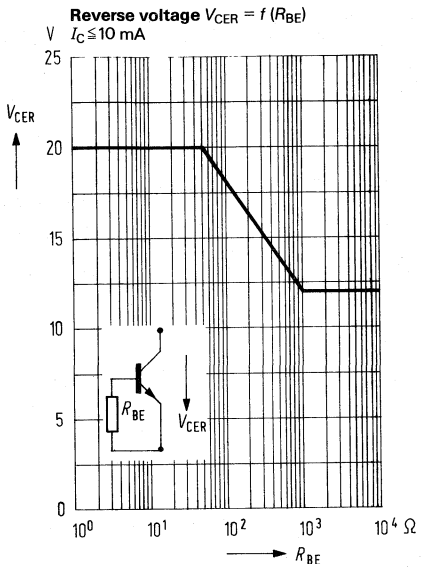

BFR 14 C is an epitaxial NPN silicon planar microwave transistor in hermetically sealed metal ceramic 200 mil package similar to TO 120. It is outstanding for a low noise figure, high power gain and low distortion factor. It is intended for use in low-noise RF input stages, broadband IF, and radar amplifiers up to 4 GHz, as well as for smaller oscillator circuits up to 6 GHz.

The 200 mil ceramic package is particularly suitable for use in thin and thick film circuits for aircraft and Space applications. The emitter is electrically connected to the package. The transistor is marked on its package with the short designation "14 C".

Type	Mark	Ordering code
BFR 14 C	14 C	Q62702-F543

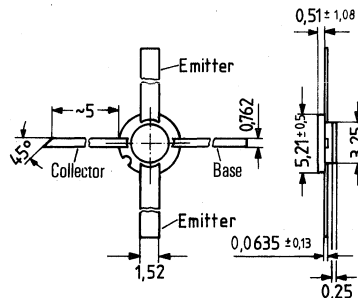

Approx. weight 0.08 g Dimensions in mm

Maximum ratings ($T_{amb} = 25^{\circ}\text{C}$)

Collector-emitter voltage	V_{CEO}	20	V
Collector-base voltage	V_{CBO}	27	V
Collector-emitter voltage ($R_{BE} \leq 50 \Omega$)	V_{CER}	27	V
Emitter-base voltage	V_{EBO}	1.5	V
Collector current	I_C	35	mA
Base current	I_B	4	mA
Junction temperature	T_j	200	$^{\circ}\text{C}$
Storage temperature range	T_{stg}	-65 to +175	$^{\circ}\text{C}$
Total power dissipation ($T_{amb} \leq 150^{\circ}\text{C}$)	P_{tot}	700	mW

Thermal resistance

Junction to case	R_{thJC}	≤ 70	K/W
------------------	------------	-----------	-----

Static characteristics ($T_{amb} = 25^{\circ}\text{C}$)

Collector-emitter breakdown voltage

($I_{CEO} = 1\text{ mA}$)

$V_{(BR)CEO}$	≥ 20	V
---------------	-----------	---

Collector-emitter breakdown voltage

($I_{CER} = 10\text{ mA}$; $R_{BE} = 50\ \Omega$)

$V_{(BR)CER}$	≥ 27	V
---------------	-----------	---

Emitter-base breakdown voltage

($I_{EBO} = 100\ \mu\text{A}$)

$V_{(BR)EBO}$	≥ 1.5	V
---------------	------------	---

Collector cutoff current

($V_{CBO} = 10\text{ V}$)

I_{CBO}	< 50	nA
-----------	--------	----

Collector cutoff current

($V_{CBO} = 10\text{ V}$; $T_{amb} = 150^{\circ}\text{C}$)

I_{CBO}	< 50	μA
-----------	--------	---------------

Collector cutoff current

($V_{CBO} = 25\text{ V}$)

I_{CES}	< 100	μA
-----------	---------	---------------

DC current gain

($I_C = 15\text{ mA}$; $V_{CE} = 10\text{ V}$)

h_{FE}	> 30	-
----------	--------	---

Dynamic characteristics ($T_{amb} = 25^{\circ}\text{C}$)

Small-signal current gain

($I_C = 15\text{ mA}$; $V_{CB} = 10\text{ V}$; $f = 1\text{ kHz}$)

h_{fe}	75	-
----------	----	---

Transition frequency

($I_C = 15\text{ mA}$; $V_{CE} = 10\text{ V}$; $f = 200\text{ MHz}$)

f_T	4.3	GHz
-------	-----	-----

Reverse transfer capacitance

($I_C = 1\text{ mA}$; $V_{CE} = 10\text{ V}$; $f = 1\text{ MHz}$)

C_{12e}	0.45 (≤ 0.65)	pF
-----------	----------------------	----

Noise figure

($I_C = 2\text{ mA}$; $V_{CE} = 10\text{ V}$; $f = 10\text{ MHz}$; $R_g = 75\ \Omega$)

NF	1.5 (≤ 2)	dB
----	------------------	----

($I_C = 5\text{ mA}$; $V_{CE} = 10\text{ V}$; $f = 2\text{ GHz}$; $Z_g = Z_{g\text{ opt.}}$)

NF	3.6 (≤ 4.5)	dB
----	--------------------	----

Power gain

($I_C = 15\text{ mA}$; $V_{CE} = 10\text{ V}$; $f = 2\text{ GHz}$)

$G_{pe\text{ opt.}}$	11	dB
----------------------	----	----

S parameterOperating point: $V_{CE} = 10 \text{ V}$, $I_C = 3 \text{ mA}$, $Z_o = 50 \Omega$

f (GHz)	S_{11}	φ	S_{21}	φ	S_{12}	φ	S_{22}	φ	G_{\max} (dB)
0,1	0,884	- 18	6,93	163	0,017	77	1,018	- 7	-
0,2	0,872	- 34	6,78	151	0,030	66	0,943	-13	32,4
0,3	0,806	- 48	6,36	140	0,042	57	0,865	-19	26,6
0,4	0,767	- 63	5,97	130	0,050	52	0,805	-27	23,9
0,5	0,718	- 75	5,43	123	0,056	46	0,823	-27	22,8
0,6	0,685	- 88	5,09	115	0,061	42	0,732	-28	20,2
0,7	0,624	- 99	4,71	107	0,066	38	0,740	-33	19,0
0,8	0,611	-109	4,38	100	0,069	36	0,711	-31	17,9
0,9	0,562	-121	4,13	94	0,072	33	0,634	-36	16,2
1,0	0,567	-127	3,82	89	0,074	32	0,702	-39	16,3
1,1	0,508	-138	3,60	84	0,076	31	0,647	-35	14,8
1,2	0,559	-144	3,33	79	0,077	30	0,617	-44	14,2
1,3	0,491	-148	3,11	76	0,078	28	0,631	-43	13,3
1,4	0,533	-157	2,91	72	0,080	27	0,627	-46	12,9
1,5	0,481	-158	2,71	67	0,079	27	0,618	-44	11,9
1,6	0,494	-166	2,61	64	0,081	27	0,608	-50	11,5
1,7	0,464	-168	2,44	61	0,082	27	0,621	-48	10,9
1,8	0,475	-176	2,33	57	0,084	28	0,616	-52	10,5
1,9	0,477	-179	2,24	54	0,086	27	0,619	-50	10,2
2,0	0,467	176	2,16	51	0,089	28	0,599	-56	9,7

Operating point: $V_{CE} = 10 \text{ V}$; $I_C = 10 \text{ mA}$, $Z_o = 50 \Omega$

0,1	0,703	- 38	18,63	152	0,013	69	0,947	-14	38,2
0,2	0,631	- 73	16,57	132	0,022	53	0,787	-21	30,8
0,3	0,554	- 99	13,71	117	0,027	49	0,671	-25	26,9
0,4	0,520	-118	11,28	107	0,030	48	0,610	-31	24,4
0,5	0,490	-133	9,42	100	0,032	46	0,628	-28	22,9
0,6	0,484	-143	8,01	94	0,035	47	0,561	-26	20,9
0,7	0,458	-153	7,00	88	0,039	48	0,579	-31	19,7
0,8	0,459	-160	6,27	83	0,042	48	0,574	-26	18,7
0,9	0,453	-169	5,60	79	0,044	48	0,502	-31	17,2
1,0	0,464	-170	5,10	75	0,048	48	0,580	-35	17,0
1,1	0,441	179	4,68	71	0,051	49	0,537	-29	15,8
1,2	0,481	179	4,29	68	0,054	49	0,510	-39	15,1
1,3	0,430	172	3,94	65	0,057	49	0,531	-38	14,2
1,4	0,489	171	3,64	62	0,059	49	0,532	-42	13,9
1,5	0,434	167	3,39	59	0,062	48	0,533	-39	13,0
1,6	0,457	164	3,22	56	0,066	49	0,528	-45	12,6
1,7	0,425	161	3,02	53	0,069	50	0,547	-43	12,0
1,8	0,454	156	2,87	50	0,073	49	0,540	-48	11,6
1,9	0,450	154	2,74	47	0,076	49	0,548	-45	11,3
2,0	0,444	151	2,64	45	0,080	49	0,529	-51	10,8

S parameter

Operating point: $V_{CE} = 10\text{ V}$; $I_C = 20\text{ mA}$, $Z_o = 50\ \Omega$

f (GHz)	S_{11}	φ	S_{21}	φ	S_{12}	φ	S_{22}	φ	G_{max} (dB)
0,1	0,536	- 69	26,19	141	0,010	61	0,879	-15	36,3
0,2	0,517	-155	19,25	117	0,016	49	0,709	-19	30,1
0,3	0,496	-137	14,19	105	0,019	52	0,624	-20	26,4
0,4	0,494	-151	11,05	97	0,021	52	0,584	-24	23,9
0,5	0,489	-161	8,96	92	0,024	54	0,625	-22	22,4
0,6	0,495	-166	7,48	87	0,027	56	0,571	-21	20,4
0,7	0,481	-173	6,53	82	0,031	58	0,595	-26	19,3
0,8	0,484	-178	5,79	78	0,033	57	0,603	-22	18,4
0,9	0,490	174	5,13	74	0,036	58	0,535	-26	16,9
1,0	0,495	175	4,66	70	0,040	58	0,613	-31	16,6
1,1	0,482	165	4,27	67	0,043	59	0,575	-26	15,5
1,2	0,516	167	3,91	64	0,047	58	0,546	-35	14,7
1,3	0,473	161	3,59	61	0,050	59	0,569	-35	13,9
1,4	0,532	161	3,31	58	0,053	59	0,573	-38	13,6
1,5	0,478	157	3,08	54	0,055	58	0,577	-36	12,7
1,6	0,499	155	2,93	52	0,059	59	0,565	-42	12,2
1,7	0,471	152	2,74	49	0,063	59	0,586	-41	11,7
1,8	0,498	148	2,60	47	0,067	58	0,583	-46	11,3
1,9	0,497	146	2,50	44	0,071	58	0,594	-43	11,1
2,0	0,492	144	2,39	41	0,076	58	0,572	-49	10,5

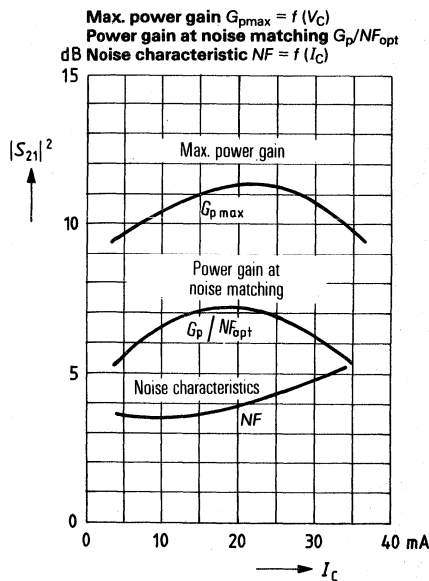
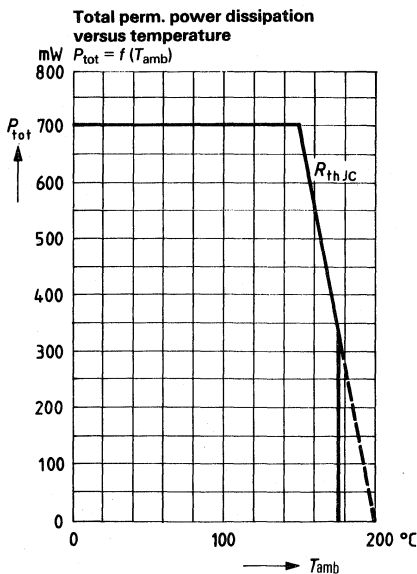

NPN Silicon Transistor for Low-Noise RF Broadband Amplifiers

BFR 15 A

BFR 15 A is an epitaxial NPN silicon planar RF transistor in TO 72 case (18 A 4 DIN 41876) for universal application up to the GHz range, e. g. for low-noise broadband and antenna amplifiers.

The terminals E, B, and C are insulated from the case.

Type	Ordering code
BFR 15A	Q62702-F460

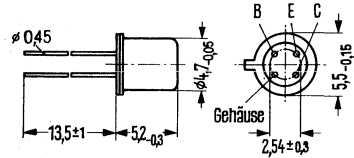

Approx. weight 0.4 g Dimensions in mm

Maximum ratings

Collector-emitter voltage	V_{CE0}	12	V
Collector-emitter voltage ($R_{BE} \leq 50 \Omega$)	V_{CER}	20	V
Emitter-base voltage	V_{EBO}	2.5	V
Collector current	I_C	30	mA
Base current	I_B	4	mA
Junction temperature	T_j	200	$^{\circ}\text{C}$
Storage temperature range	T_{stg}	-65 to +175	$^{\circ}\text{C}$
Total power dissipation ($T_{amb} \leq 60^{\circ}\text{C}$)	P_{tot}	200	mW

Thermal resistance

Junction to ambient air	R_{thJA}	≤ 700	K/W
Junction to case	R_{thJC}	≤ 400	K/W

Static characteristics ($T_{amb} = 25^{\circ}\text{C}$)

Collector-emitter breakdown voltage ($I_{CEO} = 500 \mu\text{A}$)	$V_{(BR)CEO}$	> 12	V
Collector-emitter breakdown voltage ($I_{CER} = 10 \text{ mA}; R_{BE} = 50 \Omega$)	$V_{(BR)CER}$	> 20	V
Emitter-base breakdown voltage ($I_{EBO} = 100 \mu\text{A}$)	$V_{(BR)EBO}$	> 2.5	V
Collector cutoff current ($V_{CBO} = 10 \text{ V}$)	I_{CBO}	< 50	nA
DC current gain ($I_C = 5 \text{ to } 20 \text{ mA}; V_{CE} = 6 \text{ V}$)	h_{FE}	≥ 25	-

Dynamic characteristics ($T_{amb} = 25^{\circ}\text{C}$)

Small signal current gain ($I_C = 5 \text{ mA}; V_{CE} = 6 \text{ V}; f = 1 \text{ kHz}$)	h_{fe}	70	-
Transition frequency ($I_C = 10 \text{ mA}; V_{CE} = 6 \text{ V}; f = 200 \text{ MHz}$)	f_T	4.5	GHz
Reverse transfer capacitance ($I_C = 1 \text{ mA}; V_{CE} = 6 \text{ V}; f = 1 \text{ MHz}$)	C_{12e}	0.42	pF
Collector-base capacitance ($V_{CBO} = 10 \text{ V}; f = 1 \text{ MHz}$)	C_{CBO}	≤ 1.1	pF
Noise figure ($I_C = 2 \text{ mA}; V_{CE} = 6 \text{ V}; f = 10 \text{ MHz}; R_g = 75 \Omega$)	NF	1.8	dB
($I_C = 2 \text{ mA}; V_{CE} = 6 \text{ V}; f = 200 \text{ MHz}; R_g = 75 \Omega$)	NF	2	dB
($I_C = 2 \text{ mA}; V_{CE} = 6 \text{ V}; f = 800 \text{ MHz}; R_g = 60 \Omega$)	NF	3	dB
Power gain ($I_C = 10 \text{ mA}; V_{CE} = 6 \text{ V}; f = 800 \text{ MHz}; R_g = 60 \Omega$)	G_{pe}	12	dB
Output voltage (three tone modulation f approx. 800 MHz) ($I_C = 15 \text{ mA}; V_{CE} = 5 \text{ V}; d_{IM} = 60 \text{ dB}$ $R_L = R_g = 75 \Omega$)	V_0	140	mV

S parameterOperating point: $V_{CE} = 6 \text{ V}$, $I_C = 12 \text{ mA}$, $Z_o = 50 \Omega$

f (GHz)	S_{11}	φ	S_{21}	φ	S_{12}	φ	S_{22}	φ	G_{\max} (dB)
0,1	0,565	-27	16,71	134	0,022	74	0,804	-12	30,64
0,2	0,383	-31	11,36	118	0,039	79	0,696	-13	24,68
0,3	0,273	-30	8,22	109	0,056	80	0,628	-11	20,81
0,4	0,214	-25	6,32	104	0,071	83	0,567	-10	17,90
0,5	0,160	-19	5,21	100	0,088	84	0,562	-13	16,10
0,6	0,127	-18	4,45	97	0,107	84	0,566	-13	14,72
0,7	0,117	-18	3,78	95	0,119	85	0,562	-11	13,27
0,8	0,127	-12	3,36	92	0,136	85	0,531	-10	12,00
0,9	0,140	-7	2,91	90	0,148	85	0,533	-16	10,82
1,0	0,173	-1	2,62	87	0,162	83	0,577	-17	10,27
1,1	0,204	-1	2,35	84	0,173	81	0,628	-17	9,78
1,2	0,275	0	2,06	82	0,179	80	0,601	-19	8,57
1,3	0,344	4	1,80	78	0,183	76	0,667	-23	8,24
1,4	0,412	5	1,58	74	0,187	70	0,714	-26	7,88
1,5	0,483	6	1,38	72	0,191	68	0,735	-25	7,33

Total perm. power dissipation versus temperature

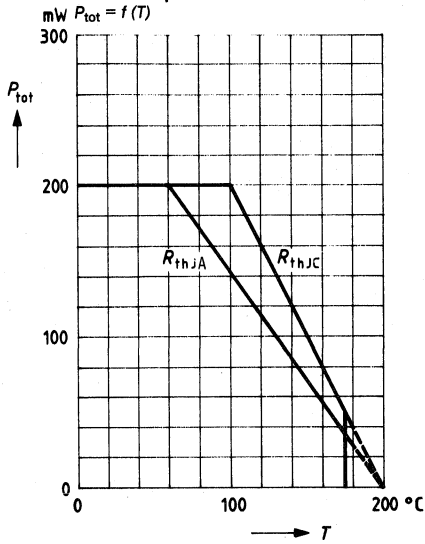

Transition frequency $f_T = f(I_C)$

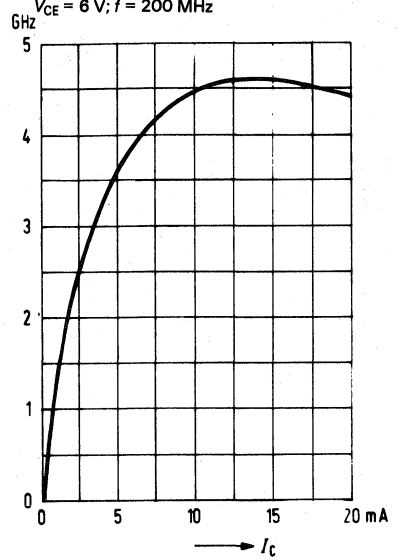

Noise figure $NF = f(I_C)$

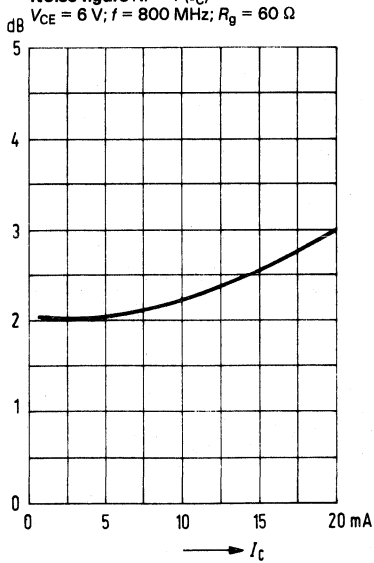

BFR 34 A is an epitaxial NPN silicon planar RF transistor in a plastic package similar to TO 119 (50 B 3 DIN 41867) intended for use in RF amplifiers up to the GHz range, e. g. for low-noise input stages, broadband antenna amplifiers and oscillators. BFR 34 A is also available upon request as JEDEC type under the designation 2N6620.

Type	Ordering code
BFR 34 A 2N 6620	Q62702-F346-S1 Q68000-A4668

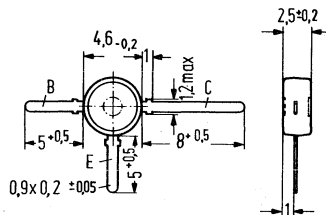

Approx. weight 0.25 g Dimensions in mm

Maximum ratings

- Collector-emitter voltage
- Collector-emitter voltage ($R_{BE} \leq 50 \Omega$)
- Emitter-base voltage
- Collector current
- Base current
- Junction temperature
- Storage temperature range
- Total power dissipation ($T_{amb} \leq 50^\circ\text{C}$)

	BFR 34 A 2 N 6620	
V_{CEO}	12	V
V_{CER}	20	V
V_{EBO}	2.5	V
I_C	30	mA
I_B	4	mA
T_j	150	$^\circ\text{C}$
T_{stg}	-55 to +125	$^\circ\text{C}$
P_{tot}	200	mW

Thermal resistance

- Junction to ambient air
(mounted on glass fiber epoxy resin PCB
40 mm x 25 mm x 1.5 mm)

R_{thJA}	≤ 500	K/W
------------	------------	-----

Static characteristics ($T_{amb} = 25^{\circ}\text{C}$)

	BFR 34 A 2 N 6620	
Collector-emitter breakdown voltage ($I_{CEO} = 500 \mu\text{A}$)	$V_{(BR)CEO}$	> 12 V
Collector-emitter breakdown voltage ($I_{CER} = 10 \text{ mA}$; $R_{BE} = 50 \Omega$)	$V_{(BR)CER}$	> 20 V
Emitter-base breakdown voltage ($I_{EBO} = 100 \mu\text{A}$)	$V_{(BR)EBO}$	> 2.5 V
Collector cutoff current ($V_{CBO} = 10 \text{ V}$)	I_{CBO}	< 50 nA
DC current gain ($I_C = 5 \text{ to } 25 \text{ mA}$; $V_{CE} = 6 \text{ V}$)	h_{FE}	≥ 25 -

Dynamic characteristics ($T_{amb} = 25^{\circ}\text{C}$)

Small signal current gain ($I_C = 5 \text{ mA}$; $V_{CE} = 6 \text{ V}$; $f = 1 \text{ kHz}$)	h_{fe}	70 -
Transition frequency ($I_C = 200 \text{ mA}$; $V_{CE} = 10 \text{ V}$; $f = 200 \text{ MHz}$)	f_T	5 GHz
Reverse transfer capacitance ($I_C = 1 \text{ mA}$; $V_{CE} = 6 \text{ V}$; $f = 1 \text{ MHz}$)	C_{12e}	0.4 pF
Collector-base capacitance ($V_{CBO} = 10 \text{ V}$, $f = 1 \text{ MHz}$)	C_{CBO}	0.75 pF
Noise figure ($I_C = 2 \text{ mA}$; $V_{CE} = 6 \text{ V}$; $f = 10 \text{ MHz}$; $R_g = 75 \Omega$)	NF	1.8 dB
($I_C = 2 \text{ mA}$; $V_{CE} = 6 \text{ V}$; $f = 200 \text{ MHz}$; $R_g = 75 \Omega$)	NF	2 dB
($I_C = 2 \text{ mA}$; $V_{CE} = 6 \text{ V}$; $f = 800 \text{ MHz}$; $R_g = 60 \Omega$)	NF	2 dB
($I_C = 3 \text{ mA}$; $V_{CE} = 10 \text{ V}$; $f = 2 \text{ GHz}$; $Z_g = Z_{g \text{ opt}}$)	NF	4 dB
Power gain ($I_C = 15 \text{ mA}$; $V_{CE} = 6 \text{ V}$; $f = 800 \text{ MHz}$; $R_g = 60 \Omega$)	G_{pe}	14 dB
Output voltage (three tone modulation f approx. 800 MHz) ($I_C = 15 \text{ mA}$, $V_{CE} = 6 \text{ V}$; $d_{IM} = 60 \text{ dB}$; $R_g = R_L = 75 \Omega$)	V_O	140 mV

S parameter

Operating point: $V_{CE} = 6 \text{ V}$, $I_C = 5 \text{ mA}$, $Z_o = 50 \Omega$

f (GHz)	S_{11}	φ	S_{21}	φ	S_{12}	φ	S_{22}	φ
0,1	0,794	- 27	13,08	153	0,021	75	0,930	-13
0,2	0,663	- 52	11,38	136	0,037	62	0,843	-20
0,3	0,535	- 71	9,11	121	0,047	58	0,697	-27
0,4	0,420	- 89	7,70	110	0,054	57	0,691	-27
0,5	0,385	-103	6,50	103	0,062	58	0,595	-26
0,6	0,306	-113	5,57	97	0,068	58	0,577	-30
0,7	0,287	-131	4,95	91	0,076	58	0,546	-31
0,8	0,272	-138	4,35	86	0,084	58	0,539	-33
0,9	0,254	-153	3,96	83	0,089	60	0,543	-34
1,0	0,264	-158	3,51	79	0,095	60	0,520	-33
1,1	0,256	-169	3,29	75	0,104	60	0,502	-37
1,2	0,268	-175	3,03	72	0,111	61	0,504	-38
1,3	0,271	177	2,82	69	0,120	61	0,488	-42
1,4	0,280	171	2,60	66	0,125	60	0,508	-42
1,5	0,236	158	2,30	62	0,121	53	0,439	-46
1,6	0,314	165	2,36	60	0,139	62	0,467	-46
1,7	0,328	161	2,21	59	0,148	64	0,469	-46
1,8	0,345	157	2,07	54	0,154	61	0,439	-50
1,9	0,354	156	1,99	52	0,162	62	0,452	-53
2,0	0,374	153	1,90	49	0,169	60	0,435	-55

Total perm. power dissipation versus temperature

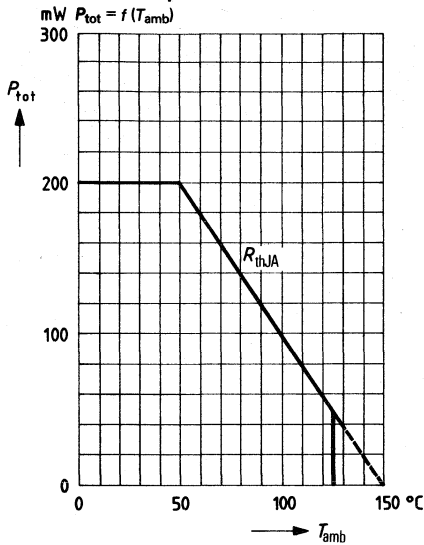

Transition frequency $f_T = f(I_C)$

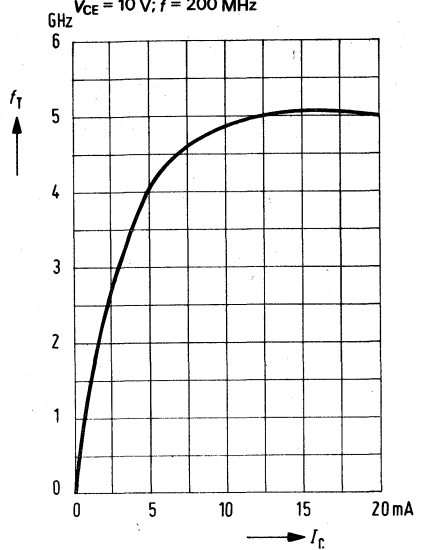

Noise figure $NF = f(I_C)$

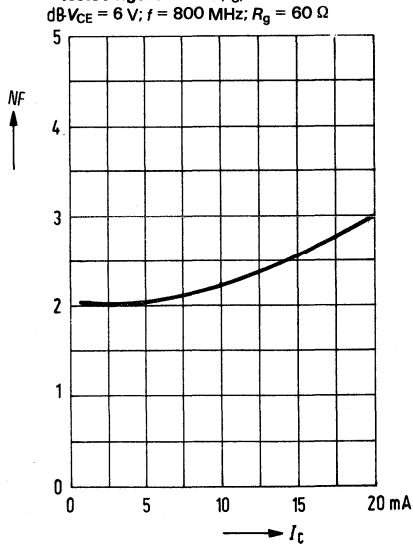

Noise figure $NF = f(f)$

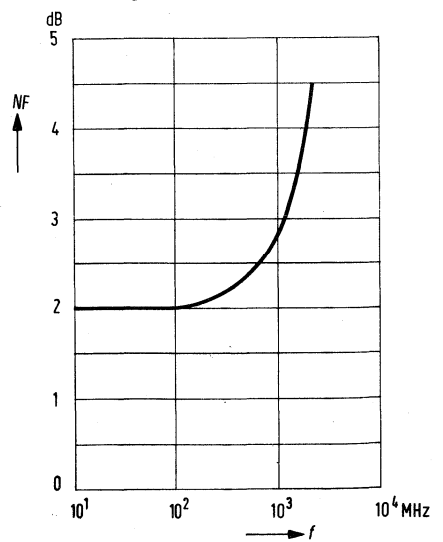

NPN Silicon Transistor for Low-Noise RF Broadband Amplifiers and High-Speed Switching Applications

BFR 35 A
BFR 35 AR
2 N 6619

BFR 35 A is an epitaxial NPN silicon planar RF transistor in TO 236 plastic package (23 A 3 DIN 41869), intended for use in film circuits up to the GHz range, e. g. for broadband amplifiers and ultrafast, unsaturated logic circuits. The transistor BFR 35 A is marked with the code letters "GB". The transistor is also available upon request with changed terminal sequence ("E" and "B" interchanged) under the designation BFR 35 AR (mark "GZ"). The BFR 35 A is also available upon request as JEDEC type, designated 2N6619,

Type	Mark	Ordering code
BFR 35 A	GB	Q62702-F347-S1
BFR 35 AR	GZ	Q62702-F500
2 N 6619	GB	Q68000-A4667

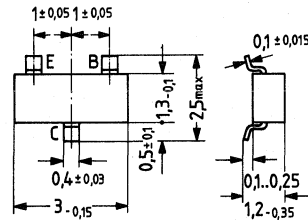

Approx. weight 0.02 g Dimensions in mm

Maximum ratings

Collector-emitter voltage
 Collector-emitter voltage ($R_{BE} \leq 50 \Omega$)
 Emitter-base voltage
 Collector current
 Base current
 Junction temperature
 Storage temperature range
 Total power dissipation ($T_{amb} \leq 50^\circ\text{C}$)

	BFR 35 A 2 N 6619	
V_{CEO}	12	V
V_{CER}	20	V
V_{EBO}	2.5	V
I_C	30	mA
I_B	4	mA
T_j	150	$^\circ\text{C}$
T_{stg}	-55 to +125	$^\circ\text{C}$
P_{tot}	200	mW

Thermal resistance

Junction to ambient air
 Junction to substrate back
 (ceramic substrate 0.7 mm; 2.5 cm² area)

R_{thJA}	< 500	K/W
R_{thJSB}	< 400	K/W

Static characteristics ($T_{amb} = 25^{\circ}\text{C}$)

Collector-emitter breakdown voltage

($I_{CEO} = 500 \mu\text{A}$)

		BFR 35 A	
		2 N 6619	
$V_{(BR)CEO}$	> 12	V	
$V_{(BR)CER}$	> 20	V	
$V_{(BR)EBO}$	> 2.5	V	
I_{CBO}	< 50	nA	
h_{FE}	> 25	-	

Collector-emitter breakdown voltage

($I_{CER} = 10 \text{ mA}$; $R_{BE} = 50 \Omega$)

Emitter-base breakdown voltage

($I_{EBO} = 100 \mu\text{A}$)

Collector cutoff current

($V_{CBO} = 10 \text{ V}$)

DC current gain

($I_C = 5 \text{ to } 20 \text{ mA}$; $V_{CE} = 6 \text{ V}$)

Dynamic characteristics ($T_{amb} = 25^{\circ}\text{C}$)

Small-signal current gain

($I_C = 5 \text{ mA}$; $V_{CE} = 6 \text{ V}$; $f = 1 \text{ kHz}$)

h_{fe} 70 -

Transition frequency

($I_C = 20 \text{ mA}$; $V_{CE} = 10 \text{ V}$; $f = 200 \text{ MHz}$)

f_T 5 GHz

Reverse transfer capacitance

($I_C = 1 \text{ mA}$; $V_{CE} = 6 \text{ V}$; $f = 1 \text{ MHz}$)

C_{12e} 0.4 pF

Collector-base capacitance

($V_{CBO} = 10 \text{ V}$; $f = 1 \text{ MHz}$)

C_{CBO} 0.7 pF

Noise figure

($I_C = 2 \text{ mA}$; $V_{CE} = 6 \text{ V}$; $f = 200 \text{ MHz}$; $R_g = 75 \Omega$)

NF 2 dB

($I_C = 2 \text{ mA}$; $V_{CE} = 6 \text{ V}$; $f = 800 \text{ MHz}$; $R_g = 60 \Omega$)

NF 2 dB

($I_C = 3 \text{ mA}$; $V_{CE} = 10 \text{ V}$; $f = 2 \text{ GHz}$; $R_g = R_{g \text{ opt}}$)

NF 4 dB

Power gain

($I_C = 15 \text{ mA}$; $V_{CE} = 6 \text{ V}$; $f = 800 \text{ MHz}$;

$R_g = 60 \Omega$)

G_{pe} 14 dB

Output voltage:

(three tone modulation f approx. 800 MHz)

($I_C = 15 \text{ mA}$; $V_{CE} = 6 \text{ V}$;

$d_{IM} = 60 \text{ dB}$; $R_g = R_L = 75 \Omega$)

V_0 140 mV

S parameter

Operating point: $V_{CE} = 6 \text{ V}$, $I_C = 5 \text{ mA}$, $Z_o = 50 \Omega$

f (GHz)	S_{11}	φ	S_{21}	φ	S_{12}	φ	S_{22}	φ
0,1	0,771	- 29	12,75	150	0,025	73	0,971	-14
0,2	0,639	- 55	10,70	130	0,041	63	0,807	-21
0,3	0,486	- 72	8,34	115	0,052	57	0,697	-27
0,4	0,400	- 87	6,92	104	0,063	57	0,650	-26
0,5	0,326	- 97	5,78	97	0,071	57	0,582	-29
0,6	0,289	-105	4,88	91	0,079	57	0,591	-31
0,7	0,232	-112	4,30	85	0,089	56	0,585	-25
0,8	0,206	-123	3,79	80	0,098	56	0,501	-27
0,9	0,180	-129	3,47	76	0,109	57	0,527	-34
1,0	0,168	-142	3,12	73	0,116	57	0,560	-31
1,1	0,151	-146	2,88	68	0,125	56	0,505	-29
1,2	0,124	-163	2,65	64	0,136	55	0,512	-39
1,3	0,131	-174	2,50	60	0,147	54	0,541	-35
1,4	0,124	173	2,34	57	0,157	54	0,474	-36
1,5	0,128	164	2,20	53	0,167	53	0,521	-45
1,6	0,132	148	2,08	49	0,174	51	0,539	-38
1,7	0,160	142	1,98	47	0,188	51	0,425	-40
1,8	0,158	140	1,83	43	0,192	49	0,460	-60
1,9	0,160	131	1,81	40	0,207	47	0,586	-51
2,0	0,180	123	1,73	37	0,216	47	0,480	-43

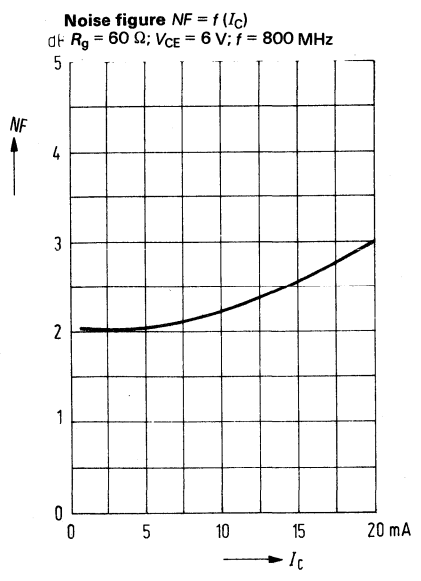
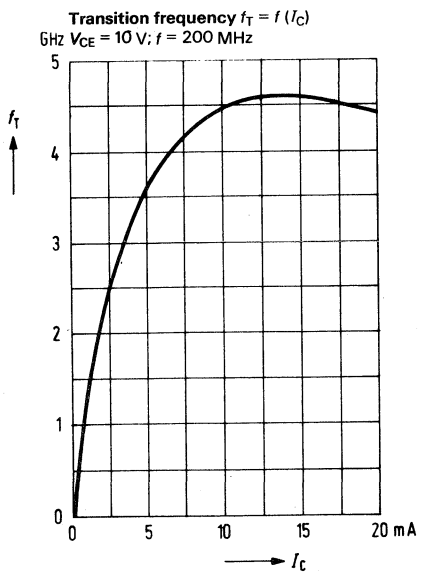
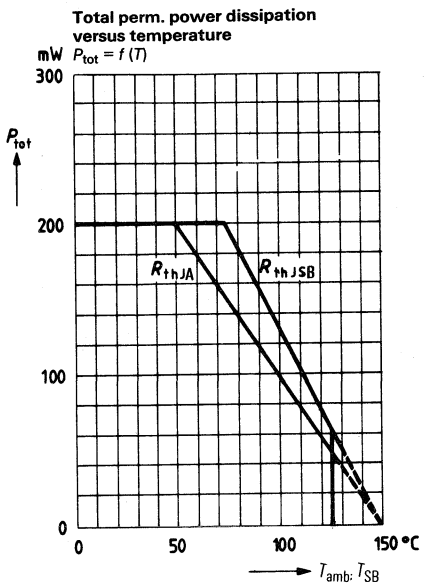

NPN Silicon Transistor for Low-Noise RF Broadband Amplifier Applications

BFR 90

BFR 90 is an epitaxial NPN silicon planar RF transistor in a plastic package similar to TO 119 (50 B 3 DIN 41867), intended for use in RF amplifiers up to the GHz range, e. g. for low-noise input stages, broadband antenna amplifiers, and oscillators.

Type	Ordering code
BFR 90	Q62702-F560

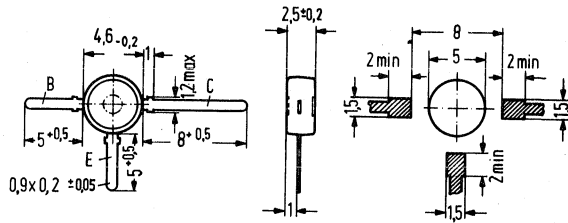

Approx. weight 0.25 g

Dimensions in mm

Maximum ratings

Collector-emitter voltage	V_{CEO}	15	V
Collector-emitter voltage ($R_{BE} \leq 50 \Omega$)	V_{CER}	20	V
Emitter-base voltage	V_{EBO}	2.5	V
Collector current	I_C	30	mA
Base current	I_B	4	mA
Junction temperature	T_j	150	°C
Storage temperature range	T_{stg}	-55 to +125	°C
Total power dissipation ($T_{amb} \leq 60^\circ\text{C}$)	P_{tot}	200	mW

Thermal resistance

Junction to ambient air
mounted on glass fiber epoxy resin PCB
40 mm x 25 mm x 1.5 mm

R_{thJA}	≤ 500	K/W
------------	------------	-----

Static characteristics ($T_{amb} = 25^{\circ}\text{C}$)

Collector-emitter breakdown voltage ($I_{CEO} = 500 \mu\text{A}$)	$V_{(BR)CEO}$	> 15	V
Collector-emitter breakdown voltage ($I_{CER} = 10 \text{ mA}$; $R_{BE} = 50 \Omega$)	$V_{(BR)CER}$	> 20	V
Emitter-base breakdown voltage ($I_{EBO} = 100 \mu\text{A}$)	$V_{(BR)EBO}$	> 2.5	V
Collector cutoff current ($V_{CBO} = 10 \text{ V}$)	I_{CBO}	< 50	nA
DC current gain ($I_C = 5 \text{ to } 25 \text{ mA}$; $V_{CE} = 6 \text{ V}$)	h_{FE}	≥ 25	—

Dynamic characteristics ($T_{amb} = 25^{\circ}\text{C}$)

Small-signal current gain ($I_C = 5 \text{ mA}$; $V_{CE} = 6 \text{ V}$; $f = 1 \text{ kHz}$)	h_{fe}	70	—
Transition frequency ($I_C = 20 \text{ mA}$; $V_{CE} = 10 \text{ V}$; $f = 200 \text{ MHz}$)	f_T	5	GHz
Reverse transfer capacitance ($I_C = 1 \text{ mA}$; $V_{CE} = 6 \text{ V}$; $f = 1 \text{ MHz}$)	C_{12e}	0.4	pF
Collector-base capacitance ($V_{CBO} = 10 \text{ V}$; $f = 1 \text{ MHz}$)	C_{CBO}	0.75	pF
Noise figure ($I_C = 2 \text{ mA}$; $V_{CE} = 6 \text{ V}$; $f = 200 \text{ MHz}$; $R_g = 100 \Omega$)	NF	2	dB
($I_C = 2 \text{ mA}$; $V_{CE} = 6 \text{ V}$; $f = 800 \text{ MHz}$; $R_g = 60 \Omega$)	NF	2	dB
($I_C = 3 \text{ mA}$; $V_{CE} = 10 \text{ V}$; $f = 2 \text{ GHz}$; $Z_g = Z_{g \text{ opt}}$)	NF	4	dB
Power gain ($I_C = 15 \text{ mA}$; $V_{CE} = 6 \text{ V}$; $f = 800 \text{ MHz}$; $R_g = 60 \Omega$)	G_{pe}	14	dB
Output voltage: (three tone modulation f approx. 800 MHz) ($I_C = 15 \text{ mA}$; $V_{CE} = 6 \text{ V}$; $d_{iM} = 60 \text{ dB}$; $R_L = R_g = 75 \Omega$)	V_o	140	mV

S parameter

Operating point: $V_{CE} = 6\text{ V}$, $I_C = 15\text{ mA}$, $Z_o = 50\ \Omega$

f (GHz)	S_{11}	φ	S_{21}	φ	S_{12}	φ	S_{22}	φ
0,1	0,300	- 35	19,93	146	0,015	78	0,894	-16
0,2	0,201	- 65	14,93	123	0,027	73	0,695	-21
0,3	0,139	- 89	11,26	110	0,038	72	0,558	-29
0,4	0,103	-109	8,90	102	0,047	76	0,584	-33
0,5	0,077	-131	7,23	97	0,058	76	0,599	-25
0,6	0,074	-160	6,14	92	0,068	75	0,492	-21
0,7	0,068	177	5,39	87	0,079	75	0,476	-32
0,8	0,063	162	4,67	34	0,091	73	0,531	-33
0,9	0,113	160	4,31	31	0,101	76	0,487	-23
1,0	0,114	153	3,88	78	0,111	74	0,467	-33
1,1	0,123	143	3,55	75	0,120	74	0,472	-34
1,2	0,143	137	3,27	72	0,131	72	0,451	-36
1,3	0,161	133	2,35	70	0,142	72	0,445	-36
1,4	0,187	131	2,36	63	0,154	72	0,440	-42
1,5	0,195	130	2,66	65	0,161	71	0,444	-42
1,6	0,213	127	2,53	63	0,173	70	0,433	-43
1,7	0,214	127	2,38	61	0,182	69	0,427	-44
1,8	0,244	123	2,25	58	0,191	69	0,337	-50
1,9	0,265	123	2,15	56	0,200	67	0,494	-53
2,0	0,253	126	2,08	53	0,212	65	0,394	-51

Total perm. power dissipation versus temperature

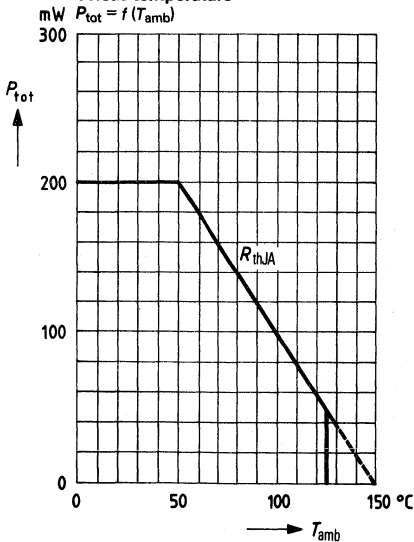

BFR 91 is an epitaxial NPN silicon planar RF transistor in a plastic package similar to TO 119 (50 B 3, DIN 41867), intended for application in driver stages of antenna amplifiers up to the GHz range, e. g. for low-noise input and driver stages of antenna amplifiers.

Type	Ordering code
BFR 91	Q62702-F559

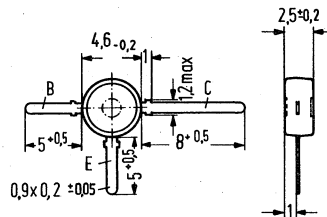

Approx. weight 0.25 g Dimensions in mm

Maximum ratings

Collector-emitter voltage
 Collector-emitter voltage ($R_{BE} \leq 50 \Omega$)
 Emitter-base voltage
 Collector current
 Base current
 Junction temperature
 Storage temperature range
 Total power dissipation ($T_{amb} \leq 50^\circ\text{C}$)

V_{CEO}	15	V
V_{CER}	20	V
V_{EBO}	2.5	V
I_C	50	mA
I_B	10	mA
T_j	150	$^\circ\text{C}$
T_{stg}	-55 to +125	$^\circ\text{C}$
P_{tot}	250	mW

Thermal resistance

Junction to ambient air
 mounted on glass fiber epoxy resin PCB
 40 mm x 25 mm x 1.5 mm

R_{thJA}	≤ 400	K/W
------------	------------	-----

Static characteristics ($T_{amb} = 25^{\circ}\text{C}$)

Collector-emitter breakdown voltage ($I_C = 0.5\text{ mA}$; $I_B = 0$)	$V_{(BR)CEO}$	> 15	V
Collector-emitter breakdown voltage ($I_C = 10\text{ mA}$; $R_{BE} = 50\ \Omega$)	$V_{(BR)CER}$	> 20	V
Emitter-base breakdown voltage ($I_E = 0.1\text{ mA}$; $I_C = 0$)	$V_{(BR)EBO}$	> 2.5	V
Collector cutoff current ($V_C = 10\text{ V}$; $I_E = 0$)	I_{CBO}	< 50	nA
DC current gain ($I_C = 25\text{ mA}$; $V_{CE} = 8\text{ V}$)	h_{FE}	> 30	-
($I_C = 50\text{ mA}$; $V_{CE} = 5\text{ V}$)	h_{FE}	> 30	-

Dynamic characteristics ($T_{amb} = 25^{\circ}\text{C}$)

Small signal current gain ($I_C = 25\text{ mA}$; $V_{CE} = 8\text{ V}$; $f = 1\text{ kHz}$)	h_{fe}	80	-
Transition frequency ($f = 200\text{ MHz}$; $I_C = 25\text{ mA}$; $V_{CE} = 8\text{ V}$)	f_T	5	GHz
Reverse transfer capacitance ($f = 1\text{ MHz}$; $I_C = 1\text{ mA}$; $V_{CE} = 8\text{ V}$)	C_{12e}	0.65	pF
Output capacitance ($f = 1\text{ MHz}$; $V_{CBO} = 8\text{ V}$)	C_{CBO}	0.85	pF
Noise figure ($I_C = 2\text{ mA}$; $V_{CE} = 8\text{ V}$; $f = 500\text{ MHz}$; $R_g = R_{g\text{ opt.}}$)	NF	1.9	dB
Power gain ($I_C = 30\text{ mA}$; $V_{CE} = 5\text{ V}$; $f = 500\text{ MHz}$; $R_g = 60\ \Omega$)	G_{pe}	17	dB
Output voltage: (three tone modulation f approx. 800 MHz) $I_C = 25\text{ mA}$; $V_{CE} = 8\text{ V}$; $R_C = R_L = 75\ \Omega$; $d_{IM} = 60\text{ dB}$)	V_L	350	mV

S parameter

Operating point: $V_{CE} = 5\text{ V}$, $I_C = 30\text{ mA}$, $Z_0 = 50\ \Omega$

f (GHz)	S_{11}	φ	S_{21}	φ	S_{12}	φ	S_{22}	φ	$G_{max.}$ (dB)
0,1	0,353	-107	27,43	120	0,020	61	0,553	-42	30,93
0,2	0,329	-144	15,97	103	0,033	68	0,385	-46	25,26
0,3	0,329	-160	10,79	95	0,044	69	0,296	-41	21,56
0,4	0,335	-169	8,25	88	0,057	69	0,241	-42	19,11
0,5	0,338	-176	6,65	84	0,070	70	0,220	-48	17,20
0,6	0,345	176	5,61	81	0,084	72	0,234	-50	15,78
0,7	0,356	171	4,81	78	0,095	71	0,221	-43	14,45
0,8	0,364	168	4,18	74	0,107	70	0,176	-48	13,18
0,9	0,370	165	3,74	71	0,119	69	0,193	-63	12,27
1,0	0,378	162	3,35	67	0,131	68	0,213	-58	11,38

**Total perm. power dissipation
versus temperature**

$P_{tot} = f(T_{amb})$

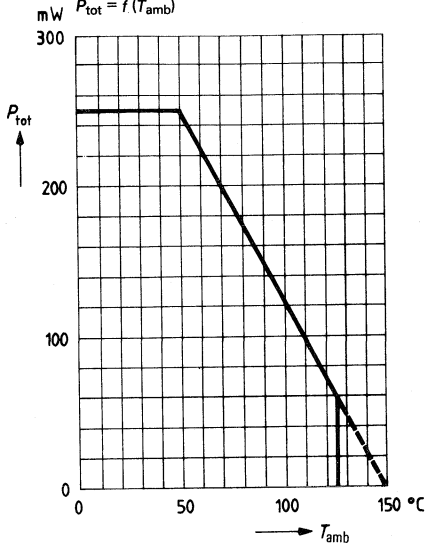

NPN Silicon Planar Transistors for Low Noise RF Broadband Amplifiers

BFR 92
BFR 93

BFR 92 and BFR 93 are epitaxial NPN silicon planar RF transistors in TO 236 plastic package (23 A 3 DIN 41869), intended for use in film circuits up to the GHz range; BFR 93 e. g. for use in broadband amplifiers. The transistor is marked "R 1".

BFR 92 is suitable e. g. for low-noise input and intermediate stages in high Q antenna and broadband amplifiers. It is marked "P 1".

Type	Mark	Ordering code
BFR 92	P1	Q68000-A1103
BFR 93	R1	Q62702-F561

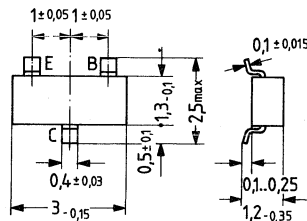

Approx. weight 0.02 g Dimensions in mm

Maximum ratings

		BFR 92	BFR 93	
Collector-emitter voltage	V_{CE0}	15	15	V
Collector-emitter voltage ($R_{BE} \leq 50 \Omega$)	V_{CER}	20	20	V
Emitter-base voltage	V_{EBO}	2.5	2.5	V
Collector current	I_C	30	50	mA
Base current	I_B	4	10	mA
Junction temperature	T_j	150	150	°C
Storage temperature range	T_{stg}	-55 to +125	-55 to +125	°C
Total power dissipation ($T_{amb} \leq 50^\circ\text{C}$) ¹⁾	P_{tot}	200	200	mW

Thermal resistance

Junction to ambient air	R_{thJA}	≤ 500	≤ 500	K/W
Junction to substrate back ¹⁾	R_{thJSB}	≤ 400	≤ 400	K/W

1) Ceramic substrate 0.7 mm; 2.5 cm² area.

Static characteristics ($T_{amb} = 25\text{ }^{\circ}\text{C}$)

Collector-emitter breakdown voltage

($I_{CEO} = 500\text{ }\mu\text{A}$)

	BFR 92	BFR 93		
$V_{(BR)CEO}$	> 15	—	V	
Collector-emitter breakdown voltage ($I_{CER} = 10\text{ mA}$; $R_{BE} = 50\text{ }\Omega$)	$V_{(BR)CER}$	> 20	—	V
Emitter-base breakdown voltage ($I_{EBO} = 100\text{ }\mu\text{A}$)	$V_{(BR)EBO}$	> 2.5	—	V
Collector cutoff current ($V_{CBO} = 10\text{ V}$)	I_{CBO}	≤ 50	≤ 50	nA
Collector cutoff current ($V_{CE} = 20\text{ V}$; $V_{BE} = 0$)	I_{CES}	—	≤ 100	μA
DC current gain ($I_C = 5\text{ to }20\text{ mA}$; $V_{CE} = 6\text{ V}$)	h_{FE}	≥ 25	—	—
($I_C = 50\text{ mA}$; $V_{CE} = 5\text{ V}$)	h_{FE}	—	≥ 30	—

Dynamic characteristics ($T_{amb} = 25\text{ }^{\circ}\text{C}$)

Small-signal current gain

($I_C = 5\text{ mA}$; $V_{CE} = 6\text{ V}$; $f = 1\text{ kHz}$)

($I_C = 25\text{ mA}$; $V_{CE} = 8\text{ V}$; $f = 1\text{ kHz}$)

Transition frequency

($I_C = 20\text{ mA}$; $V_{CE} = 10\text{ V}$; $f = 200\text{ MHz}$)

($I_C = 50\text{ mA}$; $V_{CE} = 5\text{ V}$; $f = 200\text{ MHz}$)

Reverse transfer capacitance

($I_C = 1\text{ mA}$; $V_{CE} = 6\text{ V}$; $f = 1\text{ MHz}$)

($I_C = 1\text{ mA}$; $V_{CE} = 8\text{ V}$; $f = 1\text{ MHz}$)

Collector-base capacitance

($V_{CBO} = 10\text{ V}$; $f = 1\text{ MHz}$)

Noise figure

($I_C = 2\text{ mA}$; $V_{CE} = 6\text{ V}$; $f = 200\text{ MHz}$; $R_g = 75\text{ }\Omega$)

($I_C = 3\text{ mA}$; $V_{CE} = 8\text{ V}$; $f = 500\text{ MHz}$; $R_g = R_{g\text{ opt}}$)

($I_C = 2\text{ mA}$; $V_{CE} = 6\text{ V}$; $f = 800\text{ MHz}$; $R_g = 60\text{ }\Omega$)

($I_C = 10\text{ mA}$; $V_{CE} = 8\text{ V}$; $f = 800\text{ MHz}$; $R_g = 60\text{ }\Omega$)

($I_C = 3\text{ mA}$; $V_{CE} = 10\text{ V}$; $f = 2\text{ GHz}$; $R_g = R_{g\text{ opt}}$)

Power gain

($I_C = 15\text{ mA}$; $V_{CE} = 6\text{ V}$; $f = 800\text{ MHz}$; $R_g = 60\text{ }\Omega$)

($I_C = 25\text{ mA}$; $V_{CE} = 8\text{ V}$; $f = 800\text{ MHz}$; $R_g = 60\text{ }\Omega$)

Output voltage: (three tone modulation f

approx. 800 MHz)

($I_C = 15\text{ mA}$; $V_{CE} = 6\text{ V}$; $d_{IM} = 60\text{ dB}$; $R_L = R_g = 75\text{ }\Omega$) V_O

($I_C = 25\text{ mA}$; $V_{CE} = 8\text{ V}$; $d_{IM} = 60\text{ dB}$; $R_L = R_g = 75\text{ }\Omega$) V_O

h_{fe}	70	—	—
h_{fe}	—	80	—
f_T	5	—	GHz
f_T	—	4.5	GHz
C_{12e}	0.4	—	pF
C_{12e}	—	0.65	pF
C_{CBO}	0.7	—	pF
NF	2	—	dB
$NF_{opt.}$	—	1.9	dB
NF	2	—	dB
NF	—	2.8	dB
$NF_{opt.}$	4	—	dB
G_{pe}	14	—	dB
G_{pe}	—	13	dB
V_O	140	—	mV
V_O	—	350	mV

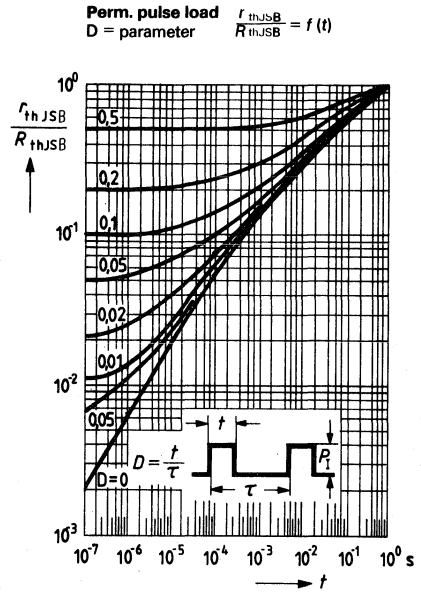
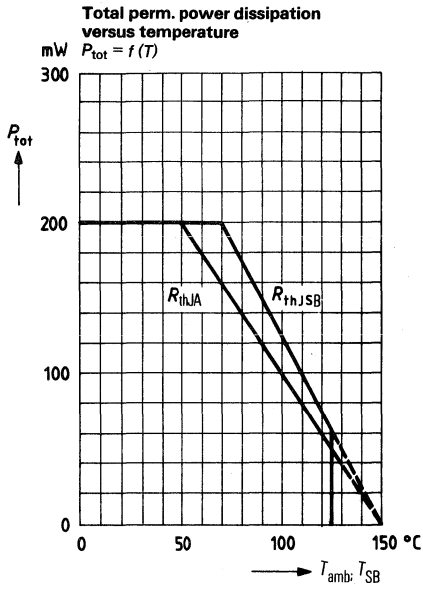

BFR 96 is an epitaxial NPN silicon planar RF transistor in a plastic package similar to TO 119 (50 B 3 DIN 41867), intended for use in broadband and antenna amplifiers of high output power up to the GHz range.

Type	Ordering code
BFR 96	Q62702-F516

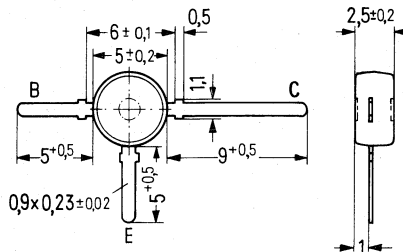

Approx. weight 0.3 g Dimensions in mm

Maximum ratings

Collector-emitter voltage
 Collector-base voltage
 Emitter-base voltage
 Collector current
 Junction temperature
 Storage temperature range
 Total power dissipation ($T_{amb} = 50^{\circ}C$)

V_{CEO}	15	V
V_{CBO}	20	V
V_{EBO}	3	V
I_C	90	mA
T_j	150	$^{\circ}C$
T_{stg}	-55 to +125	$^{\circ}C$
P_{tot}	500	mW

Thermal resistance

Junction to ambient air
 mounted on glass fiber epoxy resin PCB
 40 mm x 25 mm x 1.5 mm

R_{thJA}	≤ 200	K/W
------------	------------	-----

Static characteristics ($T_{\text{amb}} = 25^{\circ}\text{C}$)

Collector-emitter breakdown voltage ($I_{\text{CEO}} = 1 \text{ mA}$)	$V_{(\text{BR})\text{CEO}}$	> 15	V
Collector-base breakdown voltage ($I_{\text{CBO}} = 100 \mu\text{A}$)	$V_{(\text{BR})\text{CBO}}$	> 20	V
Emitter-base breakdown voltage ($I_{\text{EBO}} = 100 \mu\text{A}$)	$V_{(\text{BR})\text{EBO}}$	> 3	V
DC current gain ($I_{\text{C}} = 60 \text{ mA}$; $V_{\text{CE}} = 8 \text{ V}$)	h_{FE}	50 (>25)	–

Dynamic characteristics ($T_{\text{amb}} = 25^{\circ}\text{C}$)

Transition frequency ($V_{\text{CE}} = 8 \text{ V}$; $I_{\text{C}} = 60 \text{ mA}$; $f = 200 \text{ MHz}$)	f_{T}	5	GHz
Collector-base capacitance ($V_{\text{CBO}} = 8 \text{ V}$; $f = 1 \text{ MHz}$)	C_{CBO}	1.3	pF
Reverse transfer capacitance ($I_{\text{C}} = 1 \text{ mA}$; $V_{\text{CE}} = 10 \text{ V}$; $f = 1 \text{ MHz}$)	$C_{12\text{e}}$	0.9	pF
Power gain ($I_{\text{C}} = 60 \text{ mA}$; $V_{\text{CE}} = 8 \text{ V}$; $f = 800 \text{ MHz}$; $R_{\text{g}} = 60 \Omega$)	G_{pe}	9	dB
Noise figure ($I_{\text{C}} = 60 \text{ mA}$; $V_{\text{CE}} = 8 \text{ V}$; $f = 800 \text{ MHz}$; $R_{\text{g}} = 60 \Omega$)	NF	4.5	dB
Output voltage: (three tone modulation f approx. 800 MHz) ($I_{\text{C}} = 60 \text{ mA}$, $V_{\text{CE}} = 8 \text{ V}$; $d_{\text{IM}} = 60 \text{ dB}$; $R_{\text{L}} = R_{\text{g}} = 75 \Omega$)	V_{O}	650	mV

S parameter:

Operating point: $V_{CE} = 8 \text{ V}$, $I_C = 60 \text{ mA}$, $Z_o = 50 \Omega$

f (GHz)	S_{11}	φ	S_{21}	φ	S_{12}	φ	S_{22}	φ
0,1	0,343	-150	23,71	1,04	0,022	68	0,299	-61
0,2	0,354	-169	12,48	0,92	0,042	73	0,140	-68
0,3	0,365	-179	8,35	0,85	0,061	74	0,122	-100
0,4	0,383	177	6,27	0,81	0,079	75	0,164	-85
0,5	0,385	174	4,99	0,75	0,098	74	0,131	-54
0,6	0,392	169	4,20	0,74	0,115	73	0,045	-91
0,7	0,399	165	3,67	0,70	0,135	71	0,130	-108
0,8	0,407	161	3,22	0,68	0,155	70	0,135	-83
0,9	0,437	161	2,38	0,65	0,169	69	0,074	-96
1,0	0,431	160	2,60	0,61	0,185	67	0,113	-118
1,1	0,422	155	2,39	0,58	0,201	66	0,115	-113
1,2	0,441	150	2,20	0,55	0,215	63	0,115	-123
1,3	0,460	146	2,06	0,52	0,234	63	0,124	-126
1,4	0,485	147	1,93	0,50	0,250	61	0,126	-134
1,5	0,475	147	1,30	0,47	0,261	61	0,129	-135
1,6	0,490	143	1,72	0,44	0,277	59	0,125	-144
1,7	0,498	142	1,63	0,43	0,290	58	0,129	-154
1,8	0,523	140	1,52	0,40	0,296	57	0,156	-163
1,9	0,531	141	1,45	0,37	0,303	54	0,164	-159
2,0	0,522	130	1,41	0,34	0,322	52	0,163	-169

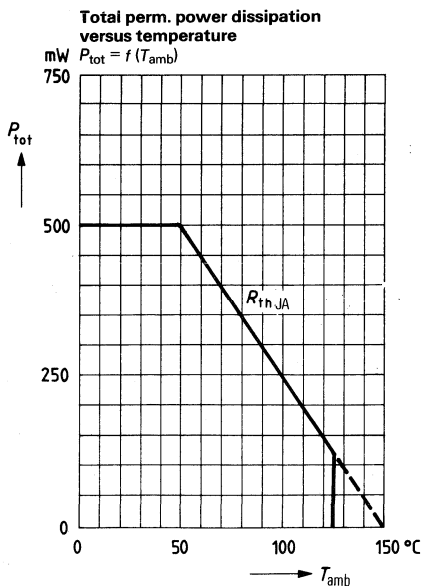

BFS 17 is an epitaxial NPN silicon planar RF transistor in TO 236 plastic package (23 A 3 DIN 41869), intended for use in film circuits up to the GHz range.

The transistor BFS 17 is marked "MA". It also available upon request with changed terminal sequence (emitter and base terminal interchanged) under the designation BFS 17 R (mark "MZ").

Type	Mark	Ordering code
BFS 17	MA	Q62702-F337
BFS 17R	MZ	Q62702-F586

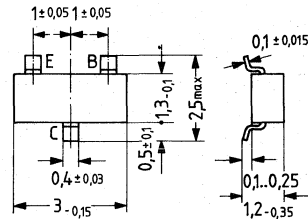

Approx. weight 0.02 g Dimensions in mm

Maximum ratings

Collector-emitter voltage	V_{CEO}	15	V
Collector-base voltage	V_{CB0}	25	V
Emitter-base voltage	V_{EBO}	2.5	V
Collector current	I_C	25	mA
Collector peak current	I_{CM}	50	mA
Storage temperature range	T_{stg}	-55 to +125	°C
Junction temperature	T_j	150	°C
Total power dissipation ($T_{amb} \leq 50^\circ\text{C}$)	P_{tot}	200	mW

Thermal resistance

Junction to ambient air	R_{thJA}	< 500	K/W
Junction to substrate back (ceramic substrate 0.7 mm with 2.5 cm ² area)	R_{thJSB}	< 400	K/W

Static characteristics ($T_{amb} = 25^{\circ}\text{C}$)

Collector cutoff current ($V_{CBO} = 10\text{ V}$) ($V_{CBO} = 10\text{ V}$; $T_j = 100^{\circ}\text{C}$)	I_{CBO}	<50	nA
Collector-emitter breakdown voltage ($I_{CEO} = 10\text{ mA}$)	I_{CBO}	<10	μA
DC current gain ($I_C = 2\text{ mA}$; $V_{CE} = 1\text{ V}$) ($I_C = 25\text{ mA}$; $V_{CE} = 1\text{ V}$)	$V_{(BR)CEO}$	>15	V
	h_{FE}	20 to 150	–
	h_{FE}	≥ 20	–

Dynamic characteristics ($T_{amb} = 25^{\circ}\text{C}$)

Transition frequency ($I_C = 2\text{ mA}$; $V_{CE} = 5\text{ V}$; $f = 200\text{ MHz}$)	f_T	1.3	GHz
Reverse transfer capacitance ($I_C = 2\text{ mA}$; $V_{CE} = 5\text{ V}$; $f = 1\text{ MHz}$)	C_{12e}	0.65	pF
Collector-base capacitance ($V_{CBO} = 10\text{ V}$; $f = 1\text{ MHz}$)	C_{CBO}	1	pF
Noise figure ($I_C = 2\text{ mA}$; $V_{CE} = 5\text{ V}$; $R_g = 60\ \Omega$; $f = 800\text{ MHz}$)	NF_T	4	dB
Power gain ($V_{CE} = 5\text{ V}$; $I_{CE} = 10\text{ mA}$; $f = 800\text{ MHz}$; $R_g = 60\ \Omega$)	G_{pe}	11	dB
($V_{CE} = 5\text{ V}$; $I_{CE} = 10\text{ mA}$; $f = 200\text{ MHz}$; $R_g = 60\ \Omega$)	G_{pe}	23	dB
Output voltage: (three tone modulation f approx. 800 MHz) ($V_{CE} = 5\text{ V}$; $I_C = 14\text{ mA}$, $d_{IM} = 60\text{ dB}$; $R_g = R_L = 75\ \Omega$)	V_O	150	mV

S parameter

Operating point: $V_{CE} = 5 \text{ V}$, $I_C = 14 \text{ mA}$, $Z_o = 50 \Omega$

f (GHz)	S_{11}	φ	S_{21}	φ	S_{12}	φ	S_{22}	φ
0,1	0,451	-77	16,77	125	0,022	63	0,798	-20
0,2	0,335	-113	10,26	105	0,032	60	0,641	-19
0,3	0,290	-139	7,01	93	0,045	65	0,556	-23
0,4	0,272	-148	5,44	85	0,055	65	0,593	-21
0,5	0,261	-166	4,40	60	0,066	66	0,537	-22
0,6	0,267	-167	3,63	74	0,076	67	0,554	-27
0,7	0,242	179	3,19	70	0,088	67	0,579	-23
0,8	0,261	177	2,76	65	0,097	66	0,512	-25
0,9	0,234	168	2,51	61	0,111	66	0,535	-33
1,0	0,283	158	2,26	57	0,122	67	0,576	-31
1,1	0,257	161	2,10	53	0,133	67	0,517	-32
1,2	0,270	145	1,91	49	0,143	66	0,549	-41
1,3	0,287	144	1,77	45	0,156	64	0,571	-40
1,4	0,307	135	1,68	41	0,171	63	0,513	-41
1,5	0,310	136	1,59	38	0,184	63	0,570	-51
1,6	0,315	125	1,48	34	0,192	62	0,574	-46
1,7	0,363	123	1,40	31	0,205	62	0,473	-50
1,8	0,350	124	1,29	26	0,214	59	0,543	-70
1,9	0,353	114	1,28	23	0,238	58	0,645	-60
2,0	0,378	112	1,23	22	0,253	58	0,536	-57

Total perm. power dissipation versus temperature

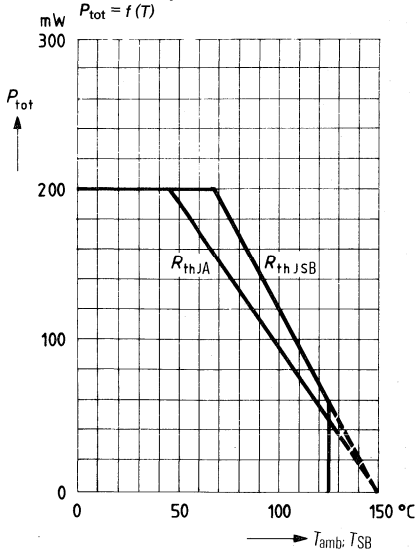

Transition frequency $f_T = f(I_C)$

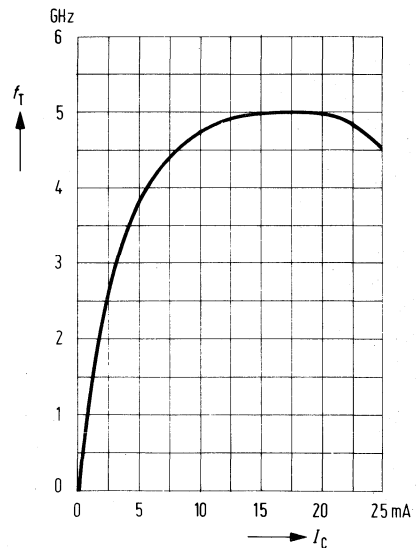

NPN Silicon RF Transistors

BFS 18
BFS 18 R
BFS 19
BFS 19 R

BFS 18 and BFS 19 are epitaxial NPN silicon planar transistors in TO 236 plastic package (23 A 3 DIN 41869). These transistors were especially designed for use in RF circuits in thick and thin film technology. For identification purposes, the transistors are marked as follows: BFS 18 = "CA"; BFS 19 = "CB"; The transistors are also available upon request with changed terminal sequence (emitter and base terminal interchanged) under the designation BFS 18R (mark "CY") and BFS 19R (mark "CZ").

Type	Mark	Ordering code
BFS 18	CA	Q62702-F348
BFS 19	CB	Q62702-F349
BFS 18R	CY	Q62702-F587
BFS 19R	CZ	Q62702-F588

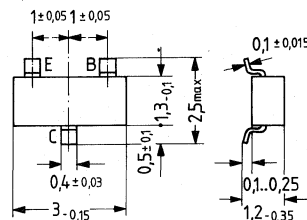

Approx. weight 0.02 g Dimensions in mm

Maximum ratings

Collector-emitter voltage	
Collector-base voltage	
Emitter-base voltage	
Collector current	
Junction temperature	
Storage temperature range	
Total power dissipation ($T_{SB} < 65^{\circ}\text{C}$)	

	BFS 18	BFS 19	
V_{CEO}	20		V
V_{CBO}	30		V
V_{EBO}	5		V
I_C	30		mA
T_j	125		$^{\circ}\text{C}$
T_{stg}	-65 to +125		$^{\circ}\text{C}$
P_{tot}	150		mW

Thermal resistance

Junction to ambient air	
Junction to substrate back ¹⁾	

R_{thJA}	520	K/W
R_{thJSB}	410	K/W

1) Ceramic substrate 0.7 mm; 2.5 cm² area

Static characteristics ($T_{amb} = 25^{\circ}\text{C}$)

Collector-emitter breakdown voltage
 ($I_{CEO} = 2\text{ mA}$)
 Collector cutoff current
 ($V_{CBO} = 20\text{ V}$)
 ($V_{CBO} = 20\text{ V}; T_j = 100^{\circ}\text{C}$)
 Base-emitter voltage
 ($V_{CE} = 10\text{ V}; I_C = 1\text{ mA}$)
 DC current gain ($V_{CE} = 10\text{ V}; I_C = 1\text{ mA}$)

	BFS 18	BFS 19	
$V_{(BR)CEO}$	> 20	> 20	V
I_{CBO}	< 100	< 100	nA
I_{CBO}	< 10	< 10	μA
V_{BE}	650 to 740	650 to 740	mV
h_{FE}	35 to 125	65 to 225	-

Dynamic characteristics ($T_{amb} = 25^{\circ}\text{C}$)

Transition frequency
 ($V_{CE} = 10\text{ V}; I_C = 1\text{ mA}; f = 100\text{ MHz}$)
 Reverse transfer capacitance
 ($V_{CE} = 10\text{ V}; I_C = 1\text{ mA}; f = 1\text{ MHz}$)
 Collector-base capacitance
 ($V_{CB} = 10\text{ V}; f = 1\text{ MHz}$)
 Noise figure
 ($V_{CE} = 10\text{ V}; I_C = 1\text{ mA};$
 $R_g = 100\ \Omega; f = 100\text{ MHz}$)

f_T	200	260	MHz
C_{12e}	0.85	0.85	pF
C_{CBO}	1	1	pF
NF	4	4	dB

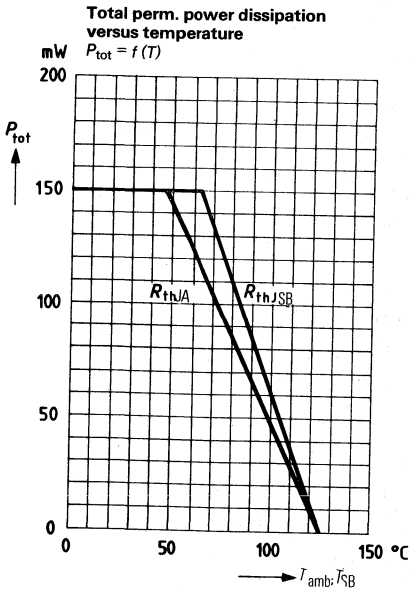

NPN Silicon RF Transistor

BFS 20
BFS 20 R

BFS 20 is an epitaxial NPN silicon planar RF transistor in TO 236 plastic package (23 A 3 DIN 41 869), intended for use in film circuits.

The transistor BFS 20 is marked "NA". It is also available upon request with changed terminal sequence (emitter and base terminal interchanged) under the designation BFS 20R (mark "NZ").

Type	Mark	Ordering code
BFS 20	NA	Q62702-F350
BFS 20 R	NZ	Q62702-F589

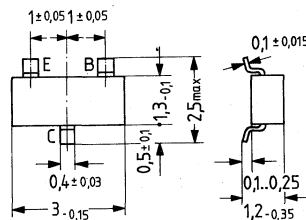

Approx. weight 0.02 g Dimensions in mm

Maximum ratings

Collector-emitter voltage	V_{CE0}	20	V
Collector-base voltage	V_{CB0}	30	V
Emitter-base voltage	V_{EBO}	4	V
Collector current	I_C	25	mA
Junction temperature	T_j	125	°C
Storage temperature range	T_{stg}	-65 to +125	°C
Total power dissipation ($T_{SB} < 65$ °C)	P_{tot}	150	mW

Thermal resistance

Junction to ambient air	R_{thJA}	520	K/W
Junction to substrate back ¹⁾	R_{thJSB}	410	K/W

1.) Ceramic substrate 0.7 mm; 2.5 cm² area

Static characteristics ($T_{amb} = 25^{\circ}\text{C}$)

Collector-emitter breakdown voltage

($I_{CEO} = 2\text{ mA}$)

Collector cutoff current

($V_{CBO} = 20\text{ V}$; $T_j = 100^{\circ}\text{C}$)

Base-emitter voltage

($V_{CE} = 10\text{ V}$; $I_C = 7\text{ mA}$)

DC current gain ($V_{CE} = 10\text{ V}$; $I_C = 7\text{ mA}$)

$V_{(BR)CEO}$	≥ 20	V
I_{CBO}	< 100	nA
I_{CBO}	< 10	μA
V_{BE}	$740 (\leq 900)$	mV
h_{FE}	$85 (> 40)$	-

Dynamic characteristics ($T_{amb} = 25^{\circ}\text{C}$)

Transition frequency

($V_{CE} = 10\text{ V}$; $I_C = 5\text{ mA}$; $f = 100\text{ MHz}$)

Reverse transfer capacitance

($V_{CE} = 10\text{ V}$; $I_C = 1\text{ mA}$; $f = 1\text{ MHz}$)

Collector-base capacitance

($V_{CB} = 10\text{ V}$; $f = 1\text{ MHz}$)

f_T	$450 (> 275)$	MHz
C_{12e}	0.35	pF
C_{CBO}	0.8	pF

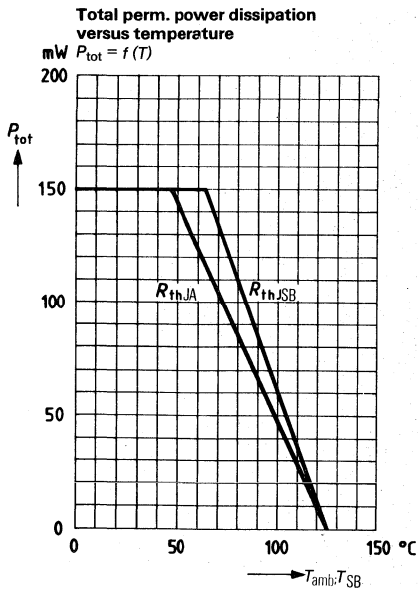

BFS 55 A is an NPN silicon planar RF transistor in TO 72 case (18 A 4 DIN 41 876). The terminals are electrically insulated from the case. The transistor is especially designed for RF applications up to the GHz range, e. g. in antenna amplifiers and radar IF amplifiers as well as for satellite engineering.

Type	Ordering code
BFS 55 A	Q62702-F454

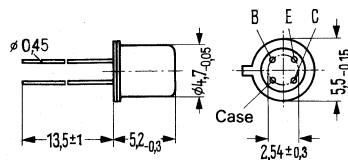

Approx. weight 0.3 g Dimensions in mm

Maximum ratings

Collector-emitter voltage
 Collector-emitter voltage
 ($R_{BE} \leq 50 \Omega$)
 Emitter-base voltage
 Collector current
 Base current
 Junction temperature
 Storage temperature range
 Total power dissipation ($T_{amb} \leq 25^\circ\text{C}$)

V_{CEO}	15	V
V_{CER}	20	V
V_{EBO}	2.5	V
I_C	50	mA
I_B	10	mA
T_j	200	$^\circ\text{C}$
T_{stg}	-65 to +175	$^\circ\text{C}$
P_{tot}	250	mW

Thermal resistance

Junction to ambient air
 Junction to case

R_{thJA}	≤ 700	K/W
R_{thJC}	≤ 400	K/W

Static characteristics ($T_{amb} = 25^{\circ}\text{C}$)

Collector-emitter breakdown voltage ($I_C = 0.5 \text{ mA}; I_B = 0$)	$V_{(BR)CEO}$	> 15	V
Collector-emitter breakdown voltage ($I_C = 10 \text{ mA}; R_{BE} = 50 \Omega$)	$V_{(BR)CER}$	> 20	V
Collector-base breakdown voltage ($I_C = 100 \mu\text{A}; V_{BE} = 0$)	$V_{(BR)CBS}$	> 20	V
Emitter-base breakdown voltage ($I_E = 0.1 \text{ mA}; I_C = 0$)	$V_{(BR)EBO}$	> 2.5	V
Collector cutoff current ($V_{CBO} = 10 \text{ V}$)	I_{CBO}	< 50	nA
DC current gain ($I_C = 25 \text{ mA}; V_{CE} = 8 \text{ V}$)	h_{FE}	> 30	–
DC current gain ($I_C = 50 \text{ mA}; V_{CE} = 5 \text{ V}$)	h_{FE}	> 30	–

Dynamic characteristics ($T_{amb} = 25^{\circ}\text{C}$)

Small-signal current gain ($I_C = 25 \text{ mA}; V_{CE} = 8 \text{ V}; f = 1 \text{ kHz}$)	h_{fe}	80	–
Transition frequency ($f = 200 \text{ MHz}; I_C = 25 \text{ mA}; V_{CE} = 8 \text{ V}$)	f_T	4.5	GHz
Reverse transfer capacitance ($f = 1 \text{ MHz}; I_C = 1 \text{ mA}; V_{CE} = 8 \text{ V}$)	C_{12e}	0.65	pF
Output capacitance ($f = 1 \text{ MHz}; V_{CBO} = 8 \text{ V}$)	C_{CBO}	0.85	pF
Noise figure ($I_C = 10 \text{ mA}; V_{CE} = 8 \text{ V}; f = 800 \text{ MHz}; R_g = 60 \Omega$)	NF	2.9	dB
Power gain ($I_C = 25 \text{ mA}; V_{CE} = 8 \text{ V}; f = 800 \text{ MHz}; R_g = 60 \Omega$)	G_{pe}	10	dB
Output voltage: (three tone modulation f approx. 800 MHz) ($I_C = 25 \text{ mA}; V_{CE} = 8 \text{ V}; R_g = R_L = 75 \Omega; d_{IM} = 60 \text{ dB}$)	V_0	350	mV

S parameterOperating point: $V_{CE} = 8 \text{ V}$, $I_C = 25 \text{ mA}$, $Z_o = 50 \Omega$

f (GHz)	S_{11}	φ	S_{21}	φ	S_{12}	φ	S_{22}	φ	G_{\max} (dB)
0,1	0,322	- 47	18,51	119	0,025	75	0,658	-18	28,29
0,2	0,175	- 57	10,74	107	0,045	77	0,552	-16	22,34
0,3	0,099	- 69	7,47	100	0,066	81	0,491	-14	18,71
0,4	0,053	- 89	5,69	96	0,084	83	0,439	-15	16,05
0,5	0,041	-139	4,61	93	0,103	84	0,445	-19	14,24
0,6	0,061	-161	3,92	91	0,125	84	0,453	-18	12,28
0,7	0,062	-164	3,32	89	0,140	85	0,441	-17	11,38
0,8	0,051	-169	2,95	87	0,159	85	0,418	-17	10,24
0,9	0,033	-179	2,55	85	0,174	85	0,430	-24	9,04
1,0	0,009	114	2,32	82	0,192	83	0,472	-25	8,42
1,1	0,041	19	2,09	79	0,207	82	0,528	-25	7,85
1,2	0,104	12	1,87	78	0,218	81	0,520	-26	6,84
1,3	0,182	14	1,67	74	0,224	78	0,577	-29	6,36
1,4	0,255	15	1,48	70	0,233	73	0,621	-32	5,84
1,5	0,335	15	1,33	68	0,244	71	0,662	-32	5,53

Total perm. power dissipation versus temperature

$P_{tot} = f(T); R_{th} = \text{parameter}$

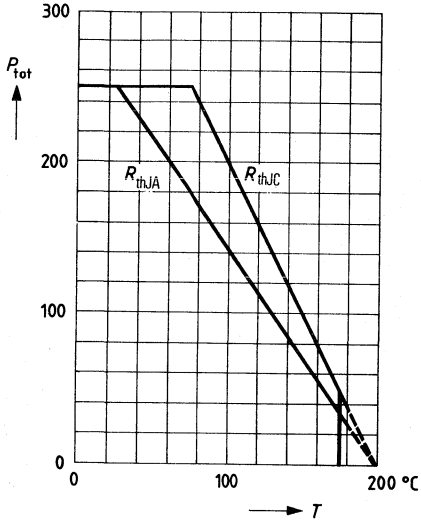

Transition frequency $f_T = f(I_C)$
 $V_{CE} = 8 \text{ V}; f = 200 \text{ MHz}$

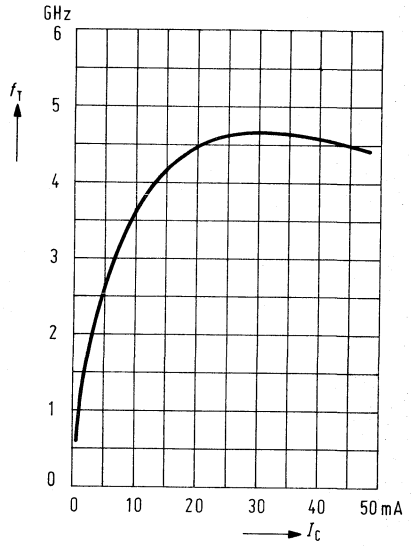

Noise figure $NF = f(I_C)$

$V_{CE} = 8 \text{ V}; f = 800 \text{ MHz};$

$R_g = 60 \Omega$

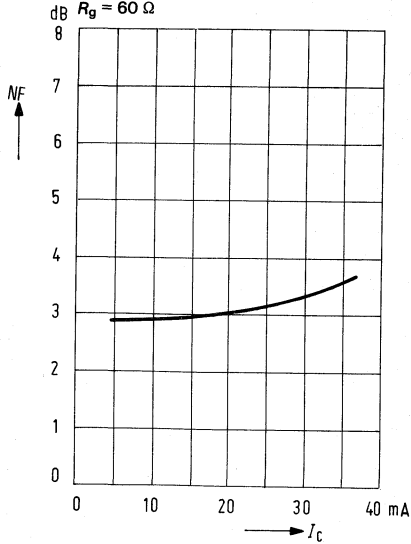

BFT 12 is an epitaxial NPN silicon planar RF transistor in a plastic package similar to TO 119 (50 B 3 DIN 41 867), intended for universal application in amplifiers up to the GHz range, e. g. for broadband antenna amplifiers with a high output power and linearity and for oscillators.

Type	Ordering code
BFT 12	Q62702-F390

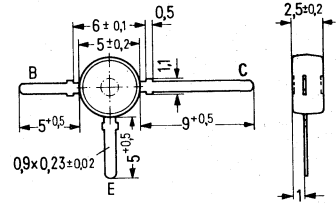

Approx. weight 0.3 g Dimensions in mm

Maximum ratings

Collector-base-voltage	V_{CBO}	25	V
Collector-emitter voltage	V_{CEO}	15	V
Emitter-base voltage	V_{EBO}	3.5	V
Collector current	I_C	150	mA
Collector peak current ($f > 1$ MHz)	I_{CM}	300	mA
Base current	I_B	50	mA
Junction temperature	T_j	150	°C
Storage temperature range	T_{stg}	-55 to +125	°C
Total power dissipation ($T_{amb} = 66^\circ\text{C}$)	P_{tot}	700	mW

Thermal resistance

Junction to ambient air ¹⁾	R_{thJA}	≤ 120	K/W
Junction to case	R_{thJC}	≤ 90	K/W

1) when mounted on glass fiber epoxy resin PCB 40 mm x 25 mm x 1 mm

Static characteristics ($T_{amb} = 25^{\circ}\text{C}$)

Collector-base breakdown voltage

$V_{(BR)CBO}$	> 25	V
---------------	------	---

($I_{CBO} = 100 \mu\text{A}$)

DC current gain

($I_C = 50 \text{ mA}; V_{CE} = 5 \text{ V}$)

h_{FE}	≥ 25	-
----------	-----------	---

Dynamic characteristics ($T_{amb} = 25^{\circ}\text{C}$)

Transition frequency

($I_C = 80 \text{ mA}; V_{CE} = 5 \text{ V}; f = 200 \text{ MHz}$)

f_T	1.9	GHz
-------	-----	-----

Reverse transfer capacitance

($I_C = 5 \text{ mA}; V_{CE} = 10 \text{ V}; f = 1 \text{ MHz}$)

C_{12e}	2.4	pF
-----------	-----	----

Collector-base capacitance

($V_{CBO} = 10 \text{ V}; f = 1 \text{ MHz}$)

C_{CBO}	3	pF
-----------	---	----

Power gain

($I_C = 40 \text{ mA}; V_{CE} = 7.5 \text{ V}; f = 800 \text{ MHz};$

$R_g = 60 \Omega$)

G_{pe}	7.5	dB
----------	-----	----

($I_C = 80 \text{ mA}; V_{CE} = 7.5 \text{ V}; f = 800 \text{ MHz};$

$R_g = 60 \Omega$)

G_{pe}	8	dB
----------	---	----

Noise figure

($R_g = 60 \Omega; I_C = 40 \text{ mA}; V_{CE} = 7.5 \text{ V};$

$f = 800 \text{ MHz}$)

NF	6.5	dB
----	-----	----

Output voltage¹⁾

($I_C = 80 \text{ mA}; V_{CE} = 7.5 \text{ V}; f = 800 \text{ MHz};$

$d_{IM} = 60 \text{ dB}, R_g = R_L = 75 \Omega$)

V_0	1000	mV
-------	------	----

S parameter at $V_{CE} = 7.5 \text{ V}; I_C = 60 \text{ mA}; Z_0 = 50 \Omega$

f (GHz)	S_{11e}	φ	S_{21e}	φ	S_{12e}	φ	S_{22e}	φ
0,1	0,691	-170	14,199	94	0,022	55	0,208	-115
0,2	0,701	-177	7,261	85	0,038	68	0,160	-135
0,3	0,717	177	4,860	78	0,053	70	0,151	-147
0,4	0,722	175	3,666	73	0,069	71	0,159	-148
0,5	0,715	173	2,909	67	0,083	72	0,168	-149
0,6	0,726	169	2,458	63	0,101	73	0,179	-148
0,7	0,738	167	2,102	59	0,115	72	0,192	-149
0,8	0,736	165	1,823	53	0,130	72	0,214	-149
0,9	0,740	163	1,619	49	0,146	71	0,240	-147
1	0,752	161	1,458	44	0,159	70	0,244	-148

1) three tone modulation f approx. 800 MHz

Circuit example: Broadband RF amplifier

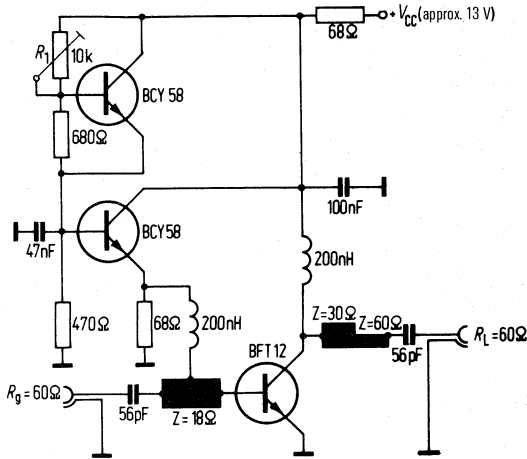

Operating point (set with R_1):
 $I_C = 80 \text{ mA}$; $V_{CE} = 7.5 \text{ V}$.

At $f = 800 \text{ MHz}$ and an intermodulation product distance of $d_{IM} = 60 \text{ dB}^1$, the following values are obtained:

Output voltage $V_O = 700 \text{ mV}$
 Power gain $G_P = 8 \text{ dB}$
 (refer to curve $G_P = f(f)$)

1) Two-tone modulation $f_1 = 800 \text{ MHz}$; $f_2 = 804 \text{ MHz}$.

Oscillator diagram

$f = 1 \text{ GHz}$; $L = 15 \text{ mm strip-line}$
 $Z_O = 50 \Omega$

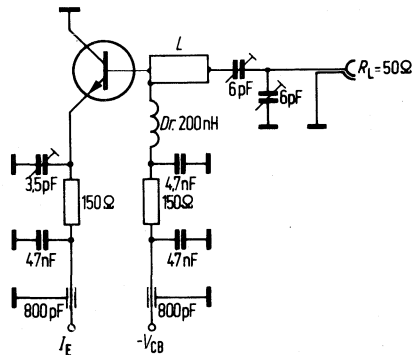

Total perm. power dissipation versus temperature
 $P_{tot} = f(T_{amb})$

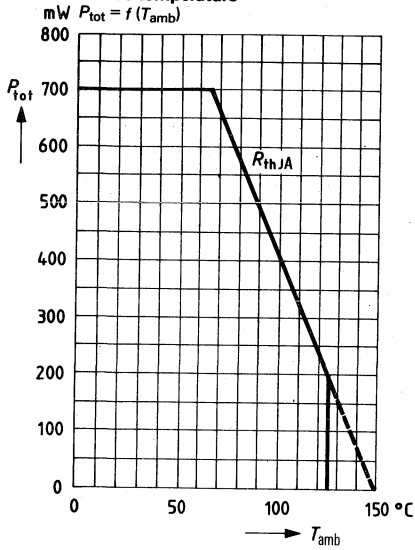

Transition frequency $f_T = f(I_C)$
 $V_{CE} = 5\text{ V}; f = 200\text{ MHz}$

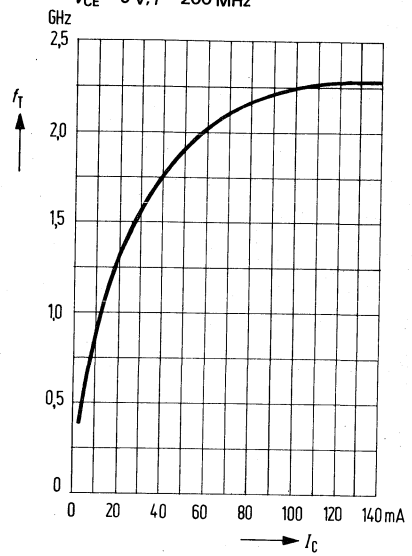

Power gain $G_p = f(f)$
 $I_C = 80\text{ mA}; V_{CE} = 7.5\text{ V}$
 TV band IV-V (refer to circuit example)

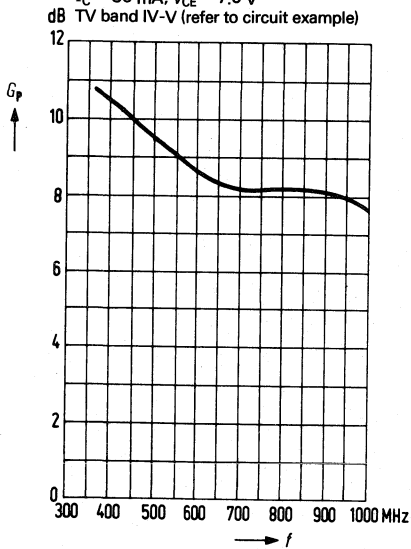

Oscillator output power
 $P_{osc} = f(V_{CB}); I_C = 75\text{ mA}; f = 1\text{ GHz}$

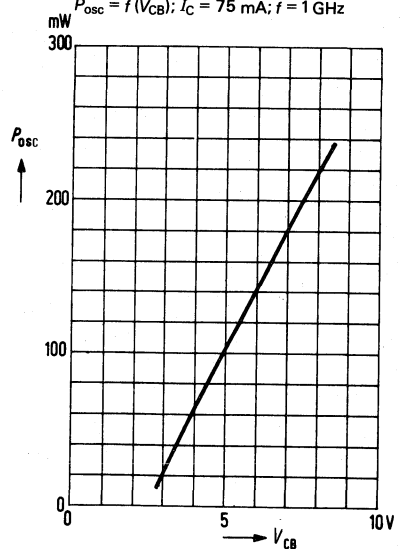

BFT 65 is an epitaxial NPN silicon planar RF transistor in a plastic package similar to TO 119 (50₃B 3 DIN 41867) intended for use in RF amplifiers up to the GHz range, e.g. in low-noise input stages and driver stages of antenna amplifiers.

Type	Ordering code
BFT 65	Q62702-F451

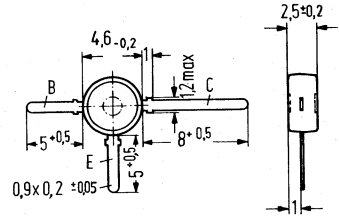

Approx. weight 0.3 g Dimensions in mm

Maximum ratings

Collector-emitter voltage
 Collector-emitter voltage ($R_{BE} \leq 50 \Omega$)
 Emitter-base voltage
 Collector current
 Base current
 Junction temperature
 Storage temperature range
 Total power dissipation ($T_{amb} \leq 50^\circ\text{C}$)

V_{CE0}	15	V
V_{CER}	20	V
V_{EBO}	2.5	V
I_C	50	mA
I_B	10	mA
T_j	150	$^\circ\text{C}$
T_{stg}	-55 to +125	$^\circ\text{C}$
P_{tot}	250	mW

Thermal resistance

Junction to ambient air
 mounted on glass fiber epoxy resin PCB
 40 x 25 x 1.5 mm

R_{thJA}	≤ 700	K/W
R_{thJA}	≤ 400	K/W

Static characteristics ($T_{amb} = 25^\circ\text{C}$)

Collector-emitter breakdown voltage
 ($I_C = 0.5 \text{ mA}$; $I_B = 0$)
 Collector-emitter breakdown voltage
 ($I_C = 10 \text{ mA}$; $R_{BE} = 50 \Omega$)
 Emitter-base breakdown voltage
 ($I_E = 0.1 \text{ mA}$; $I_C = 0$)
 Collector cutoff current
 ($V_C = 10 \text{ V}$; $I_E = 0$)
 DC current gain ($I_C = 25 \text{ mA}$; $V_{CE} = 8 \text{ V}$)
 DC current gain ($I_C = 50 \text{ mA}$; $V_{CE} = 5 \text{ V}$)

$V_{(BR)CEO}$	> 15	V
$V_{(BR)CER}$	> 20	V
$V_{(BR)EBO}$	> 2.5	V
I_{CBO}	< 50	nA
h_{FE}	> 30	-
h_{FE}	> 30	-

Dynamic characteristics ($T_{amb} = 25\text{ }^\circ\text{C}$)

Small signal current gain

($I_C = 25\text{ mA}$; $V_{CE} = 8\text{ V}$; $f = 1\text{ kHz}$)

h_{fe} | 80 | -

Transition frequency ($f = 200\text{ MHz}$,

$I_C = 25\text{ mA}$; $V_{CE} = 8\text{ V}$)

f_T | 5 | GHz

Reverse transfer capacitance ($f = 1\text{ MHz}$,

$I_C = 1\text{ mA}$; $V_{CE} = 8\text{ V}$)

C_{12e} | 0.65 | pF

Output capacitance ($f = 1\text{ MHz}$,

$V_{CBO} = 8\text{ V}$)

C_{CBO} | 0.85 | pF

Noise figure

($I_C = 10\text{ mA}$; $V_{CE} = 8\text{ V}$; $f = 800\text{ MHz}$)

($R_g = 60\text{ }\Omega$)

NF | 2.8 | dB

Power gain

($I_C = 25\text{ mA}$; $V_{CE} = 8\text{ V}$; $f = 800\text{ MHz}$,

$R_g = 60\text{ }\Omega$)

G_{pe} | 12 | dB

Output voltage¹⁾

($I_C = 25\text{ mA}$; $V_{CE} = 8\text{ V}$;

$R_g = R_L = 75\text{ }\Omega$; $d_{IM} = 60\text{ dB}$)

V_O | 350 | mV

S parameter ($I_C = 25\text{ mA}$; $V_{CE} = 8\text{ V}$; $Z_o = 50\text{ }\Omega$)

f (GHz)	S_{11e}	φ	S_{21e}	φ	S_{12e}	φ	S_{22e}	φ
0,1	0,347	-101	25,813	122	0,017	64	0,668	-27
0,2	0,330	-140	15,191	103	0,027	64	0,453	-25
0,3	0,323	-159	10,430	98	0,038	68	0,361	-31
0,4	0,341	-169	7,915	89	0,047	72	0,411	-35
0,5	0,343	-174	6,311	85	0,058	72	0,441	-23
0,6	0,347	179	5,236	80	0,068	71	0,340	-19
0,7	0,347	174	4,604	76	0,081	72	0,346	-35
0,8	0,351	168	3,994	74	0,093	71	0,403	-34
0,9	0,392	169	3,629	71	0,099	73	0,362	-28
1,0	0,386	168	3,254	67	0,109	72	0,340	-36
1,1	0,377	161	2,969	64	0,118	71	0,355	-37
1,2	0,410	157	2,125	61	0,127	70	0,332	-41
1,3	0,415	156	2,538	59	0,133	70	0,346	-43
1,4	0,438	152	2,383	57	0,151	70	0,327	-46
1,5	0,439	153	2,212	54	0,157	69	0,345	-49
1,6	0,458	150	2,083	51	0,163	69	0,326	-48
1,7	0,461	149	1,963	49	0,175	68	0,312	-51
1,8	0,492	146	1,832	47	0,162	68	0,284	-57
1,9	0,502	147	1,749	44	0,191	66	0,317	-64
2,0	0,503	146	1,683	41	0,202	65	0,295	-61

1) Three tone modulation f approx. 800 MHz

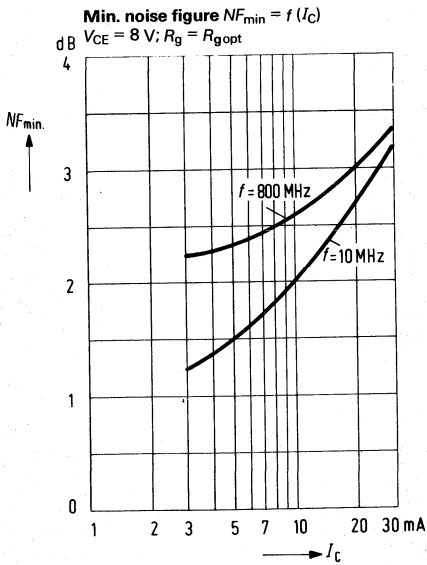
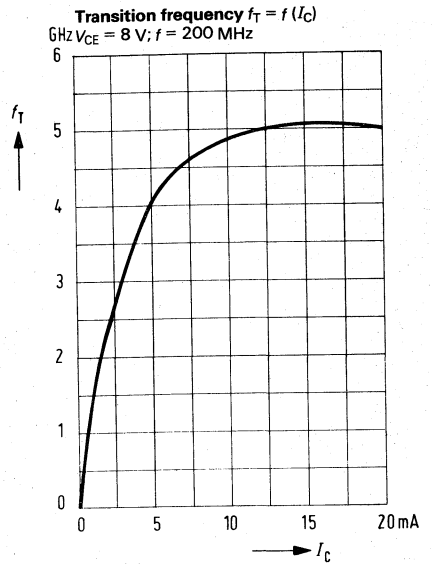
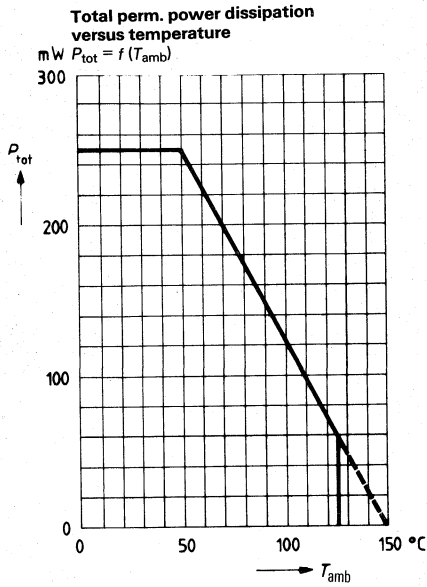

Extremely Low Noise NPN Silicon Broadband Transistors

BFT 66
BFT 67

BFT 66 and BFT 67 are epitaxial NPN silicon planar RF transistors in TO 72 case (18 A 4 DIN 41876), intended for input stage applications in extremely low-noise broadband amplifiers up to 1 GHz.

The terminals are electrically insulated from the case.

Type	Ordering code
BFT 66	Q62702-F456
BFT 67	Q62702-F457

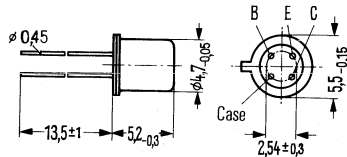

Approx. weight 0.4 g Dimensions in mm

Maximum ratings

Collector-emitter voltage
Collector-base voltage
Emitter-base voltage
Collector current
Base current
Junction temperature
Storage temperature range
Total power dissipation ($T_{amb} \leq 60^\circ\text{C}$)

	BFT 66	BFT 67
V_{CEO}	15	V
V_{CBO}	20	V
V_{EBO}	2.5	V
I_C	30	mA
I_B	4	mA
T_j	200	$^\circ\text{C}$
T_{stg}	-65 to +175	$^\circ\text{C}$
P_{tot}	200	mW

Thermal resistance

Junction to ambient air
Junction to case

R_{thJA}	≤ 700	K/W
R_{thJC}	≤ 400	K/W

Static characteristics ($T_{amb} = 25^{\circ}\text{C}$)

Collector-emitter breakdown voltage
($I_{CEO} = 500 \mu\text{A}$)
Collector-emitter breakdown voltage
($I_{CBO} = 100 \mu\text{A}$)
Emitter-base breakdown voltage
($I_{EBO} = 100 \mu\text{A}$)
Collector cutoff current
($V_{CBO} = 10 \text{V}$)
DC current gain
($I_C = 10 \text{mA}$; $V_{CE} = 6 \text{V}$)

	BFT 66	BFT 67	
$V_{(BR)CEO}$	> 15	> 15	V
$V_{(BR)CES}$	> 20	> 20	V
$V_{(BR)EBO}$	> 2.5	> 2.5	V
I_{CBO}	< 50	< 50	nA
h_{FE}	≥ 30	≥ 30	-

Dynamic characteristics ($T_{amb} = 25^{\circ}\text{C}$)

Small signal current gain
($I_C = 10 \text{mA}$; $V_{CE} = 6 \text{V}$; $f = 1 \text{kHz}$)
Transition frequency
($I_C = 20 \text{mA}$; $V_{CE} = 6 \text{V}$; $f = 200 \text{MHz}$)
Reverse transfer capacitance
($I_C = 1 \text{mA}$; $V_{CE} = 6 \text{V}$; $f = 1 \text{MHz}$)
Noise figure
($I_C = 3 \text{mA}$; $V_{CE} = 6 \text{V}$; $f = 10 \text{MHz}$; $R_g = 75 \Omega$)
($I_C = 3 \text{mA}$; $V_{CE} = 6 \text{V}$; $f = 800 \text{MHz}$; $R_g = 60 \Omega$)
Output voltage¹⁾
($I_C = 20 \text{mA}$; $V_{CE} = 6 \text{V}$; $R_g = R_L = 75 \Omega$;
 $d_{IM} = 60 \text{dB}$)

h_{fe}	70 (>30)	70 (>30)	-
f_T	3.8(>3.6)	3.8(>3.6)	GHz
C_{12e}	0.65	0.65	pF
NF	≤ 1	≤ 1.5	dB
NF	2.1	2.5	dB
V_0	240	240	mV

S parameter

Operating point: $V_{CE} = 5 \text{V}$, $I_C = 3 \text{mA}$, $Z_o = 50 \Omega$

f (GHz)	S_{11}	φ	S_{21}	φ	S_{12}	φ	S_{22}	φ	G_{max} (dB)
0,1	0,62	- 38	18,0	134	0,03	68	0,90	-15	27,32
0,2	0,62	- 49	16,4	133	0,06	77	0,80	-11	22,94
0,4	0,35	- 87	12,3	102	0,09	70	0,68	-14	15,56
0,6	0,24	-138	9,1	86	0,11	68	0,61	-18	11,38
0,8	0,18	-162	7,2	70	0,13	65	0,60	-27	9,28
1,0	0,05	141	5,5	52	0,18	57	0,65	-35	7,30

AV11

1) Three tone modulation f approx. 800 MHz

Circuit examples

Low-noise preamplifier for the frequency band 1 to 300 MHz

Circuit 1

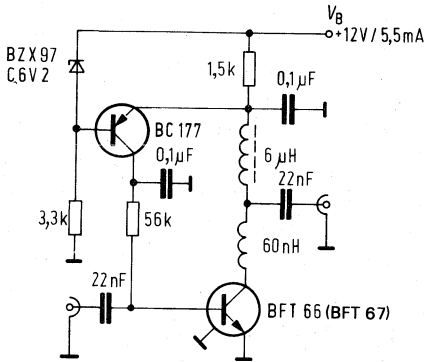

Two-stage broadband amplifier for the frequency band 25 to 1000 MHz

Circuit 2

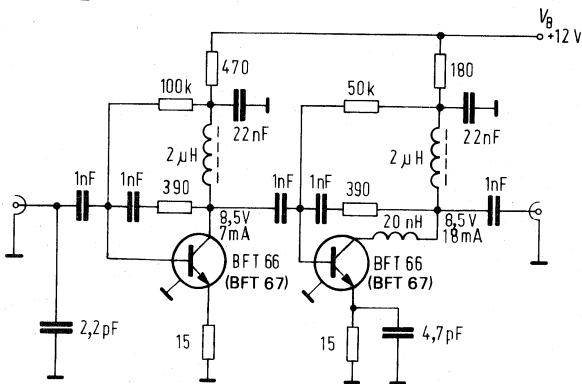

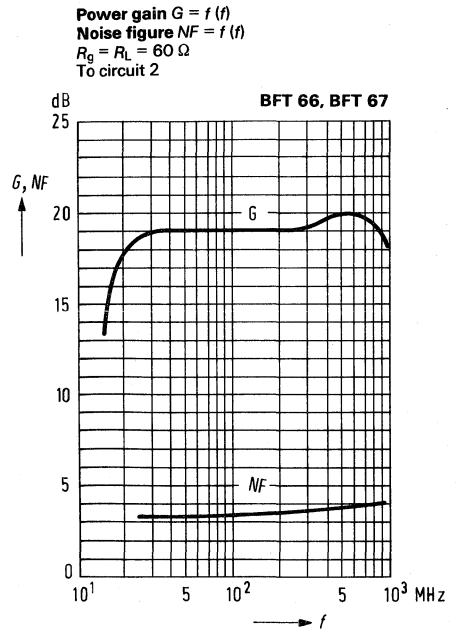
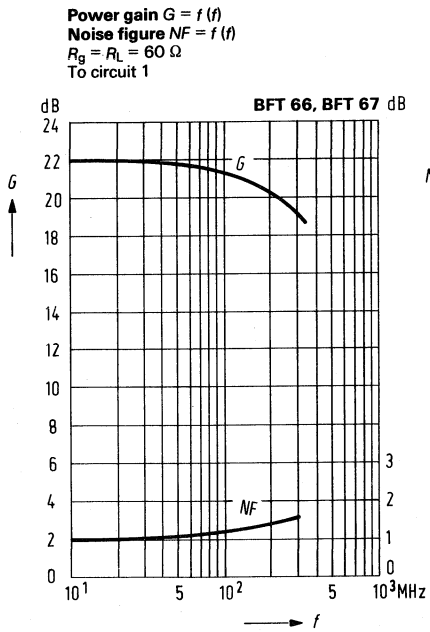
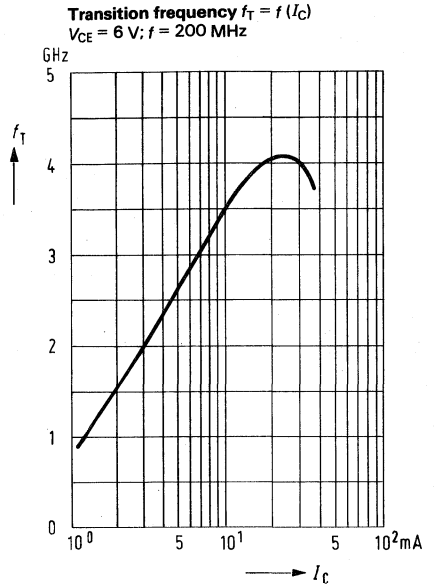
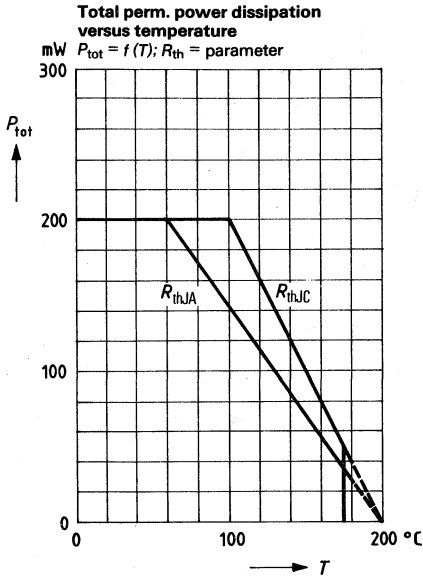

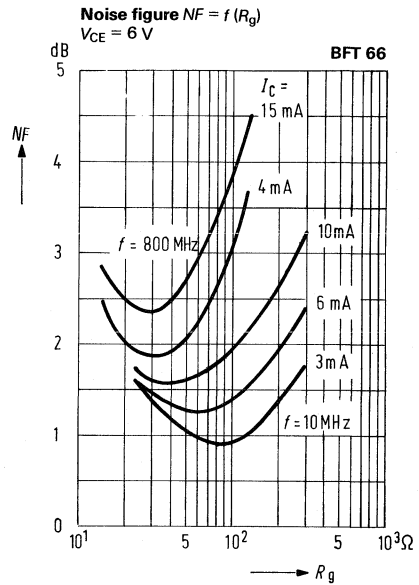
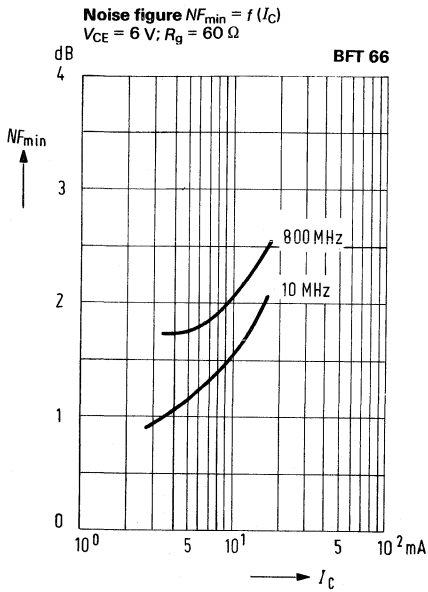

BFT 75 is an epitaxial NPN silicon planar transistor in TO 236 plastic package (23 A 3 DIN 41869), intended for use in low-noise input and intermediate stages in RF amplifiers up to the GHz range, especially for high Q antenna and broadband amplifiers in film circuits. The transistor is marked "KA".

Type	Mark	Ordering code
BFT 75	KA	Q62702-F513

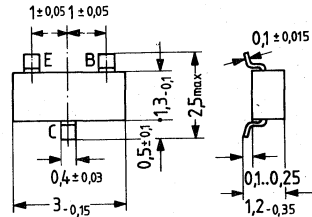

Approx. weight 0.02 g Dimensions in mm

Maximum ratings

- Collector-emitter voltage
- Collector-emitter voltage ($R_{BE} \leq 50 \Omega$)
- Collector-base voltage
- Base-emitter voltage
- Collector current
- Base current
- Storage temperature range
- Junction temperature
- Total power dissipation ($T_{amb} \leq 25^\circ\text{C}$)

V_{CEO}	15	V
V_{CER}	20	V
V_{CBO}	20	V
V_{EBO}	2.5	V
I_C	50	mA
I_B	10	mA
T_{stg}	-55 to +125	$^\circ\text{C}$
T_j	150	$^\circ\text{C}$
P_{tot}	250	mW

Thermal resistance

- Junction to ambient air
- Junction to substrate back¹⁾

R_{thJA}	≤ 500	K/W
R_{thJSB}	≤ 400	K/W

1) Ceramic substrate 0.7 mm; 2.5 cm² area

Static characteristics ($T_{amb} = 25^{\circ}\text{C}$)

Collector cutoff current ($V_{CB} = 10\text{ V}$) ($V_{CB} = 10\text{ V}; T_{amb} = 60^{\circ}\text{C}$)	I_{CBO}	≤ 50	nA
Collector cutoff current ($V_{CE} = 20\text{ V}; V_{BE} = 0$)	I_{CBO}	≤ 0.5	μA
Emitter cutoff current ($V_{EB} = 2\text{ V}$)	I_{CES}	≤ 100	μA
DC current gain	I_{EBO}	≤ 10	μA
($I_C = 25\text{ mA}; V_{CE} = 8\text{ V}$)	h_{FE}	≥ 30	-
($I_C = 50\text{ mA}; V_{CE} = 5\text{ V}$)	h_{FE}	≥ 30	-

Dynamic characteristics ($T_{amb} = 25^{\circ}\text{C}$)

Small signal current gain ($I_C = 25\text{ mA}; V_{CE} = 8\text{ V}; f = 1\text{ kHz}$)	h_{fe}	80	-
Transition frequency ($I_C = 25\text{ mA}; V_{CE} = 8\text{ V}; f = 200\text{ MHz}$)	f_T	5	GHz
($I_C = 50\text{ mA}; V_{CE} = 5\text{ V}; f = 200\text{ MHz}$)	f_T	4.5	GHz
Output capacitance ($V_{CB} = 8\text{ V}; I_E = 0$)	C_{ob}	0.8	pF
Input capacitance ($V_{EB} = 0.5\text{ V}; I_E = 0$)	C_{ib}	2.1	pF
Reverse transfer capacitance ($I_C = 1\text{ mA}; V_{CE} = 8\text{ V}$)	C_{12e}	0.65	pF
Noise figure ($I_C = 10\text{ mA}; V_{CE} = 8\text{ V}; f = 800\text{ MHz}; R_g = 60\ \Omega$)	NF	2.8	dB
($I_C = 3\text{ mA}; V_{CE} = 8\text{ V}; f = 500\text{ MHz}; R_{gopt}$)	NF_{opt}	1.9	dB
Power gain ($I_C = 25\text{ mA}; V_{CE} = 8\text{ V}; f = 800\text{ MHz}; R_g = 60\ \Omega$)	G_{pe}	12	dB
Output voltage ¹⁾ ($I_C = 25\text{ mA}; V_{CE} = 8\text{ V}; d_{IM} = 60\text{ dB}; R_L = R_g = 75\ \Omega$)	V_0	350	mV

1) Three tone modulation f approx. 800 MHz

S parameter:

Operating point: $V_{CE} = 5 \text{ V}$; $I_C = 30 \text{ mA}$, $Z_o = 50 \Omega$

f (GHz)	S_{11e}	φ	S_{21e}	φ	S_{12e}	φ	S_{22e}	φ
0,1	0,316	-110	25,317	115	0,021	68	0,575	-38
0,2	0,260	-141	14,120	99	0,036	69	0,386	-32
0,3	0,262	-164	9,469	90	0,051	71	0,305	-37
0,4	0,246	-166	7,250	84	0,067	70	0,332	-31
0,5	0,241	176	5,848	80	0,082	70	0,278	-31
0,6	0,251	178	4,855	76	0,096	69	0,304	-37
0,7	0,227	167	4,253	72	0,112	68	0,314	-27
0,8	0,246	166	3,673	67	0,126	66	0,247	-31
0,9	0,217	159	3,346	64	0,143	64	0,278	-44
1,0	0,266	150	3,008	61	0,156	63	0,322	-37
1,1	0,241	155	2,782	57	0,171	62	0,254	-35
1,2	0,249	139	2,540	54	0,185	60	0,281	-49
1,3	0,262	139	2,365	50	0,199	57	0,291	-46
1,4	0,282	131	2,221	47	0,215	55	0,246	-50
1,5	0,277	134	2,120	44	0,229	54	0,312	-62
1,6	0,283	122	1,992	40	0,238	52	0,308	-49
1,7	0,327	121	1,863	38	0,251	51	0,181	-54
1,8	0,311	122	1,737	33	0,259	48	0,286	-92
1,9	0,312	114	1,719	30	0,281	45	0,361	-68
2,0	0,330	112	1,662	29	0,295	44	0,251	-56

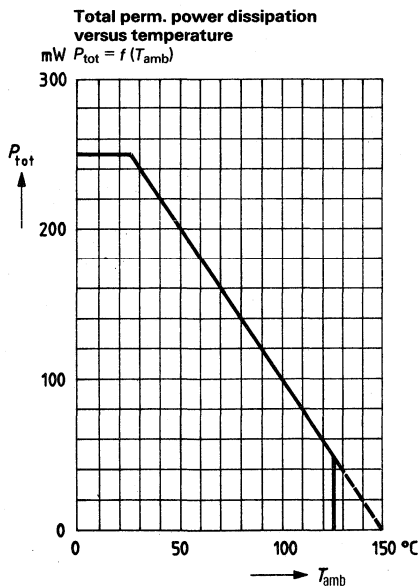

Extremely Low Noise NPN Silicon RF Broadband Transistor BFT 97

BFT 97 is an epitaxial NPN silicon planar RF transistor in a case similar to TO 119 (50 B 3 DIN 41867), intended for input stage applications in extremely low-noise broadband amplifiers up to 1 GHz.

Type	Ordering code
BFT 97	Q62702-F514

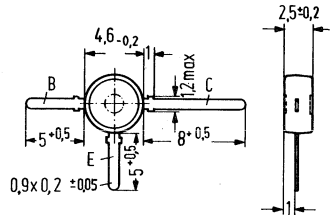

Approx. weight 0.25 g Dimensions in mm

Maximum ratings

Collector-emitter voltage	V_{CEO}	15	V
Collector-base voltage	V_{CBO}	20	V
Emitter-base voltage	V_{EBO}	2.5	V
Collector current	I_C	30	mA
Base current	I_B	4	mA
Junction temperature	T_j	150	°C
Storage temperature range	T_{stg}	-55 to +125	°C
Total power dissipation ($T_{amb} < 70^\circ\text{C}$)	P_{tot}	200	mW

Thermal resistance

Junction to ambient air ¹⁾	R_{thJA}	≤ 400	K/W
---------------------------------------	------------	------------	-----

1) mounted on glass fiber epoxy resin PCB 40 mm x 25 mm x 1.5 mm

Static characteristics ($T_{amb} = 25^{\circ}\text{C}$)

Collector-emitter breakdown voltage ($I_{CEO} = 500 \mu\text{A}$)	$V_{(BR)CEO}$	> 15	V
Collector-emitter breakdown voltage ($I_{CES} = 100 \mu\text{A}$)	$V_{(BR)CES}$	> 20	V
Emitter-base breakdown voltage ($I_{EBO} = 100 \mu\text{A}$)	$V_{(BR)EBO}$	> 2.5	V
Collector cutoff current ($V_{CBO} = 10 \text{ V}$)	I_{CBO}	< 50	nA
DC current gain ($I_C = 10 \text{ mA}$; $V_{CE} = 6 \text{ V}$)	h_{FE}	≥ 30	-

Dynamic characteristics ($T_{amb} = 25^{\circ}\text{C}$)

Small signal current gain ($I_C = 5 \text{ mA}$; $V_{CE} = 6 \text{ V}$; $f = 1 \text{ kHz}$)	h_{fe}	70	-
Transition frequency ($I_C = 20 \text{ mA}$; $V_{CE} = 6 \text{ V}$; $f = 200 \text{ MHz}$)	f_T	4 (> 3.6)	GHz
Reverse transfer capacitance ($I_C = 1 \text{ mA}$; $V_{CE} = 6 \text{ V}$; $f = 1 \text{ MHz}$)	C_{12e}	0.6	pF
Noise figure ($I_C = 3 \text{ mA}$; $V_{CE} = 6 \text{ V}$; $f = 10 \text{ MHz}$; $R_g = 75 \Omega$)	NF	0.9	dB
($I_C = 3 \text{ mA}$; $V_{CE} = 6 \text{ V}$; $f = 200 \text{ MHz}$; $R_g = 75 \Omega$)	NF	1.2	dB
($I_C = 4 \text{ mA}$; $V_{CE} = 6 \text{ V}$; $f = 800 \text{ MHz}$; $R_g = 60 \Omega$)	NF	2.1	dB
Output voltage ¹⁾ ($I_C = 20 \text{ mA}$; $V_{CE} = 6 \text{ V}$; $R_g = R_L = 75 \Omega$; $d_{IM} = 60 \text{ dB}$)	V_0	240	mV

1) Three tone modulation f approx. 800 MHz

S parameterOperating point: $V_{CE} = 6 \text{ V}$; $I_C = 3 \text{ mA}$; $Z_o = 50 \Omega$

f (GHz)	S_{11e}	φ	S_{21e}	φ	S_{12e}	φ	S_{22e}	φ	G_{max} (dB)
0,1	0,890	- 24	7,257	155	0,028	69	0,970	-12	36,3
0,2	0,789	- 49	6,688	138	0,049	59	0,873	-20	27,0
0,3	0,685	- 72	6,056	124	0,063	52	0,760	-24	22,1
0,4	0,591	- 91	5,317	114	0,070	48	0,683	-27	19,1
0,5	0,539	-108	4,535	105	0,075	47	0,650	-31	17,0
0,6	0,483	-123	4,030	97	0,082	45	0,634	-31	15,5
0,7	0,470	-135	3,610	91	0,086	46	0,583	-33	14,0
0,8	0,445	-144	3,232	86	0,090	49	0,586	-36	13,0
0,9	0,430	-154	2,899	82	0,093	49	0,561	-37	11,8
1,0	0,423	-163	2,620	77	0,097	51	0,555	-39	10,8
1,1	0,436	-171	2,407	72	0,102	52	0,536	-40	10,0
1,2	0,429	-177	2,245	68	0,108	53	0,535	-43	9,4
1,3	0,445	176	2,092	66	0,113	56	0,524	-45	8,8
1,4	0,422	168	1,907	62	0,120	54	0,526	-49	7,9
1,5	0,478	170	1,816	60	0,120	61	0,525	-49	7,7
1,6	0,467	166	1,716	56	0,129	61	0,521	-50	7,1
1,7	0,494	161	1,630	53	0,137	62	0,500	-55	6,7
1,8	0,490	158	1,538	51	0,143	64	0,524	-57	6,3
1,9	0,515	154	1,454	48	0,151	64	0,490	-59	5,8
2,0	0,519	153	1,395	45	0,159	64	0,511	-62	5,6

Operating point: $V_{CE} = 6 \text{ V}$; $I_C = 15 \text{ mA}$, $Z_o = 50 \Omega$

0,1	0,555	- 58	22,728	134	0,020	62	0,765	-26	32,6
0,2	0,378	-102	15,810	111	0,030	61	0,581	-28	26,4
0,3	0,312	-127	11,338	100	0,040	63	0,488	-27	22,7
0,4	0,281	-146	8,824	94	0,049	66	0,439	-27	20,2
0,5	0,286	-158	7,086	89	0,058	68	0,429	-30	18,3
0,6	0,281	-167	5,960	84	0,068	68	0,428	-28	16,7
0,7	0,292	-174	5,194	81	0,080	69	0,394	-31	15,4
0,8	0,288	178	4,586	78	0,089	70	0,409	-33	14,4
0,9	0,298	172	4,039	75	0,097	70	0,390	-34	13,2
1,0	0,301	167	3,634	72	0,107	70	0,389	-37	12,3
1,1	0,317	163	3,318	68	0,117	69	0,377	-38	11,5
1,2	0,320	158	3,076	66	0,127	68	0,377	-42	10,9
1,3	0,343	155	2,850	64	0,138	68	0,371	-44	10,3
1,4	0,324	148	2,593	61	0,147	66	0,368	-49	9,4
1,5	0,374	154	2,475	60	0,151	70	0,360	-47	9,1
1,6	0,367	151	2,333	57	0,163	68	0,356	-49	8,6
1,7	0,396	148	2,204	55	0,173	67	0,335	-54	8,1
1,8	0,395	146	2,079	52	0,182	67	0,358	-56	7,7
1,9	0,427	144	1,983	49	0,190	65	0,322	-57	7,3
2,0	0,427	144	1,902	47	0,199	65	0,338	-62	7,0

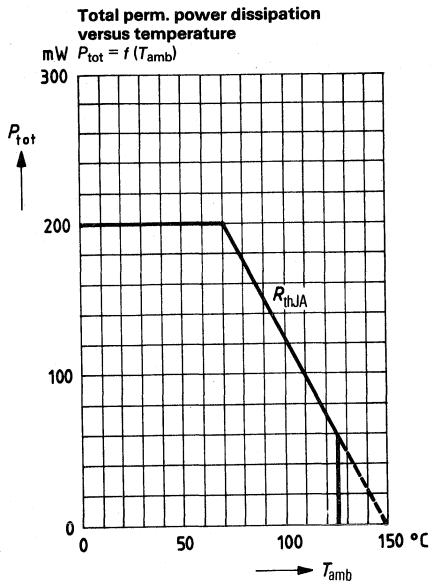

BFT 98 and BFT 99 are epitaxial NPN silicon planar RF transistors including integrated emitter stabilizing resistors.

They are intended for use in broadband amplifier output stages of low distortion, preferably in antenna amplifiers up to 1 GHz.

The high performance package is similar to TO 117 with threaded stud, the transistor terminals are insulated from the threaded stud.

Type	Ordering code
BFT 98	Q62702-F523
BFT 99	Q62702-F524

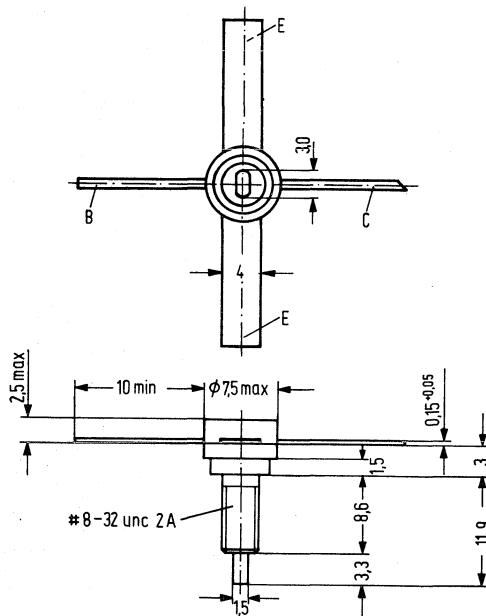

Approx. weight 1.9 g Dimensions in mm

Maximum ratings

Collector-emitter voltage	V_{CE0}	20	V
Collector-emitter voltage ($R_{BE} = 0$)	V_{CES}	30	V
Base-emitter voltage	V_{EBO}	3	V
Collector current ($V_{CE} \leq 10$ V)	I_C	200	mA
Collector peak current ($t < 100$ μ s)	I_{CM}	250	mA
Base current	I_B	50	mA
Junction temperature	T_j	150	$^{\circ}$ C
Storage temperature range	T_{stg}	-65 to +175	$^{\circ}$ C
Total power dissipation ($T_{case} = 70^{\circ}$ C)	P_{tot}	2,25	W

	BFT 98	BFT 99	
V_{CE0}	20	20	V
V_{CES}	30	30	V
V_{EBO}	3	3	V
I_C	200	350	mA
I_{CM}	250	500	mA
I_B	50	50	mA
T_j	150	150	$^{\circ}$ C
T_{stg}	-65 to +175	-65 to +175	$^{\circ}$ C
P_{tot}	2,25	4	W

Thermal resistance

Junction to case	R_{thJC}	≤ 35	≤ 20	K/W
------------------	------------	-----------	-----------	-----

Static characteristics ($T_{amb} = 25^{\circ}\text{C}$)

Collector cutoff current ($V_{CE0} = 30\text{ V}$)
DC current gain ($I_C = 120\text{ mA}$; $V_{CE} = 5\text{ V}$)

	BFT 98	BFT 99	
I_{CES}	≤ 1	≤ 1	mA
h_{FE}	≥ 25	≥ 25	-

Dynamic characteristics

Transition frequency

($I_C = 120\text{ mA}$; $V_{CE} = 5\text{ V}$; $f = 200\text{ MHz}$)

Reverse transfer capacitance

($I_C = 1\text{ mA}$; $V_{CE} = 15\text{ V}$; $f = 1\text{ MHz}$)

Collector-case capacitance

Power gain

($I_C = 120\text{ mA}$; $V_{CE} = 15\text{ V}$; $f = 800\text{ MHz}$; $Z_g = Z_{opt.}$)

($I_C = 200\text{ mA}$; $R_g = 60\ \Omega$)

Output voltage¹⁾

($I_C = 120\text{ mA}$; $V_{CE} = 15\text{ V}$; $d_{IM} = 60\text{ dB}$; $R_g = R_L = 75\ \Omega$)

($I_C = 200\text{ mA}$; $V_{CE} = 15\text{ V}$; $d_{IM} = 60\text{ dB}$; $R_g = R_L = 75\ \Omega$)

f_T	3	3	GHz
C_{12e}	1	1.9	pF
C_{Ccase}	0.8	0.8	pF
$G_{pe\ opt.}$	15	-	dB
$G_{pe\ opt.}$	-	12	dB
V_O	1.2	-	V
V_O	-	1.5	V

1) Three tone modulation f approx. 800 MHz

S parameterOperating point: $V_{CE} = 15 \text{ V}$, $I_C = 90 \text{ mA}$, $Z_o = 50 \Omega$

f (GHz)	S_{11}	φ	S_{21}	φ	S_{12}	φ	S_{22}	φ
0,1	0,615	-147	25,02	115	0,014	41	0,578	- 44
0,2	0,697	-171	13,92	94	0,017	37	0,385	- 52
0,3	0,723	176	9,52	83	0,022	38	0,323	- 55
0,4	0,738	167	7,17	74	0,024	42	0,293	- 58
0,5	0,749	160	5,69	67	0,027	42	0,273	- 64
0,6	0,757	154	4,72	60	0,032	43	0,266	- 73
0,7	0,748	148	4,00	53	0,035	44	0,276	- 80
0,8	0,763	141	3,46	46	0,039	44	0,281	- 86
0,9	0,781	137	3,06	40	0,043	42	0,290	- 94
1,0	0,782	133	2,72	35	0,047	42	0,308	-101
1,1	0,792	128	2,45	30	0,052	41	0,328	-107
1,2	0,783	124	2,20	23	0,056	40	0,347	-114
1,3	0,775	120	1,98	17	0,057	38	0,370	-118
1,4	0,779	117	1,81	10	0,059	36	0,382	-124
1,5	0,771	114	1,68	6	0,063	34	0,402	-131
1,6	0,780	111	1,53	2	0,066	40	0,413	-135
1,7	0,811	105	1,47	-1	0,077	38	0,424	-138
1,8	0,812	101	1,40	-6	0,083	34	0,435	-142
1,9	0,811	97	1,30	-10	0,091	32	0,448	-145
2,0	0,804	91	1,19	-15	0,097	30	0,449	-150

Operating point: $V_{CE} = 15 \text{ V}$, $I_C = 120 \text{ mA}$, $Z_o = 50 \Omega$

0,1	0,628	-148	25,00	115	0,015	45	0,574	- 44
0,2	0,700	-171	13,88	94	0,018	38	0,382	- 52
0,3	0,727	176	9,48	83	0,021	36	0,321	- 55
0,4	0,740	167	7,14	74	0,023	41	0,295	- 58
0,5	0,750	160	5,67	67	0,028	40	0,273	- 64
0,6	0,757	154	4,70	59	0,032	43	0,266	- 73
0,7	0,748	148	3,97	53	0,035	43	0,278	- 79
0,8	0,765	141	3,43	46	0,039	44	0,284	- 86
0,9	0,778	137	3,04	40	0,044	43	0,291	- 94
1,0	0,782	132	2,71	34	0,047	42	0,308	-101
1,1	0,794	128	2,44	29	0,052	41	0,329	-107
1,2	0,784	124	2,18	23	0,056	40	0,349	-114
1,3	0,775	121	1,97	17	0,057	38	0,370	-119
1,4	0,775	117	1,79	10	0,057	35	0,385	-124
1,5	0,771	114	1,67	5	0,063	34	0,401	-131
1,6	0,782	112	1,53	2	0,065	39	0,414	-134
1,7	0,811	105	1,47	-2	0,077	38	0,425	-138
1,8	0,814	101	1,40	-6	0,084	34	0,436	-142
1,9	0,812	97	1,29	-10	0,090	32	0,449	-146
2,0	0,803	91	1,18	-15	0,096	30	0,448	-150

S parameterOperating point: $V_{CE} = 15 \text{ V}$, $I_C = 160 \text{ mA}$, $Z_o = 50 \Omega$

f (GHz)	S_{11}	φ	S_{21}	φ	S_{12}	φ	S_{22}	φ
0,1	0,787	-167	21,44	102	0,016	34	0,359	- 96
0,2	0,817	179	11,07	87	0,017	37	0,247	-124
0,3	0,830	172	7,45	78	0,023	42	0,215	-140
0,4	0,837	166	5,59	71	0,026	46	0,207	-152
0,5	0,842	162	4,41	64	0,031	45	0,213	-159
0,6	0,847	157	3,66	57	0,036	46	0,233	-165
0,7	0,829	152	3,09	51	0,041	45	0,248	-168
0,8	0,847	147	2,69	45	0,046	44	0,259	-173
0,9	0,859	144	2,38	39	0,053	43	0,285	-176
1,0	0,856	141	2,12	34	0,056	42	0,305	-178
1,1	0,867	137	1,91	29	0,063	39	0,318	178
1,2	0,853	134	1,76	22	0,068	37	0,345	174
1,3	0,849	131	1,60	17	0,072	35	0,361	173
1,4	0,841	128	1,44	10	0,077	32	0,373	172
1,5	0,840	126	1,34	6	0,079	30	0,386	168
1,6	0,838	124	1,22	2	0,086	29	0,413	165
1,7	0,859	118	1,17	-2	0,092	27	0,432	161
1,8	0,860	114	1,13	-7	0,100	24	0,441	157
1,9	0,851	111	1,05	-10	0,110	24	0,450	154
2,0	0,842	106	0,97	-15	0,115	20	0,451	150

Operating point: $V_{CE} = 15 \text{ V}$, $I_C = 200 \text{ mA}$, $Z_o = 50 \Omega$

0,1	0,786	-167	21,58	101	0,015	34	0,345	- 99
0,2	0,818	178	11,11	86	0,017	39	0,238	-127
0,3	0,829	172	7,47	78	0,022	40	0,213	-142
0,4	0,838	166	5,60	71	0,027	48	0,204	-153
0,5	0,843	161	4,42	64	0,032	46	0,212	-160
0,6	0,843	157	3,66	57	0,037	47	0,232	-166
0,7	0,830	152	3,10	51	0,041	46	0,245	-169
0,8	0,845	147	2,69	45	0,046	44	0,258	-174
0,9	0,859	144	2,39	39	0,053	43	0,282	-177
1,0	0,855	140	2,13	34	0,057	42	0,303	-178
1,1	0,868	137	1,92	29	0,063	40	0,316	178
1,2	0,853	134	1,76	23	0,068	38	0,342	174
1,3	0,851	131	1,60	17	0,073	35	0,360	173
1,4	0,843	128	1,44	10	0,076	30	0,372	172
1,5	0,839	126	1,33	6	0,081	27	0,384	168
1,6	0,839	123	1,23	2	0,080	26	0,410	165
1,7	0,858	118	1,18	-2	0,091	27	0,429	161
1,8	0,858	114	1,13	-7	0,099	24	0,438	157
1,9	0,851	111	1,06	-10	0,108	22	0,448	154
2,0	0,841	106	0,98	-15	0,115	20	0,444	150

Total perm. power dissipation versus temperature

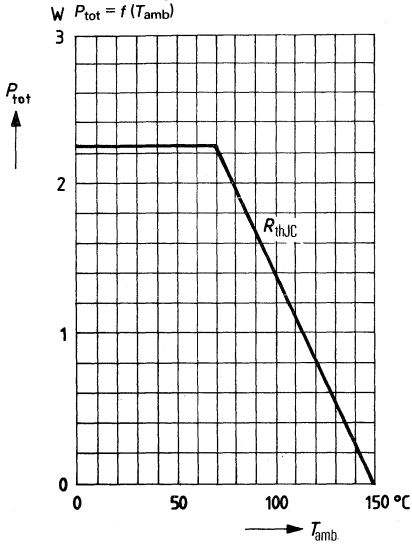

Total perm. power dissipation versus temperature

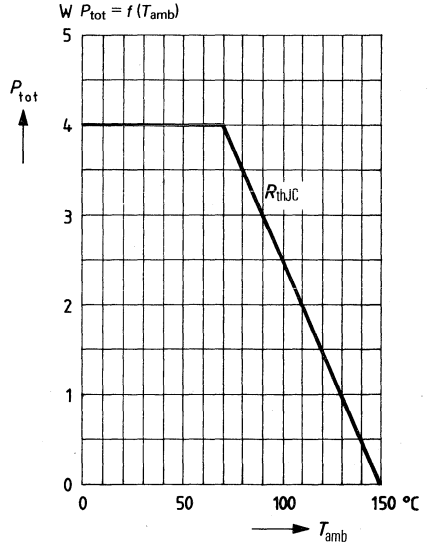

Perm. operating range $I_C = f(V_{CE})$
 $T_{case} = 70^\circ\text{C}; R_{thJc} = 35 \text{ K/W}$

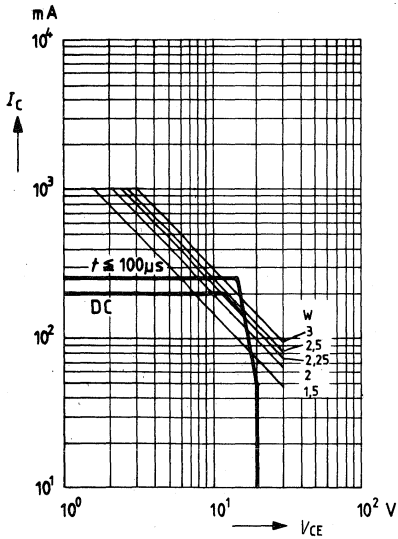

Perm. operating range $I_C = f(V_{CE})$
 $T_{case} = 70^\circ\text{C}; R_{thJc} \leq 20 \text{ K/W}$

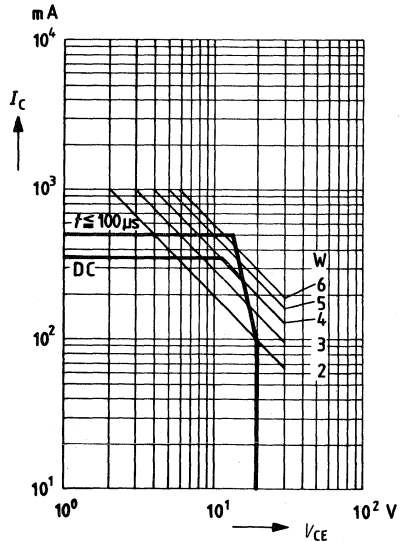

BFW 16 A is an epitaxial NPN silicon planar RF transistor in TO 39 metal case (5 C 3 DIN 41873) intended for general applications up to the GHz range, e.g. for driver and output stages of channel and range antenna amplifiers up to band V, as well as for vertical amplifier output stages in broadband oscillographs. The collector is conductively connected to the case.

Type	Ordering code
BFW 16 A	Q62702-F319

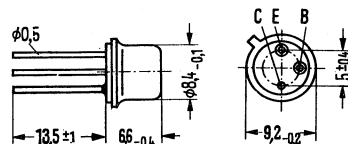

Approx. weight 1.6 g Dimensions in mm

Maximum ratings

Collector-base voltage	V_{CBO}	40	V
Collector-emitter voltage ($R_{BE} \leq 50 \Omega$)	V_{CER}	40	V
Collector-emitter voltage	V_{CEO}	25	V
Emitter-base voltage	V_{EBO}	2	V
Collector current	I_C	150	mA
Collector peak current ($f \geq 1$ MHz)	I_{CM}	300	mA
Junction temperature	T_j	200	°C
Storage temperature range	T_{stg}	-65 to +200	°C
Total power dissipation ($T_{case} = 125^\circ\text{C}$)	P_{tot}	1.5	W

Thermal resistance

Junction to ambient air	R_{thJA}	≤ 250	K/W
Junction to case	R_{thJC}	≤ 50	K/W

Static characteristics ($T_{amb} = 25^{\circ}\text{C}$)

Collector cutoff current

($V_{CB0} = 20\text{ V}$; $T_{amb} = 125^{\circ}\text{C}$)

I_{CB0}	≤ 20	μA
-----------	-----------	---------------

Collector-emitter saturation voltage¹⁾

($I_C = 100\text{ mA}$)

V_{CEsat}	≤ 0.75	V
-------------	-------------	------------

DC current gain

($I_C = 50\text{ mA}$; $V_{CE} = 5\text{ V}$)

h_{FE}	≥ 25	-
----------	-----------	---

($I_C = 150\text{ mA}$; $V_{CE} = 5\text{ V}$)

h_{FE}	≥ 25	-
----------	-----------	---

Dynamic characteristics ($T_{amb} = 25^{\circ}\text{C}$)

Transition frequency

($I_C = 150\text{ mA}$; $V_{CE} = 15\text{ V}$; $f = 200\text{ MHz}$)

f_T	1.2	GHz
-------	-----	--------------

Reverse transfer capacitance

($I_C = 10\text{ mA}$; $V_{CE} = 15\text{ V}$; $f = 1\text{ MHz}$)

C_{12e}	1.7	pF
-----------	-----	-------------

Collector-base capacitance

($V_{CB0} = 15\text{ V}$; $f = 1\text{ MHz}$)

C_{CB0}	≤ 4	pF
-----------	----------	-------------

Power gain

($I_C = 70\text{ mA}$; $V_{CE} = 18\text{ V}$; $f = 200\text{ MHz}$; $R_g = 60\ \Omega$)

G_{pe}	16	dB
----------	----	-------------

($I_C = 70\text{ mA}$; $V_{CE} = 18\text{ V}$; $f = 800\text{ MHz}$; $R_g = 60\ \Omega$)

G_{pe}	6.5	dB
----------	-----	-------------

Noise figure

($I_C = 30\text{ mA}$; $V_{CE} = 15\text{ V}$;

$f = 200\text{ MHz}$; $R_g = 75\ \Omega$)

NF	≤ 6	dB
------	----------	-------------

Output voltage²⁾

($I_C = 70\text{ mA}$; $V_{CE} = 18\text{ V}$; $R_L = R_g = 75\ \Omega$;

$d_{IM} = 60\text{ dB}$)

V_o	600	mV
-------	-----	-------------

S parameter

Operating point: $I_C = 70\text{ mA}$, $V_{CE} = 18\text{ V}$; $Z_o = 50\ \Omega$

f (GHz)	S_{11}	φ	S_{21}	φ	S_{12}	φ	S_{22}	φ	G_{max} (dB)
0,2	0,547	-178	5,537	78	0,061	70	0,259	- 58	16,7
0,3	0,540	172	3,750	69	0,088	72	0,283	- 65	13,3
0,4	0,551	165	2,803	61	0,115	74	0,309	- 72	11,0
0,5	0,568	159	2,179	55	0,140	74	0,336	- 81	9,0
0,6	0,583	155	1,822	47	0,162	73	0,379	- 91	7,7
0,7	0,585	151	1,547	41	0,192	71	0,441	- 99	6,6
0,8	0,579	146	1,356	35	0,219	71	0,505	-103	5,7
0,9	0,572	141	1,181	30	0,248	69	0,556	-106	4,8
1,0	0,568	136	1,075	26	0,273	68	0,581	-109	4,1

1) Applicable to that characteristic passing through $I_C = 110\text{ mA}$, $V_{CE} = 1\text{ V}$ at constant I_B .

2) Measured with three tone modulation f approx. 800 MHz

**Total perm. power dissipation
versus temperature**

W $P_{\text{tot}} = f(T); R_{\text{th}} = \text{parameter}$

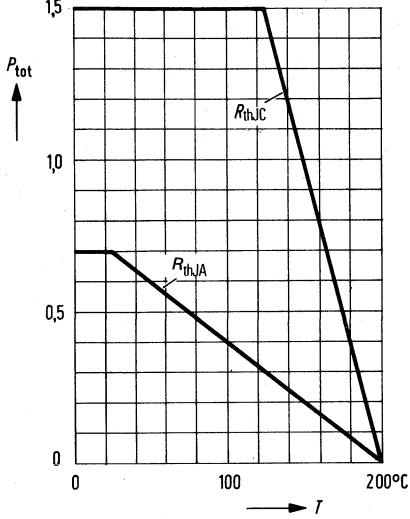

Not for new design

BFW 30 is an epitaxial NPN silicon planar RF transistor in a TO 72 case (18 A 4 DIN 41876), designed for universal application up to the GHz range, e. g. for vertical amplifiers in broadband oscillographs and for broadband antenna amplifiers. The terminals E, B, C are insulated from the case.

Type	Ordering code
BFW 30	Q62702-F320

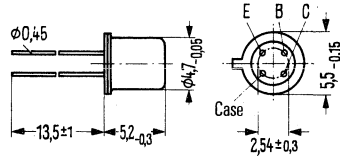

Approx. weight 0.4 g Dimensions in mm

Maximum ratings

Collector-base voltage	V_{CBO}	20	V
Collector-emitter voltage	V_{CEO}	10	V
Emitter-base voltage	V_{EBO}	2.5	V
Collector current	I_C	50	mA
Collector-peak current ($f \geq 1$ MHz)	I_{CM}	100	mA
Junction temperature	T_j	200	°C
Storage temperature range	T_{stg}	-65 to +175	°C
Total power dissipation ($T_{amb} \leq 25^\circ\text{C}$)	P_{tot}	250	mW

Thermal resistance

Junction to ambient air	R_{thJA}	≤ 700	K/W
Junction to case	R_{thJC}	≤ 400	K/W

Static characteristics ($T_{amb} = 25^{\circ}\text{C}$)

Collector cutoff current ($V_{CBO} = 10\text{ V}$)

I_{CBO}	≤ 50	nA
-----------	-----------	----

DC current gain

($I_C = 25\text{ mA}$; $V_{CE} = 5\text{ V}$)

h_{FE}	≥ 25	-
----------	-----------	---

($I_C = 50\text{ mA}$; $V_{CE} = 5\text{ V}$)

h_{FE}	≥ 25	-
----------	-----------	---

Dynamic characteristics ($T_{amb} = 25^{\circ}\text{C}$)

Transition frequency

($I_C = 50\text{ mA}$; $V_{CE} = 5\text{ V}$; $f = 200\text{ MHz}$)

f_T	1.6	GHz
-------	-----	-----

Reverse transfer capacitance

($I_C = 2\text{ mA}$; $V_{CE} = 5\text{ V}$; $f = 1\text{ MHz}$)

C_{12e}	0.8	pF
-----------	-----	----

Collector-base capacitance ($V_{CBO} = 5\text{ V}$; $f = 1\text{ MHz}$)

C_{CBO}	≤ 1.5	pF
-----------	------------	----

Power gain

($I_C = 30\text{ mA}$; $V_{CE} = 5\text{ V}$; $f = 200\text{ MHz}$; $R_g = 60\ \Omega$)

G_{pe}	21 (≥ 19)	dB
----------	------------------	----

($I_C = 30\text{ mA}$; $V_{CE} = 5\text{ V}$; $f = 800\text{ MHz}$; $R_g = 60\ \Omega$)

G_{pe}	7.5	dB
----------	-----	----

Noise figure

($I_C = 2\text{ mA}$; $V_{CE} = 5\text{ V}$; $f = 500\text{ MHz}$; $R_g = 60\ \Omega$)

NF	≤ 5	dB
----	----------	----

Output voltage¹⁾

($I_C = 30\text{ mA}$, $V_{CE} = 5\text{ V}$; $d_{IM} = 60\text{ dB}$;

$R_g = R_L = 75\ \Omega$)

V_0	350	mV
-------	-----	----

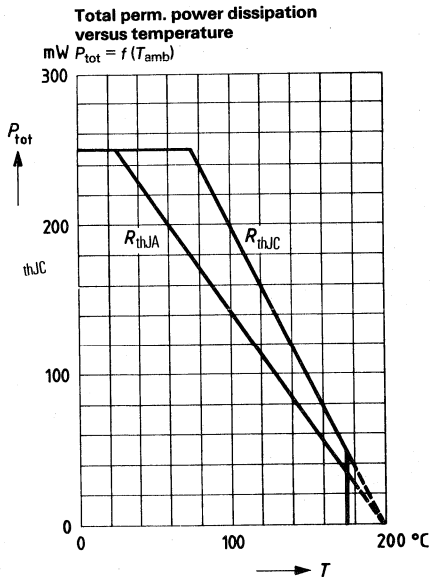

1) Three tone modulation f approx. 800 MHz

S parameterOperating point: $V_{CE} = 5 \text{ V}$, $I_C = 30 \text{ mA}$, $Z_o = 50 \Omega$

f (MHz)	S_{11}	φ	S_{21}	φ	S_{12}	φ	S_{22}	φ
0,1	0,171	-89	11,49	107	0,036	74	0,580	-17
0,2	0,133	-126	6,20	94	0,064	80	0,494	-13
0,3	0,133	-148	4,26	89	0,093	82	0,465	-11
0,4	0,154	-160	3,27	84	0,122	84	0,450	-10
0,5	0,177	-165	2,67	80	0,150	85	0,417	-11
0,6	0,197	-168	2,28	77	0,178	86	0,402	-15
0,7	0,214	-171	1,98	73	0,201	87	0,399	-17
0,8	0,230	-172	1,84	69	0,229	88	0,399	-20
0,9	0,224	-170	1,69	68	0,260	89	0,406	-24
1,0	0,221	-172	1,54	66	0,286	89	0,419	-27
1,1	0,204	-173	1,42	63	0,309	90	0,447	-28
1,2	0,183	-172	1,33	59	0,332	89	0,465	-31
1,3	0,138	-168	1,26	57	0,355	88	0,501	-32
1,4	0,100	-168	1,17	53	0,372	87	0,515	-32
1,5	0,061	-162	1,11	49	0,390	83	0,534	-35
1,6	0,039	-127	1,05	45	0,409	80	0,564	-37
1,7	0,068	-80	0,99	40	0,416	77	0,605	-41
1,8	0,142	-83	0,87	31	0,393	71	0,650	-49
1,9	0,299	-97	0,69	17	0,321	61	0,734	-60
2,0	0,559	-124	0,32	4	0,161	62	0,786	-81

BFW 92 is an epitaxial NPN silicon planar RF transistor in a plastic package similar to TO 119 (50 B 3 DIN 41867); intended for use as RF amplifier up to the GHz range, e. g. for broadband antenna amplifiers. This transistor is also available upon request as JEDEC version under the designation 2N6621.

Type	Ordering code
BFW 92	Q62702-F321
2 N 6621	Q68000-A4669

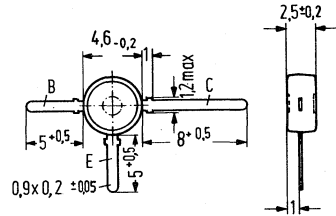

Approx. weight 0.3 g Dimensions in mm

Maximum ratings

- Collector-base voltage
- Collector-emitter voltage
- Emitter-base voltage
- Collector current
- Collector peak current ($f > 1$ MHz)
- Junction temperature
- Storage temperature range
- Total power dissipation ($T_{amb} = 70^\circ\text{C}$)

	BFW 92 2 N 6621	
V_{CBO}	25	V
V_{CEO}	15	V
V_{EBO}	2.5	V
I_C	25	mA
I_{CM}	50	mA
T_j	150	$^\circ\text{C}$
T_{stg}	-55 to +125	$^\circ\text{C}$
P_{tot}	200	mW

Thermal resistance

- Junction to ambient air
(mounted on glass fiber epoxy resin
PCB 40 mm x 25 mm x 1 mm)

R_{thJA}	400	K/W
------------	-----	-----

Static characteristics ($T_{amb} = 25^\circ\text{C}$)

Collector cutoff current ($V_{CBO} = 10\text{ V}$)	I_{CBO}	≤ 50	nA
Collector-emitter saturation voltage ¹⁾ ($I_C = 20\text{ mA}$)	V_{CEsat}	≤ 0.75	V
DC current gain ($I_C = 2\text{ mA}$; $V_{CE} = 1\text{ V}$)	h_{FE}	20 to 150	-
($I_C = 25\text{ mA}$; $V_{CE} = 1\text{ V}$)	h_{FE}	≥ 20	-

Dynamic characteristics ($T_{amb} = 25^\circ\text{C}$)

Transition frequency ($I_C = 14\text{ mA}$; $V_{CE} = 5\text{ V}$; $f = 200\text{ MHz}$)	f_T	1.9	GHz
Reverse transfer capacitance ($I_C = 2\text{ mA}$; $V_{CE} = 5\text{ V}$; $f = 1\text{ MHz}$)	C_{12e}	0.6	pF
Collector-base capacitance ($V_{CBO} = 10\text{ V}$; $f = 1\text{ MHz}$)	C_{CBO}	0.7	pF
Power gain ($I_C = 14\text{ mA}$; $V_{CE} = 5\text{ V}$; $f = 800\text{ MHz}$; $R_g = 60\ \Omega$)	G_{pe}	11	dB
Noise figure ($I_C = 2\text{ mA}$; $V_{CE} = 5\text{ V}$; $f = 800\text{ MHz}$; $R_g = 60\ \Omega$)	NF	4	dB
Output voltage ²⁾ ($I_C = 14\text{ mA}$; $V_{CE} = 5\text{ V}$; $R_g = R_L = 75\ \Omega$ $d_{IM} = 60\text{ dB}$)	V_o	150	mV

S parameter

Operating point: $I_C = 14\text{ mA}$; $V_{CE} = 5\text{ V}$; $Z_o = 60\ \Omega$

f (GHz)	S_{11}	φ	S_{21}	φ	S_{12}	φ	S_{22}	φ
0,1	0,445	- 73	16,307	131	0,017	58	0,810	-14
0,2	0,345	-118	10,622	109	0,027	62	0,678	-19
0,3	0,313	-142	7,400	98	0,034	64	0,646	-19
0,4	0,309	-157	5,750	90	0,043	65	0,611	-19
0,5	0,311	-169	4,628	84	0,051	69	0,594	-22
0,6	0,315	-178	3,919	80	0,059	72	0,617	-24
0,7	0,326	173	3,362	76	0,067	72	0,601	-23
0,8	0,337	168	2,926	71	0,077	73	0,572	-26
0,9	0,349	164	2,622	68	0,085	73	0,576	-31
1,0	0,357	159	2,344	63	0,094	74	0,602	-33

1) Applicable to that characteristic passing through $I_C = 22\text{ mA}$; $V_{CE} = 1\text{ V}$ at constant I_B .

2) Measured with three tone modulation f approx. 800 MHz

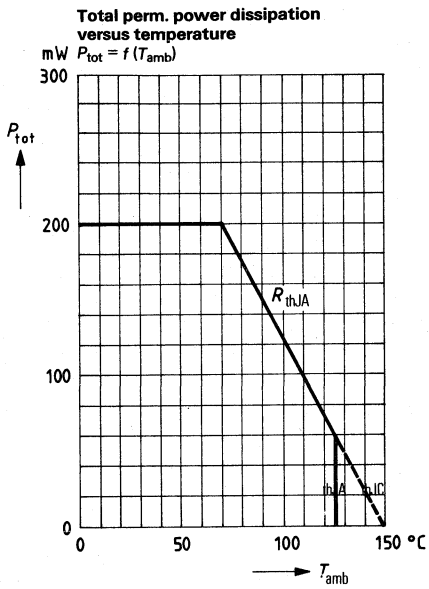

Static characteristics ($T_{amb} = 25^{\circ}\text{C}$)

Collector cutoff current ($V_{CB0} = 10\text{ V}$)	I_{CBO}	≤ 50	nA
DC current gain ($I_C = 25\text{ mA}$; $V_{CE} = 5\text{ V}$)	h_{FE}	≥ 25	-
($I_C = 50\text{ mA}$; $V_{CE} = 5\text{ V}$)	h_{FE}	≥ 25	-

Dynamic characteristics ($T_{amb} = 25^{\circ}\text{C}$)

Transition frequency ($I_C = 50\text{ mA}$; $V_{CE} = 5\text{ V}$; $f = 200\text{ MHz}$)	f_T	1.6	GHz
Reverse transfer capacitance ($I_C = 2\text{ mA}$; $V_{CE} = 5\text{ V}$; $f = 1\text{ MHz}$)	C_{12e}	0.6	pF
Collector-base capacitance ($V_{CB0} = 5\text{ V}$; $f = 1\text{ MHz}$)	C_{CB0}	1.5	pF
Power gain ($I_C = 30\text{ mA}$; $V_{CE} = 5\text{ V}$; $f = 200\text{ MHz}$; $R_g = 60\ \Omega$)	G_{pe}	23	dB
($I_C = 30\text{ mA}$; $V_{CE} = 5\text{ V}$; $f = 800\text{ MHz}$; $R_g = 60\ \Omega$)	G_{pe}	11	dB
Noise figure ($I_C = 2\text{ mA}$; $V_{CE} = 5\text{ V}$; $f = 500\text{ MHz}$; $R_g = 60\ \Omega$)	NF	≤ 5	dB
Output voltage ¹⁾ ($I_C = 30\text{ mA}$; $V_{CE} = 5\text{ V}$; $d_{IM} = 60\text{ dB}$; $R_g = R_L = 75\ \Omega$)	V_0	350	mV

S parameter: Operating point: $I_C = 30\text{ mA}$, $V_{CE} = 5\text{ V}$, $Z_0 = 50\ \Omega$

f (GHz)	S_{11}	φ	S_{21}	φ	S_{12}	φ	S_{22}	φ	G_{max} (dB)
0,1	0,346	-134	17,385	115	0,015	60	0,680	-20	28,1
0,2	0,372	-158	9,549	97	0,024	68	0,596	-17	22,2
0,3	0,384	-168	6,519	88	0,034	69	0,555	-15	18,6
0,4	0,396	-175	5,001	83	0,044	72	0,528	-17	16,1
0,5	0,422	-179	3,978	79	0,053	73	0,540	-22	14,3
0,6	0,431	177	3,322	73	0,062	73	0,556	-23	12,9
0,7	0,445	173	2,888	70	0,072	74	0,527	-26	11,6
0,8	0,447	169	2,534	66	0,081	75	0,547	-31	10,6
0,9	0,466	166	2,222	63	0,088	76	0,537	-33	9,5
1,0	0,468	163	1,981	59	0,098	75	0,542	-37	8,5
1,1	0,484	160	1,818	55	0,107	75	0,532	-40	7,8
1,2	0,491	156	1,681	52	0,117	75	0,534	-44	7,2
1,3	0,515	154	1,560	50	0,128	76	0,533	-48	6,6
1,4	0,521	152	1,443	47	0,138	77	0,531	-53	6,0
1,5	0,541	151	1,333	45	0,147	78	0,544	-54	5,5
1,6	0,534	149	1,260	41	0,157	77	0,538	-57	5,0
1,7	0,560	146	1,192	39	0,170	76	0,526	-64	4,6
1,8	0,559	145	1,120	36	0,181	76	0,546	-67	4,1
1,9	0,580	143	1,058	34	0,192	75	0,518	-71	3,6
2,0	0,583	142	1,013	32	0,206	74	0,537	-75	3,4

1) Three tone modulation f approx. 800 MHz

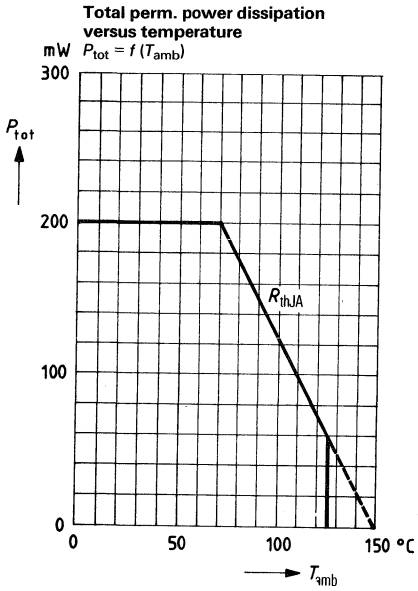

NPN Silicon Transistor for VHF Output Stages in Broadband Amplifiers

BFX 55

BFX 55 is an epitaxial NPN silicon planar transistor in a TO 39 case (5 C 3 DIN 41873). The collector has been electrically connected to the case. The transistor is especially suitable for use in VHF output stages of antenna channel and broadband amplifiers.

Type	Ordering code
BFX 55	Q60206-X55

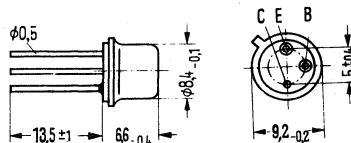

Approx. weight 1.5 g Dimensions in mm

Maximum ratings

Collector-emitter voltage	V_{CE0}	40	V
Collector-base voltage	V_{CB0}	60	V
Emitter-base voltage	V_{EBO}	3.5	V
Collector current	I_C	400	mA
Base current	I_B	100	mA
Junction temperature	T_j	200	°C
Storage temperature range	T_{stg}	-65 to +175	°C
Total power dissipation ($T_{case} \leq 68^\circ\text{C}$)	P_{tot}	2.2	W

Thermal resistance

Junction to ambient air	R_{thJA}	≤ 220	K/W
Junction to case	R_{thJC}	≤ 60	K/W

Test circuit for power gain $f = 200$ MHz

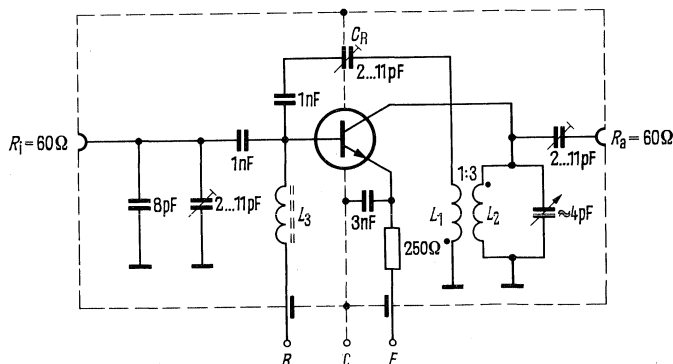

(Transistor cooled by mounted radiator of $R_{th} = 30$ K/W)

L_1 1 turn 0.5 CuLS (enameled, silk insulated copper wire)

L_2 3 turns 6.5 \emptyset , spacing 1.5 mm, 1 \emptyset silvered Cu

L_3 20 turns 0.5 CuLS on SIFERRIT core B 63310-A 3004-X 025 transformed load resistance $R_L = 450 \Omega$

Static characteristics ($T_{amb} = 25^{\circ}\text{C}$)

Collector cutoff current ($V_{CBO} = 40\text{ V}$)

$I_{CBO} \leq 50 \text{ nA}$

Collector-base breakdown voltage

$V_{(BR)CBS} > 60 \text{ V}$

($I_{CBS} = 100 \mu\text{A}$)

DC current gain ($I_C = 50\text{ mA}$; $V_{CE} = 5\text{ V}$)

$h_{FE} 30 \text{ to } 160$

Dynamic characteristics ($T_{amb} = 25^{\circ}\text{C}$)

Transition frequency ($I_C = 50\text{ mA}$; $V_{CE} = 15\text{ V}$)

$f_T 700 \text{ MHz}$

Reverse transfer capacitance

$C_{12e} 2.5 (< 3.5) \text{ pF}$

($I_C = 1\text{ mA}$; $V_{CE} = 10\text{ V}$; $f = 1\text{ MHz}$)

Power gain

$G_{pe} 16 \text{ dB}$

($f = 200\text{ MHz}$; $R_L = 450 \Omega$; see test circuit)

($I_C = 40\text{ mA}$; $V_{CB} = 25\text{ V}$)

Output voltage

$V_{o\text{ rms}} 2.4 \text{ V}$

($I_C = 40\text{ mA}$; $V_{CB} = 25\text{ V}$; $d_{IM} = 30\text{ dB}$; $R_L = 60 \Omega$)

Total perm. power dissipation versus temperature

$P_{tot} = f(T)$; R_{th} = parameter

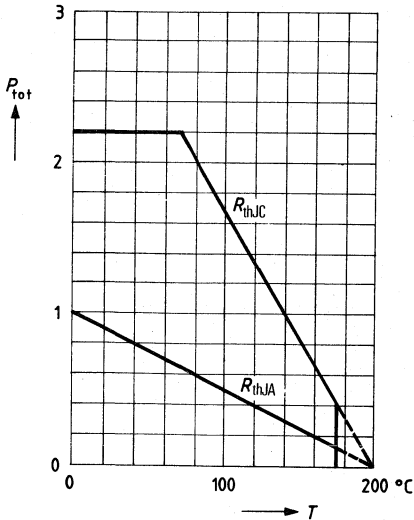

S parameterOperating point: $V_{CE} = 15 \text{ V}$, $I_C = 50 \text{ mA}$, $Z_o = 50 \Omega$

f (MHz)	S_{11}	φ	S_{21}	φ	S_{12}	φ	S_{22}	φ
0,1	0,470	-172	6,25	85	0,042	77	0,455	-13
0,2	0,505	176	3,18	73	0,078	84	0,444	-17
0,3	0,540	171	2,13	65	0,114	90	0,447	-24
0,4	0,577	165	1,66	56	0,158	94	0,452	-33
0,5	0,604	161	1,36	51	0,209	97	0,451	-45
0,6	0,634	157	1,12	47	0,272	98	0,464	-58
0,7	0,637	153	0,95	44	0,332	97	0,478	-70
0,8	0,644	148	0,84	43	0,398	95	0,498	-82
0,9	0,650	143	0,76	45	0,471	93	0,526	-92
1,0	0,639	139	0,69	46	0,532	90	0,535	-99
1,1	0,620	134	0,65	49	0,586	87	0,524	-106
1,2	0,599	128	0,64	51	0,630	83	0,526	-113
1,3	0,574	121	0,64	53	0,673	79	0,505	-117
1,4	0,559	116	0,65	54	0,705	76	0,480	-121
1,5	0,549	110	0,65	54	0,722	72	0,442	-129
1,6	0,557	105	0,66	54	0,741	68	0,439	-137
1,7	0,580	104	0,67	54	0,761	66	0,439	-144
1,8	0,585	105	0,66	53	0,742	63	0,453	-156
1,9	0,593	102	0,65	51	0,723	59	0,473	-165
2,0	0,647	103	0,64	50	0,706	56	0,505	-174

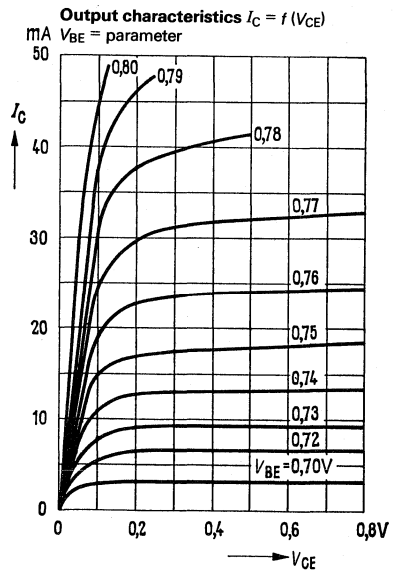
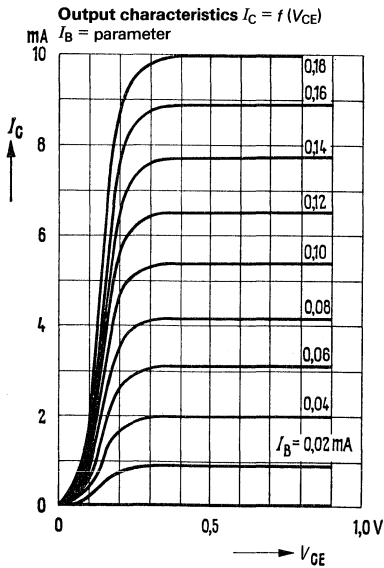
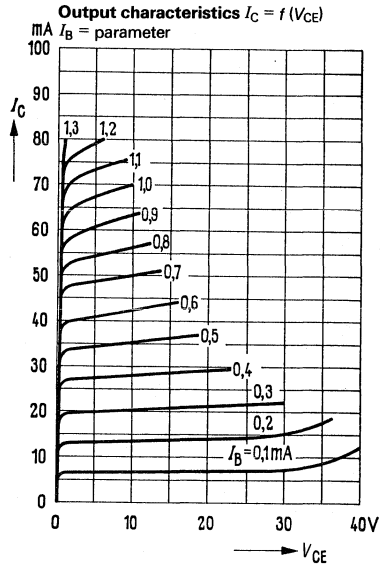
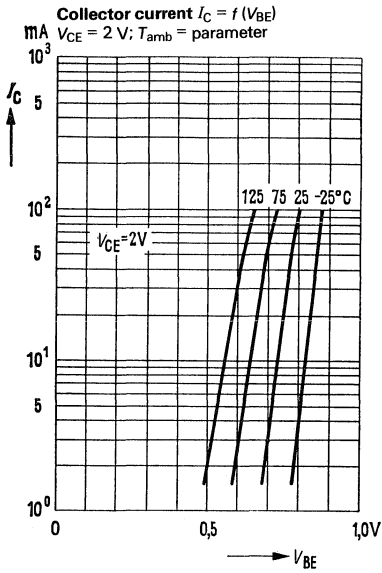

Collector-emitter saturation voltage

$V_{CEsat} = f(I_C)$

Base-emitter saturation voltage

$V_{BEsat} = f(I_C); h_{FE} = 20$

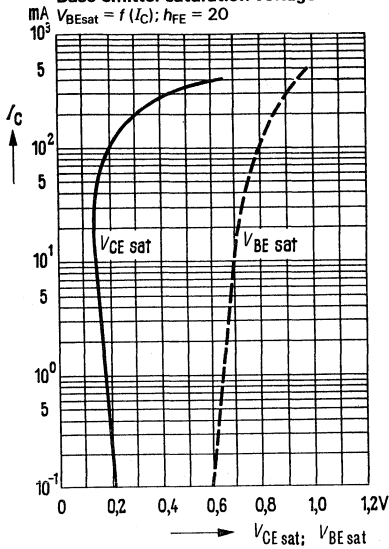

Collector cutoff current versus temperature

$I_{CBO} = f(T_{amb})$

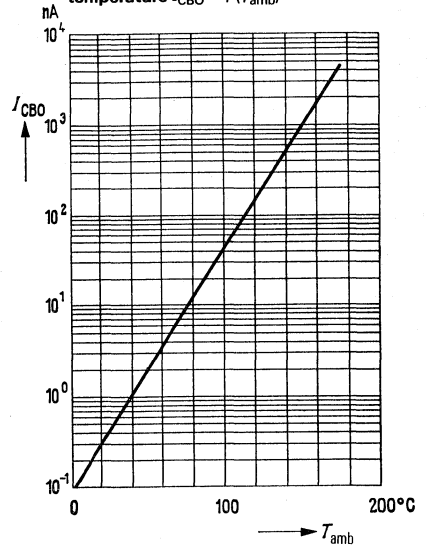

Transition frequency $f_T = f(I_C)$

$V_{CE} = \text{parameter}$

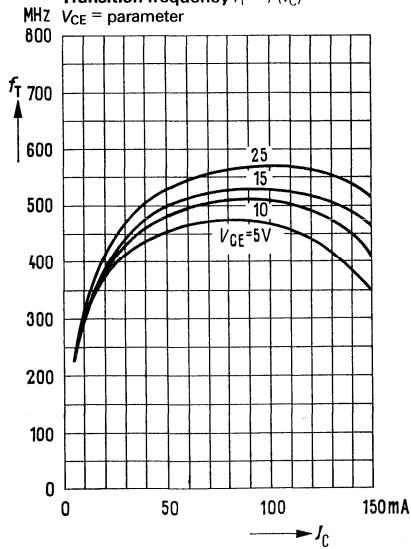

Reverse transfer capacitance

$C_{12e} = f(V_{CB})$

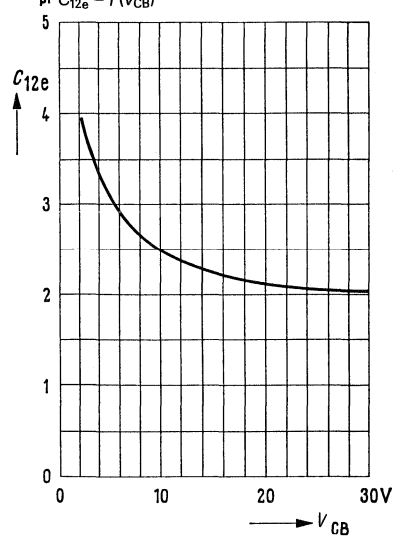

BFX 59 and BFX 59 F are epitaxial NPN silicon planar RF transistors in TO 72 case (18 A 4 DIN 41876). The leads are electrically insulated from the case. The transistors are suitable for use in low-power driver and output stages at frequencies up to the UHF range.

Type	Ordering code
BFX 59	Q60206-X59
BFX 59 F	Q60206-X59-S5

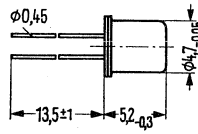

Approx. weight 0.4 g

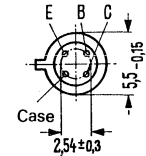

Dimensions in mm

Maximum ratings

Collector-emitter voltage
 Collector-base voltage
 Emitter-base voltage
 Collector current
 Base current
 Junction temperature
 Storage temperature range
 Total power dissipation ($T_{\text{case}} \leq 70^\circ\text{C}$)

	BFX 59	BFX 59 F	
V_{CEO}	20		V
V_{CBO}	30		V
V_{EBO}	3		V
I_{C}	100		mA
I_{B}	30		mA
T_{j}	200		$^\circ\text{C}$
T_{stg}	-65 to +175		$^\circ\text{C}$
P_{tot}	370		mW

Thermal resistance

Junction to ambient air
 Junction to case

R_{thJA}	≤ 650	K/W
R_{thJC}	≤ 350	K/W

Static characteristics ($T_{amb} = 25^{\circ}\text{C}$)		BFX 59	BFX 59 F	
Collector cutoff current ($V_{CBO} = 20\text{ V}$)	I_{CBO}	0.3 (≤ 10)	0.3 (≤ 10)	nA
Collector-emitter breakdown voltage ($I_{CEO} = 10\text{ mA}$)	$V_{(BR)CEO}$	> 20	> 20	V
Emitter-base breakdown voltage ($I_{EBO} = 10\text{ }\mu\text{A}$)	$V_{(BR)EBO}$	> 3	> 3	V

Dynamic characteristics ($T_{amb} = 25^{\circ}\text{C}$)

Small signal current gain ($I_C = 10\text{ mA}$; $V_{CE} = 10\text{ V}$; $f = 1\text{ kHz}$)	h_{fe}	30 to 200	30 to 200	-
Transition frequency ($I_C = 8\text{ mA}$; $V_{CE} = 10\text{ V}$; $f = 100\text{ MHz}$)	f_T	900 (> 600)	900 (> 600)	MHz
($I_C = 20\text{ mA}$; $V_{CE} = 10\text{ V}$; $f = 100\text{ MHz}$)	f_T	1000 (> 700)	1050 (> 700)	MHz
($I_C = 35\text{ mA}$; $V_{CE} = 10\text{ V}$; $f = 100\text{ MHz}$)	f_T	-	1000 (> 700)	MHz
Reverse transfer capacitance ($I_C = 1\text{ mA}$; $V_{CB} = 10\text{ V}$; $f = 1\text{ MHz}$)	C_{12e}	0.4 to 0.8	0.6 to 0.9	pF
Feedback time constant ($I_C = 10\text{ mA}$; $V_{CB} = 10\text{ V}$; $f = 30\text{ MHz}$)	$r_{bb} C_{bc}$	4	4	ps
Noise figure ($I_C = 3\text{ mA}$; $V_{CE} = 10\text{ V}$; $f = 200\text{ MHz}$; $R_g = 60\text{ }\Omega$)	NF	3.4 (< 4.5)	3.4 (< 4.5)	dB
($I_C = 3\text{ mA}$; $V_{CE} = 10\text{ V}$; $f = 300\text{ kHz}$; $R_g = 300\text{ }\Omega$)	NF	2.6	2.6	dB

S parameter

Operating point: $V_{CE} = 8\text{ V}$; $I_C = 30\text{ mA}$, $Z_o = 50\text{ }\Omega$

f (GHz)	S11e	φ	S21e	φ	S12e	φ	S22e	φ	G_{max} (dB)
0,1	0,337	-122	10,562	98	0,016	61	0,780	- 9	25,1
0,2	0,312	-150	5,702	83	0,028	68	0,762	-12	19,3
0,3	0,315	-166	3,807	74	0,038	72	0,767	-17	15,9
0,4	0,330	-179	2,779	65	0,048	74	0,769	-22	13,3
0,5	0,351	171	2,210	58	0,058	76	0,768	-26	11,3
0,6	0,372	163	1,839	50	0,068	78	0,783	-31	10,1
0,7	0,382	156	1,619	42	0,079	78	0,799	-36	9,3
0,8	0,509	144	1,451	29	0,147	83	0,720	-56	7,7
0,9	0,397	134	1,300	26	0,120	73	0,804	-51	7,5
1,0	0,406	123	1,135	19	0,130	74	0,815	-57	6,6

Total perm. power dissipation versus temperature
 $P_{tot} = f(T)$; R_{th} = parameter

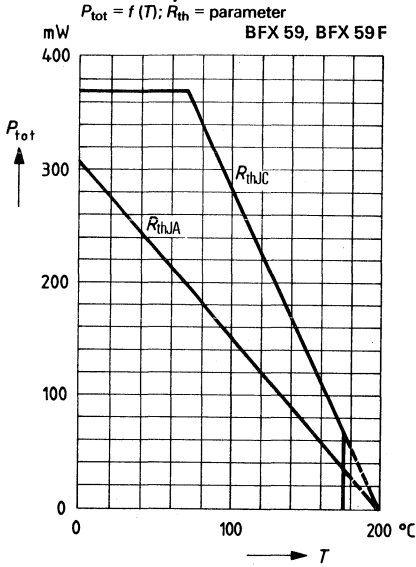

Output characteristics $I_C = f(V_{CE})$
 I_B = parameter

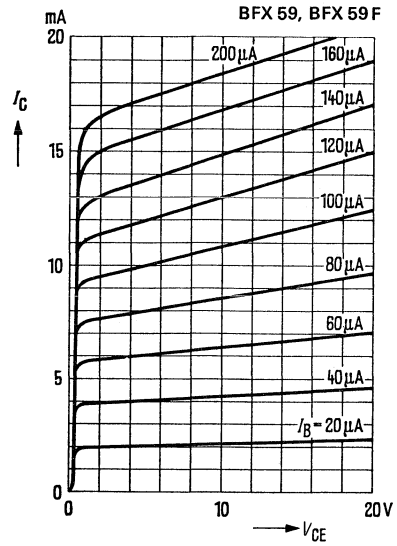

Reverse transfer capacitance
 $C_{12e} = f(V_{CB})$; $I_C = 1 \text{ mA}$; $f = 1 \text{ MHz}$

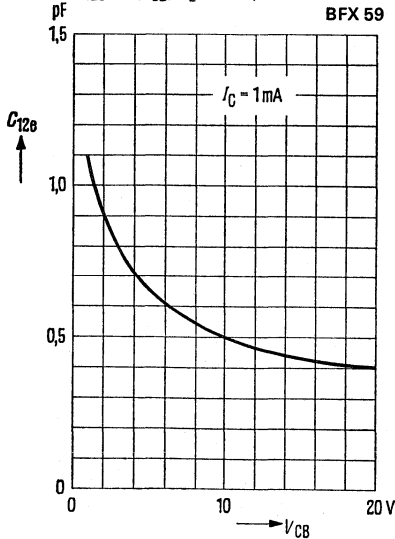

Transition frequency $f_T = f(I_C)$
 $f = 100 \text{ MHz}$

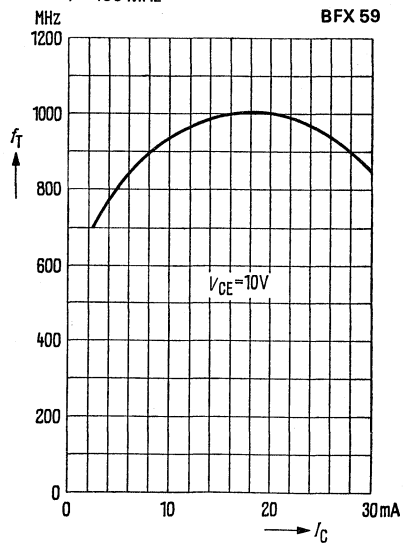

Reverse transfer capacitance
 $C_{12e} = f(V_{CB}); I_E = 1 \text{ mA}; f = 1 \text{ MHz}$

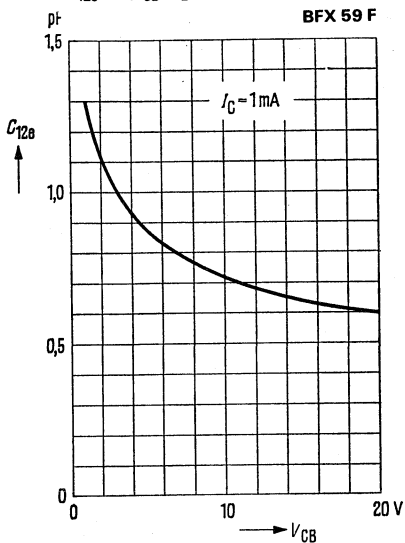

Transition frequency $f_T = f(I_C)$
 $f = 100 \text{ MHz}$

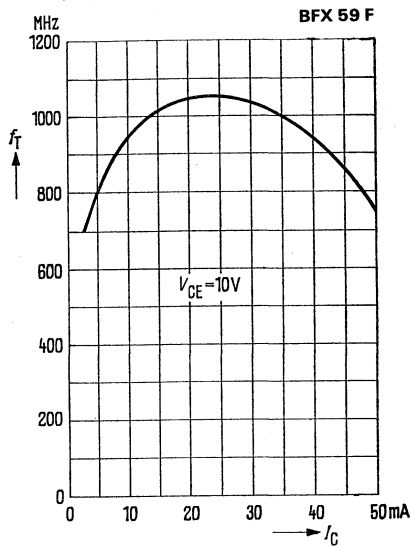

Not for new design

BFX 60 is an epitaxial NPN silicon planar RF transistor in TO 72 case (18 A 4 DIN 41 876), however, with different lead arrangement. The leads are electrically insulated from the case. The transistor is particularly suitable for RF amplifier stages in common emitter configuration.

Type	Ordering code
BFX 60	Q60206-X60

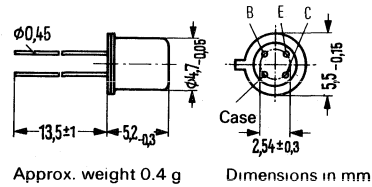

Maximum ratings

Collector-base voltage	V_{CB0}	40	V
Collector-emitter voltage	V_{CE0}	25	V
Emitter-base voltage	V_{EB0}	4	V
Collector current	I_C	25	mA
Junction temperature	T_j	200	°C
Storage temperature range	T_{stg}	-65 to +175	°C
Total power dissipation ($T_{case} \leq 70 \text{ °C}$)	P_{tot}	370	mW

Thermal resistance

Junction to ambient air	R_{thJA}	≤ 650	K/W
Junction to case	R_{thJC}	≤ 350	K/W

Static characteristics ($T_{amb} = 25^{\circ}\text{C}$)

DC current gain ($I_C = 7\text{ mA}; V_{CE} = 10\text{ V}$)
 Base-emitter voltage ($I_C = 7\text{ mA}; V_{CE} = 10\text{ V}$)
 Base current $V_{CB} = 2\text{ V}; -I_E = 20\text{ mA}$
 Collector cutoff current ($V_{CBS} = 40\text{ V}$)
 Collector-emitter breakdown voltage
 ($I_{CEO} = 2\text{ mA}$)
 Emitter-base breakdown voltage
 ($I_{EBO} = 1\text{ }\mu\text{A}$)

h_{FE}	100 (>50)	-
V_{BE}	0.74 (<0.9)	V
I_B	<1.3	mA
I_{CBS}	<100	nA
$V_{(BR)CEO}$	>25	V
$V_{(BR)EBO}$	>4	V

Dynamic characteristics ($T_{amb} = 25^{\circ}\text{C}$)

Transition frequency
 ($V_{CE} = 10\text{ V}; I_C = 5\text{ mA}; f = 100\text{ MHz}$)
 Reverse transfer capacitance
 ($V_{CE} = 10\text{ V}; I_C = 1\text{ mA}; f = 1\text{ MHz}$)
 Noise figure
 ($I_C = 2\text{ mA}; V_{CE} = 10\text{ V}; f = 200\text{ MHz}; R_g = 60\text{ }\Omega$)

f_T	550 (>400)	MHz
C_{12e}	0.26 (<0.3)	pF
NF	5	dB

Forward transfer admittance y_{21e}

at	$I_C = 2\text{ mA}; V_{CE} = 10\text{ V}$	$I_C = 7\text{ mA}; V_{CE} = 10\text{ V}$
$f = 35\text{ MHz}$	$y_{21e} = 67\text{ mS}; \varphi_{21e} = -10^{\circ}$	$y_{21e} = 140\text{ mS}; \varphi_{21e} = -30^{\circ}$
$f = 100\text{ MHz}$	$y_{21e} = 63\text{ mS}; \varphi_{21e} = -37^{\circ}$	$y_{21e} = 100\text{ mS}; \varphi_{21e} = -60^{\circ}$
$f = 200\text{ MHz}$	$y_{21e} = 60\text{ mS}; \varphi_{21e} = -60^{\circ}$	$y_{21e} = 80\text{ mS}; \varphi_{21e} = -90^{\circ}$

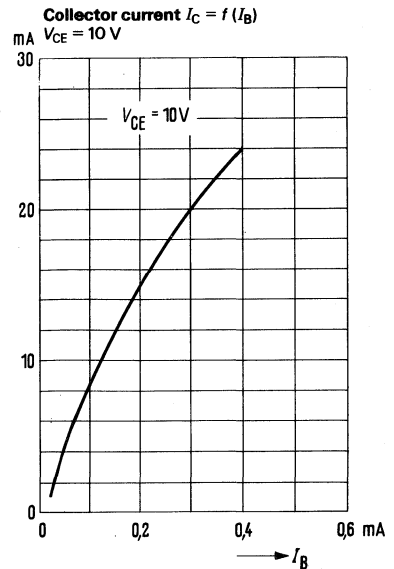
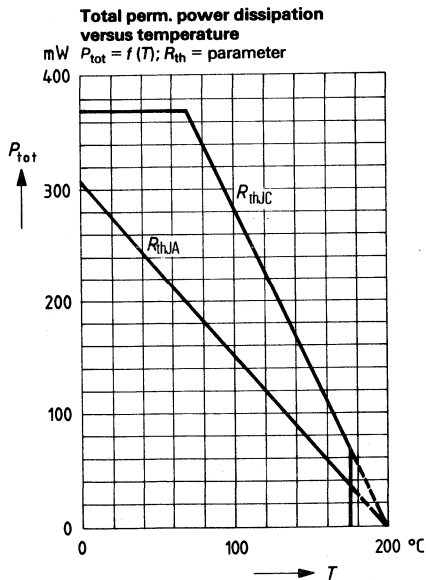

Input characteristic $I_B = f(V_{BE})$
 $V_{CE} = 10\text{ V}$

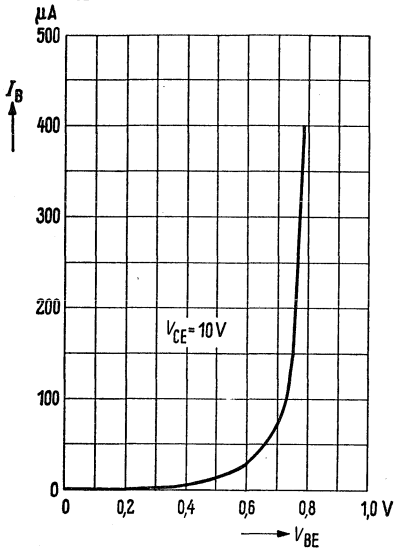

Output characteristics $I_C = f(V_{CE})$
 $I_B = \text{parameter}$
 (common emitter configuration)

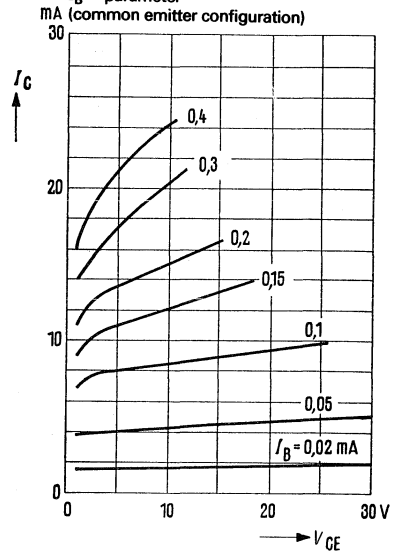

Output characteristics $I_C = f(V_{CE})$
 $I_B = \text{parameter}$
 (common emitter configuration)

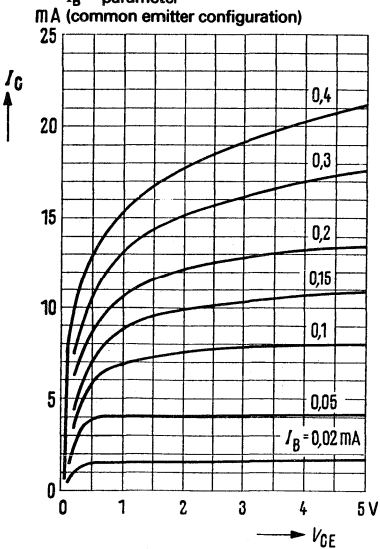

Collector-emitter breakdown voltage
 $V_{(BR)CER} = f(R_B)$
 Cutoff characteristic $I_C = 2\text{ mA}$; $R_E \leq 1\text{ k}\Omega$

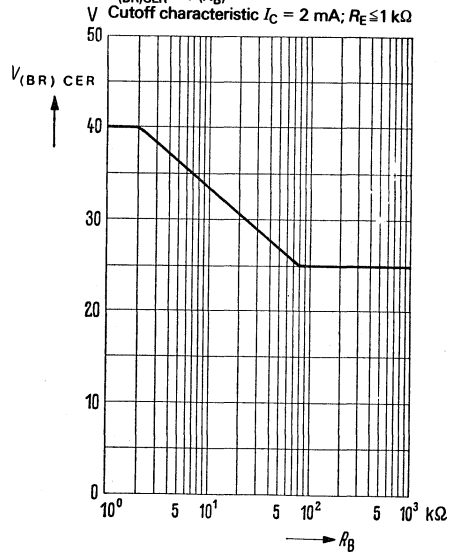

BFX 89 is an epitaxial NPN silicon RF transistor in TO 72 case (18 A 4 DIN 41876). The leads are electrically insulated from the case. This transistor is suitable for general applications up to the GHz range, e.g. for use in antenna and RF amplifiers.

Type	Ordering code
BFX 89	Q62702-F296

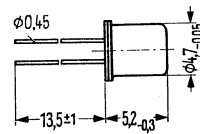

Approx. weight 0.4 g

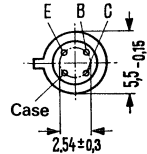

Dimensions in mm

Maximum ratings

Collector-base voltage
 Collector-emitter voltage ($R_{BE} \leq 50 \Omega$)
 Collector-emitter voltage
 Emitter-base voltage
 Collector current
 Collector peak current ($t < 1 \mu s$)
 Junction temperature
 Storage temperature range
 Total power dissipation ($T_{amb} \leq 60^\circ C$)

V_{CBO}	30	V
V_{CER}	30	V
V_{CEO}	15	V
V_{EBO}	2.5	V
I_C	25	mA
I_{CM}	50	mA
T_j	200	$^\circ C$
T_{stg}	-65 to +175	$^\circ C$
P_{tot}	200	mW

Thermal resistance

Junction to ambient air
 Junction to case

R_{thJA}	≤ 700	K/W
R_{thJC}	≤ 400	K/W

Static characteristics ($T_{amb} = 25^{\circ}\text{C}$)

Collector cutoff current ($V_{CBO} = 15\text{ V}$)

Collector-emitter saturation voltage

($I_C = 20\text{ mA}$)

DC current gain

($I_C = 2\text{ mA}$; $V_{CE} = 1\text{ V}$)

($I_C = 25\text{ mA}$; $V_{CE} = 1\text{ V}$)

I_{CBO}	≤ 10	nA
V_{CEsat}	≤ 0.75	V
h_{FE}	20 to 150	-
h_{FE}	20 to 125	-

Dynamic characteristics ($T_{amb} = 25^{\circ}\text{C}$)

Transition frequency

($I_C = 2\text{ mA}$; $V_{CE} = 5\text{ V}$; $f = 200\text{ MHz}$)

Reverse transfer capacitance

($I_C = 2\text{ mA}$; $V_{CE} = 5\text{ V}$; $f = 1\text{ MHz}$)

Collector-base capacitance

($V_{CB} = 10\text{ V}$; $I_E = 0$; $f = 1\text{ MHz}$)

Noise figure ($I_C = 2\text{ mA}$; $V_{CE} = 5\text{ V}$)

($f = 200\text{ MHz}$; $R_g = 100\ \Omega$)

($f = 500\text{ MHz}$; $R_g = 60\ \Omega$)

($f = 800\text{ MHz}$; $R_g = 60\ \Omega$)

Power gain

($I_C = 14\text{ mA}$, $V_{CE} = 10\text{ V}$; $f = 200\text{ MHz}$; $R_g = 60\ \Omega$)

Output voltage¹⁾

($I_C = 14\text{ mA}$; $V_{CE} = 5\text{ V}$; $R_L = 75\ \Omega$; $d_{IM} = 60\text{ dB}$)

f_T	1.2	GHz
C_{12e}	0.7	pF
C_{CBO}	≤ 1.2	pF
NF	3 (≤ 4)	dB
NF	≤ 6.5	dB
NF	7	dB
G_{pe}	23	dB
V_O	150	mV

1) Measured with three tone modulation f approx. 800 MHz

S parameter

Operating point: $I_C = 12 \text{ mA}$; $V_{CE} = 5 \text{ V}$; $Z_o = 50 \Omega$

f (GHz)	S_{11}	φ	S_{21}	φ	S_{12e}	φ	S_{22e}	φ	G_{\max} (dB)
0,2	0,258	- 78	7,249	107	0,058	76	0,592	-14	19,38
0,3	0,160	-100	5,095	97	0,080	80	0,529	-12	15,68
0,4	0,132	-122	3,918	90	0,104	83	0,514	-10	13,27
0,5	0,130	-140	3,229	86	0,125	86	0,465	- 9	11,31
0,6	0,143	-151	2,788	83	0,149	88	0,463	-12	10,04
0,7	0,150	-155	2,410	80	0,171	89	0,455	-13	8,75
0,8	0,160	-159	2,137	76	0,190	90	0,456	-15	7,72
0,9	0,160	-158	2,009	73	0,214	90	0,467	-17	7,24
1,0	0,152	-157	1,837	71	0,233	91	0,473	-20	6,48
1,1	0,136	-153	1,684	69	0,252	92	0,508	-21	5,90
1,2	0,117	-146	1,573	66	0,269	93	0,522	-22	5,38
1,3	0,092	-135	1,466	63	0,275	94	0,563	-24	5,02
1,4	0,074	-114	1,371	60	0,287	93	0,595	-25	4,66
1,5	0,070	- 89	1,267	56	0,298	92	0,637	-26	4,34

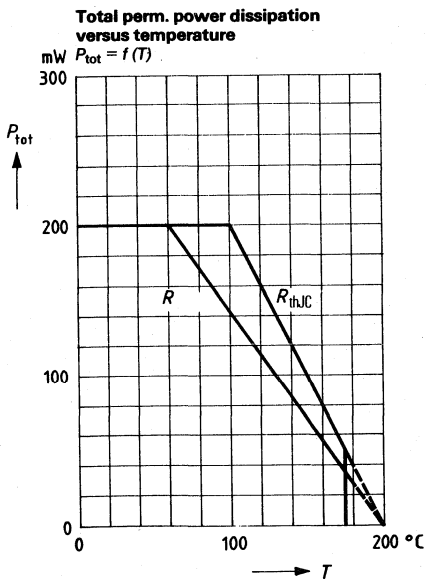

BFY 90 is an epitaxial NPN silicon planar RF transistor in TO 72 case (18 A 4 DIN 41 876). The leads are electrically insulated from the case. This transistor is suitable for general applications up to the GHz range, e.g. in antenna and RF amplifiers.

Type	Ordering code
BFY 90	Q62702-F297

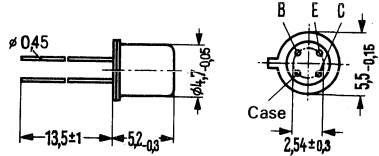

Approx. weight 0.4 g

Dimensions in mm

Maximum ratings

- Collector-base voltage
- Collector-emitter voltage ($R_{BE} \leq 50 \Omega$)
- Collector-emitter voltage
- Emitter-base voltage
- Collector current
- Collector peak current ($t < 1 \mu s$)
- Junction temperature
- Storage temperature range
- Total power dissipation ($T_{amb} \leq 60^\circ C$)

V_{CBO}	30	V
V_{CER}	30	V
V_{CEO}	15	V
V_{EBO}	2.5	V
I_C	25	mA
I_{CM}	50	mA
T_j	200	$^\circ C$
T_{stg}	-65 to +175	$^\circ C$
P_{tot}	200	mW

Thermal resistance

Junction to ambient air	R_{thJA}	≤ 700	K/W
Junction to case	R_{thJC}	≤ 400	K/W

Static characteristics ($T_{amb} = 25^{\circ}\text{C}$)

Collector cutoff current ($V_{CB0} = 15\text{ V}$; $I_E = 0$)	I_{CB0}	≤ 10	nA
DC current gain ($I_C = 2\text{ mA}$; $V_{CE} = 1\text{ V}$)	h_{FE}	20 to 150	–
($I_C = 25\text{ mA}$; $V_{CE} = 1\text{ V}$)	h_{FE}	20 to 125	–
Collector-emitter saturation voltage ¹⁾ ($I_C = 20\text{ mA}$)	V_{CEsat}	≤ 0.75	V

Dynamic characteristics ($T_{amb} = 25^{\circ}\text{C}$)

Transition frequency ($I_C = 2\text{ mA}$; $V_{CE} = 5\text{ V}$; $f = 200\text{ MHz}$)	f_T	≥ 1.2	GHz
Reverse transfer capacitance ($I_C = 2\text{ mA}$; $V_{CE} = 5\text{ V}$; $f = 1\text{ MHz}$)	C_{12e}	$0.6 (\leq 0.8)$	pF
Collector-base capacitance ($V_{CB} = 10\text{ V}$; $I_E = 0$; $f = 1\text{ MHz}$)	C_{CB0}	≤ 1.5	pF
Noise figure ($I_C = 2\text{ mA}$; $V_{CE} = 5\text{ V}$)			
($f = 100\text{ kHz}$; $R_g = R_{g\text{ opt}}$)	NF	≤ 4	dB
($f = 200\text{ MHz}$; $R_g = R_{g\text{ opt}}$)	NF	$2.5 (\leq 3.5)$	dB
($f = 500\text{ MHz}$; $R_g = 50\ \Omega$)	NF	≤ 5	dB
($f = 800\text{ MHz}$; $R_g = 50\ \Omega$)	NF	$5.5 (\leq 6.5)$	dB
Power gain ($I_C = 14\text{ mA}$; $V_{CE} = 10\text{ V}$; $f = 200\text{ MHz}$; $R_g = 60\ \Omega$)	G_{pe}	23	dB
Output voltage ²⁾	V_O	150	mV
($I_C = 14\text{ mA}$; $V_{CE} = 5\text{ V}$; $R_g = R_L = 75\ \Omega$; $d_{IM} = 60\text{ dB}$)			

1) Applicable to that characteristic passing through point $I_C = 22\text{ mA}$; $V_{CE} = 1\text{ V}$ at constant I_B

2) Measured with three tone modulation f approx. 800 MHz

S parameter

Operating point: $V_{CE} = 5 \text{ V}$; $I_C = 12 \text{ mA}$; $Z_o = 50 \Omega$

f (GHz)	S_{11e}	φ	S_{21}	φ	S_{12e}	φ	S_{22e}	φ	G_{max} (dB)
0,2	0,252	- 77	7,354	107	0,056	77	0,596	-13	19,52
0,3	0,156	- 97	5,142	97	0,078	81	0,535	-12	15,79
0,4	0,127	-119	3,970	91	0,102	85	0,524	- 9	13,44
0,5	0,125	-136	3,287	86	0,123	87	0,483	- 9	11,56
0,6	0,136	-147	2,821	83	0,146	88	0,477	-11	10,21
0,7	0,144	-152	2,434	81	0,168	90	0,469	-13	8,90
0,8	0,155	-156	2,155	76	0,187	91	0,472	-15	7,87
0,9	0,156	-155	2,026	74	0,210	91	0,483	-17	7,39
1,0	0,149	-153	1,850	72	0,229	93	0,490	-20	6,63
1,1	0,135	-148	1,692	70	0,249	94	0,525	-21	6,05
1,2	0,117	-141	1,578	68	0,267	96	0,537	-21	5,50
1,3	0,095	-130	1,468	65	0,273	96	0,575	-23	5,12
1,4	0,077	-111	1,373	62	0,286	95	0,608	-24	4,78
1,5	0,072	- 87	1,275	58	0,300	95	0,644	-25	4,46

Total perm. power dissipation versus temperature

mW $P_{tot} = f(T)$; R_{th1} = parameter

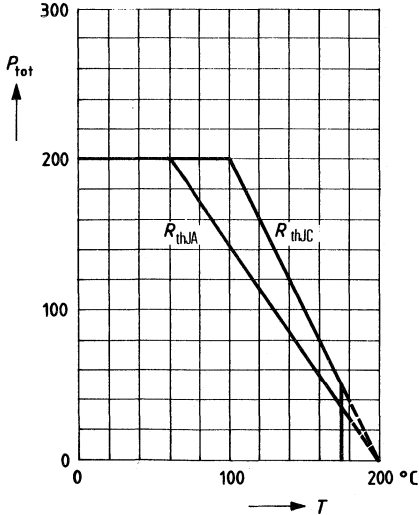

BR 103 is a silicon planar thyristor in a TO-92 plastic package (10 A 3 DIN 41868). This thyristor is suitable for various applications within low power ranges, e.g. controls and regulations, counters, switches, etc.

Type	Ordering code
BR 103	Q68000-A729

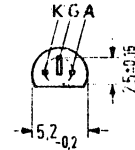
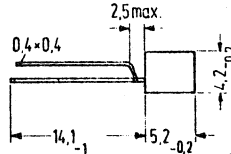

Mounting instruction.
 Fixing hole: 0.6 mm dia.
 Approx. weight 0.25 g

Dimensions in mm

Maximum ratings ($T_j = -40^\circ\text{C}$ to $+125^\circ\text{C}$; $R_{GK} = 1000 \Omega$)

Neg. and pos. repetitive peak off-state voltage	V_{RR}/V_{DR}	30	V
Max. rms on-state current	$I_{T(rms)}$	0.8	A
Surge on-state current, sinusoidal pulse ($t_p < 10$ ms)	I_{TSM}	6	A
Repetitive surge on-state current at $t_p = 6 \mu\text{s}$ and $f = 40$ kHz sine	I_T	2	A
Peak gate forward current	I_{GFP}	0.5	A
Repetitive reverse gate voltage	$V_{(KG)R}$	6	V
Storage temperature range	T_{stg}	-40 to +125	$^\circ\text{C}$
Junction temperature range	T_j	-40 to +125	$^\circ\text{C}$
Average gate power dissipation	$P_{G(AV)}$	0.01	W
Peak gate power dissipation	P_{GP}	0.1	W

Static characteristics ($T_{\text{case}} = 25^\circ\text{C}$)

Continuous reverse blocking and off-state current ($R_{\text{GK}} = 1 \text{ k}\Omega$) ($T_j = 125^\circ\text{C}$)	$I_{\text{R}}/I_{\text{D}}$	<2	μA
Holding current ($R_{\text{GK}} = 1 \text{ k}\Omega$) ($T_j = -40^\circ\text{C}$)	$I_{\text{R}}/I_{\text{D}}$	<50	μA
On-state voltage ($I_{\text{TS}} = 1 \text{ A}$; $t_{\text{p}} = 1 \text{ ms}$)	I_{H}	<3	mA
Gate trigger current ($V_{\text{AK}} = 6\text{V}$; $R_{\text{L}} = 100 \Omega$) ($T_j = 0^\circ\text{C}$)	I_{H}	<4	mA
Gate trigger voltage ($V_{\text{AK}} = 6\text{V}$, $R_{\text{L}} = 100 \Omega$, $R_{\text{GT}} = 1 \text{ k}\Omega$, $T_j = 0^\circ\text{C}$)	V_{T}	<1.5	V
Gate non-trigger forward voltage ($V_{\text{D}} = V_{\text{DR}}$; $R_{\text{GK}} = 1 \text{ k}\Omega$; $T_j = 125^\circ\text{C}$)	I_{GT}	<200	μA
Critical rate of voltage rise ($R_{\text{GK}} = 1 \text{ k}\Omega$; $T_j = 125^\circ\text{C}$; $V_{\text{AK}} = 10 \text{ V}$)	I_{GT}	<250	μA
Turn-off time ($I_{\text{TS}}(\text{rectangular}) = 1 \text{ A}$; $t_{\text{p}} = 50 \mu\text{s}$; $V_{\text{R}} = 20 \text{ V}$; $V_{\text{AK}} = V_{\text{DR}}$; $T_{\text{dV/dt}} = 5 \mu\text{s}$)	V_{GT}	<0.8	V
Turn-on time ($V_{\text{D}} = V_{\text{DR}}$; $R_{\text{L}} = 100 \Omega$; $R_{\text{GK}} = 1 \text{ k}\Omega$; $I_{\text{GTS}} = 1.4 \text{ mA}$, $t_{\text{p}} = 5 \mu\text{s}$; $t_{\text{r}} = 40 \text{ ns}$)	V_{GT}	<0.9	V
	V_{GF}	>0.1	V
	dv/dt	10	$\text{V}/\mu\text{s}$
	t_{q}	<6	μs
	t_{on}	1.2	μs

Max. mean on-state current

(sine) $I_{TAV} = f(T_{amb})$
 $f = 50$ to 400 Hz

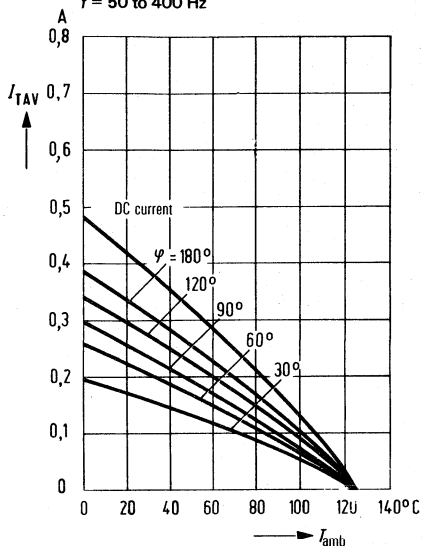

On-state characteristic

(short-time power); $I_{TS} = f(V_T)$

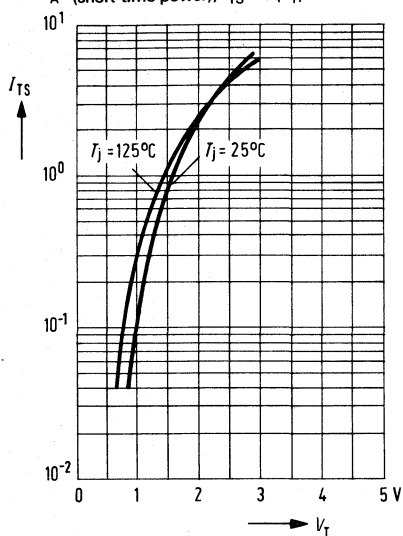

Max. mean on-state current

(sine) $I_{TAV} = f(T_{case})$
 $f = 50$ to 400 Hz

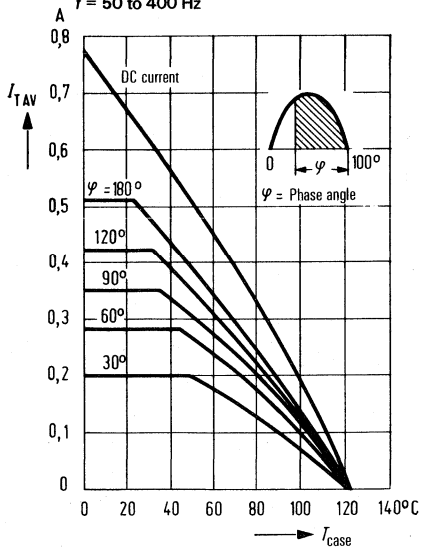

Power dissipation (sine) $P_{tot} = f(I_{TAV})$

$f = 50$ to 400 Hz; $T = 125^\circ\text{C}$

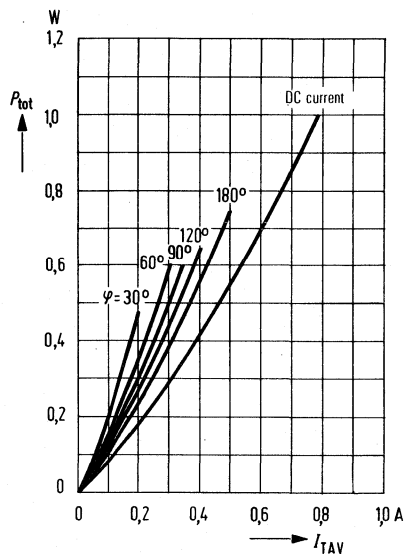

Surge on-state current
 $I_{TS} = f(\text{overloads at 50 Hz})$

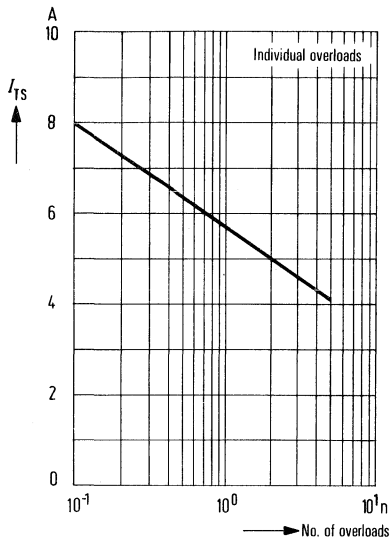

BR 303 is a silicon planar thyristor in a TO-126 plastic package (12 A 3 DIN 41 869, sheet 4). The thyristor is especially suitable for use in switching power supplies as well as for universal applications at low and medium performance.

Type	Ordering code
BR 303	Q68000-A3436

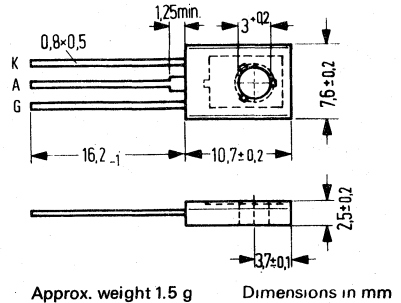

Maximum ratings ($T_j = -40\text{ }^\circ\text{C}$ to $+125\text{ }^\circ\text{C}$, $R_{GK} = 1000\ \Omega$)

Neg. and pos. repetitive
peak off-state voltage

V_{RR}/V_{DR}	30	V
-----------------	----	---

Max. rms on-state current

$I_{T(rms)}$	0.8	A
--------------	-----	---

Surge on-state current
(sinusoidal pulse $t_r < 1\text{ ms}$
in accordance with DIN 41 787)

I_{TSM}	6	A
-----------	---	---

Repetitive peak current
($t_p = 5\ \mu\text{s}$, $v \leq 0.1$)

I_{TRM}	4	A
-----------	---	---

Repetitive gate voltage

$V_{(KG)rep}$	8	V
---------------	---	---

Storage temperature range

T_{stg}	$-55\text{ to }+125$	$^\circ\text{C}$
-----------	----------------------	------------------

Junction temperature

T_j	125	$^\circ\text{C}$
-------	-----	------------------

Average gate power dissipation

$P_{G(AV)}$	0.1	W
-------------	-----	---

Peak gate power dissipation

P_{GP}	2	W
----------	---	---

Thermal resistance

Junction to ambient air

R_{thJA}	≤ 125	K/W
------------	------------	-----

Junction to case

R_{thJC}	≤ 25	K/W
------------	-----------	-----

Static characteristics ($T_{\text{case}} = 25^\circ\text{C}$)

Continuous reverse blocking and off-state current

($R_{\text{GK}} = 1 \text{ k}\Omega$)	$I_{\text{R}}/I_{\text{D}}$	≤ 2	μA
($R_{\text{GK}} = 1 \text{ k}\Omega$; $T_{\text{j}} = 125^\circ\text{C}$)	$I_{\text{R}}/I_{\text{D}}$	≤ 50	μA
Holding current ($R_{\text{GK}} = 1 \text{ k}\Omega$)	I_{H}	< 5	mA
Neg. gate current ($t_{\text{p}} = 10 \mu\text{s}$)	$-I_{\text{G}}$	0.05	mA
On-state voltage, pulsed ($I_{\text{T}} = 3 \text{ A}$; $t_{\text{p}} = 5 \mu\text{s}$)	V_{T}	≤ 2.0	V
Gate trigger current ($V_{\text{AK}} = 6 \text{ V}$; $R_{\text{L}} = 100 \Omega$)	I_{GT}	≤ 200	μA
Gate trigger voltage ($V_{\text{AK}} = 6 \text{ V}$; $R_{\text{L}} = 100 \Omega$; $R_{\text{GK}} = 1 \Omega$)	V_{GT}	≤ 0.8	V
Gate non-trigger forward voltage ($V_{\text{D}} = V_{\text{DR}}$, $R_{\text{GK}} = 1 \text{ k}\Omega$)	V_{GF}	≥ 0.1	V
Critical rate of voltage rise ($R_{\text{GK}} = 1 \text{ k}\Omega$; $V_{\text{AK}} = 20 \text{ V}$).	dv/dt	20	$\text{V}/\mu\text{s}$
Turn-off time ($I_{\text{TS(rectangular)}} = 0.8 \text{ A}$, $t_{\text{p}} = 50 \mu\text{s}$; $V_{\text{R}} = 20 \text{ V}$; $V_{\text{AK}} = V_{\text{DR}}$; $dv/dt = 20 \text{ V}/\mu\text{s}$)	t_{q}	≤ 13	μs
Turn-on time ($V_{\text{D}} = V_{\text{DR}}$; $R_{\text{L}} = 100 \Omega$; $R_{\text{GK}} = 1 \text{ k}\Omega$; $I_{\text{GTS}} = 1.4 \text{ mA}$; $t_{\text{p}} = 5 \mu\text{s}$; $t_{\text{r}} = 40 \text{ ns}$)	t_{cn}	1.2	μs

BR 403 is a silicon planar thyristor in a plastic package similar to TO 202. The thyristor is especially suitable for use in switching power supplies as well as for universal applications at low and medium performance.

Type	Ordering code
BR 403	Q62702-R306

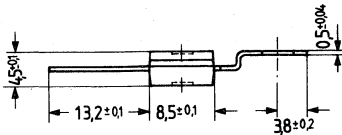

Available upon request also with bent fixing plate

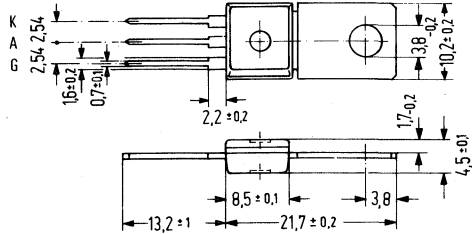

Approx. weight 15 g

Dimensions in mm

Maximum ratings ($T_j = -40$ to $+125$ °C, $R_{GK} = 1000$ Ω)

Neg. and pos. repetitive peak off-state voltage

V_{RR}/V_{DR}	30	V
$I_{T(rms)}$	0.8	A

Max. rms on-state current

Surge on-state current (sinusoidal pulse $t_p < 1$ ms in accordance with DIN 41787)

I_{TSM}	6	A
-----------	---	---

Repetitive peak current ($t_p = 5$ μs, $v \leq 0.1$)

I_{TRM}	4	A
-----------	---	---

Repetitive gate voltage

$V_{(KG)rep}$	8	V
---------------	---	---

Average gate power dissipation

$P_{G(AV)}$	0.1	W
-------------	-----	---

Peak gate power dissipation

P_{GP}	2	W
----------	---	---

Storage temperature range

T_{stg}	-55 to +125	°C
-----------	-------------	----

Junction temperature

T_j	125	°C
-------	-----	----

Thermal resistance

Junction to ambient air

R_{thJA}	≤ 80	K/W
------------	-----------	-----

Junction to case

R_{thJC}	≤ 30	K/W
------------	-----------	-----

Static characteristics ($T_G = 25^\circ\text{C}$)

Continuous reverse blocking and off-state current

($R_{GK} = 1\text{ k}\Omega$)	I_R/I_D	≤ 2	μA
($R_{GK} = 1\text{ k}\Omega$; $T_j = 125^\circ\text{C}$)	I_R/I_D	≤ 50	μA
Holding current ($R_{GK} = 1\text{ k}\Omega$)	I_H	< 5	mA
Neg gate current ($t_p = 10\text{ }\mu\text{s}$)	$-I_G$	0.05	mA
On-state voltage, pulsed ($I_T = 3\text{ A}$; $t_p = 5\text{ }\mu\text{s}$)	V_T	≤ 2.0	V
Gate trigger current ($V_{AK} = 6\text{ V}$; $R_L = 100\text{ }\Omega$)	I_{GT}	≤ 200	μA
Gate trigger voltage ($V_{AK} = 6\text{ V}$; $R_L = 100\text{ }\Omega$; $R_{GK} = 1\text{ k}\Omega$)	V_{GT}	≤ 0.8	V
Gate non-trigger forward voltage ($V_D = V_{DR}$ $R_{GK} = 1\text{ k}\Omega$)	V_{GF}	≥ 0.1	V
Critical rate of voltage rise ($R_{GK} = 1\text{ k}\Omega$, $V_{AK} = 20\text{ V}$)	dv/dt	20	$\text{V}/\mu\text{s}$
Turn-off time ($I_{TS(\text{rectangular})} = 0.8\text{ A}$; $t_p = 50\text{ }\mu\text{s}$; $V_R = 20\text{ V}$; $V_{AK} = V_{DR}$; $dv/dt = 20\text{ V}/\mu\text{s}$)	t_q	≤ 13	μs
Turn-on time ($V_D = V_{DR}$; $R_L = 100\text{ }\Omega$; $R_{GK} = 1\text{ k}\Omega$) $I_{GTS} = 1.4\text{ mA}$; $t_p = 5\text{ }\mu\text{s}$; $t_r = 40\text{ ns}$)	t_{on}	1.2	μs

BRY 20 is an extinguishable PNPN silicon planar thyristortetrode in TO 12 case (5 C 4 DIN 41 873). The anode gate (G_A) is electrically connected to the case. The BRY 20 is particularly suitable for use as a medium fast switch.

Type	Ordering code
BRY 20	Q60217-Y20

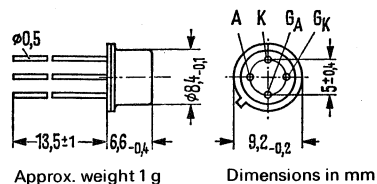

Maximum ratings

Anode gate reverse voltage	V_{GAR}	40	V
Continuous reverse voltage	$-V_R$	40	V
Gate to cathode reverse voltage	V_{GKR}	5	V
Rated surge forward current, see diagram $I_{FRM} = f(t) I_{FSM}$	I_{FSM}	5	A
Continuous forward current	I_F	500	mA
Gate to cathode control current	I_{GK}	100	mA
Anode to gate control current	I_{GA}	300	mA
Junction temperature range	T_j	-55 to +125	°C
Storage temperature range	T_{stg}	-55 to +200	°C
Total power dissipation ($T_{case} \leq 45^\circ\text{C}$)	P_{tot}	1.3	W

Thermal resistance

Junction to ambient air	R_{thJA}	≤ 220	K/W
Junction to case	R_{thJC}	≤ 60	K/W

Static characteristics ($T_{amb} = 25^\circ\text{C}$)

Off-state current			
($V_D = 40\text{ V}$; $R_{GK} = 5\text{ k}\Omega$; $I_{GA} = 0$)	I_D	3 (< 200)	nA
($V_D = 30\text{ V}$; $R_{GK} = 5\text{ k}\Omega$; $I_{GA} = 0$)	I_D	2 (< 200)	nA
Reverse current			
($V_R = 40\text{ V}$; $R_{GK} = 5\text{ k}\Omega$; $I_{GA} = 0$)	I_R	< 200	nA
($V_R = 40\text{ V}$; $R_{GK} = 5\text{ k}\Omega$; $T_{amb} = 125^\circ\text{C}$)	I_R	< 25	μA
Cathode-gate reverse current			
($V_{GK} = 5\text{ V}$; $I_{AK} = 0$)	$-I_{GKR}$	< 10	μA
Anode-gate reverse current			
$V_{GA} = 40\text{ V}$	I_{GAR}	< 200	nA
Forward voltage			
($I_F = 100\text{ mA}$; $R_{GK} = 5\text{ k}\Omega$; $I_{GA} = 0$)	V_F	< 1.3	V
Breakover voltage (-55 to +125°C)			
($R_{GK} = 5\text{ k}\Omega$; $I_{GA} = 0$)	$V_{(BO)}$	< 40	V
Holding current ($R_{GK} = 5\text{ k}\Omega$)	I_H	2 (0.3 to 6.5)	mA ¹⁾

1) Closer tolerance available on request

Operating point: $V_{batt} = 15\text{ V}$; $R_L = 1\text{ k}\Omega$; $I_{GA} = 0$

Gate trigger current

Turn-off current

Gate trigger voltage

Operating point: $V_{batt} = 15\text{ V}$; $R_L = 500\ \Omega$; $G_A I_G = 0$

Gate trigger current

Turn-off current

Operating point: $V_{batt} = 15\text{ V}$; $R_L = 0.5\text{ k}\Omega$;

$R_{GK} = 5\text{ k}\Omega$

Anode gate trigger current

Anode gate trigger voltage

I_{GKT}	50 (<100)	μA
I_{GKQ}	2.5 (<5)	mA
V_{GKT}	0.4 (to 0.8)	V
I_{GKT}	50 (<100)	μA
I_{GKQ}	10 (<15)	mA
I_{GAT}	<3	mA
V_{GAT}	0.4 to 0.8	V

Dynamic characteristics

Operating point: $V_{batt} = 15\text{ V}$; $R_L = 1\text{ k}\Omega$;

$R_{GK} = 5\text{ k}\Omega$; $I_{GKT} = I_{GKQ} = 5\text{ mA}$

Gate controlled turn-on time

Gate controlled turn-off time

Junction capacitance ($V_{AK} = 20\text{ V}$)

Turn-off time ($V_{AA} = 15\text{ V}$; $R_L = 1\text{ k}\Omega$; $R_{AK} = 5\text{ k}\Omega$)

Critical rate of voltage rise¹⁾

($V_{AA} = 40\text{ V}$; $R_{GK} = 100\text{ k}\Omega$)

t_g	100 (<300)	ns
t_{gq}	<5	μs
C_{AK}	3.5	pF
t_q	7	μs
du/dt	>5	V/ μs

Test circuit for switching times

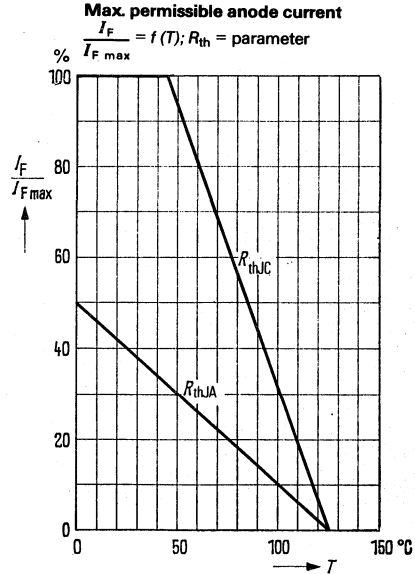
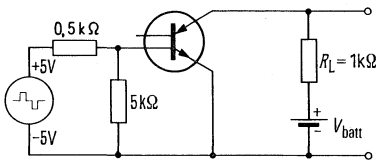

1) If the anode gate is connected to the anode supply voltage via a 220 kΩ resistor, the permissible voltage rise at the anode is unlimited.

Permissible anode current versus pulse width and duty cycle
 $I_{FRM} = f(t); v = \text{parameter}$

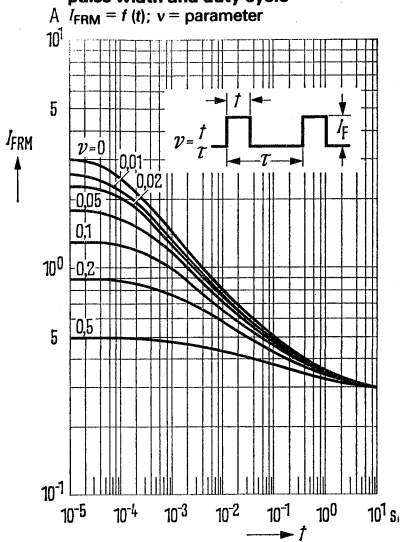

Switching ratio $I_A/I_{GKQ} = f(I_A)$

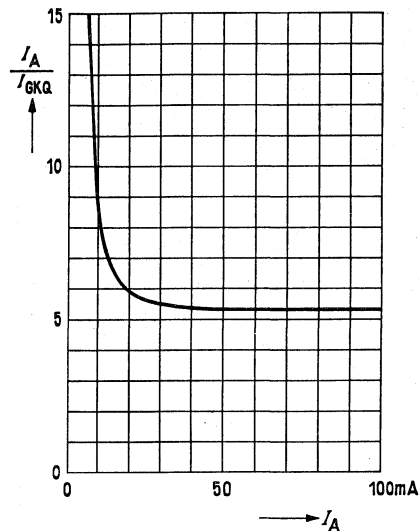

Anode current $I_A = f(T_{amb})$
 Average values and scattering limits

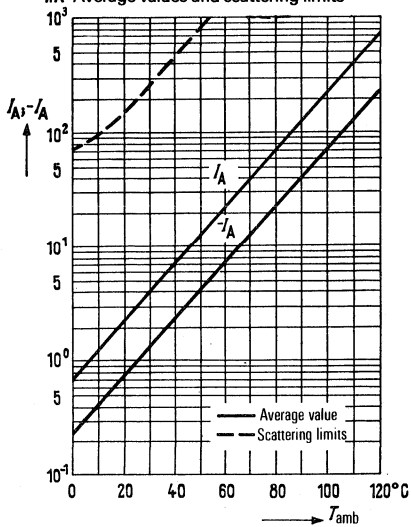

Forward voltage $V_F = f(T_{amb})$
 Forward current $I_F = \text{parameter}$

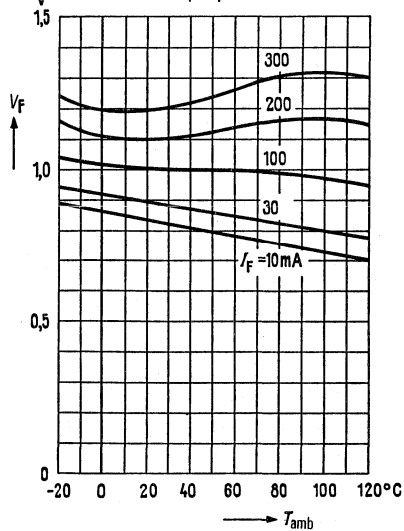

Trigger current $I_{GKT} = f(T_{amb})$
Trigger voltage $V_{GKT} = f(T_{amb})$
 $V_{batt} = 15\text{ V}; R_L = 1\text{ k}\Omega$

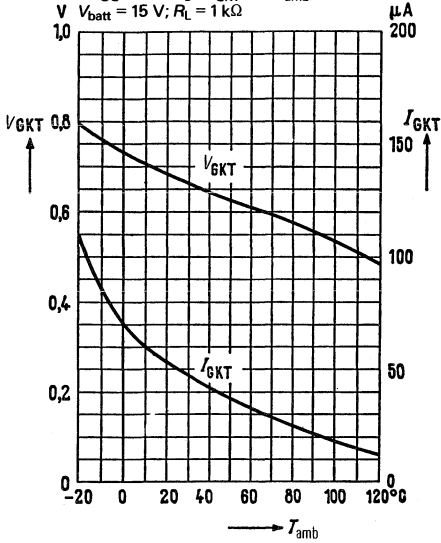

Anode control current $I_{GAT} = f(T_{amb})$
 $R_{GK} = \text{parameter}$
 $V_{batt} = 15\text{ V}; R_L = 1\text{ k}\Omega$

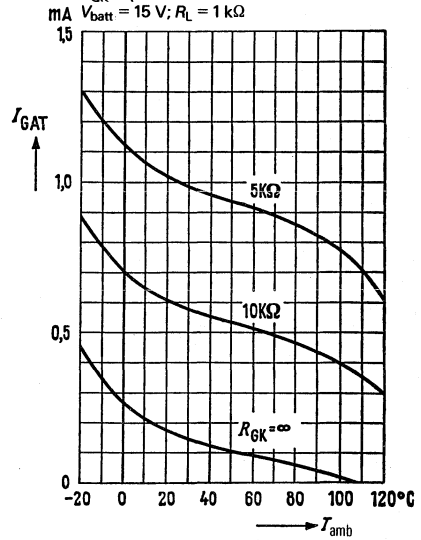

Turn-off current $I_{GKQ} = f(T_{amb})$
 $I_F = \text{parameter}$

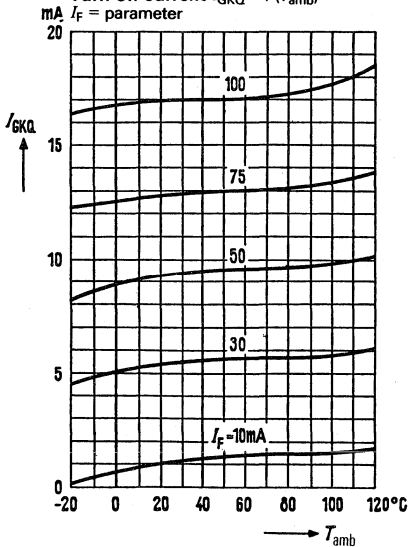

Holding current $I_{AH} = f(T_{amb})$
 Average values scattering limits
 $R_{GK} = 5\text{ k}\Omega$

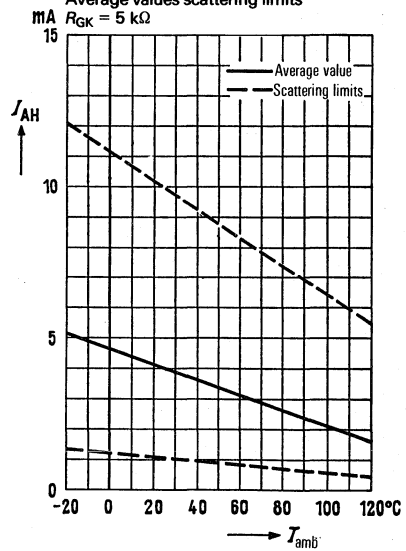

The BRY 21 is an extinguishable PNPN silicon planar thyristortetrode in TO 12 case (5 C 4 DIN 41 873). The anode gate (G_A) is electrically connected to the case. The BRY 21 is particularly suitable for use as a medium fast switch.

Type	Ordering code
BRY 21	Q62702-R81

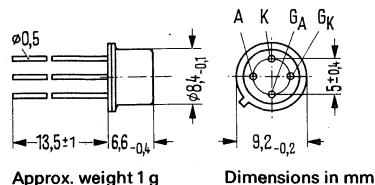

Maximum ratings

Anode gate reverse voltage	V_{GAR}	80	V
Continuous reverse voltage	$-V_R$	80	V
Gate to cathode reverse voltage	V_{GKR}	5	V
Forward current ¹⁾	I_F	500	mA
Peak current	I_{FSM}	5	A
Gate to cathode control current	I_{GK}	100	mA
Anode to gate control current	I_{GA}	300	mA
Junction temperature range	T_j	-55 to +125	°C
Storage temperature range	T_{stg}	-55 to +200	°C
Total power dissipation ($T_{case} \leq 45^\circ C$)	P_{tot}	1.3	W

Thermal resistance

Junction to case	R_{thJC}	≤ 60	K/W
Junction to ambient air	R_{thJA}	≤ 220	K/W

Static characteristics ($T_{amb} = 25^\circ C$)

Breakover voltage ($R_{GK} = 5\text{ k}\Omega$; $T_{amb} \leq 125^\circ C$)	$V_{(BO)}$	80	V
Off-state current ($V_D = 80\text{ V}$; $R_{GK} = 5\text{ k}\Omega$; $T_{amb} = 25^\circ C$)	I_D	< 200	nA
($V_D = 80\text{ V}$; $R_{GK} = 5\text{ k}\Omega$; $T_{amb} = 125^\circ C$)	I_D	< 25	μA
Reverse current ($V_R = 80\text{ V}$; $R_{GK} = 5\text{ k}\Omega$; $T_{amb} = 25^\circ C$)	I_R	< 200	nA
($V_R = 80\text{ V}$; $R_{GK} = 5\text{ k}\Omega$; $T_{amb} = 125^\circ C$)	I_R	< 25	μA
Cathode-gate reverse current ($V_{GKR} = 5\text{ V}$; $T_{amb} = 25^\circ C$)	$-I_{GKR}$	< 10	μA
Anode-gate reverse voltage ($V_{GAR} = 80\text{ V}$)	I_{GAR}	< 200	nA

1) di/dt are unlimited

Forward voltage

($I_F = 100 \text{ mA}$; $R_{GK} = 5 \text{ k}\Omega$)
 ($I_F = 300 \text{ mA}$; $R_{GK} = 5 \text{ k}\Omega$)
 Holding current ($R_{GK} = 5 \text{ k}\Omega$)

V_F	< 1.3	V
V_F	< 1.7	V
I_H	2 (0.3 to 6.5)	mA

Gate trigger current

($V_{AA} = 15 \text{ V}$; $R_L = 1 \text{ k}\Omega$;
 $t_{IGKT} > 50 \mu\text{s}$)

I_{GKT}	50 (< 100)	μA
-----------	------------	---------------

Turn-off current

($V_{AA} = 15 \text{ V}$; $R_L = 500 \Omega$; $t_{JGKQ} > 50 \mu\text{s}$;))

I_{GKQ}	10 (< 15)	mA
-----------	-----------	----

Gate trigger voltage

($V_{AA} = 15 \text{ V}$; $R_L = 1 \text{ k}\Omega$)

V_{GKT}	0.4 to 0.8	V
-----------	------------	---

Anode gate trigger current

($V_{AA} = 15 \text{ V}$; $R_L = 1 \text{ k}\Omega$)

I_{GAT}	< 3	mA
-----------	-----	----

Anode gate trigger voltage

($V_{AA} = 15 \text{ V}$; $R_L = 1 \text{ k}\Omega$;
 $R_{GK} = 5 \text{ k}\Omega$)

V_{GAT}	0.4 to 0.8	V
-----------	------------	---

Dynamic characteristics ($T_{amb} = 25^\circ\text{C}$)

Anode/cathode capacitance

($V_C = 20 \text{ V}$; $f = 1 \text{ MHz}$)

C_{AK}	3.5	pF
----------	-----	----

Switching times

Gate controlled turn-on time ($V_G = \pm 5 \text{ V}$;

$V_{AA} = 15 \text{ V}$)

t_{gt}	0.1 (< 0.3)	μs
----------	-------------	---------------

Gate controlled turn-off time $R_{GK} = 5 \text{ k}\Omega$;

$R_g = 500 \Omega$)

t_{gq}	< 5	μs
----------	-----	---------------

Turn-off time

($V_{AA} = 15 \text{ V}$; $R_L = 1 \text{ k}\Omega$; $R_{GK} = 5 \text{ k}\Omega$)

t_q	7	μs
-------	---	---------------

Critical rate of voltage rise¹⁾

($V_{AA} = 80 \text{ V}$; $R_{GK} = 100 \text{ k}\Omega$)

dv/dt	> 5	$\text{V}/\mu\text{s}$
---------	-----	------------------------

Test circuit for switching times

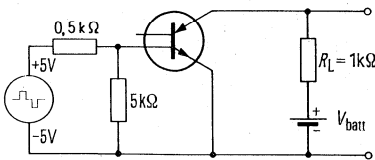

1) If the anode gate is connected to the anode supply voltage via a 220 kΩ resistor, the permissible voltage rise at the anode is unlimited.

These diffused silicon thyristors in TO 92 plastic package (10 A 3 DIN 41868) are intended for various applications of low performance, such as controls and regulations, counters, switches, etc. These thyristors are particularly recommended for entertainment and consumer electronics.

Type	Ordering code
BRY 55/30	Q68000-A114-F10
BRY 55/60	Q68000-A183-F10
BRY 55/100	Q68000-A184-F10
BRY 55/200	Q68000-A520-F10
BRY 55/300	Q68000-A185-F10

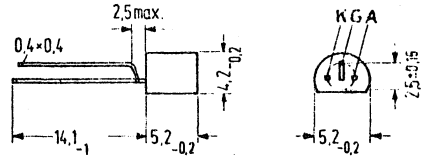

Mounting instruction:
Fixing hole $\varnothing 0.6$
Approx. weight 0.25 g

Dimensions in mm

Maximum ratings ($T_j = -40$ to $+125$ °C;
 $R_{GK} = 1000 \Omega$)

Neg. and pos. repetitive peak

off-state voltage

Max. rms on-state current

Surge on-state current,
sinusoidal pulse

$t_p < 10$ ms

$t_p < 100$ μ s

Peak gate forward current

Repetitive reverse gate voltage

Critical rate of current rise

$I_{TS} = 20$ A; $t_p < 10$ μ s

$I_{GT} = 1$ A; $t_r < 0.2$ s

$f_{max} = 50$ Hz

Storage temperature range

Junction temperature range

Average gate power dissipation

Peak gate power dissipation

	BRY 55/30	BRY 55/60	BRY 55/100	BRY 55/200	BRY 55/300	
V_{RR}/V_{DR}	30	60	100	200	300	V
I_T (rms)	0.8	0.8	0.8	0.8	0.8	A
I_{TS}	8	8	8	8	8	A
I_{TS}	20	20	20	20	20	A
I_{GFP}	0.5	0.5	0.5	0.5	0.5	A
$V_{(KG)R}$	6	6	6	6	6	V
di/dt	100	100	100	100	100	A/ μ s
T_{stg}	-40 to +125					°C
T_j	-40 to +125					°C
$P_{G(AV)}$	0.01	0.01	0.01	0.01	0.01	W
P_{GP}	0.1	0.1	0.1	0.1	0.1	W

Static characteristics ($T_{\text{case}} = 25^\circ\text{C}$)		BRY 55/30 ...	BRY 55/300
Continuous reverse blocking and off-state current ($R_{\text{GK}} = 1 \text{ k}\Omega$)	$I_{\text{R}}/I_{\text{D}}$	<1	μA
($T_{\text{j}} = 125^\circ\text{C}$)	$I_{\text{R}}/I_{\text{D}}$	<50	μA
Holding current ($R_{\text{GK}} = 1 \text{ k}\Omega$)	I_{H}	<5	mA
($T_{\text{j}} = -40^\circ\text{C}$)	I_{H}	<10	mA
Forward voltage ($I_{\text{TS}} = 1 \text{ A}$; $t_{\text{p}} = 1 \text{ ms}$)	V_{T}	<1.5	V
Gate-trigger current ($V_{\text{AK}} = 6 \text{ V}$; $R_{\text{L}} = 100 \Omega$)	I_{GT}	<200	μA
($T_{\text{j}} = -40^\circ\text{C}$)	I_{GT}	<500	μA
Gate-trigger voltage ($V_{\text{AK}} = 6 \text{ V}$; $R_{\text{L}} = 100 \Omega$)	V_{GT}	<0.8	V
($T_{\text{j}} = -40^\circ\text{C}$)	V_{GT}	<1	V
Gate non-trigger forward voltage ($V_{\text{D}} = V_{\text{DR}}$; $R_{\text{GK}} = 1 \text{ k}\Omega$; $T_{\text{j}} = 125^\circ\text{C}$)	V_{GF}	>0.1	V
Critical rate of voltage rise ($R_{\text{GK}} = 1 \text{ k}\Omega$; $V = 0.67 V_{\text{DWM}}$; $T_{\text{j}} = 125^\circ\text{C}$)	dv/dt	10	$\text{V}/\mu\text{s}$
Turn-off time ($R_{\text{GK}} = 1 \text{ k}\Omega$; $T_{\text{case}} = 125^\circ\text{C}$; $I_{\text{TS(rectangular)}} = 1 \text{ A}$; $t_{\text{p}} = 50 \mu\text{s}$; $V_{\text{R}} = 20 \text{ V}$; $V_{\text{AK}} = 0.67 V_{\text{DR}}$; $dv/dt = 5 \text{ V}/\mu\text{s}$)	t_{q}	30	μs
Turn-on time ($V_{\text{D}} = V_{\text{DR}}$; $R_{\text{L}} = 100 \Omega$; $R_{\text{GK}} = 1 \text{ k}\Omega$; $I_{\text{GTS}} = 1.5 \text{ mA}$; $t_{\text{p}} = 2 \mu\text{s}$; $t_{\text{r}} = 40 \text{ ns}$)	t_{on}	2	μs
Thermal resistance			
Junction to case	R_{thJC}	<125	K/W
Junction to ambient air	R_{thJA}	<230	K/W

Max. mean on-state current
 (sine) $I_{TAV} = f(T_{amb}); f = 50 \text{ to } 400 \text{ Hz}$

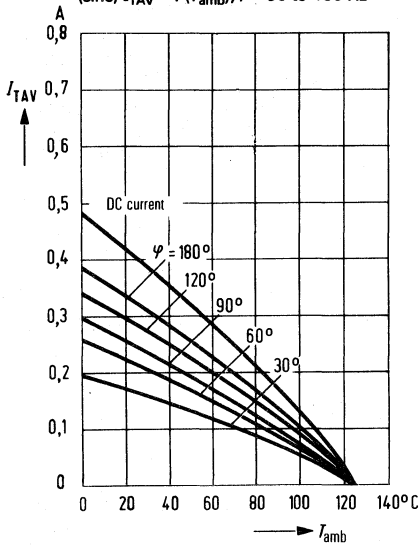

Forward characteristic
 (short-time power); $I_{TS} = f(V_T)$

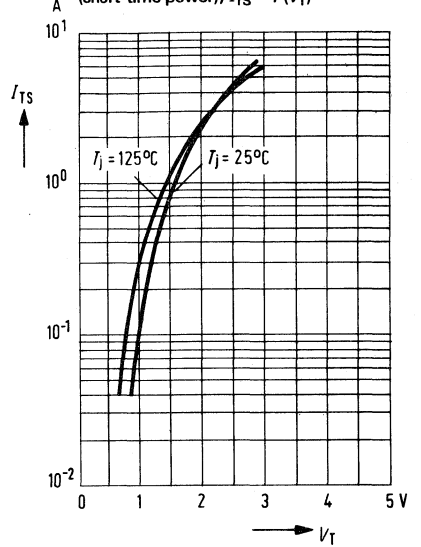

Power dissipation (sine) $I_{TAV} = f(T_{case})$
 $f = 50 \text{ to } 400 \text{ Hz}$

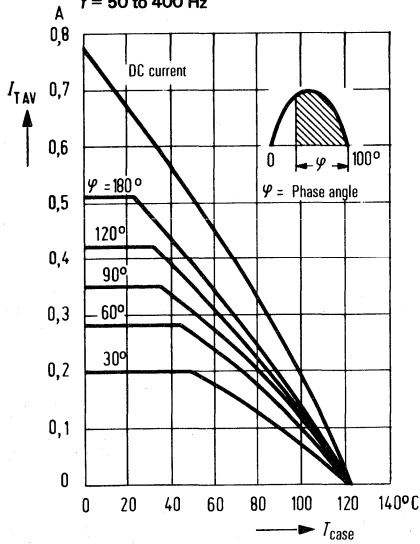

Power dissipation (sine) $P_{tot} = f(I_{TAV})$
 $f = 50 \text{ to } 400 \text{ Hz}; T = 125^\circ\text{C}$

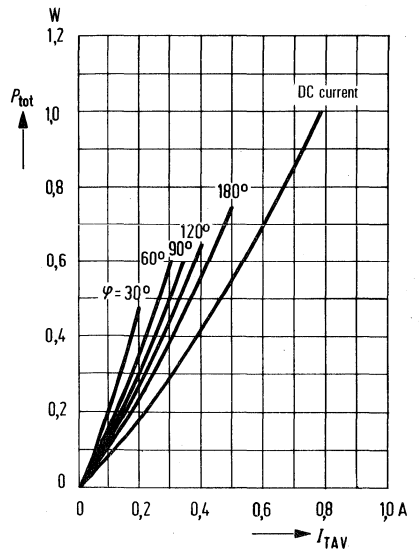

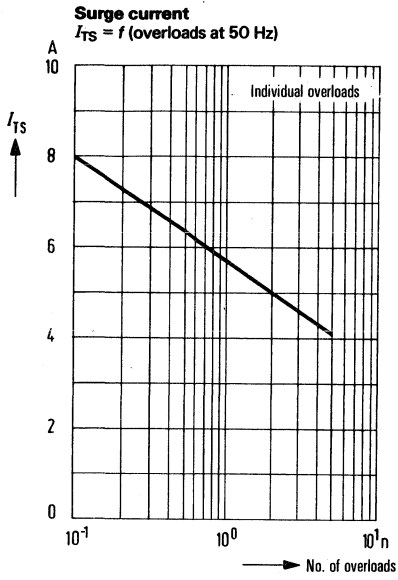

Programmable silicon planar unijunction transistor in TO 92 plastic package (10 A 3 DIN 41868).

Type	Ordering code
BRY 56 ¹⁾	Q68000-A803
BRY 56 A	Q68000-A803-S1
BRY 56 B	Q68000-A803-S2
BRY 56 C	Q68000-A803-S3

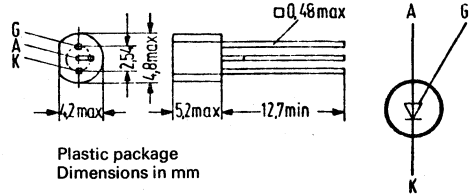

Maximum ratings

Voltage gate terminal cathode
Voltage gate terminal anode
Anode current, average value
($T_{amb} \leq 25^\circ\text{C}$)
($T_{case} \leq 85^\circ\text{C}$)
Anode current, peak value
($t = 10 \mu\text{s}$; $V_T = 0.001$)
Current increase to $I_A = 2.5 \text{ A}$
Overload current surge
($t = 10 \mu\text{s}$; $T_j = 150^\circ\text{C}$)
Junction temperature
Storage temperature range
Total power dissipation ($T_{amb} \leq 75^\circ\text{C}$)²⁾

	BRY 56 A BRY 56 B BRY 56 C	
V_{GC}	70	V
V_{GA}	70	V
$I_{A AV}$	175	mA
$I_{A AV}$	250	mA
I_{AM}	2.5	A
dI_A/dt	20	A/ μs
$i_A \text{ surge}$	3	A
T_j	150	$^\circ\text{C}$
T_{stg}	-65 to +150	$^\circ\text{C}$
P_{tot}	300	mW

Thermal resistance

Junction to ambient air²⁾ $R_{thJA} \leq 250 \text{ K/W}$

- 1) If a transistor is ordered without an exact indication of the current amplification wanted, then a transistor with a current amplification group available at stock will be delivered.
- 2) If mounted on PCBs with max. 3 mm long leads and a copper area of min. 10 x 10 mm for the anode terminal, then $R_{thJA} \leq 200 \text{ K/W}$, the power dissipation of 300 mW is then permitted up to $T_{amb} = 90^\circ\text{C}$.

Static characteristics ($T_{amb} = 25^{\circ}\text{C}$)

		BRY 56 A	BRY 56 B	BRY 56 C	
Peak point current at $V_S = 10\text{ V}$; $R_g = 10\text{ k}\Omega$	I_P	< 220	180 to 1100	900 to 5000	nA
Valley point current at $V_S = 10\text{ V}$; $R_g = 10\text{ k}\Omega$	I_V	≥ 2	≥ 10	≥ 50	μA
Peak point current at $V_S = 10\text{ V}$; $R_g = 100\text{ k}\Omega$	I_P	≥ 2	≥ 2	≥ 2	μA
Valley point current at $V_S = 10\text{ V}$; $R_g = 100\text{ k}\Omega$	I_V	≥ 5	≥ 5	≥ 5	μA
Forward voltage ($I_A = 100\text{ mA}$)	V_F	≥ 1.4	≥ 1.4	≥ 1.4	V
Cutoff current gate terminal anode ($V_S = 70\text{ V}$; $I_K = 0$)	I_{GAO}	≤ 10	≤ 10	≤ 10	nA
Cutoff current gate terminal cathode ($V_S = 70\text{ V}$; $V_{AK} = 0$)	I_{GKS}	≤ 100	≤ 100	≤ 100	nA
Offset voltage	V_T	$V_P - V_S$	-	-	V

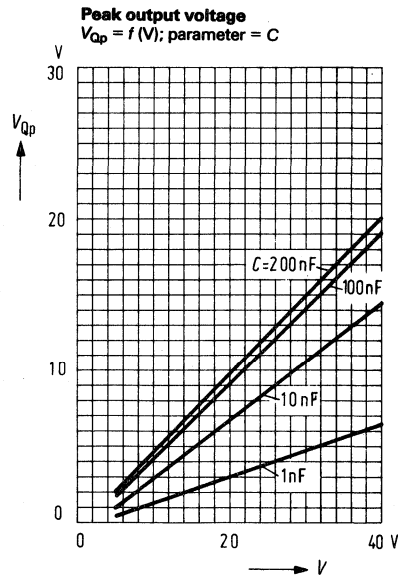
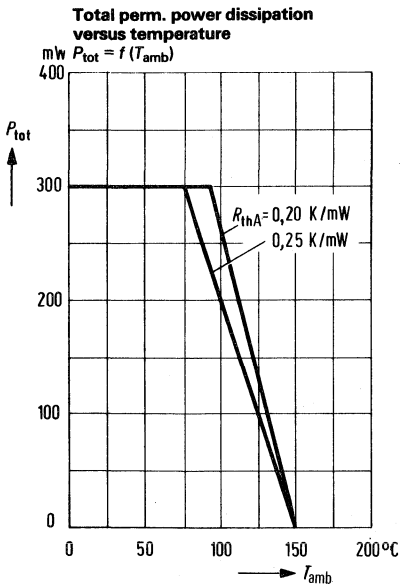

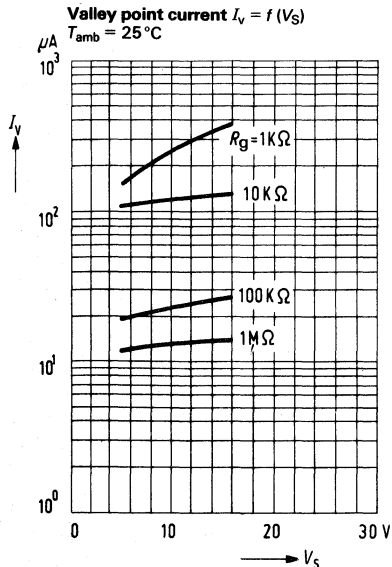
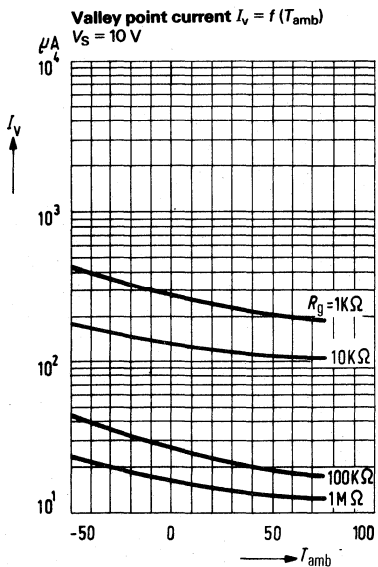
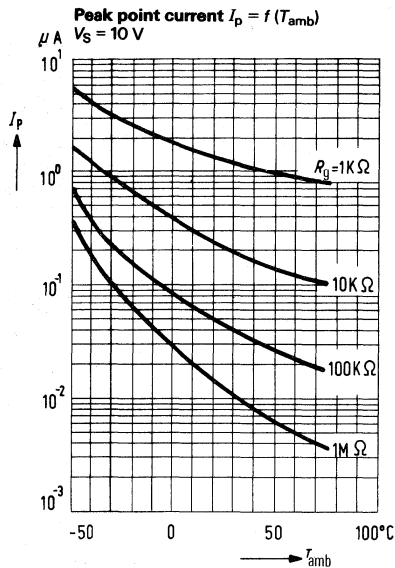
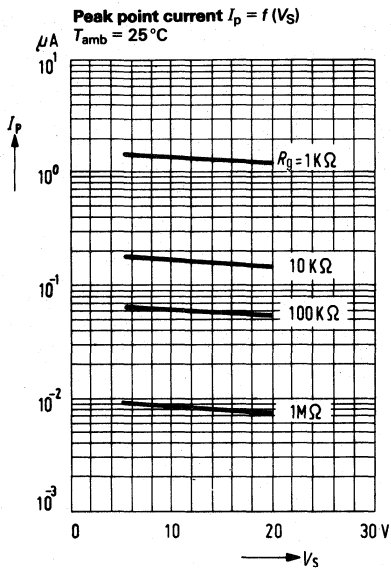

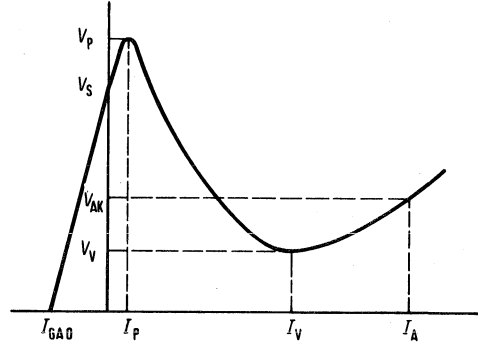
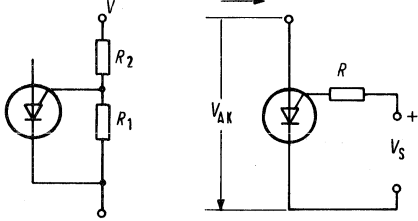

$$R_g = \frac{R_1 \cdot R_2}{R_1 + R_2}$$

$$V_S = \frac{R_1}{R_1 + R_2} \cdot V$$

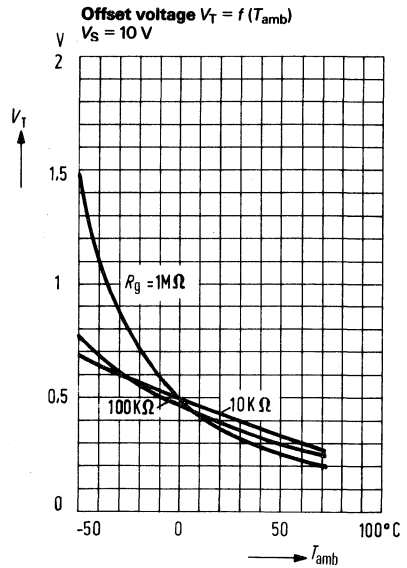
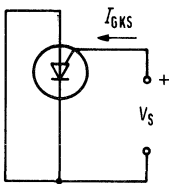
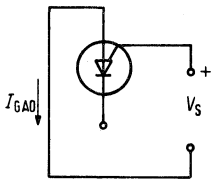

Rise time of output voltage at $V = 20\text{ V}$, $C = 10\text{ nF}$: $t_r \leq 80\text{ ns}$
 Peak value of output voltage at $V = 20\text{ V}$, $C = 0.2\text{ }\mu\text{F}$: $V_{Op} \geq 6\text{ V}$

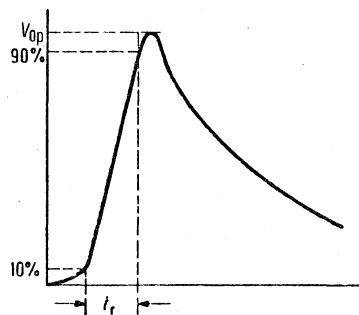
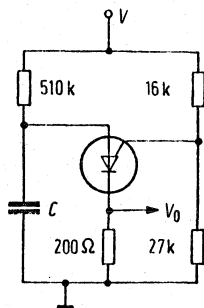

Test circuit

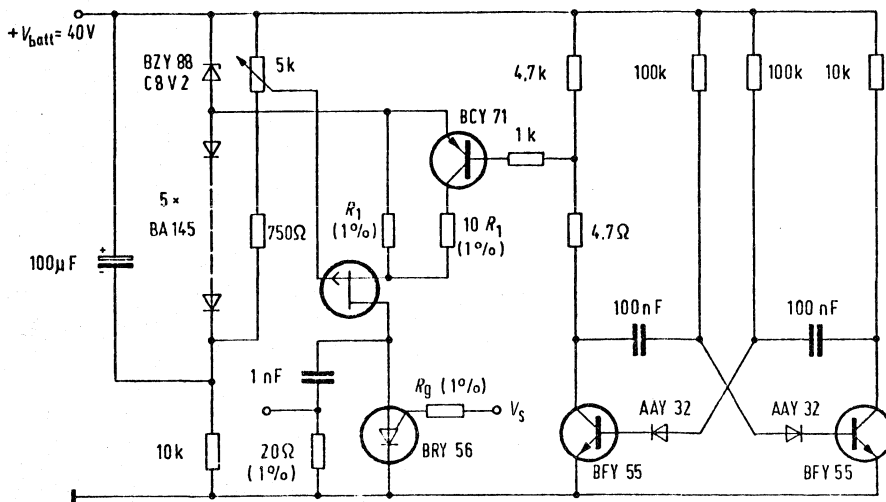

BSS 63 is an epitaxial PNP silicon planar transistor in TO 236 plastic package (23 A 3 DIN 41869) intended for AF applications in thin and thick film circuits of medium performance.

The transistor is marked with the code letters "BM".

Type	Mark	Ordering code
BSS 63	BM	Q62702-S401

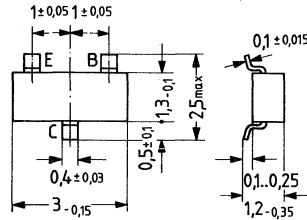

Approx. weight 0.02 g Dimensions in mm

Maximum ratings ($T_{amb} = 25\text{ }^{\circ}\text{C}$)

Collector-emitter voltage	$-V_{CEO}$	100	V
Collector-base voltage	$-V_{CBO}$	110	V
Emitter-base voltage	$-V_{EBO}$	6	V
Collector current	$-I_C$	100	mA
Collector peak current ($t < 10\text{ ms}$)	$-I_{CM}$	200	mA
Base peak current ($t < 10\text{ ms}$)	$-I_{BM}$	100	mA
Junction temperature	T_j	150	$^{\circ}\text{C}$
Storage temperature range	T_{stg}	-55 to +125	$^{\circ}\text{C}$
Total power dissipation ($T_{SB} = 50\text{ }^{\circ}\text{C}$)	P_{tot}	200	mW

Thermal resistance

Junction to ambient air	R_{thJA}	< 620	K/W
Junction to substrate back ¹⁾	R_{thJSB}	< 500	K/W

1) Ceramic substrate 0.7 mm; 2.5 cm² area

Static characteristics ($T_{amb} = 25^{\circ}\text{C}$)

Collector-emitter breakdown voltage ($-I_C = 10\text{ mA}$)	$-V_{(BR)CEO}$	> 100	V
Emitter-base breakdown voltage ($I_E = 10\text{ }\mu\text{A}$)	$-V_{(BR)EBO}$	> 6	V
Collector-base breakdown voltage ($-I_C = 10\text{ }\mu\text{A}$)	$-V_{(BR)CBO}$	> 110	V
Collector-emitter saturation voltage ($-I_C = 25\text{ mA}$; $-I_B = 2.5\text{ mA}$)	$-V_{CEsat}$	< 0.25	V
Collector-emitter saturation voltage ($-I_C = 75\text{ mA}$; $-I_B = 7.5\text{ mA}$)	$-V_{CEsat}$	< 0.9	V
Collector cutoff current ($-V_{CE} = 110\text{ V}$; $T_{amb} = 70^{\circ}\text{C}$)	$-I_{CES}$	< 10	μA
Collector cutoff current ($-V_{CE} = 100\text{ V}$; $R_{BE} = 10\text{ k}\Omega$)	$-I_{CER}$	< 10	μA
Emitter cutoff current ($-V_{BE} = 6\text{ V}$)	I_{EBO}	< 10	μA
DC current gain ($-V_{CE} = 5\text{ V}$; $-I_C = 10\text{ mA}$)	h_{FE}	> 30	-
($-V_{CE} = 5\text{ V}$; $-I_C = 20\text{ mA}$)	h_{FE}	> 30	-

Dynamic characteristics ($T_{amb} = 25^{\circ}\text{C}$)

Transition frequency ($-I_C = 25\text{ mA}$; $-V_{CE} = 5\text{ V}$; $f = 35\text{ MHz}$)	f_T	> 50	MHz
--	-------	--------	-----

Total perm. power dissipation versus temperature
 $P_{tot} = f(T_{amb})$

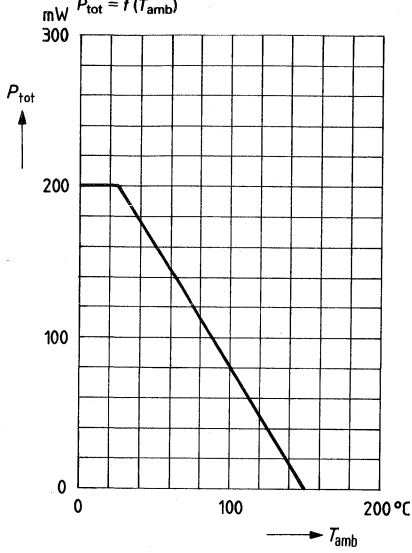

Perm. pulse load $\frac{r_{thJSB}}{R_{thJSB}} = f(t)$
 $D = \text{parameter}$

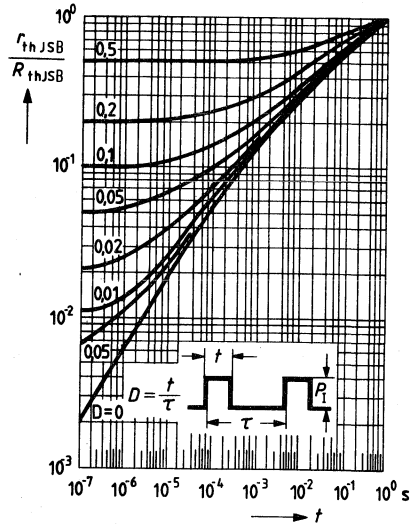

Collector cutoff current versus temperature $I_{CBO} = f(T_{amb})$
 $V_{CB} = 100$ V

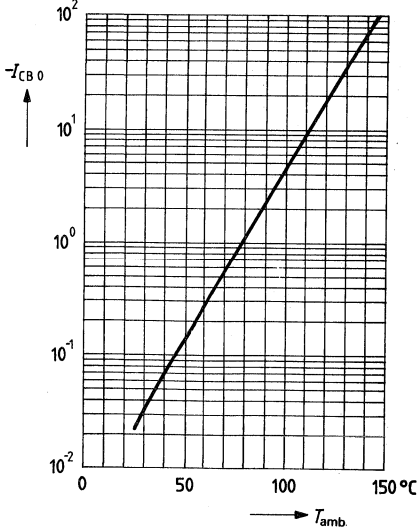

DC current $h_{FE} = f(I_C)$
 $V_{CE} = 5$ V; $T_{amb} = 25^{\circ}C$

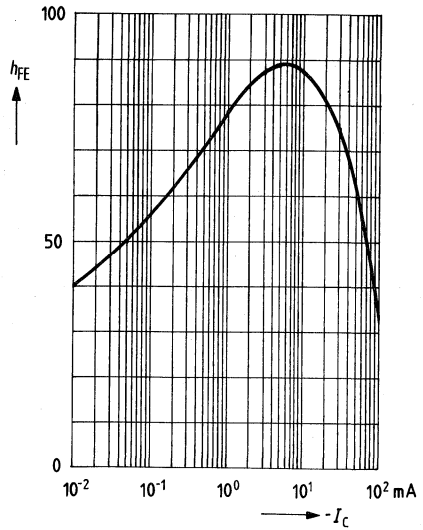

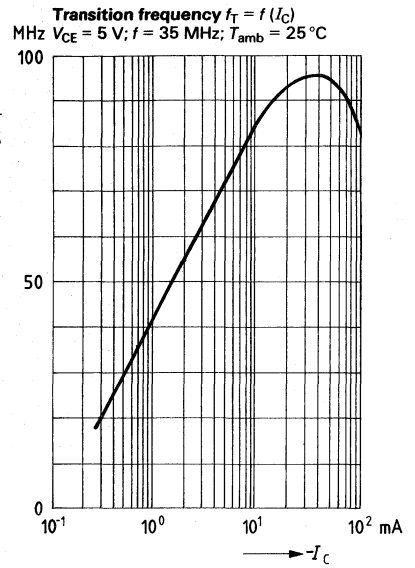
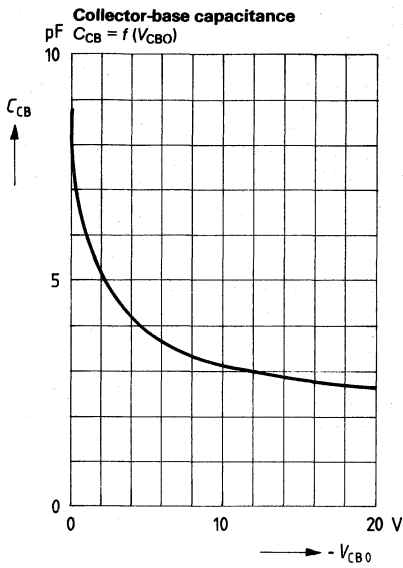

BSS 64 is an epitaxial NPN silicon planar transistor in TO 236 plastic package (23 A 3 DIN 41869) intended for AF applications in thin and thick film circuits of medium performance.

The transistor is marked with the code letters "AM".

Type	Mark	Ordering code
BSS 64	AM	Q62702-S394

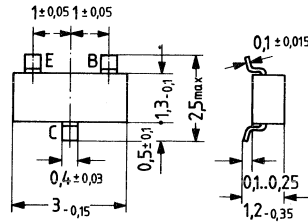

Approx. weight 0.02 g Dimensions in mm

Maximum ratings ($T_{amb} = 25\text{ }^{\circ}\text{C}$)

Collector-emitter voltage	V_{CEO}	80	V
Collector-base voltage	V_{CBO}	120	V
Emitter-base voltage	V_{EBO}	5	V
Collector current	I_C	100	mA
Collector peak current ($t < 10\text{ ms}$)	I_{CM}	250	mA
Base peak current ($t < 10\text{ ms}$)	I_{BM}	100	mA
Junction temperature	T_j	150	$^{\circ}\text{C}$
Storage temperature range	T_{stg}	-55 to +125	$^{\circ}\text{C}$
Total power dissipation ($T_{SB} = 50\text{ }^{\circ}\text{C}$)	P_{tot}	200	mW

Thermal resistance

Junction to ambient air	R_{thJA}	< 620	K/W
Junction to substrate back ¹⁾	R_{thJSB}	< 500	K/W

1) Ceramic substrate 0.7 mm; 2.5 cm² area

Static characteristics ($T_{amb} = 25^{\circ}\text{C}$)

Collector-emitter breakdown voltage

($I_C = 4\text{ mA}$)

$V_{(BR)CEO}$	> 80	V
---------------	------	---

Emitter-base breakdown voltage

($I_E = 100\ \mu\text{A}$)

$V_{(BR)EBO}$	> 5	V
---------------	-----	---

Collector-base breakdown voltage

($I_C = 100\ \mu\text{A}$)

$V_{(BR)CBO}$	> 120	V
---------------	-------	---

Collector-emitter saturation voltage

($I_C = 4\text{ mA}$; $I_B = 400\ \mu\text{A}$)

V_{CEsat}	< 0.7	V
-------------	-------	---

Collector-emitter saturation voltage

($I_C = 50\text{ mA}$; $I_B = 15\text{ mA}$)

V_{CEsat}	< 3	V
-------------	-----	---

Collector cutoff current

($V_{CE} = 80\text{ V}$; $T_{amb} = 70^{\circ}\text{C}$)

I_{CES}	< 20	μA
-----------	------	---------------

Emitter cutoff current

($V_{EB} = 4\text{ V}$)

I_{EBO}	< 200	nA
-----------	-------	----

DC current gain

($V_{CE} = 1\text{ V}$; $I_C = 1\text{ mA}$)

h_{FE}	60	-
----------	----	---

($V_{CE} = 1\text{ V}$; $I_C = 4\text{ mA}$)

h_{FE}	80 (> 20)	-
----------	-----------	---

($V_{CE} = 1\text{ V}$; $I_C = 10\text{ mA}$)

h_{FE}	82	-
----------	----	---

($V_{CE} = 1\text{ V}$; $I_C = 20\text{ mA}$)

h_{FE}	55	-
----------	----	---

Dynamic characteristics ($T_{amb} = 25^{\circ}\text{C}$)

Transition frequency

($I_C = 4\text{ mA}$; $V_{CE} = 10\text{ V}$; $f = 35\text{ MHz}$)

f_T	> 50	MHz
-------	------	-----

Total perm. power dissipation versus temperature
 $P_{tot} = f(T_{amb})$

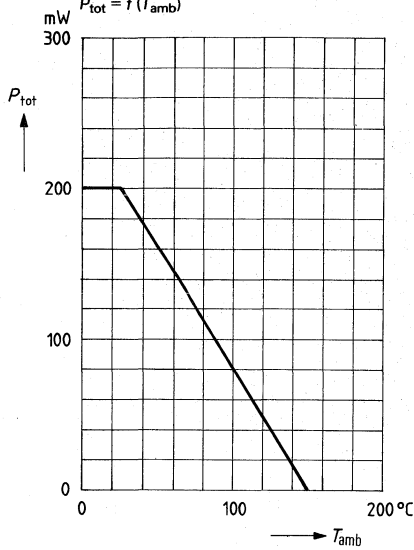

Perm. pulse load $\frac{r_{thJSB}}{R_{thJSB}} = f(t)$
 $D = \text{parameter}$

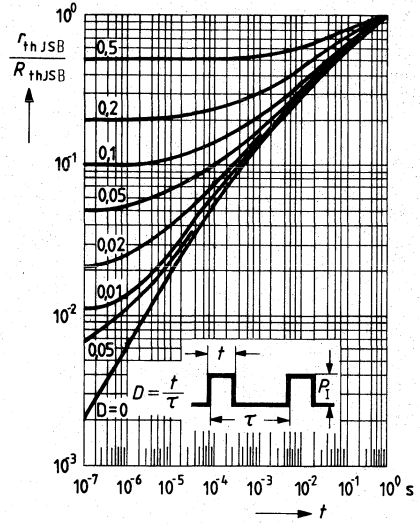

Collector cutoff current versus temperature
 $I_{CBO} = f(T_{amb})$

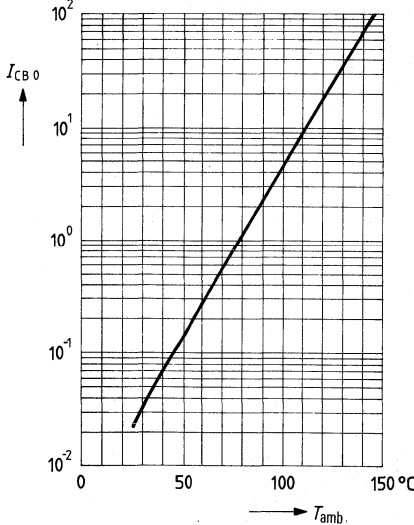

DC current gain $h_{FE} = f(I_C)$
 $V_{CE} = 5$ V; $T_{amb} = 25^{\circ}C$

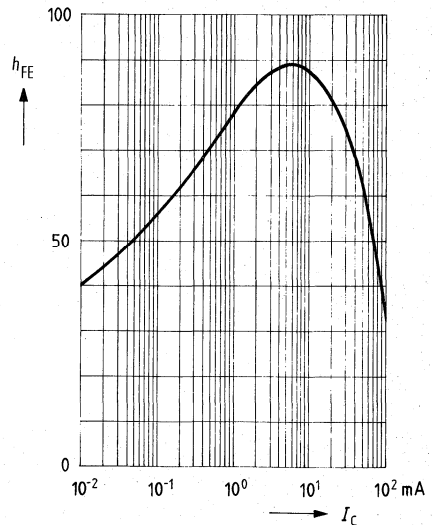

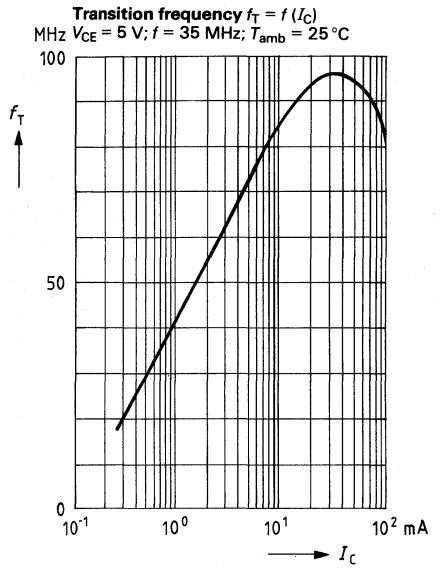
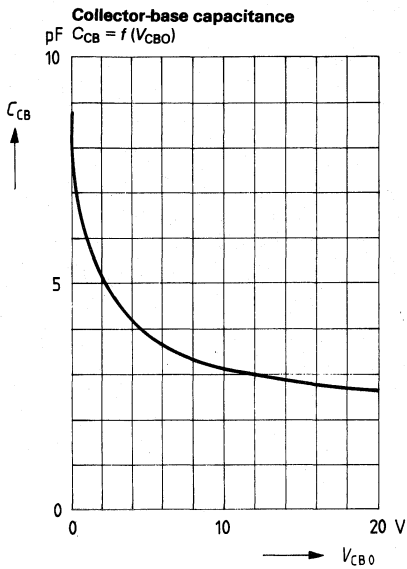

BSS 79 and BSS 81 are epitaxial NPN silicon planar transistors in TO 236 plastic package (23 A 3 DIN 41869).

These transistors are particularly suitable for fast switching and general AF applications of medium performance for use in thin and thick film circuits. The transistors are marked with the following code letters:

Type	Mark	Ordering code
BSS 79 ²⁾		Q62702-S421
BSS 79 B	CE	Q62702-S403
BSS 79 C	CF	Q62702-S402
BSS 81 ²⁾		Q62702-S422
BSS 81 B	CD	Q62702-S420
BSS 81 C	CG	Q62702-S419

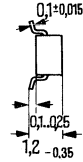
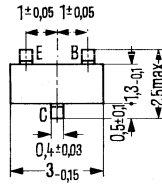

Approx. weight 0.02 g

Dimensions in mm

Maximum ratings ($T_{amb} = 25\text{ }^{\circ}\text{C}$)

Collector-emitter voltage
 Collector-base voltage
 Emitter-base voltage
 Collector current
 Base current
 Junction temperature
 Storage temperature range
 Total power dissipation ($T_{SB} = 60\text{ }^{\circ}\text{C}$)

	BSS 79	BSS 81	
V_{CEO}	40	35	V
V_{CBO}	75	75	V
V_{EBO}	6	6	V
I_C	800	800	mA
I_B	100	100	mA
T_j	150	150	$^{\circ}\text{C}$
T_{stg}	-55 to +125		$^{\circ}\text{C}$
P_{tot}	350	350	mW

Thermal resistance

Junction to ambient air
 Junction to substrate back¹⁾

R_{thJA}	< 360	< 360	K/W
R_{thJSB}	< 260	< 260	K/W

1) Ceramic substrate 0.7 mm; 2.5 cm² area.

2) In case of orders without an exact indication of the current amplification wanted, a transistor will be delivered of that current amplification group available at stock.

Static characteristics ($T_{amb} = 25^{\circ}\text{C}$)

Collector-base breakdown voltage
($I_C = 10 \mu\text{A}$)
Collector-emitter breakdown voltage
($I_C = 10 \text{ mA}$)
Emitter-base breakdown voltage
($I_E = 10 \mu\text{A}$)
Collector-emitter saturation voltage
($I_B = 15 \text{ mA}$; $I_C = 150 \text{ mA}$)
($I_B = 50 \text{ mA}$; $I_C = 500 \text{ mA}$)
Emitter cutoff current
($V_{BE} = 3 \text{ V}$)
Collector cutoff current
($V_{CB} = 60 \text{ V}$)
($V_{CB} = 60 \text{ V}$; $T_{amb} = 150^{\circ}\text{C}$)
DC current gain
($I_C = 150 \text{ mA}$; $V_{CE} = 10 \text{ V}$) group B:
($I_C = 150 \text{ mA}$; $V_{CE} = 10 \text{ V}$) group C;

	BSS 79	BSS 81	
$V_{(BR)CBO}$	> 75	> 75	V
$V_{(BR)CEO}$	> 40	> 35	V
$V_{(BR)EBO}$	> 6	> 6	V
V_{CEsat}	< 0.3	< 0.3	V
V_{CEsat}	< 1.0	< 1.0	V
I_{EBO}	10	10	nA
I_{CBO}	< 10	< 10	nA
I_{CBO}	< 10	< 10	μA
h_{FE}	40 to 120		-
h_{FE}	100 to 300		-

Dynamic characteristics ($T_{amb} = 25^{\circ}\text{C}$)

Transition frequency
($V_{CE} = 20 \text{ V}$; $I_C = 20 \text{ mA}$; $f = 100 \text{ MHz}$)
Collector capacitance
($V_{CB} = 10 \text{ V}$; $f = 1 \text{ MHz}$)
Switching times:
($V_{CC} = 30 \text{ V}$; $I_C = 150 \text{ mA}$; I_{B1} approx I_{B2}
approx 15 mA)
Delay time
Rise time
Storage time
Fall time

f_T	> 250	> 250	MHz
C_{CBO}	< 8	< 8	pF
t_d	< 10	< 10	ns
t_r	< 10	< 10	ns
t_s	< 225	< 225	ns
t_f	< 60	< 60	ns

Test circuit for switching times

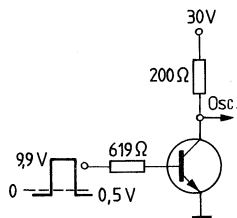

Osc.:
R > 100 k
C < 12 pF
 t_r < 5 ns

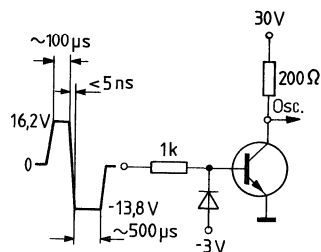

Osc.:
R > 100 k
C < 12 pF
 t_r < 5 ns

Total perm. power dissipation versus temperature
 $P_{tot} = f(T)$

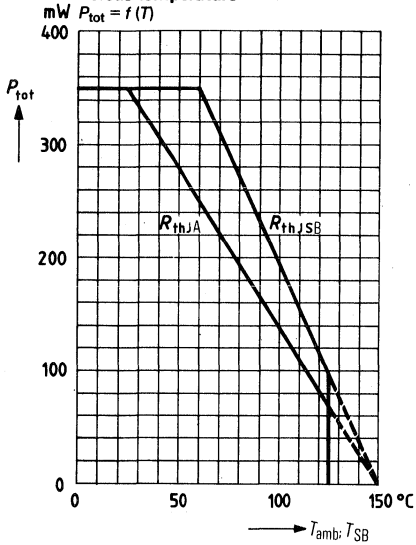

Perm. pulse load $\frac{r_{thJSB}}{R_{thJSB}} = f(t)$
 $D = \text{parameter}$

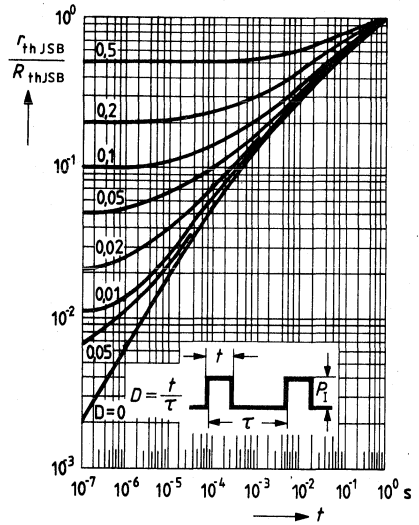

DC current gain $h_{FE} = f(I_C)$
 $V_{CE} = 1 \text{ V}, V_{CE} = 10 \text{ V}; T_{amb} = 25^\circ \text{C}$

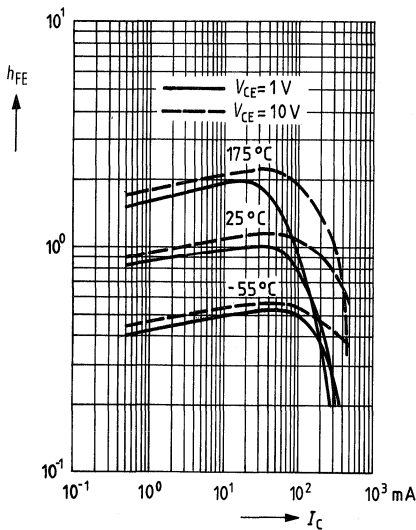

Saturation voltages

$V_{BE sat} = f(I_C), V_{CE sat} = f(I_C)$
 $h_{FE} = 10; T_{amb} = 25^\circ \text{C}$

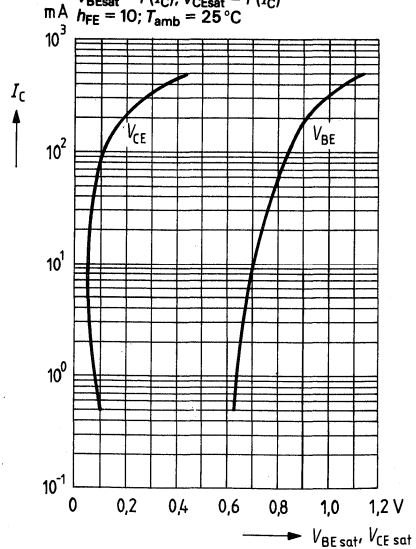

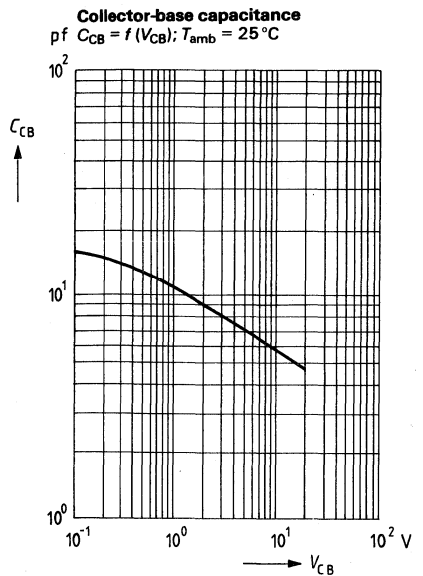
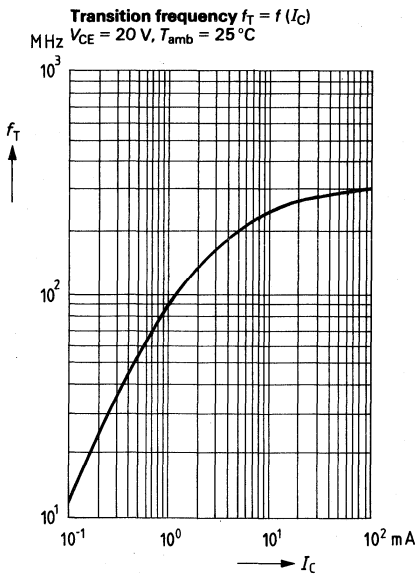
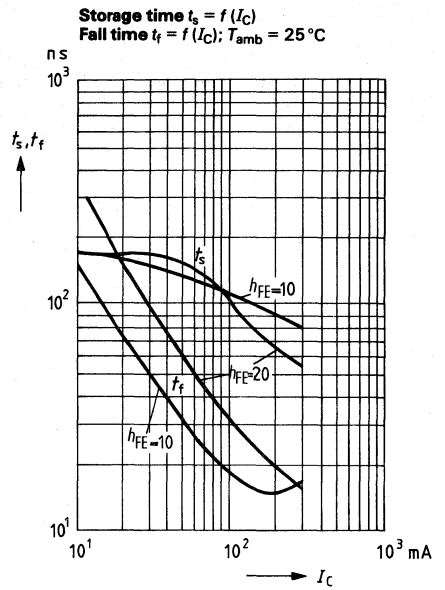
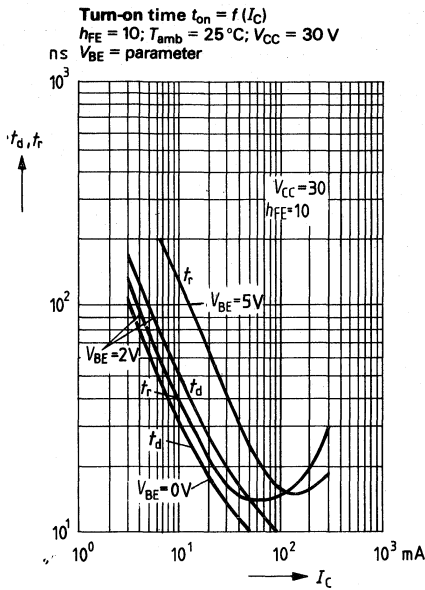

BSS 80 and BSS 82 are epitaxial PNP silicon planar transistors in TO 236 plastic package (23 A 3 DIN 41 869).

These transistors are particularly suitable for fast switching and general AF applications of medium performance for use in thin and thick film circuits. The transistors are marked with the following code letters.

Type	Mark	Ordering code
BSS 80 ¹⁾		Q62702-S424
BSS 80 B	CH	Q62702-S398
BSS 80 C	CJ	Q62702-S399
BSS 82 ¹⁾		Q62702-S423
BSS 82 B	CL	Q62702-S409
BSS 82 C	CM	Q62702-S408

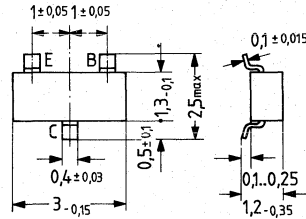

Approx. weight 0.02 g Dimensions in mm

Maximum ratings ($T_{amb} = 25\text{ }^{\circ}\text{C}$)

	BSS 80	BSS 82		
Collector-emitter voltage	-V _{CEO}	40	60	V
Collector-base voltage	-V _{CBO}	60	60	V
Emitter-base voltage	-V _{EBO}	5	5	V
Collector current	-I _C	800	800	mA
Base current	-I _B	100	100	mA
Junction temperature	T _j	150	150	°C
Storage temperature range	T _{stg}	-55 to +125	-55 to +125	°C
Total power dissipation (T _{SB} = 60 °C)	P _{tot}	350	350	mW

Thermal resistance

Junction to ambient air	R _{thJA}	< 360	< 360	K/W
Junction to substrate back	R _{thJSB}	< 260	< 260	K/W

1) In case of orders without an exact indication of the current amplification wanted, a transistor will be delivered of that current amplification group available at stock.

Static characteristics ($T_{amb} = 25^{\circ}\text{C}$)

Collector-base breakdown voltage

($-I_C = 10 \mu\text{A}$)

Collector-emitter breakdown voltage

($-I_C = 10 \text{ mA}$)

Emitter-base breakdown voltage

($I_E = 10 \mu\text{A}$)

Collector-emitter saturation voltage

($-I_B = 15 \text{ mA}$; $-I_C = 150 \text{ mA}$)

($-I_B = 50 \text{ mA}$; $-I_C = 500 \text{ mA}$)

Emitter cutoff current

($-V_{BE} = 3 \text{ V}$)

Collector cutoff current

($-V_{CB} = 50 \text{ V}$)

($-V_{CB} = 50 \text{ V}$; $T_{amb} = 150^{\circ}\text{C}$)

DC current gain

($-I_C = 150 \text{ mA}$; $-V_{CE} = 10 \text{ V}$) group B:

($-I_C = 150 \text{ mA}$; $-V_{CE} = 10 \text{ V}$) group C:

	BSS 80	BSS 82	
$-V_{(BR)CBO}$	>60	>60	V
$-V_{(BR)CEO}$	>40	>60	V
$-V_{(BR)EBO}$	>5	>5	V
$-V_{CEsat}$	<0.4	<0.4	V
$-V_{CESat}$	<1.6	<1.6	V
$-I_{EBO}$	<10	<10	nA
$-I_{CBO}$	<10	<10	nA
$-I_{CBO}$	<10	<10	μA
h_{FE}	40 to 120	40 to 120	-
h_{FE}	100 to 300	100 to 300	-

Dynamic characteristics ($T_{amb} = 25^{\circ}\text{C}$)

Transition frequency

($-V_{CE} = 20 \text{ V}$; $-I_C = 50 \text{ mA}$; $f = 100 \text{ MHz}$)

Collector capacitance

($V_{CB} = 10 \text{ V}$; $f = 1 \text{ MHz}$)

Switching times:

($V_{CC} = 30 \text{ V}$; $I_C = 150 \text{ mA}$; I_{B1} approx. I_{B2}

approx. 15 mA)

Delay time

Rise time

Storage time

Fall time

f_T	>200	>200	MHz
C_{CBO}	<8	<8	pF
t_d	<10	<10	ns
t_r	<40	<40	ns
t_s	<80	<80	ns
t_f	<30	<30	ns

Test circuit for switching time

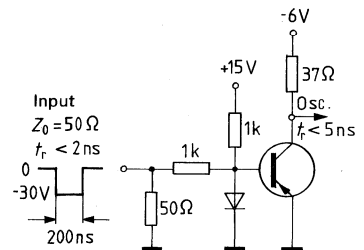
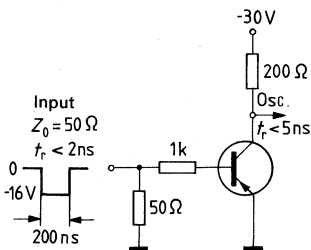

Total perm. power dissipation versus temperature

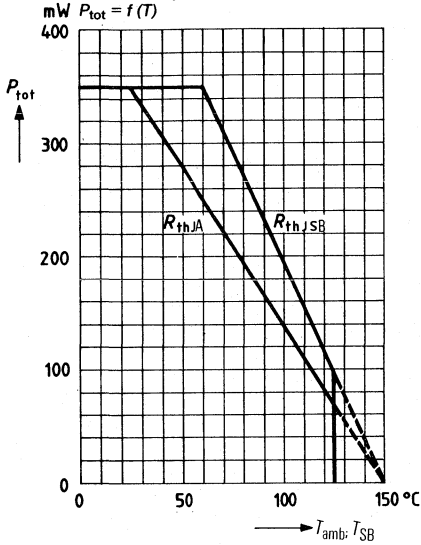

Collector-base capacitance
 $C_{CB} = f(V_{CB}); T_{amb} = 25^{\circ}C$

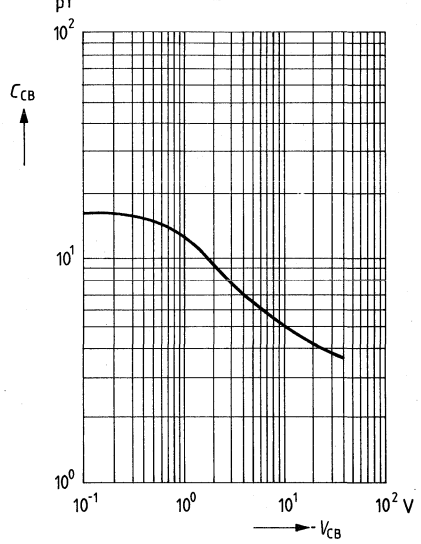

DC current gain $h_{FE} = f(I_C)$
 $V_{CE} = 1 V, V_{CE} = 10 V; T_{amb} = 25^{\circ}C$

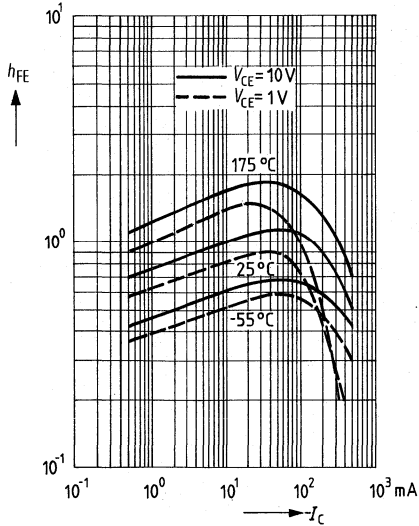

Saturation voltages
 $V_{BEsat} = f(I_C), V_{CEsat} = f(I_C)$
 $h_{FE} = 10; T_{amb} = 25^{\circ}C$

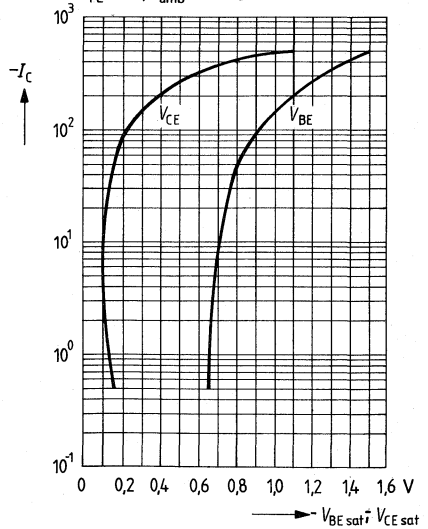

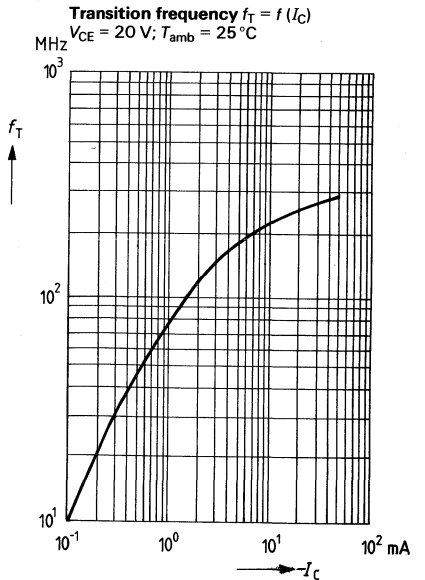
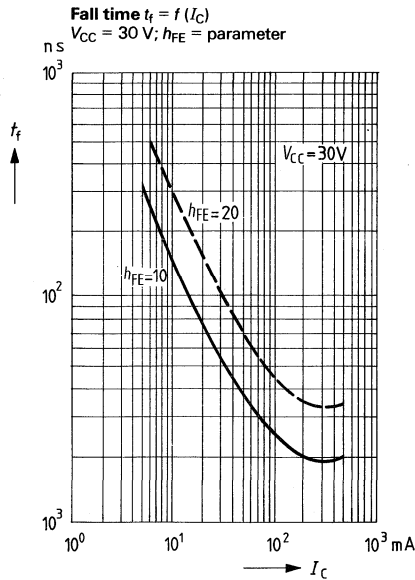
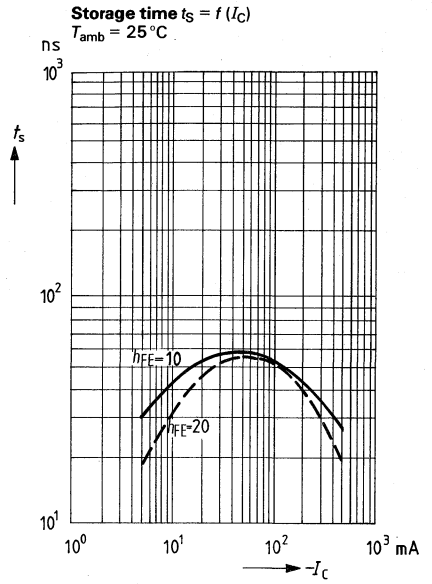
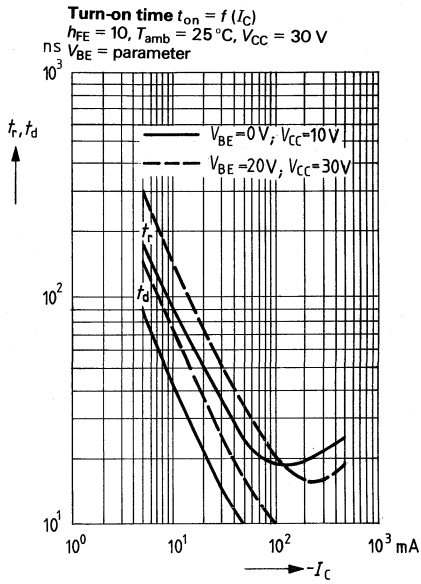

BSV 15, BSV 16 and BSV 17 are epitaxial PNP silicon planar transistors in TO 39 case (5 C 3 DIN 41873). The collector is electrically connected to the case. The transistors are particularly suitable for use in AF amplifiers and for AF switching applications.

Type	Ordering code
BSV 15 ¹⁾	Q62702-S425
BSV 15-6	Q62702-S207
BSV 15-10	Q62702-S208
BSV 15-16	Q62702-S209
BSV 16 ¹⁾	Q62702-S426
BSV 16-6	Q62702-S210
BSV 16-10	Q62702-S211
BSV 16-16	Q62702-S212
BSV 17 ¹⁾	Q62702-S427
BSV 17-6	Q62702-S213
BSV 17-10	Q62702-S214

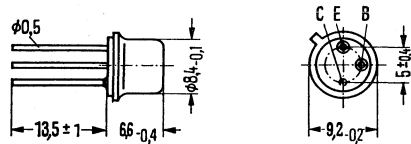

Approx. weight 1.5 g

Dimensions in mm

Maximum ratings

	BSV 15	BSV 16	BSV 17		
Collector-emitter voltage	-V _{CEO}	40	60	80	V
Collector-emitter voltage	-V _{CES}	40	60	80	V
Emitter-base voltage	-V _{EBO}	5	5	5	V
Collector current	-I _C	1	1	1	A
Base current	-I _B	0.2	0.2	0.2	A
Junction temperature	T _j	200	200	200	°C
Storage temperature range	T _{stg}	-65 to +200			°C
Total power dissipation (T _{case} ≤ 25 °C)	P _{tot}	5	5	5	W

Thermal resistance

Junction to ambient air	R _{thJA}	≤ 200	≤ 200	≤ 200	K/W
Junction to case	R _{thJC}	≤ 35	≤ 35	≤ 35	K/W

1) In case of orders without an exact indication of the current amplification wanted, a transistor will be delivered of that current amplification group available at stock.

Static characteristics ($T_{amb} = 25^{\circ}\text{C}$)

The transistors BSV 15, BSV 16 and BSV 17 are grouped according to the DC current gain at $-I_C = 100\text{ mA}$ and marked with figures of the DIN R 5 standard series. At a voltage of $V_{CE} = 1\text{ V}$ the following values apply:

Type	BSV 15 BSV 16 BSV 17	BSV 15 BSV 16 BSV 17	BSV 15 BSV 16	BSV 15 BSV 16 BSV 17
h_{FE} group	6	10	16	
I_C mA	h_{FE} I_C/I_B	h_{FE} I_C/I_B	h_{FE} I_C/I_B	V_{BE} V
0.1	44 (> 15)	75 (> 20)	120 (> 30)	-
100	63 (40 to 100)	100 (63 to 160)	160 (100 to 250)	< 1
500	40 (> 20)	55 (> 25)	85 (> 35)	0.85 (0.7 to 1.4)

Static characteristics ($T_{amb} = 25^{\circ}\text{C}$)

	BSV 15	BSV 16	BSV 17		
Collector-emitter saturation voltage ($-I_C = 500\text{ mA}$; $I_B = 25\text{ mA}$)	$-V_{CEsat}$	< 1	< 1	< 1	V
Collector cutoff current ($-V_{CE} = 40\text{ V}$)	$-I_{CES}$	< 100	-	-	nA
Collector cutoff current ($-V_{CE} = 40\text{ V}$; $T_{amb} = 150^{\circ}\text{C}$)	$-I_{CES}$	< 50	-	-	μA
Collector cutoff current ($-V_{CE} = 60\text{ V}$)	$-I_{CES}$	-	< 100	-	nA
Collector cutoff current ($-V_{CE} = 60\text{ V}$; $T_{amb} = 150^{\circ}\text{C}$)	$-I_{CES}$	-	< 50	-	μA
Collector cutoff current ($-V_{CE} = 80\text{ V}$)	$-I_{CES}$	-	-	< 100	nA
Collector cutoff current ($-V_{CE} = 80\text{ V}$; $T_{amb} = 150^{\circ}\text{C}$)	$-I_{CES}$	-	-	< 50	μA
Emitter cutoff current ($-V_{EB} = 4\text{ V}$)	$-I_{EBO}$	< 50	< 50	< 50	nA
Collector cutoff current ($-V_{CE} = 40\text{ V}$; $-V_{BE} = 0.2\text{ V}$; $T_{amb} = 100^{\circ}\text{C}$)	$-I_{CEX}$	< 50	-	-	μA
Collector cutoff current ($-V_{CE} = 60\text{ V}$; $-V_{BE} = 0.2\text{ V}$; $T_{amb} = 100^{\circ}\text{C}$)	$-I_{CEX}$	-	< 50	-	μA
Collector cutoff current ($-V_{CE} = 80\text{ V}$; $-V_{BE} = 0.2\text{ V}$; $T_{amb} = 100^{\circ}\text{C}$)	I_{CEX}	-	-	< 50	μA
Collector-emitter reverse voltage ($-I_{CE} = 50\text{ mA}$; $v = 200\text{ }\mu\text{s}$; 1%)	$-V_{CEO}$	> 40	> 60	> 80	V
Collector-emitter voltage ($-I_{CE} = 10\text{ }\mu\text{A}$)	$-V_{CES}$	> 40	> 60	> 90	V
Emitter-base reverse voltage ($-I_{EBO} = 10\text{ }\mu\text{A}$)	$-V_{EBO}$	> 5	> 5	> 5	V

Dynamic characteristics ($T_{amb} = 25^{\circ}\text{C}$)

	BSV 15	BSV 16	BSV 17	
Transition frequency ($I_C = 50 \text{ mA}$; $V_{CE} = 10 \text{ V}$, $f = 20 \text{ MHz}$)	f_T	> 50	> 50	MHz
Collector-base capacitance ($V_{CBO} = 10 \text{ V}$; $I_E = 0$; $f = 1 \text{ MHz}$)	C_{CBO}	20 (<30)	15 (<25)	pF
Emitter-base capacitance ($V_{EBO} = 0.5 \text{ V}$; $I_C = 0$; $f = 1 \text{ MHz}$)	C_{EBO}	180	180	pF
Small-signal current gain ($I_C = 1 \text{ mA}$; $V_{CE} = 5 \text{ V}$; $f = 1 \text{ kHz}$)	h_{fe}	> 20	> 20	–
Switching times:				
Turn-on time ($I_C = 100 \text{ mA}$; I_{B1} approx. $-I_{B2}$ approx. 5 mA) t_{on}		< 500	< 500	ns
Storage time ($I_C = 100 \text{ mA}$; I_{B1} approx. $-I_{B2}$ approx. 5 mA) t_s		< 500	< 500	ns
Fall time ($I_C = 100 \text{ mA}$; I_{B1} approx. $-I_{B2}$ approx. 5 mA) t_f		< 150	< 150	ns

Test circuit for switching times
Test circuit for $I_C = 100 \text{ mA}$

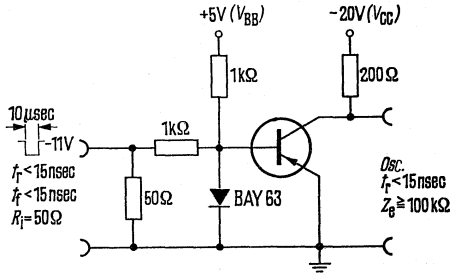

Total perm. power dissipation versus temperature
 $P_{tot} = f(T); V_{CE} = \text{parameter}$

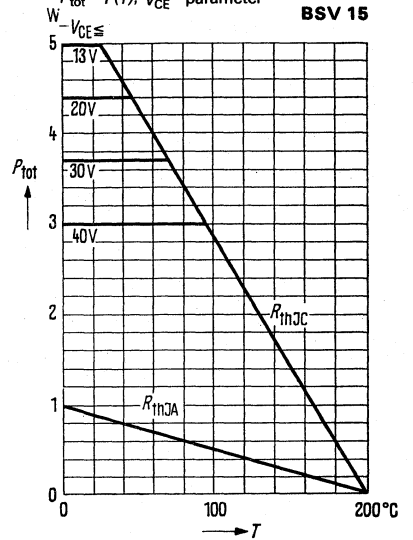

Total perm. power dissipation versus temperature
 $P_{tot} = f(T); V_{CE} = \text{parameter}$

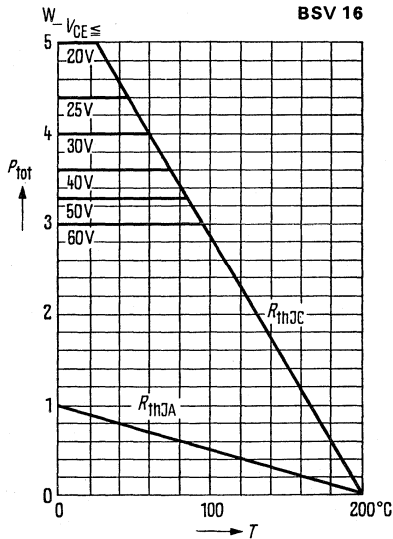

Total perm. power dissipation versus temperature
 $P_{tot} = f(T); V_{CE} = \text{parameter}$

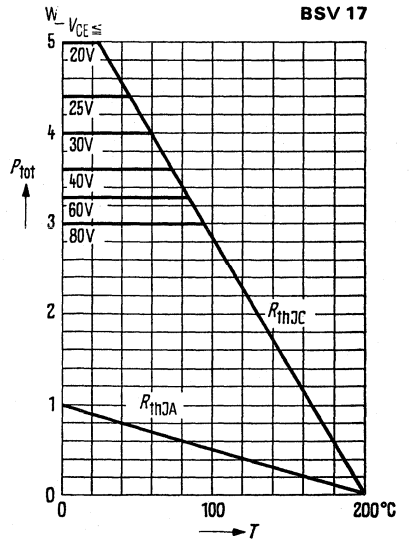

Permissible pulse load
 $r_{thJC} = f(t)$; $v = \text{parameter}$
BSV 15, BSV 16, BSV 17

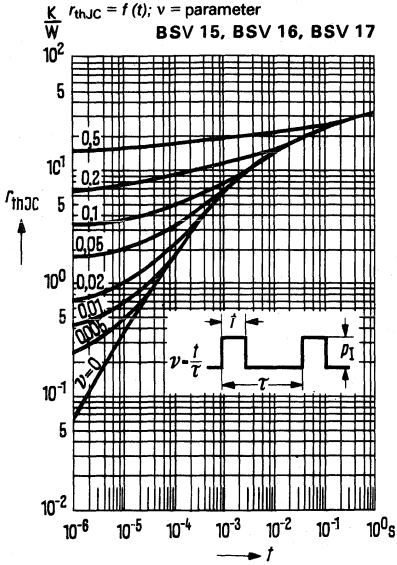

DC current gain $h_{FE} = f(I_C)$
 $-V_{CE} = 1 \text{ V}$; $T_{amb} = \text{parameter}$
BSV 15-6, BSV 16-6, BSV 17-6

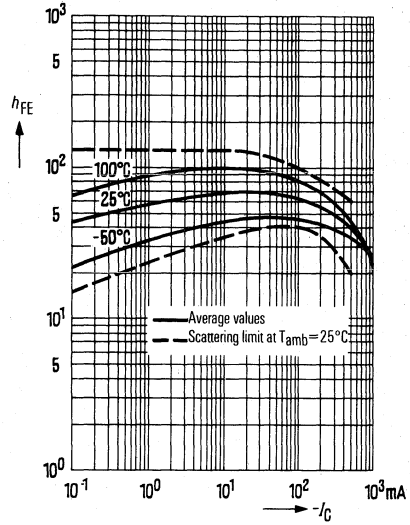

DC current gain $h_{FE} = f(I_C)$
 $-V_{EC} = 1 \text{ V}$; $T_{amb} = \text{parameter}$

BSV 15-10, BSV 16-10, BSV 17-10

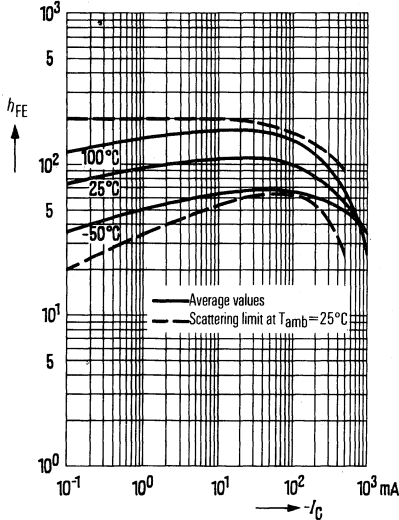

DC current gain $h_{FE} = f(I_C)$
 $-V_{CE} = 1 \text{ V}$; $T_{amb} = \text{parameter}$

BSV 15-16, BSV 16-16

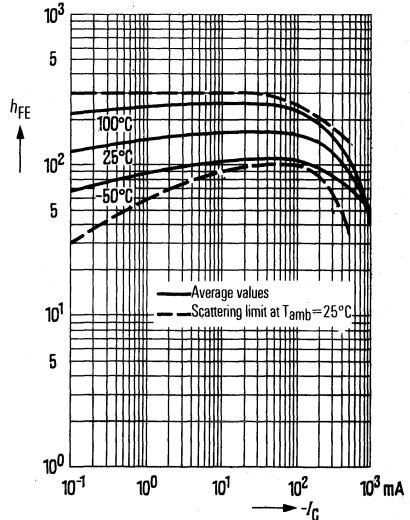

Permissible operating range
 $I_C = f(V_{CE}); T_{case} = 60^\circ C$

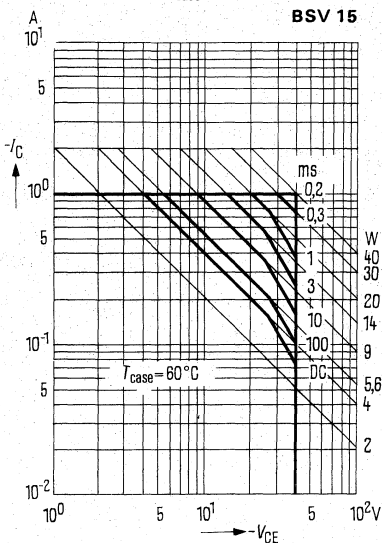

Permissible operating range
 $I_C = f(V_{CE}); T_{case} = 125^\circ C$

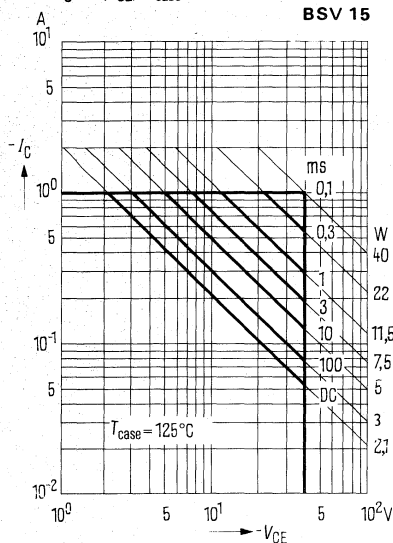

Permissible operating range
 $I_C = f(V_{CE}); T_{case} = 60^\circ C$

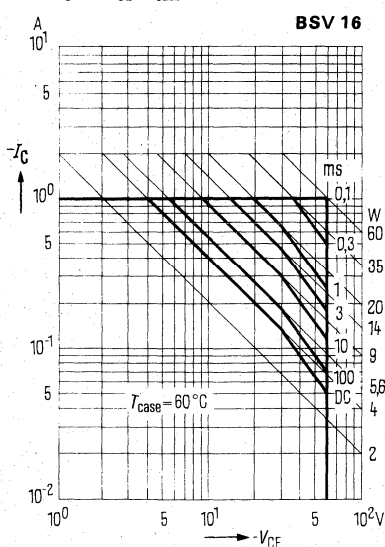

Permissible operating range
 $I_C = f(V_{CE}); T_{case} = 125^\circ C$

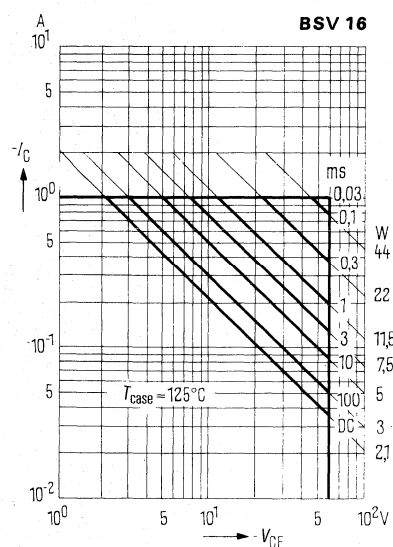

The permissible operating ranges apply to single pulses ($v = 0$). For pulse sequences the power dissipation has to be reduced in accordance with the diagram "permissible pulse load".

Permissible operating range
 $I_C = f(V_{CE}); T_{case} = 60^\circ C$

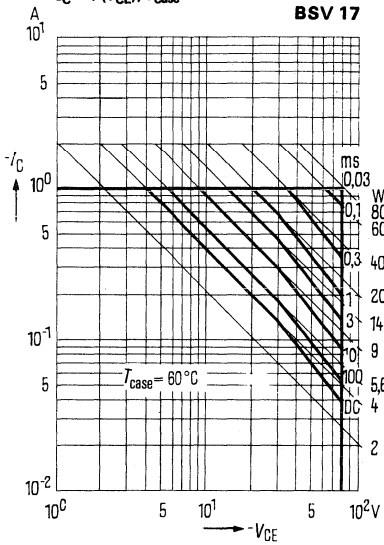

Permissible operating range
 $I_C = f(V_{CE}); T_{case} = 125^\circ C$

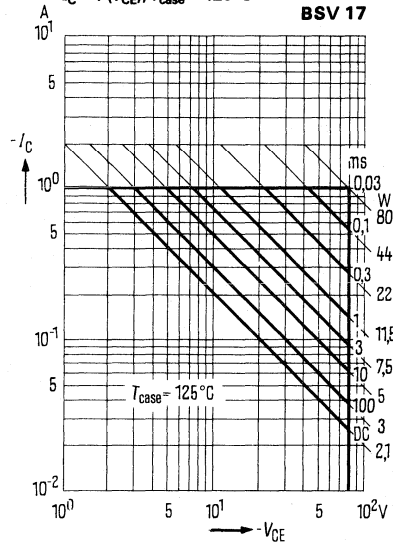

Collector current $I_C = f(V_{BE})$
 $-V_{CE} = 1V; T_{amb} = \text{parameter}$

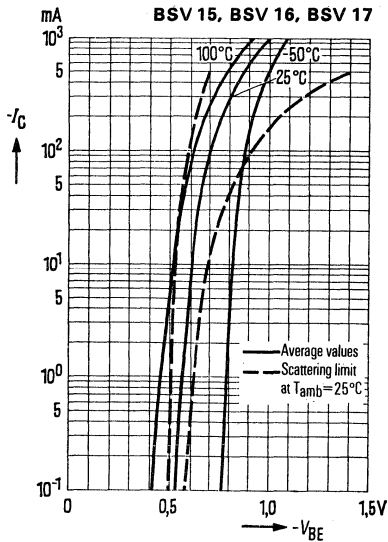

Output characteristics $I_C = f(V_{CE})$
 $-I_B = \text{parameter}$

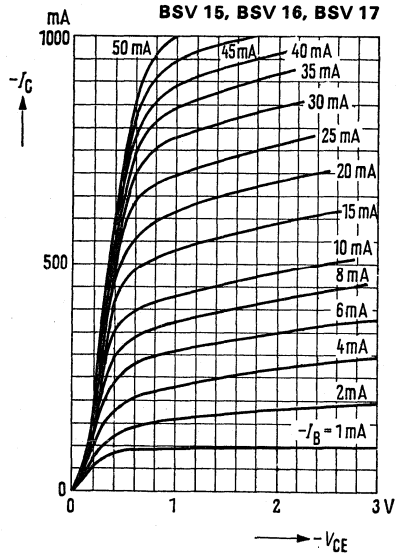

Collector-emitter saturation voltage

$-V_{CEsat} = f(I_C)$;
 $h_{FE} = 20, T_{amb} = \text{parameter}$

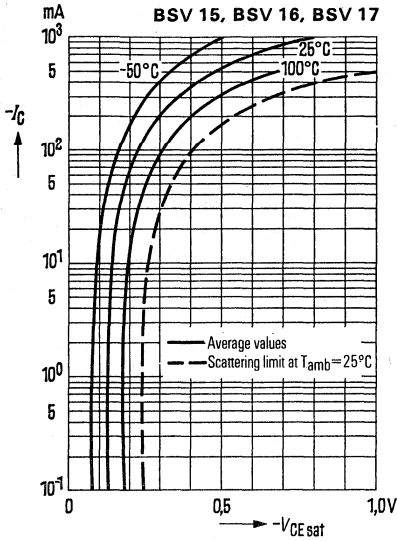

Base-emitter saturation voltage

$-V_{BEsat} = f(I_C)$;
 $h_{FE} = 20; T_{amb} = \text{parameter}$

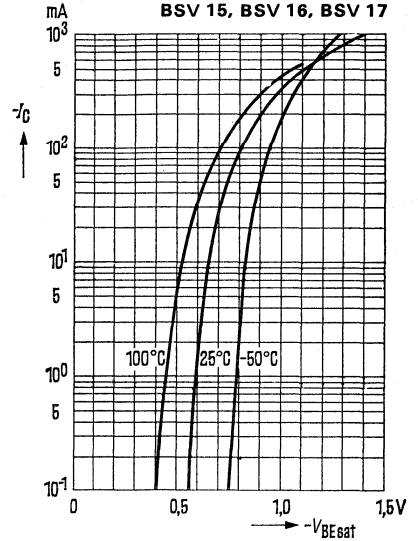

Collector cutoff current versus temperature
 $I_{CBO} = f(T_{amb})$

$-V_{CB} = 40\text{ V}$ **BSV 15**
 $-V_{CB} = 60\text{ V}$ **BSV 16**
 $-V_{CB} = 80\text{ V}$ **BSV 17**

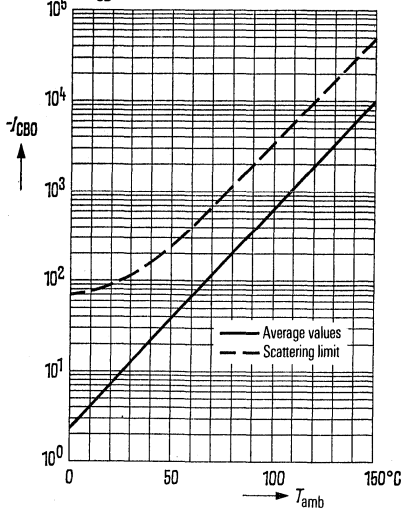

Transition frequency $f_T = f(I_C)$:
 $-V_{CE} \leq 10\text{ V}$ (Average value)

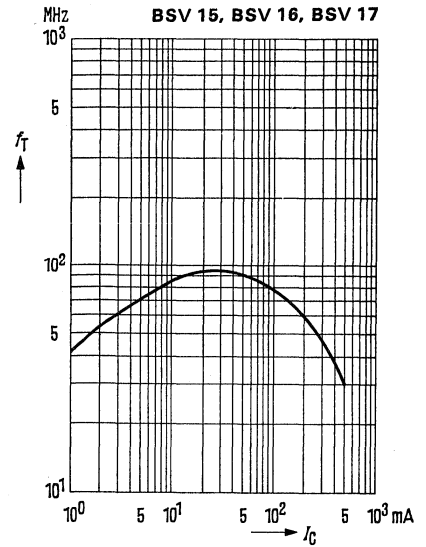

BSV 65 is an epitaxial NPN silicon planar switching transistor in TO 236 plastic package (23 A 3 DIN 41 869) designed for use in thick and thin film circuits.

It is particularly suitable for logic applications at the high packing density of microelectronic circuits and for hybrid units.

The type BSV 65 is marked with the code letter "F". The adjacent code letters A and B identify the DC current gain group. The transistor is also available upon request with changed terminal sequence (emitter and base terminal interchanged) under the designation BSV 65 R (mark "FY" and "FZ").

Type	Mark	Ordering code
BSV 65 ²⁾		Q62702-S355
BSV 65 A	FA	Q62702-S347
BSV 65 B	FB	Q62702-S348
BSV 65 R ²⁾		Q62702-S428
BSV 65 RA	FY	Q62702-S407
BSV 65 RB	FZ	Q62702-S406

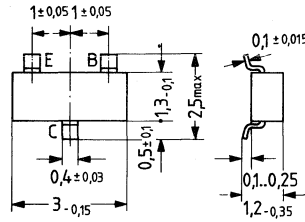

Approx. weight 0.02 g Dimensions in mm

Maximum ratings ($T_{amb} = 25\text{ °C}$)

Collector-emitter voltage	V_{CEO}	15	V
Collector-base voltage	V_{CBO}	20	V
Emitter-base voltage	V_{EBO}	5	V
Collector current	I_C	150	mA
Base current	I_B	30	mA
Junction temperature	T_j	150	°C
Storage temperature range	T_{stg}	-55 to +125	°C
Total power dissipation ($T_{amb} = 45\text{ °C}$) on glass substrate (7 x 7 x 1 mm)	P_{tot}	150 ¹⁾	mW

Thermal resistance

Junction to ambient air if mounted on

Glass substrate (7 x 7 x 1 mm)	R_{thJA}	≤ 700	K/W
Ceramic substrate (30 x 12 x 1 mm)	R_{thJA}	≤ 450	K/W
Glass-fiber substrate (30 x 12 x 1.5)	R_{thJA}	≤ 450	K/W

1) The permissible total power dissipation $P_{perm} \frac{T_{jmax} - T_{amb}}{R_{thJA}}$ is determined by the actual thermal resistance which depends on the installation.

2) In case of orders without an exact indication of the current amplification wanted, a transistor will be delivered of that current amplification group available at stock.

Static characteristics ($T_{amb} = 25^{\circ}\text{C}$)

DC current gain

($V_{CE} = 0.35\text{ V}$; $I_C = 10\text{ mA}$) group A (FA)

($V_{CE} = 0.35\text{ V}$; $I_C = 10\text{ mA}$) group B (FB)

Collector-emitter saturation voltage

($I_C = 10\text{ mA}$; $I_B = 1\text{ mA}$)

Base-emitter-saturation voltage

($I_C = 10\text{ mA}$; $I_B = 1\text{ mA}$)

Collector cutoff current ($V_{CBO} = 15\text{ V}$)

($V_{CBO} = 15\text{ V}$, $T_{amb} = 125^{\circ}\text{C}$)

Collector-emitter breakdown voltage

($I_{CEO} = 10\text{ mA}$)

Collector-base breakdown voltage ($I_{CBO} = 1\text{ }\mu\text{A}$)

Emitter-base breakdown voltage ($I_{EBO} = 10\text{ }\mu\text{A}$)

h_{FE}	40 to 300	-
h_{FE}	75 to 300	-
V_{CEsat}	<0.3	V
V_{BEsat}	<0.9	V
I_{CBO}	<500	nA
I_{CBO}	<30	μA
$V_{(BR)CEO}$	>15	V
$V_{(BR)CBO}$	>20	V
$V_{(BR)EBO}$	>5	V

Dynamic characteristics ($T_{amb} = 25^{\circ}\text{C}$)

Transition frequency

($V_{CE} = 10\text{ V}$; $I_C = 10\text{ mA}$; $f = 100\text{ MHz}$)

Collector-base capacitance ($V_{CBO} = 5\text{ V}$)

Switching times ($I_C = 10\text{ mA}$; $I_{B1} = 3\text{ mA}$;

$-I_{B2} = 1.5\text{ mA}$; $R_L = 270\text{ }\Omega$)

Storage time ($I_C = I_{B1} = 10\text{ mA}$; $R_{CC} = 1\text{ k}\Omega$)

f_T	>280	MHz
C_{CBO}	<5	pF
t_{on}	<20	ns
t_{off}	<40	ns
t_s	<20	ns

Test circuit for turn-on and turn-off time measurements

Duty cycle <2%

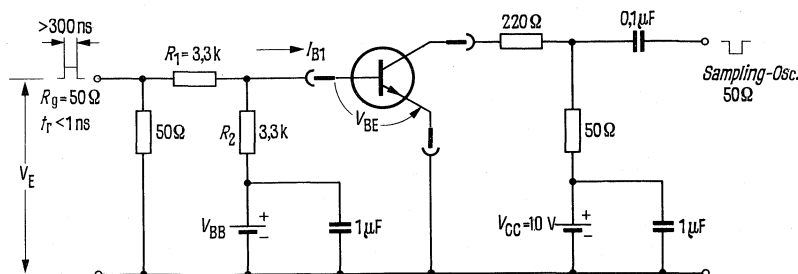

Test circuit for storage time measurement t_s

Duty cycle < 2%

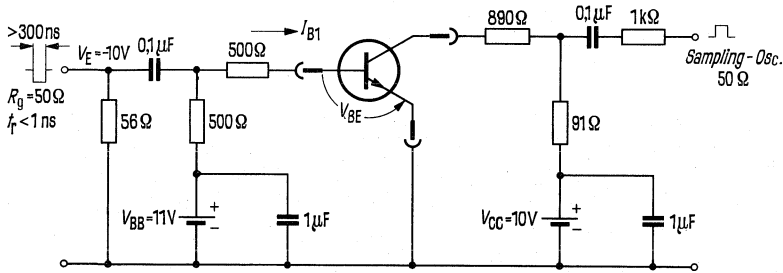

Total perm. power dissipation versus temperature

$P_{tot} = f(T_{amb})$

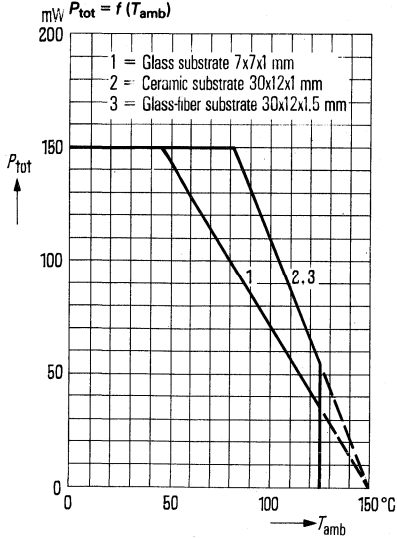

DC current gain $h_{FE} = f(I_C)$

$V_{CE} = 1 \text{ V}; T_{amb} = \text{parameter}$
(common emitter configuration)

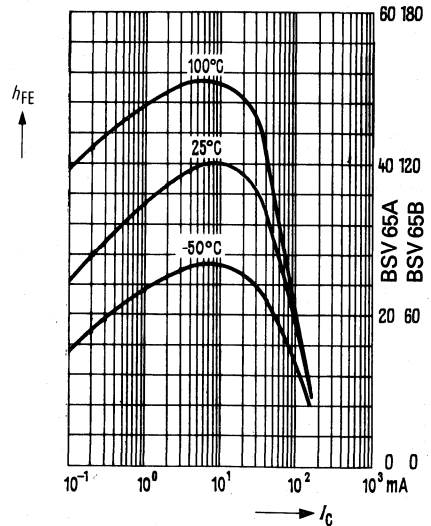

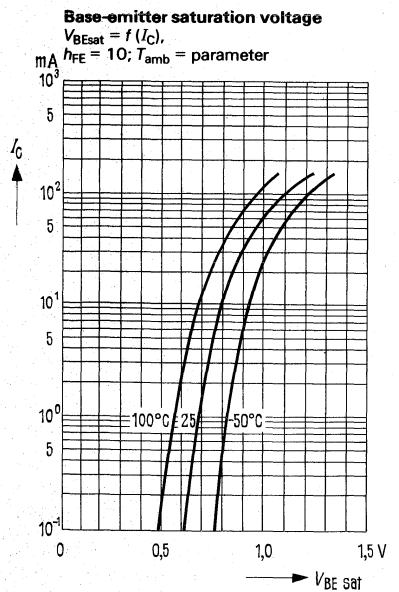
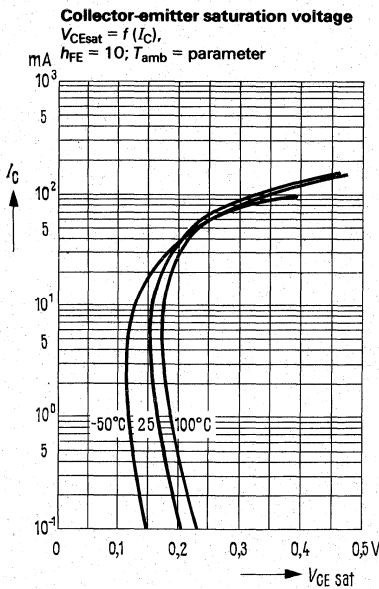
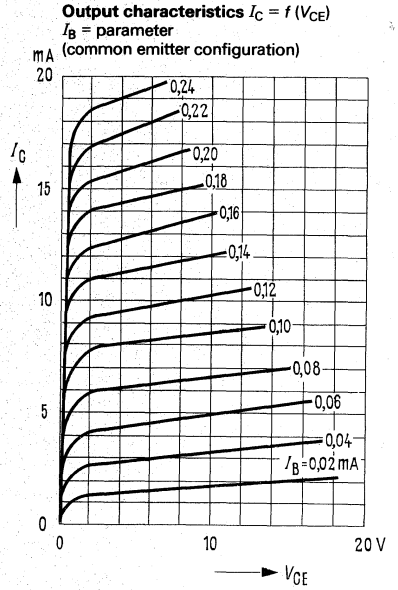
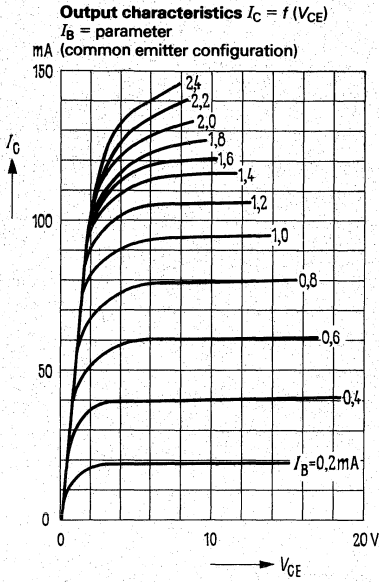

Collector-base capacitance

$C_{CBO} = f(V_{CBO})$

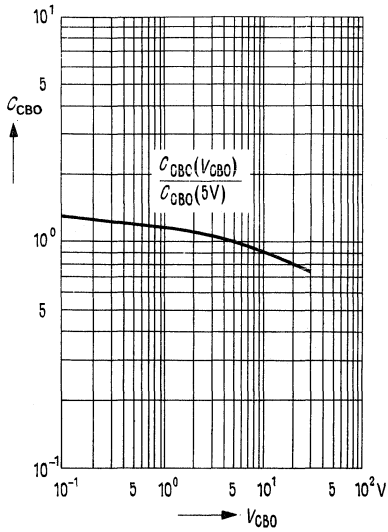

Collector cutoff current versus temperature

$I_{CBO} = f(T_{amb}); V_{CBO} = 25 V$

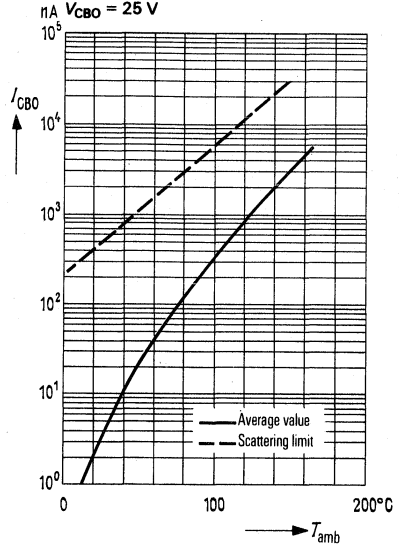

Collector current $I_C = f(V_{BE})$

$V_{CE} = 1 V$

(common emitter configuration)

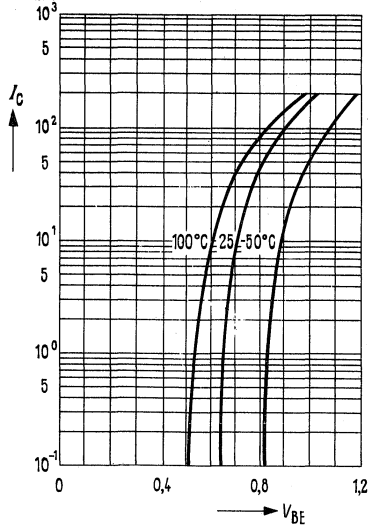

Transition frequency $f_T = f(I_C)$

$V_{CE} = 10 V; f = 100 MHz; T_{amb} = 25 °C$

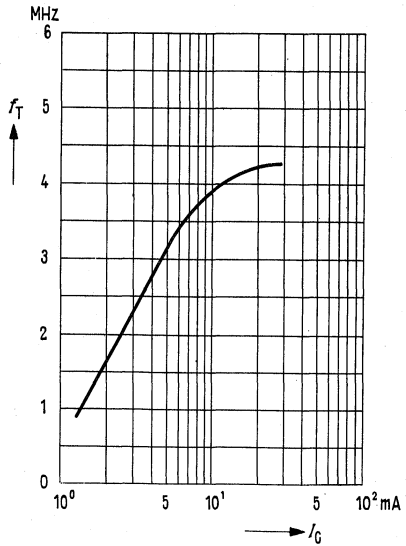

NPN Silicon Planar Transistors

BSX 45
BSX 46
BSX 47

BSX 45, BSX 46, and BSX 47 are epitaxial NPN silicon planar transistors in TO 39 case (5 C 3 DIN 41873). Their collectors are electrically connected to their cases. The transistors are particularly suitable for AF amplifiers and AF switching applications up to 1 A.

Type	Ordering code
BSX 45 ¹⁾	Q60218-X45
BSX 45-6	Q60218-X45-V6
BSX 45-10	Q60218-X45-V10
BSX 45-16	Q60218-X45-V16
BSX 46 ¹⁾	Q60218-X46
BSX 46-6	Q60218-X46-V6
BSX 46-10	Q60218-X46-V10
BSX 46-16	Q60218-X46-V16
BSX 47 ¹⁾	Q60218-X47
BSX 47-6	Q60218-X47-V6
BSX 47-10	Q60218-X47-V10

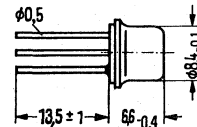

Approx. weight 1.5 g

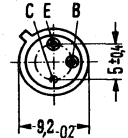

Dimensions in mm

Maximum ratings

	BSX 45	BSX 46	BSX 47		
Collector-emitter voltage	V_{CE0}	40	60	80	V
Collector-emitter voltage	V_{CES}	80	100	120	V
Emitter-base voltage	V_{EBO}	7	7	7	V
Collector current	I_C	1	1	1	A
Base current	I_B	0.2	0.2	0.2	A
Junction temperature	T_j	200	200	200	°C
Storage temperature range	T_{stg}		-65 to +200		°C
Total power dissipation ($T_{case} \leq 25^\circ\text{C}$)	P_{tot}	5	5	5	W

Thermal resistance

	R_{thJA}	R_{thJC}		
Junction to ambient air	≤ 200	≤ 200	≤ 200	K/W
Junction to case	≤ 35	≤ 35	≤ 35	K/W

Static characteristics ($T_{amb} = 25^\circ\text{C}$)

Transistors BSX 45, BSX 46, and BSX 47 are grouped according to their DC current gain h_{FE} at $I_C = 100$ mA and $V_{CE} = 1$ V. The different groups are marked by figures of the DIN-R 5 standard series.

Type	BSX 45 BSX 46 BSX 47	BSX 45 BSX 46 BSX 47	BSX 45 BSX 46 -	BSX 45 BSX 46 BSX 47
h_{FE} group	6	10	16	
I_C mA	h_{FE} I_C/I_B	h_{FE} I_C/I_B	h_{FE} I_C/I_B	V_{BE} V
0.1	28 (> 10)	40 (> 15)	90 (> 25)	-
100	63 (40 to 100)	100 (63 to 160)	160 (100 to 250)	< 1
500	25 (> 15)	40 (> 25)	60 (> 35)	0.75 to 1.5
1000	15	20	30	1.3 (< 2)

1) In case of orders without an exact indication of the current amplification wanted, a transistor will be delivered of that current amplification group available at stock.

Static characteristics ($T_{amb} = 25^{\circ}\text{C}$)		BSX 45	BSX 46	BSX 47	
Collector-emitter saturation voltage ($I_C = 1\text{ A}$; $h_{FE} = 10$)	V_{CEsat}	0.7 (<1)	0.7 (<1)	–	V
Collector-emitter saturation voltage ($I_C = 0.5\text{ A}$; $h_{FE} = 20$)	V_{CEsat}	–	–	0.5 (<0.9)	V
Collector cutoff current ($V_{CES} = 60\text{ V}$)	I_{CES}	1 (<30)	1 (<30)	–	nA
Collector cutoff current ($V_{CES} = 60\text{ V}$; $T_{amb} = 150^{\circ}\text{C}$)	I_{CES}	1 (<10)	1 (<10)	–	μA
Collector cutoff current ($V_{CES} = 80\text{ V}$)	I_{CES}	–	–	<30	nA
Collector cutoff current ($V_{CES} = 80\text{ V}$; $T_{amb} = 150^{\circ}\text{C}$)	I_{CES}	–	–	<10	μA
Collector cutoff current ($V_{CE} = 60\text{ V}$; $V_{BE} = 0.2\text{ V}$; $T_{amb} = 100^{\circ}\text{C}$)	I_{CEX}	<50	<50	–	μA
Collector cutoff current ($V_{CE} = 80\text{ V}$; $V_{BE} = 0.2\text{ V}$; $T_{amb} = 100^{\circ}\text{C}$)	I_{CEX}	–	–	<50	μA
Emitter cutoff current ($V_{EBO} = 5\text{ V}$)	I_{EBO}	<10	<10	<10	nA
Collector-emitter breakdown voltage ($I_{CE} = 50\text{ mA}$; pulse length = 200 μs ; duty cycle 1%)	$V_{(BR)CEO}$	>40	>60	>80	V
Collector-emitter breakdown voltage ($I_{CES} = 100\text{ }\mu\text{A}$)	$V_{(BR)CES}$	>80	>100	>120	V
Emitter-base breakdown voltage ($I_{EBO} = 100\text{ }\mu\text{A}$)	$V_{(BR)EBO}$	>7	>7	>7	V
Dynamic characteristics ($T_{amb} = 25^{\circ}\text{C}$)					
Transition frequency ($I_C = 50\text{ mA}$; $V_{CE} = 10\text{ V}$; $f = 20\text{ MHz}$)	f_T	>50	>50	>50	MHz
Collector-base capacitance ($V_{CBO} = 10\text{ V}$; $f = 1\text{ MHz}$)	C_{CBO}	<25	<20	<15	pF
Emitter-base capacitance ($V_{EBO} = 0.5\text{ V}$; $f = 1\text{ MHz}$)	C_{EBO}	<80	<80	<80	pF
Noise figure ($I_C = 100\text{ }\mu\text{A}$; $V_{CE} = 10\text{ V}$; $f = 1\text{ kHz}$; $\Delta f = 200\text{ Hz}$; $R_g = 1\text{ k}\Omega$)	NF	3.5	3.5	3.5	dB
Switching times $I_C = 100\text{ mA}$; I_{B1} approx. $-I_{B2}$ approx. 5 mA	t_{on} t_{off}	<200 <850	<200 <850	<200 <850	ns ns

BSX 45 BSX 46 BSX 47

Test circuit for switching times

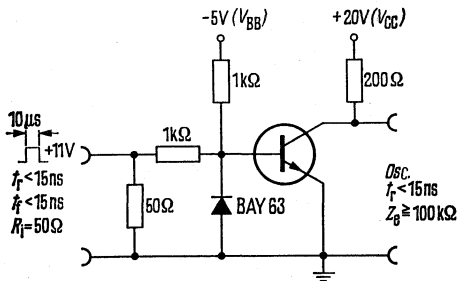

Total perm. power dissipation versus temperature

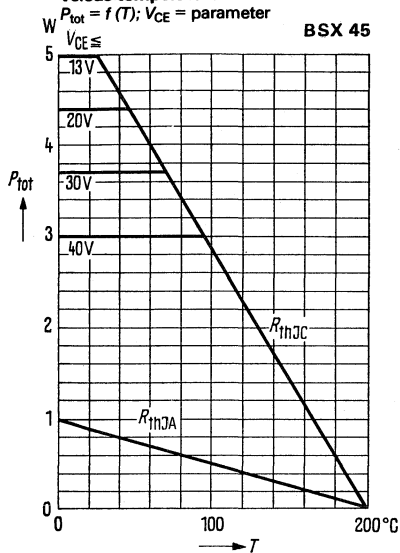

Total perm. power dissipation versus temperature

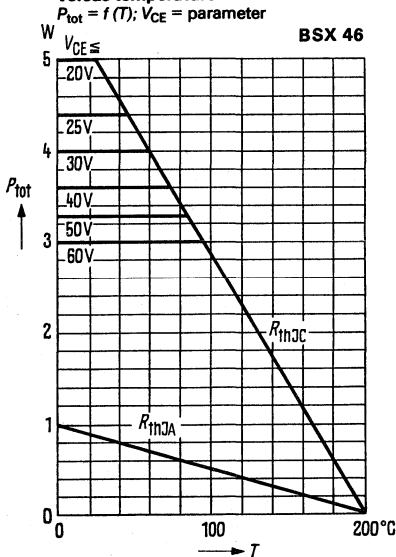

Total perm. power dissipation versus temperature

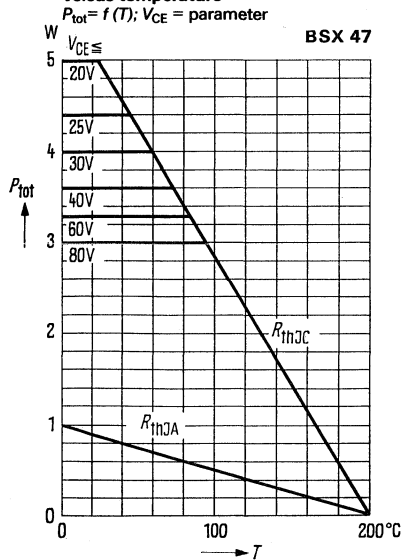

BSX 45
BSX 46
BSX 47

Permissible pulse load

K $r_{thJC} = f(t)$; $v = \text{parameter}$

BSX 45, BSX 46, BSX 47

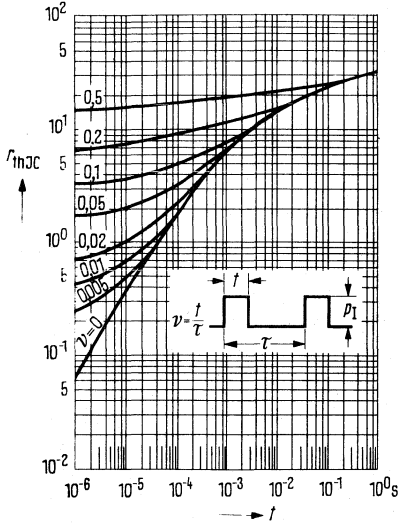

DC current gain $h_{FE} = f(I_C)$
 $V_{CE} = 1V$

BSX 45-6, BSX 46-6, BSX 47-6

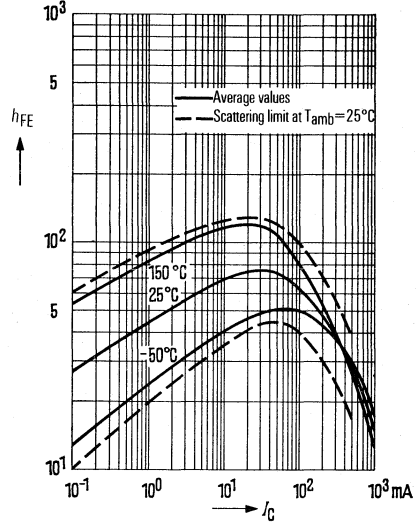

DC current gain $h_{FE} = f(I_C)$
 $V_{CE} = 1V$

BSX 45-10, BSX 46-10, BSX 47-10

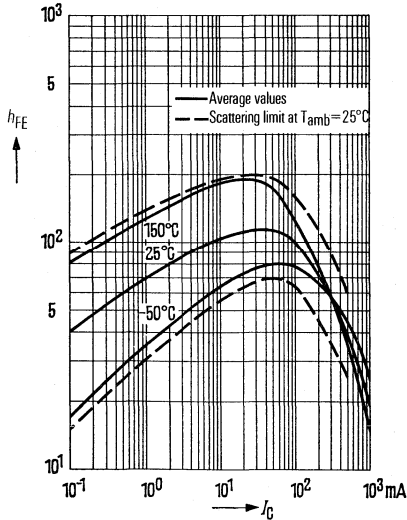

DC current gain $h_{FE} = f(I_C)$
 $V_{CE} = 1V$

BSX 45-16, BSX 46-16

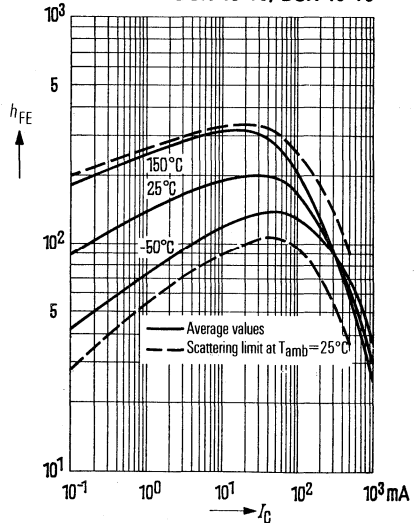

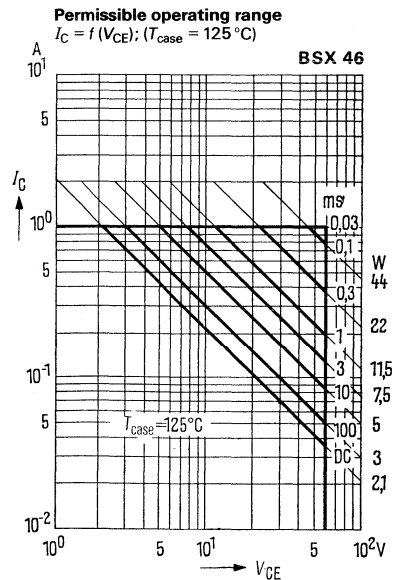
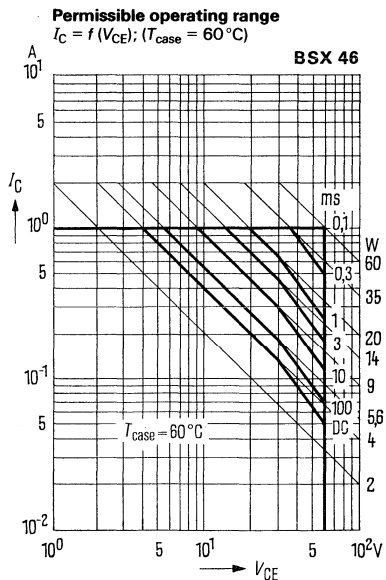
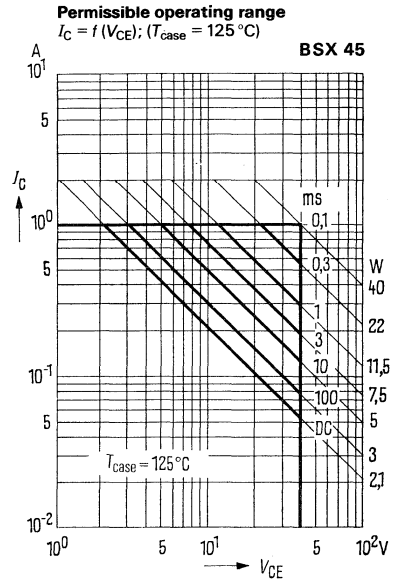
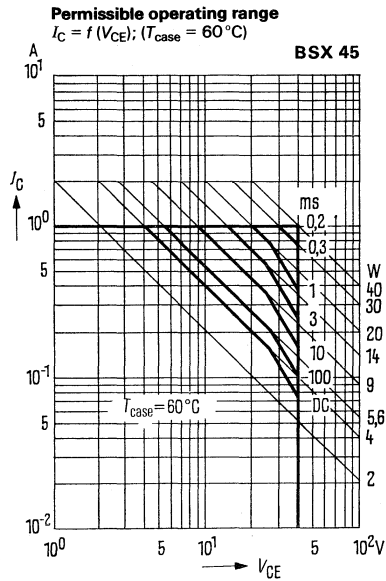

The permissible operating ranges apply to single pulses ($v = 0$). For pulse sequences the power dissipation has to be reduced in accordance with the diagram "permissible pulse load".

BSX 45
BSX 46
BSX 47

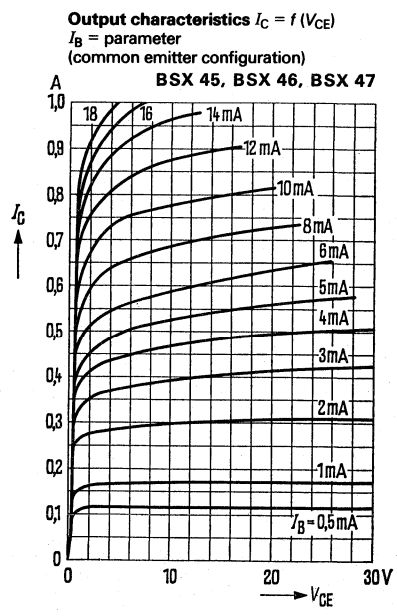
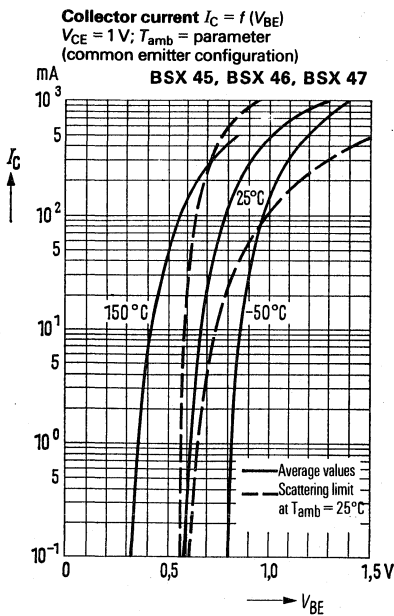
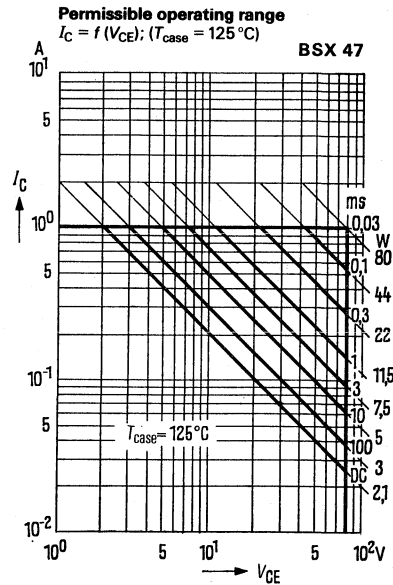
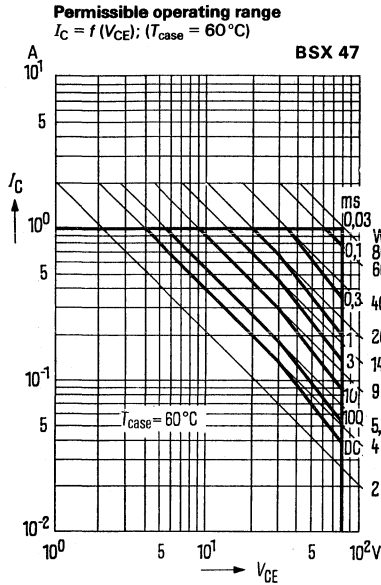

BSX 45
BSX 46
BSX 47

Output characteristics $I_C = f(V_{CE})$
 $I_B = \text{parameter}$
 (common emitter configuration)

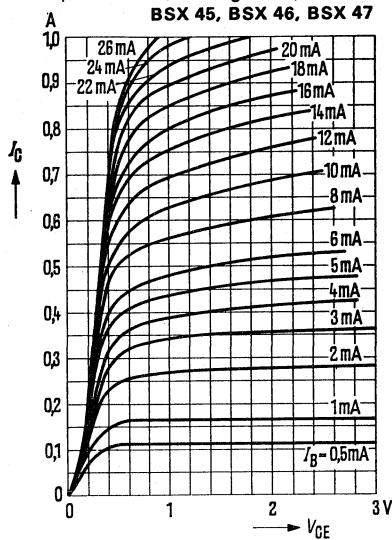

Output characteristics $I_C = f(V_{CE})$
 $I_B = \text{parameter}$
 (common emitter configuration)

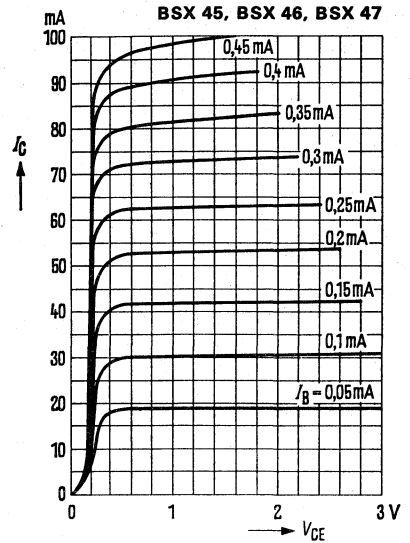

Saturation voltage $V_{CEsat} = f(I_C)$
 $h_{FE} = 10; T_{amb} = \text{parameter}$

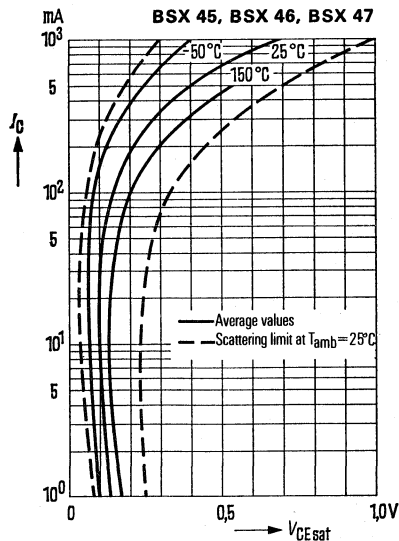

Saturation voltage $V_{BEsat} = f(I_C)$
 $h_{FE} = 10; V_{CE} = 1 \text{ V};$
 $T_{amb} = \text{parameter}$

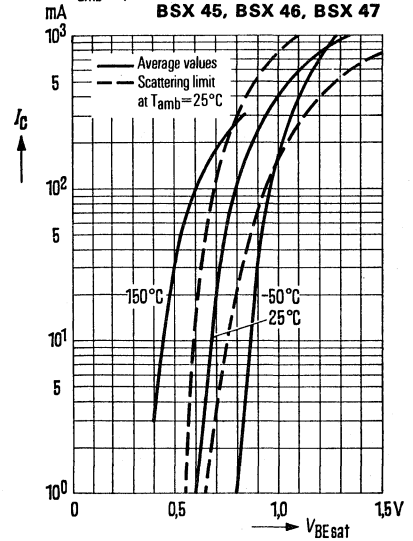

BSX 45
BSX 46
BSX 47

Collector cutoff current versus temperature $I_{CBO} = f(T_{amb})$

$V_{CB} = 60\text{ V}$ BSX 45, BSX 46
 $V_{CB} = 80\text{ V}$ BSX 47

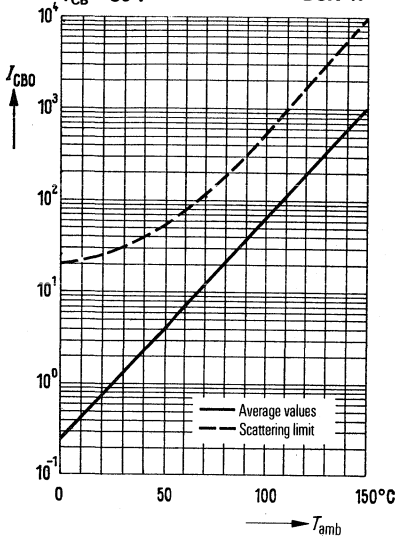

Transition frequency $f_T = f(I_C)$

$V_{CE} \leq 10\text{ V}$ BSX 45, BSX 46, BSX 47

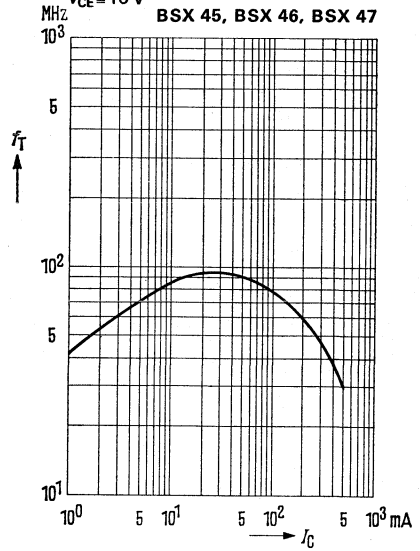

BSX 48 and BSX 49 are double diffused epitaxial silicon planar transistors in TO 18 case (18 A 3 DIN 41 876). Their collectors are electrically connected to the case.

The transistors are designed for use as high-speed switches and are particularly suitable for driving magnetic cores.

For data on the switching behavior of the transistors refer to the characteristics of the corresponding types BSY 34 and BSY 58.

Type	Ordering code
BSX 48	Q60218-X48
BSX 49	Q60218-X49

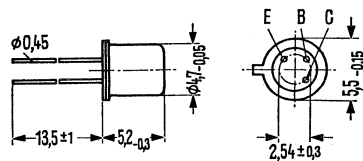

Approx. weight 0.3 g

Dimensions in mm

Maximum ratings

		BSX 48	BSX 49	
Collector-emitter voltage	V_{CE0}	25	40	V
Collector-emitter voltage	V_{CES}	50	60	V
Collector-base voltage	V_{CB0}	50	60	V
Emitter-base voltage	V_{EBO}	5	5	V
Collector current	I_C	600	600	mA
Base current	I_B	200	200	mA
Junction temperature	T_j	200	200	°C
Storage temperature range	T_{stg}	-65 to +200	-65 to +200	°C
Total power dissipation ($T_{case} \leq 45^\circ\text{C}$)	P_{tot}	1	1	W

Thermal resistance

Junction to ambient air	R_{thJA}	≤ 500	≤ 500	K/W
Junction to case	R_{thJC}	≤ 150	≤ 150	K/W

Static characteristics ($T_{amb} = 25^\circ\text{C}$)

At a collector emitter-voltage of $V_{CE} = 1\text{ V}$ and the following collector currents, the following values apply:

Type	BSX 48			BSX 49		
	$h_{FE} = I_C/I_B$	$V_{BEsat} V^{1)}$	$V_{CEsat} V^{1)}$	$h_{FE} = I_C/I_B$	$V_{BEsat} V^{1)}$	$V_{CEsat} V^{1)}$
1	23	0.62	—	23	0.62	—
10	37	0.70	—	37	0.70	—
100	42 (> 17)*	0.85	0.17	42 (> 25)*	0.85	0.17
500	25	1.2 (< 1.5)*	0.6 (< 1.5)*	25 (> 10)	1.2 (< 1.5)*	0.6 (< 1.0)*

1) The transistor is saturated to such an extent that the DC current gain decreases to $h_{FE} = 10$.

* AQL = 0.65%

Static characteristics ($T_{amb} = 25^{\circ}\text{C}$)

		BSX 48	BSX 49	
Collector cutoff current ($V_{CBO} = 50\text{ V}$)	I_{CBO}	< 120*	< 70*	nA
Collector-emitter breakdown voltage ($I_{CEO} = 10\text{ mA}$)	$V_{(BR)CEO}$	> 25	> 40	V
Collector-base breakdown voltage ($I_{CBO} = 100\text{ }\mu\text{A}$)	$V_{(BR)CBO}$	> 50	> 60	V
Emitter-base breakdown voltage ($I_{EBO} = 100\text{ }\mu\text{A}$)	$V_{(BR)EBO}$	> 5	> 5	V

Dynamic characteristics ($T_{amb} = 25^{\circ}\text{C}$)

Transition frequency ($I_C = 30\text{ mA}$; $V_{CE} = 10\text{ V}$; $f = 100\text{ MHz}$)	f_T	400 (> 250)	400 (> 250)	MHz
Collector-base capacitance ($V_{CBO} = 10\text{ V}$)	C_{CBO}	4.5 (< 6)	4.5 (< 6)	pF
Emitter-base capacitance ($V_{EBO} = 1\text{ V}$)	C_{EBO}	22	22	pF

Switching times:

Operating point:

$I_C = 150\text{ mA}$; $I_{B1} = 15\text{ mA}$;	t_{on}	35	30	ns
$-I_{B2} = 15\text{ mA}$; $R_L = 150\text{ }\Omega$	t_{off}	60	50	ns

Operating point:

$I_C = 500\text{ mA}$; $I_{B1} = 50\text{ mA}$;	t_{on}	35 (< 65)	30 (< 50)	ns
$-I_{B2} = 25\text{ mA}$; $V_E = 15\text{ V}$	t_{off}	65 (< 110)	65 (< 95)	ns
$R_L = 80\text{ }\Omega$ for BSX 49 ($V_{CC} = 40\text{ V}$)				
$R_L = 50\text{ }\Omega$ for BSX 48 ($V_{CC} = 25\text{ V}$)				

Test circuit for switching times

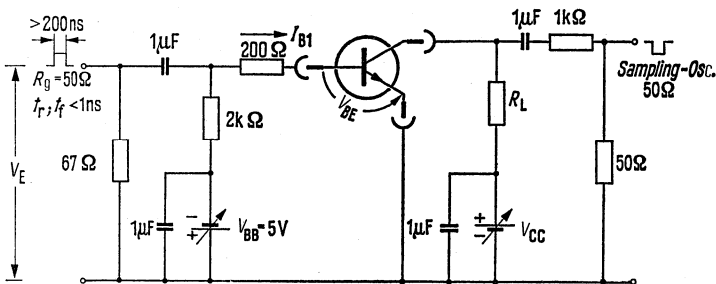

* AQL = 0.65%

Total perm. power dissipation versus temperature

$P_{tot} = f(T); R_{th} = \text{parameter}$

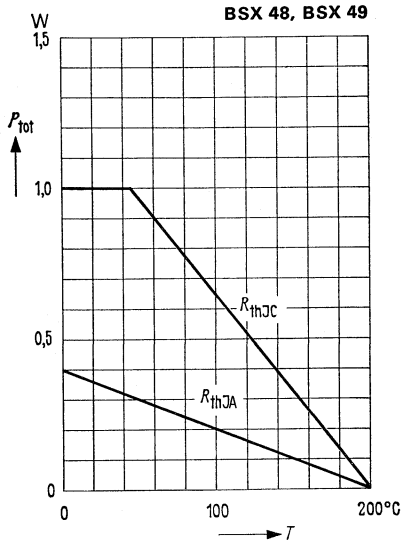

Collector current $I_C = f(I_B)$

$V_{CE} = 1\text{ V}$

(common emitter configuration)

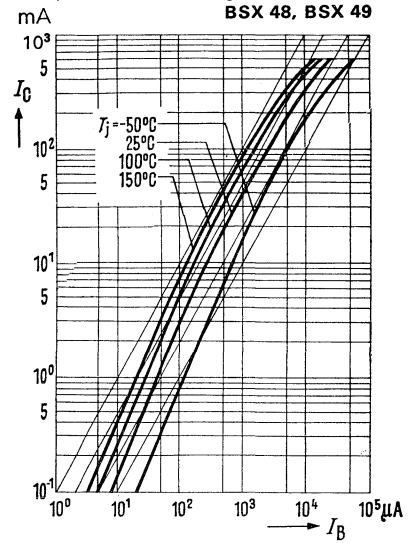

Output characteristics $I_C = f(V_{CE})$

$I_B = \text{parameter}$

(common emitter configuration)

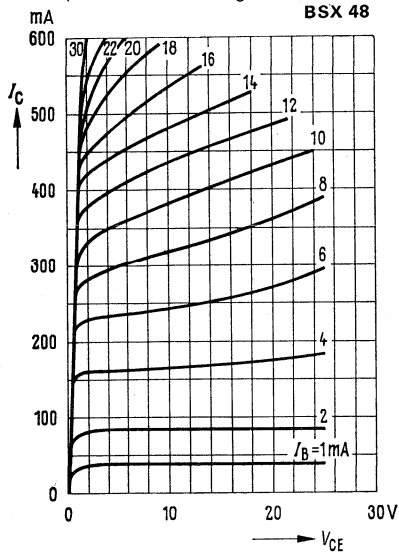

Output characteristics $I_C = f(V_{CE})$

$I_B = \text{parameter}$

(common emitter configuration)

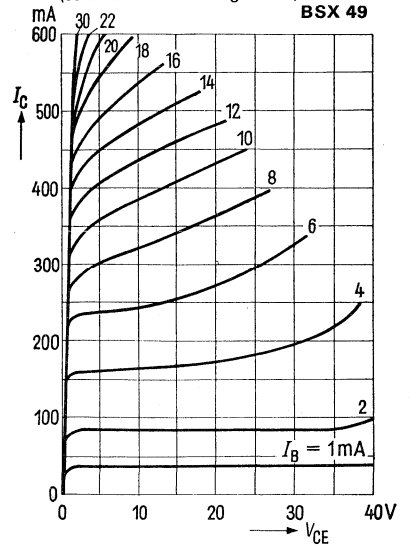

Input characteristics $I_B = f(V_{BE})$
 $V_{CE} = 1\text{ V}$
(common emitter configuration)

BSX 48, BSX 49

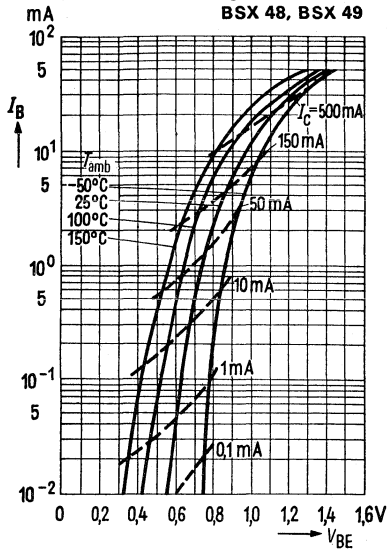

Collector-emitter saturation voltage $V_{CEsat} = f(I_C); h_{FE} = 10$
Base-emitter saturation voltage $V_{BEsat} = f(I_C); h_{FE} = 10$

BSX 48, BSX 49

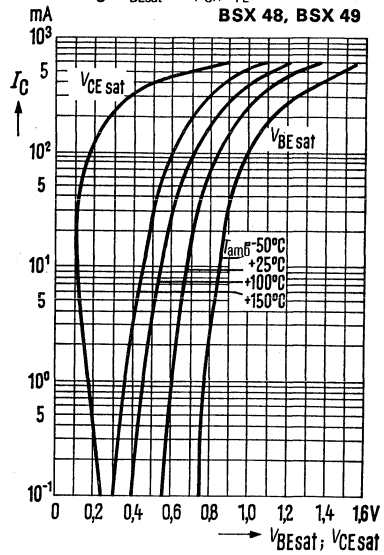

Collector cutoff current versus temperature $I_{CBO} = f(T_{amb})$
 $V_{CBO} = 50\text{ V}$

BSX 48, BSX 49

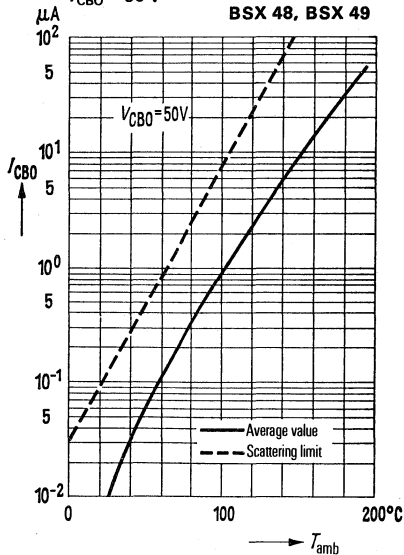

Collector-base capacitance $C_{CBO} = f(V_{CBO})$
Emitter-base capacitance $C_{EBO} = f(V_{EBO})$

BSX 48, BSX 49

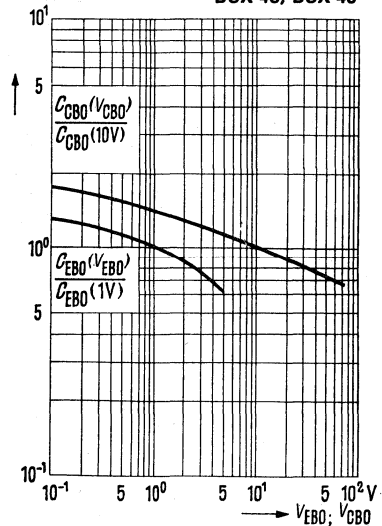

BSX 62 and BSX 63 are epitaxial NPN silicon planar transistors in TO 39 case (5 C 3 DIN 41873). The collector is electrically connected to the case. The transistors are particularly suitable for AF output stages and as a medium-power switch.

Type	Ordering code
BSX 62	Q60218-X62
BSX 62-6	Q60218-X62-B
BSX 62-10	Q60218-X62-C
BSX 62-16	Q60218-X62-D
BSX 63	Q60218-X63
BSX 63-6	Q60218-X63-B
BSX 63-10	Q60218-X63-C

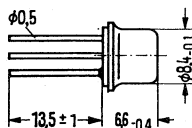

Approx. weight 1.5 g

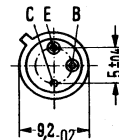

Dimensions in mm

Maximum ratings

		BSX 62	BSX 63	
Collector-emitter voltage	V_{CEO}	40	60	V
Collector-emitter voltage	V_{CES}	60	80	V
Emitter-base voltage	V_{EBO}	5	5	V
Collector current	I_C	3	3	A
Base current	I_B	500	500	mA
Junction temperature	T_j	200	200	°C
Storage temperature range	T_{stg}	-65 to +200	-65 to +200	°C
Total power dissipation ($T_{case} \leq 25^\circ\text{C}$)	P_{tot}	5	5	W

Thermal resistance

		BSX 62	BSX 63	
Junction to case	R_{thJC}	≤ 35	≤ 35	K/W
Junction to ambient air	R_{thJA}	≤ 200	≤ 200	K/W

Static characteristics ($T_{case} = 25^\circ\text{C}$)

Transistors BSX 62 and BSX 63 are grouped according to their DC current gain h_{FE} at $I_C = 1\text{ A}$ and $V_{CE} = 1\text{ V}$. The different groups are marked by figures of the DIN-R 5 series. Valid for the following operating points are:

Type	BSX 62			BSX 62, BSX 63			
	BSX 62	BSX 62	BSX 62				
h_{FE} group	6	10	16				
V_{CE} V	I_C A	h_{FE} I_C/I_B	h_{FE} I_C/I_B	h_{FE} I_C/I_B	V_{BE} V	$V_{CEsat}^{1)}$ V	$V_{BEsat}^{1)}$ V
1	0.1	70 (>30)	110	180	0.72 (<1)	-	-
1	1	63 (40 to 100)*	100 (63 to 160)*	160 (100 to 250)*	0.9 (<1.2)	-	-
5	2	40 (>25)	70	120	1.0 (<1.3)	-	-
	2	-	-	-	-	0.4 (<0.8)	1.0 (<1.3)
	2	-	-	-	-	0.2 (<0.7)	0.9 (<1.2)

1) The transistor is saturated to such an extent that the DC current gain decreases to $h_{FE} = 10$.

* AQL = 0.65%

Static characteristics ($T_{amb} = 25^{\circ}\text{C}$)

	BSX 62	BSX 63	
Collector cutoff current ($V_{CES} = 40\text{ V}$)	I_{CES}	10 (<100)*	nA
Collector cutoff current ($V_{CES} = 60\text{ V}$)	I_{CES}	–	nA
Collector cutoff current ($V_{CES} = 40\text{ V}; T_{case} = 150^{\circ}\text{C}$)	I_{CES}	10 (<100)*	nA
Collector cutoff current ($V_{CES} = 60\text{ V}; T_{case} = 150^{\circ}\text{C}$)	I_{CES}	–	μA
Collector-emitter breakdown voltage ($I_{CE} = 100\text{ mA}$; pulse length 200 μs ; duty cycle 1%)	$V_{(BR)CEO}$	>40	V
Emitter-base breakdown voltage ($I_{EB} = 10\text{ }\mu\text{A}$)	$V_{(BR)EBO}$	>5	V
Collector-base breakdown voltage ($I_{CB} = 100\text{ }\mu\text{A}$)	$V_{(BR)CBO}$	>60	V

Dynamic characteristics ($T_{case} = 25^{\circ}\text{C}$)

Transition frequency ($I_C = 200\text{ mA}; V_{CE} = 10\text{ V}$)	f_T	70 (>30)	70 (>30)	MHz
Collector-base capacitance ($V_{CB} = 10\text{ V}$)	C_{CB0}	35 (<70)	35 (<70)	pF
Switching times: (I_C approx. 1A; I_{B1} approx. $-I_{B2}$ approx. 50 mA)	t_{on}	<0.3	<0.3	μs
	t_{off}	<1.5	<1.5	μs

Test circuit for switching times

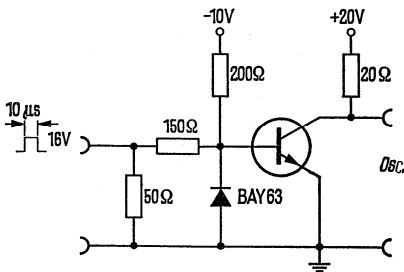

* AQL = 0.65%

Total perm. power dissipation versus temperature

$P_{tot} = f(T); R_{th} = \text{parameter}$

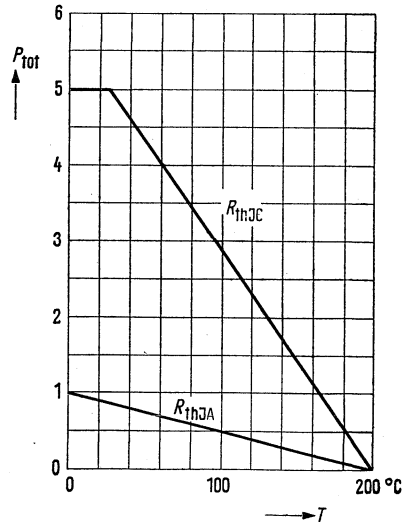

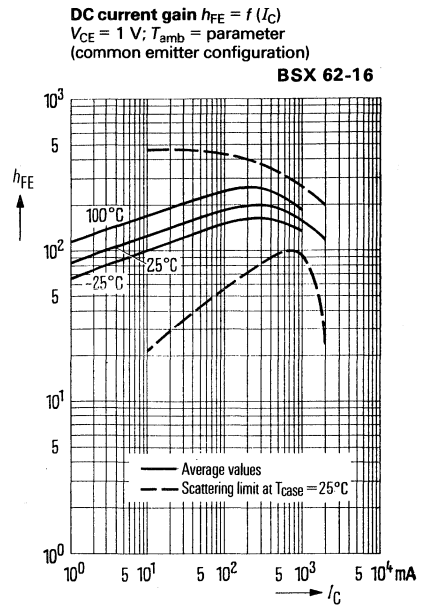
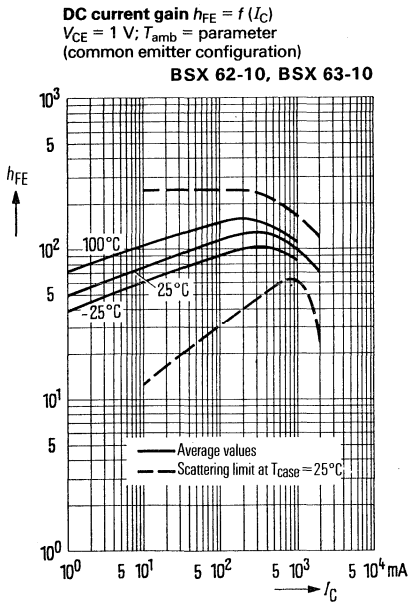
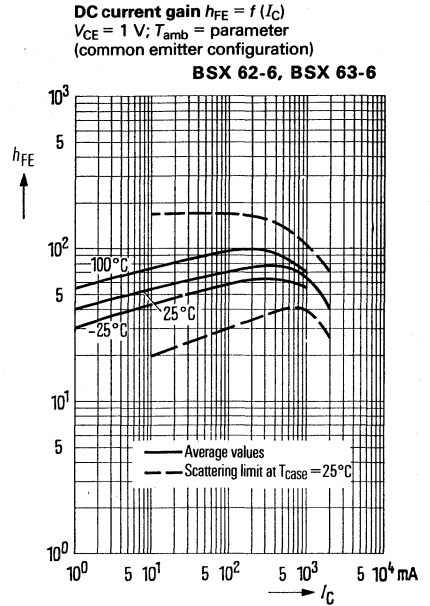
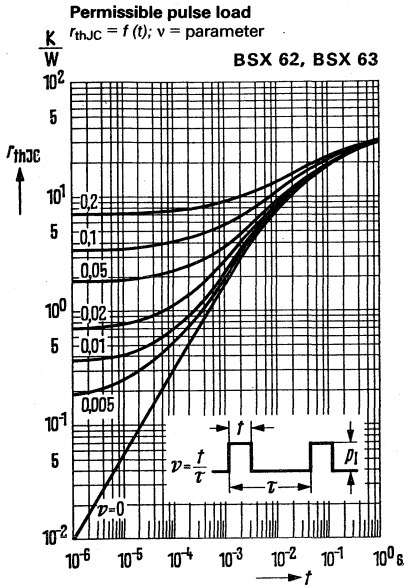

Output characteristics $I_C = f(V_{CE})$
 $I_B = \text{parameter}$
(common emitter configuration)

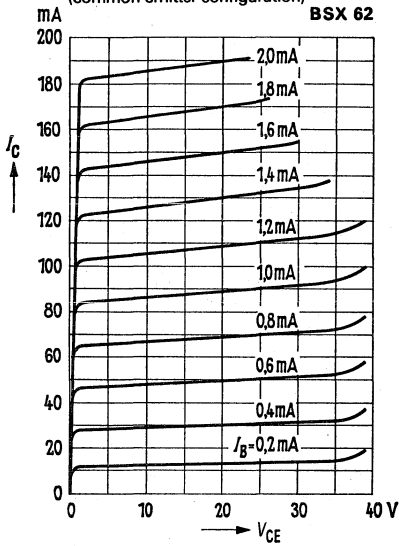

Output characteristics $I_C = f(V_{CE})$
 $I_B = \text{parameter}$
(common emitter configuration)

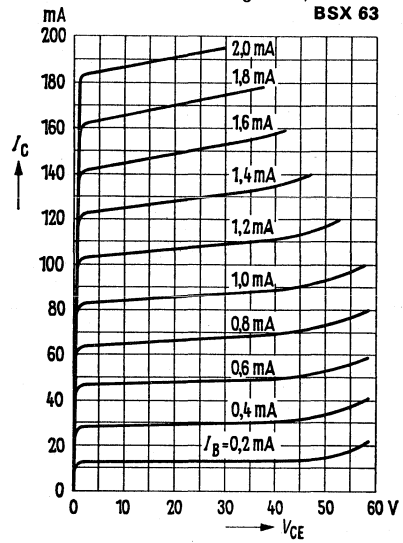

Output characteristics $I_C = f(V_{CE})$
 $I_B = \text{parameter}$
(common emitter configuration)

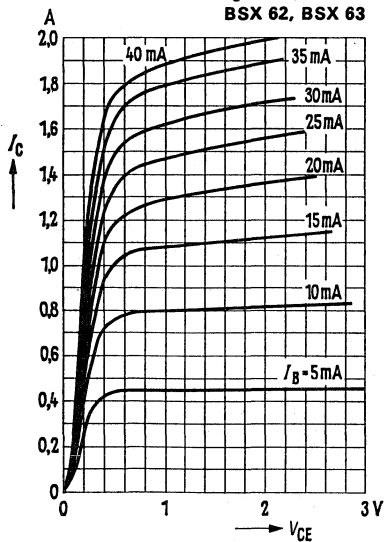

Collector-emitter saturation
voltage $V_{CEsat} = f(I_C)$
 $h_{FE} = 10$; $T_{amb} = \text{parameter}$
(common emitter configuration)

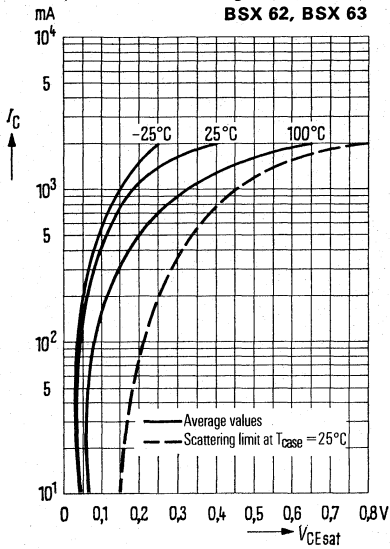

Collector-base saturation
voltage $V_{BEsat} = f(I_C)$
 $h_{FE} = 10$; $T_{amb} = \text{parameter}$
(common emitter configuration)

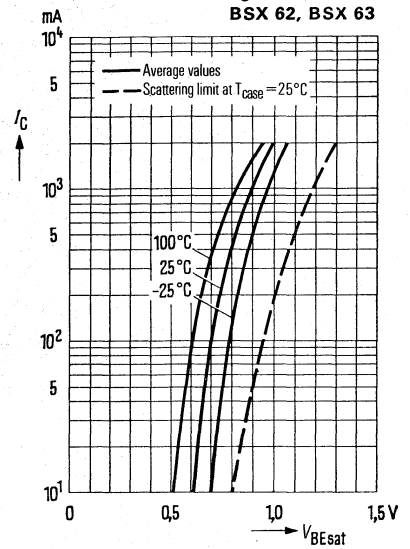

Collector cutoff current versus
temperature $I_{CBO} = f(T_{amb})$

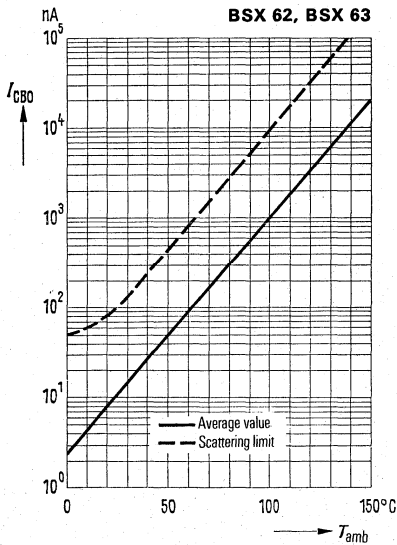

BSY 17, BSY 18, BSY 62, and BSY 63 are double-diffused epitaxial NPN silicon planar RF transistors in TO 18 case (18 A 3 DIN 41876). Their collectors are electrically connected to their cases. Transistor BSY 17 corresponds to type 2 N 743, BSY 18 to 2 N 744, BSY 62, group A, to type 2 N 706 A, and BSY 63 to type 2 N 708. The transistors are especially suitable for high-speed logic gate applications.

Type	Ordering code
BSY 17	Q60218-Y17
BSY 18	Q60218-Y18
BSY 62 A	Q60218-Y62-A
BSY 62 B	Q60218-Y62-B
BSY 63	Q60218-Y63

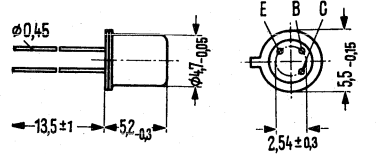

Approx. weight 0.3 g

Dimensions in mm

Maximum ratings

	BSY 17 BSY 18	BSY 62	BSY 63	
Collector-emitter voltage	V_{CEO} 12	15	15	V
Collector-base voltage	V_{CBO} 20	25	40	V
Emitter-base voltage	V_{EBO} 5	5	5	V
Collector current	I_C 200	200	200	mA
Junction temperature	T_j 200	200	200	°C
Storage temperature range	T_{stg}	-65 to +200		°C
Total power dissipation ($T_{case} = 45^\circ\text{C}$)	P_{tot} 1	1	1	W

Thermal resistance

Junction to ambient air	R_{thJA}	≤ 500	≤ 500	≤ 500	K/W
Junction to case	R_{thJC}	≤ 150	≤ 150	≤ 150	K/W

Static characteristics

Collector cutoff current ($V_{CBO} = 20\text{ V}$)
 Collector-emitter breakdown voltage
 ($I_{CEO} = 10\text{ mA}$)
 Emitter-base breakdown voltage
 ($I_{EBO} = 10\text{ }\mu\text{A}$)
 Collector-base breakdown voltage
 ($I_{CBO} = 1\text{ }\mu\text{A}$)

	BSY 17		
T_{amb}	170	25	°C
I_{CBO}	< 100	< 1*	μA
$V_{(BR)CEO}$	-	> 12	V
$V_{(BR)EBO}$	-	> 5*	V
$V_{(BR)CBO}$	-	> 20	V

* AQL = 0. 65%

Static characteristics

Collector cutoff current
 $(V_{CBO} = 20\text{ V})$
 Collector-emitter breakdown voltage
 $(I_{CEO} = 10\text{ mA})$
 Emitter-base breakdown voltage
 $(I_{EBO} = 10\text{ }\mu\text{A})$

Collector cutoff current
 $(V_{CBO} = 15\text{ V})$
 Collector-emitter breakdown voltage
 $(I_{CEO} = 10\text{ mA})$
 Emitter-base breakdown voltage
 $(I_{EBO} = 10\text{ }\mu\text{A})$
 Collector-base breakdown voltage
 $(I_{CBO} = 1\text{ }\mu\text{A})$

Collector cutoff current
 $(V_{CBO} = 20\text{ V})$
 Collector cutoff current
 $(V_{CE} = 20\text{ V}; V_{BE} = 0.25\text{ V};$
 $T_{amb} = 125^\circ\text{C})$
 Collector-emitter breakdown voltage
 $(I_{CEO} = 10\text{ mA})$
 Emitter-base breakdown voltage
 $(I_{EBO} = 10\text{ }\mu\text{A})$
 Collector-base breakdown voltage
 $(I_{CBO} = 1\text{ }\mu\text{A})$

* AQL = 0.65%

BSY 18			
T_{amb}	170	25	$^\circ\text{C}$
I_{CBO}	<100	<1*	μA
$V_{(BR)CEO}$	-	>12	V
$V_{(BR)EBO}$	-	>5*	V
BSY 62			
T_{amb}	150	25	$^\circ\text{C}$
I_{CBO}	<30	<0.5*	μA
$V_{(BR)CEO}$	-	>15	V
$V_{(BR)EBO}$	-	>5*	V
$V_{(BR)CBO}$	-	>25	V
BSY 63			
T_{amb}	150	25	$^\circ\text{C}$
I_{CBO}	<15	0.003	μA
I_{CEV}	<10	(<0.025)*	μA μA
$V_{(BR)CEO}$	-	>15	V
$V_{(BR)EBO}$	-	>5*	V
$V_{(BR)CBO}$	-	>40	V

Test circuit for turn-on and turn-off time measurements

Duty cycle <2%

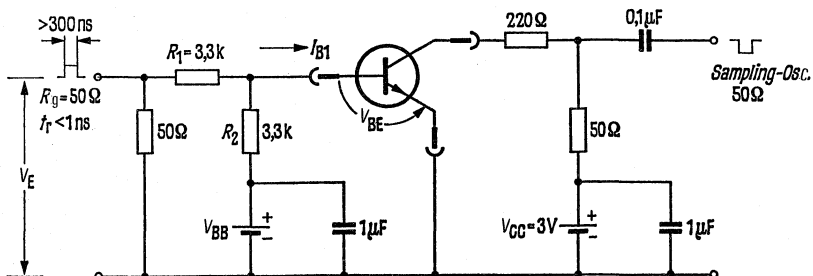

Static characteristics ($T_{amb} = 25^\circ\text{C}$)

BSY 17

V_{CE} V	I_B mA	I_C mA	h_{FE} I_C/I_B	$V_{BEsat}^{1)}$ V	$V_{CEsat}^{1)}$ V
0.25	<0.1	1	>10*	0.65	-
0.35	0.167 to 0.5	10	20 to 60*	0.7 (<0.85)	<0.28*
1.0	<10	100	>10*	<1.5	-

BSY 18

V_{CE} V	I_B mA	I_C mA	h_{FE} I_C/I_B	$V_{BEsat}^{1)}$ V	$V_{CEsat}^{1)}$ V
0.25	<0.05	1	>20*	0.66	-
0.35	0.083 to 0.25	10	40 to 120*	0.7 (<0.85)	<0.28*
1.0	<5.0	100	>20*	<1.5	-

BSY 62 The transistors are grouped according to the DC current gain h_{FE} and identified by the code letters "A" or "B".

h_{FE} group	V_{CE} V	I_B mA	I_C mA	h_{FE} I_C/I_B
A	1	0.17 to 0.5	10	20 to 60*
B	1	0.033 to 0.33	10	30 to 300*

Saturation voltage ($I_C = 10\text{ mA}; I_B = 10\text{ mA}$) $V_{BEsat}^{1)} = <0.9\text{ V}$
 $V_{CEsat}^{1)} = <0.6^*\text{ V}$

BSY 63

V_{CE} V	I_B mA	I_C mA	h_{FE} I_C/I_B
1	<0.033	0.5	>15*
1	0.083 to 0.33	10	30 to 120*

Saturation voltage ($I_C = 10\text{ mA}; I_B = 1\text{ mA}$) $V_{BEsat}^{1)} = 0.72 (<0.8)\text{ V}$
 $V_{CEsat}^{1)} = <0.4^*\text{ V}$

Test circuit for storage time (t_s)

Duty cycle <2%

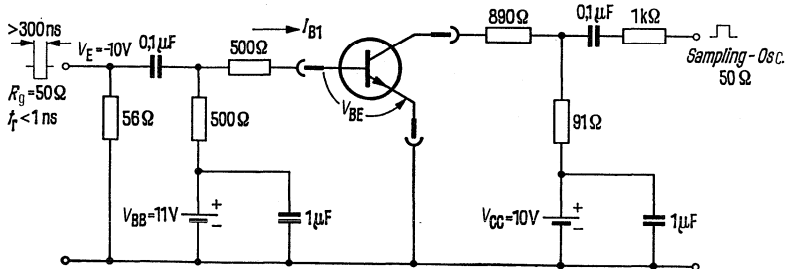

1) The transistor is saturated to such an extent that the DC current gain decreases to $h_{FE} = 10$.
 * AQL = 0.65%

Dynamic characteristics

($T_{amb} = 25^{\circ}\text{C}$)

Transition frequency

($I_C = 10\text{ mA}$; $V_{CE} = 10\text{ V}$;

$f = 100\text{ MHz}$)

Collector-base capacitance

($V_{CBO} = 5\text{ V}$)

	BSY 17	BSY 18	BSY 62	BSY 63	
f_T	> 280	> 280	> 280	> 300	MHz
C_{CBO}	2.7 (<5)	2.7 (<5)	2.7 (<5)	2.7 (<6)	pF

Switching times:

Operating point:

$I_C = 10\text{ mA}$; $I_{B1} = 3\text{ mA}$;

$-I_{B2} = 1.5\text{ mA}$; $R_L = 270\ \Omega$

t_{on}	< 16	< 16	< 40	< 40	ns
t_{off}	< 24	< 24	< 75	< 75	ns

Operating point:

$I_C = 100\text{ mA}$; $I_{B1} = 40\text{ mA}$;

$-I_{B2} = 20\text{ mA}$; $R_L = 50\ \Omega$

$I_C = I_{B1} = -I_{B2} = 10\text{ mA}$;

$R_L = 1\text{ k}\Omega$

t_{on}	7	7	-	-	ns
t_{off}	25	25	-	-	ns
t_{stg}	< 14	< 18	< 25	< 25	ns

Total perm. power dissipation versus temperature

$P_{tot} = f(T)$; R_{th} = parameter

BSY 17, BSY 18, BSY 62, BSY 63

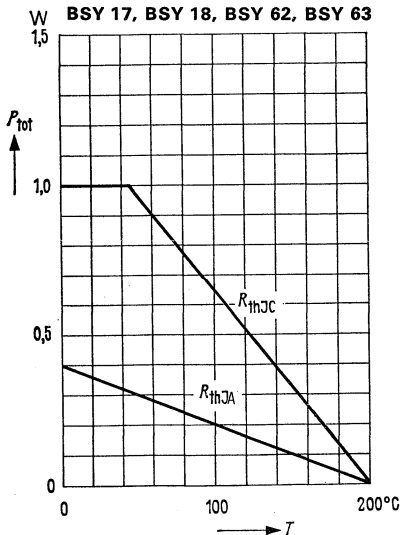

DC current gain $h_{FE} = f(I_C)$

$V_{CE} = 1\text{ V}$; T_{amb} = parameter

(common emitter configuration)

BSY 18, BSY 62A, BSY 62B

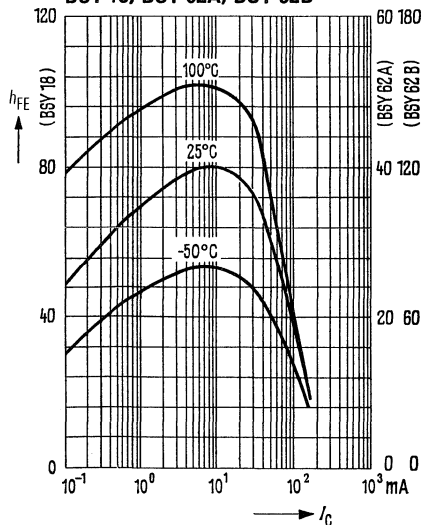

Output characteristics $I_C = f(V_{CE})$
 $I_B = \text{parameter}$
(common emitter configuration)

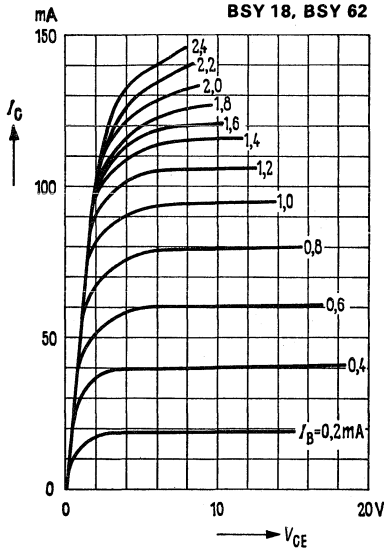

Output characteristics $I_C = f(V_{CE})$
 $I_B = \text{parameter}$
(common emitter configuration)

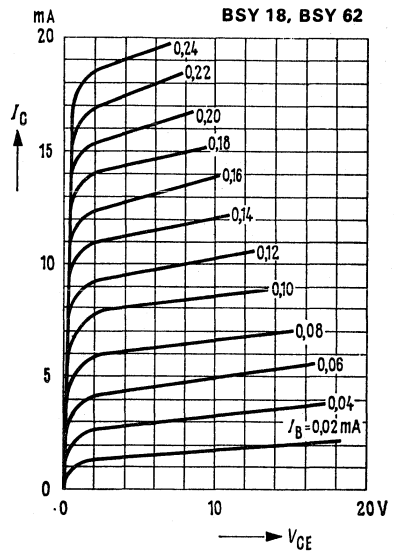

Collector-emitter saturation voltage
 $V_{CEsat} = f(I_C); h_{FE} = 10$
 $T_{amb} = \text{parameter}$

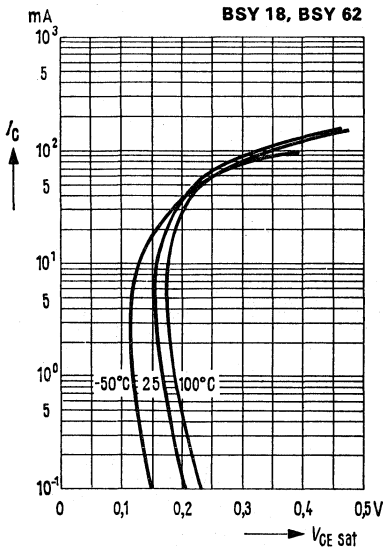

Base-emitter saturation voltage
 $V_{BEsat} = f(I_C); h_{FE} = 10$
 $T_{amb} = \text{parameter}$

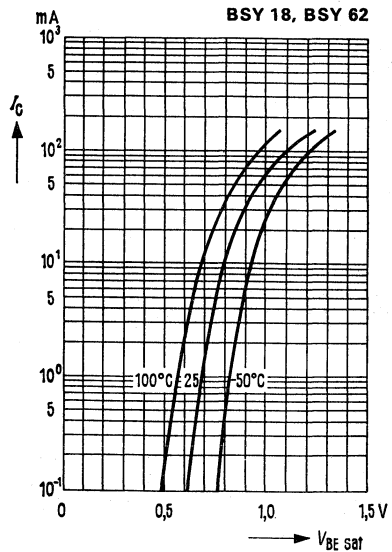

Collector current $I_C = f(V_{BE})$
 $V_{CE} = 1\text{ V}$
 (common emitter configuration)

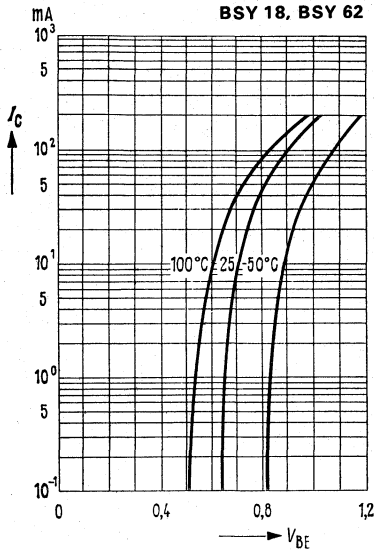

Transition frequency $f_T = f(I_C)$
 $V_{CE} = 10\text{ V}; f = 100\text{ MHz}; T_{\text{amb}} = 25^\circ\text{C}$

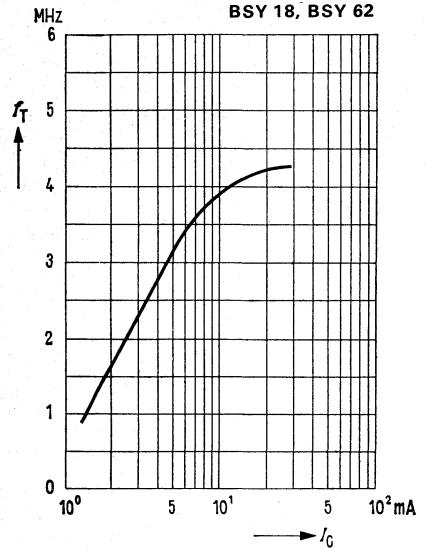

Collector cutoff current versus temperature
 $I_{CBO} = f(T_{\text{amb}}); V_{CBO} = 20\text{ V}$

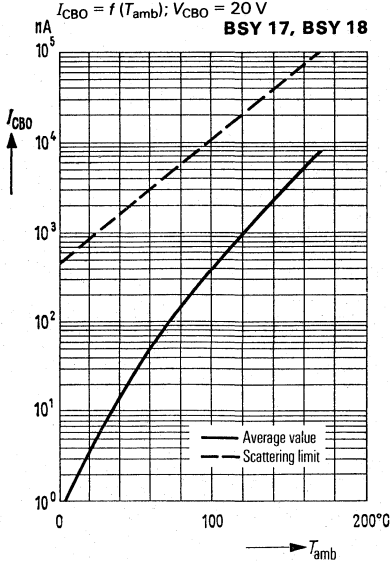

Collector cutoff current versus temperature
 $I_{CBO} = f(T_{\text{amb}}); V_{CBO} = 25\text{ V}$

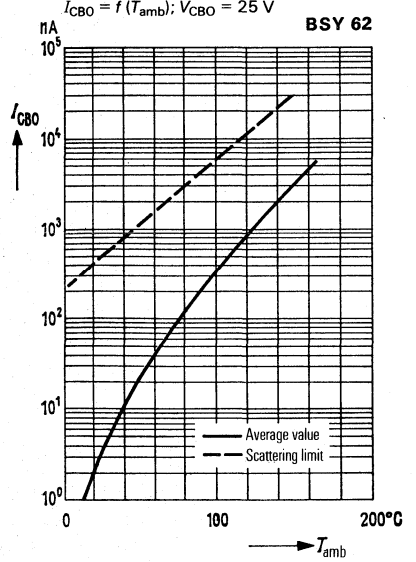

Collector-base capacitance

$C_R = f(V_{CBO})$

BSY 18, BSY 62

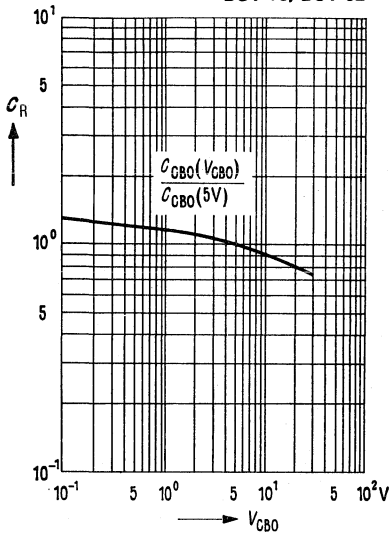

Turn-on time $t_{on} = f(h_{FE1})$

$I_C = 10 \text{ mA}; T_{amb} = 25^\circ\text{C}$

$V_{BB} = -3 \text{ V}; \frac{R_2}{R_1} = 1$

BSY 18

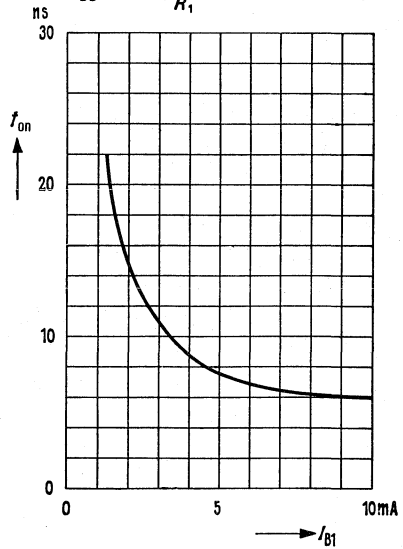

Turn-off time $t_{off} = f(I_{B1})$

$-I_{B2} = \text{parameter}$

$I_C = 10 \text{ mA}; T_{amb} = 25^\circ\text{C}$

BSY 18

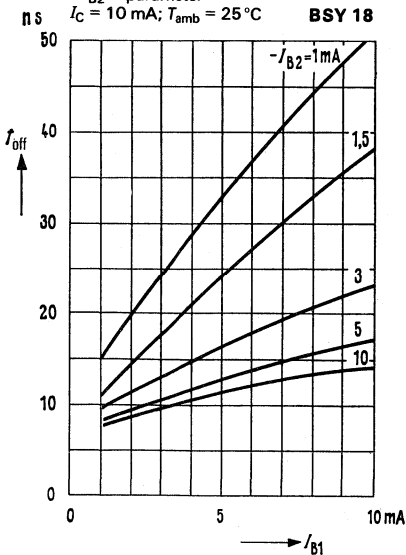

Storage time $t_s = f(I_{B1})$

$-I_{B2} = \text{parameter}$

$I_C = 10 \text{ mA}; T_{amb} = 25^\circ\text{C}$

BSY 18

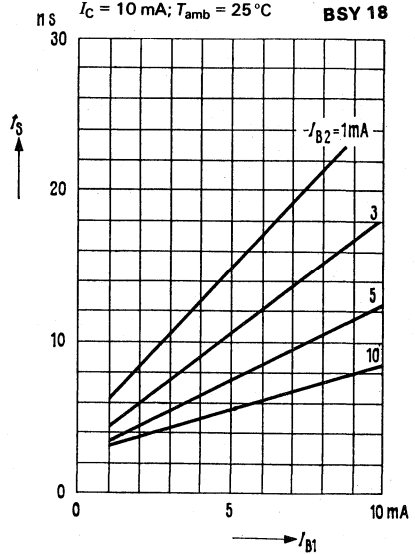

BSY 34 and BSY 58 are double diffused epitaxial NPN silicon planar transistors in TO 39 case (5 C 3 DIN 41 873). The collectors are electrically connected to the cases.

The transistors are intended for use as high-speed switches and in particular for driving magnetic cores.

Type	Ordering code
BSY 34	Q60218-Y34
BSY 58	Q60218-Y58

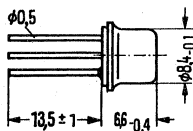

Approx. weight 1.5 g

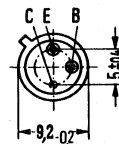

Dimensions in mm

Maximum ratings

		BSY 34	BSY 58	
Collector-emitter voltage	V_{CEO}	40	25	V
Collector-emitter voltage	V_{CES}	60	50	V
Collector-base voltage	V_{CBO}	60	50	V
Emitter-base voltage	V_{EBO}	5	5	V
Collector current	I_C	600	600	mA
Base current	I_B	200	200	mA
Junction temperature	T_j	200	200	°C
Storage temperature range	T_{stg}	-65 to +200	-65 to +200	°C
Total power dissipation ($T_{case} \leq 45^\circ\text{C}$)	P_{tot}	2.6	2.6	W

Thermal resistance

Junction to ambient air	R_{thJA}	≤ 220	≤ 220	K/W
Junction to case	R_{thJC}	≤ 60	≤ 60	K/W

Static characteristics ($T_{amb} = 25^\circ\text{C}$; $V_{CE} = 1\text{ V}$)

Type	BSY 34			BSY 58		
	h_{FE} I_C/I_B	$V_{BEsat}^{1)}$ V	$V_{CEsat}^{1)}$ V	h_{FE} I_C/I_B	$V_{BEsat}^{1)}$ V	$V_{CEsat}^{1)}$ V
1	23	0.62	—	23	0.62	—
10	37	0.7	—	37	0.7	—
100	42 (>25)*	0.85	0.17	42 (>17)*	0.85	0.17
500	25 (>10)	1.2 (<1.5)*	0.6 (<1)*	25	1.2 (<1.5)*	0.6 (<1.5)*

1) The transistor is saturated to such an extent that the DC current gain decreases to $h_{FE} = 10$.

* AQL = 0.65%

Static characteristics

	BSY 34		BSY 58	°C	
	T_{amb}	150	25		
Collector cutoff current ($V_{CBO} = 50\text{ V}$)	I_{CBO}	$< 7 \cdot 10^4$	$< 70^*$	$< 120^*$	nA
Collector-emitter breakdown voltage ($I_{CEO} = 10\text{ mA}$)	$V_{(BR)CEO}$		> 40	> 25	V
Collector-emitter breakdown voltage ($I_{CES} = 10\text{ }\mu\text{A}$)	$V_{(BR)CES}$		> 60	> 50	V
Collector-base breakdown voltage ($I_{CBO} = 100\text{ }\mu\text{A}$)	$V_{(BR)CBO}$		> 60	> 50	V
Emitter-base breakdown voltage ($I_{EBO} = 100\text{ }\mu\text{A}$)	$V_{(BR)EBO}$		> 5	> 5	V

Dynamic characteristics ($T_{amb} = 25^\circ\text{C}$)

Transition frequency ($I_C = 30\text{ mA}$; $V_{CE} = 10\text{ V}$; $f = 100\text{ MHz}$)	f_T		400 (> 250)	400 (> 250)	MHz
Collector-base capacitance ($V_{CBO} = 10\text{ V}$)	C_{CBO}		4.5 (< 6)	4.5 (< 6)	pF
Emitter-base capacitance ($V_{EBO} = 1\text{ V}$)	C_{EBO}		22	22	pF

Switching times

Operating point:

$I_C = 150\text{ mA}$; $I_{B1} = 15\text{ mA}$	t_{on}		30	35	ns
$-I_{B2} = 15\text{ mA}$; $R_L = 150\text{ }\Omega$	t_{off}		50	60	ns

Operating point:

$I_C = 500\text{ mA}$; $I_{B1} = 50\text{ mA}$; $-I_{B2} = 25\text{ mA}$; $V_E = 15\text{ V}$					
$R_L = 80\text{ }\Omega$ for BSY 34 ($V_{CC} = 40\text{ V}$)	t_{on}		30 (< 50)	35 (< 65)	ns
$R_L = 50\text{ }\Omega$ for BSY 58 ($V_{CC} = 25\text{ V}$)	t_{off}		65 (< 95)	65 (< 110)	ns

* AQL = 0.65%

Test circuit for switching times

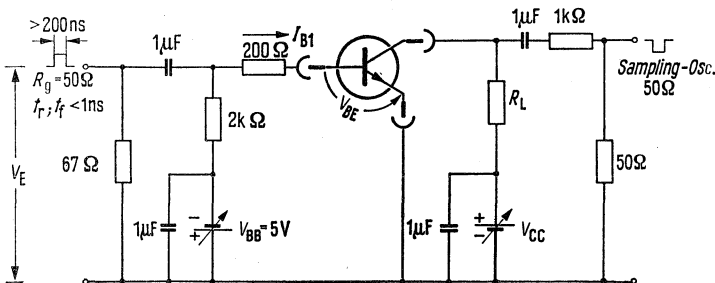

Total perm. power dissipation versus temperature
 $P_{tot} = f(T); R_{th} = \text{parameter}$

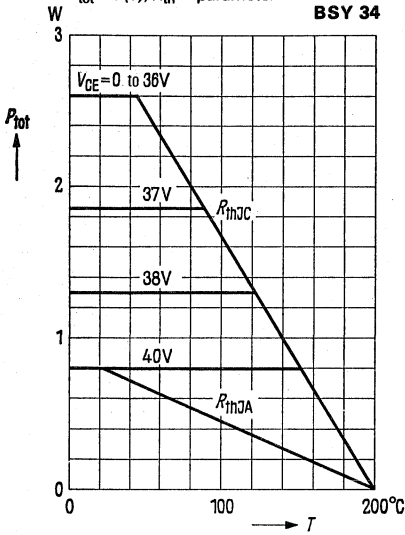

Total perm. power dissipation versus temperature
 $P_{tot} = f(T); R_{th} = \text{parameter}$

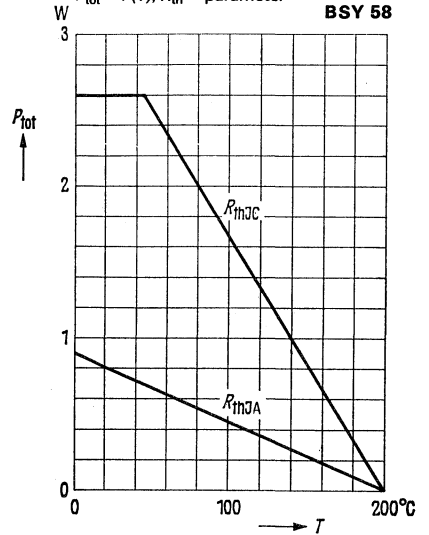

Permissible pulse load
 $r_{thJC} = f(t); v = \text{parameter}$

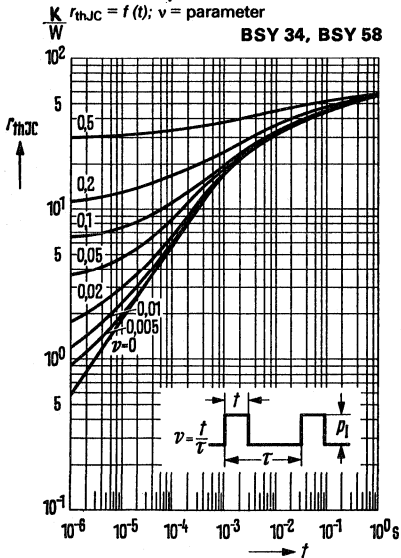

Output characteristics $I_C = f(V_{CE})$
 $I_B = \text{parameter}$
(common emitter configuration)

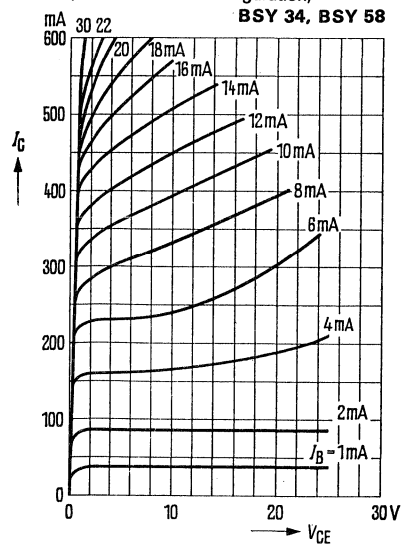

Collector cutoff current versus temperature $I_{CBO} = f(T_{amb})$
 $V_{CBO} = 60\text{ V}$

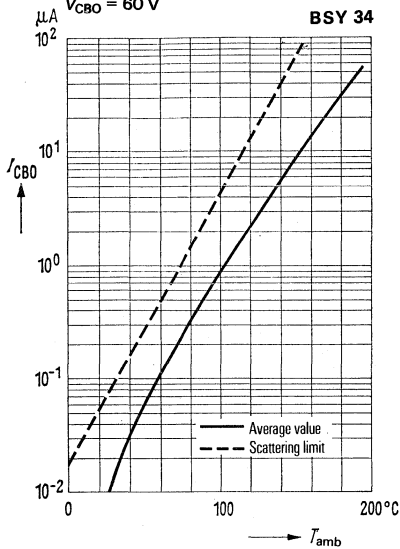

Collector cutoff current versus temperature $I_{CBO} = f(T_{amb})$
 $V_{CBO} = 50\text{ V}$

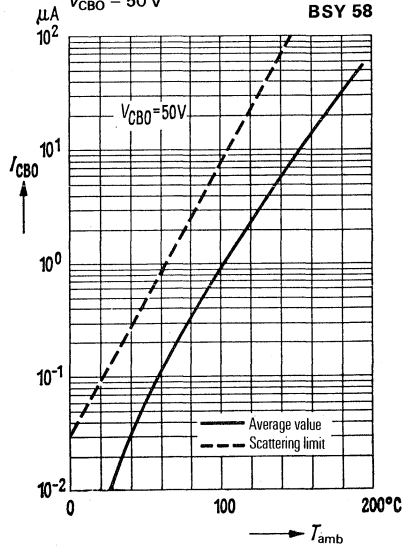

Collector current $I_C = f(I_B)$
 $V_{CE} = 1\text{ V}$
(common emitter configuration)

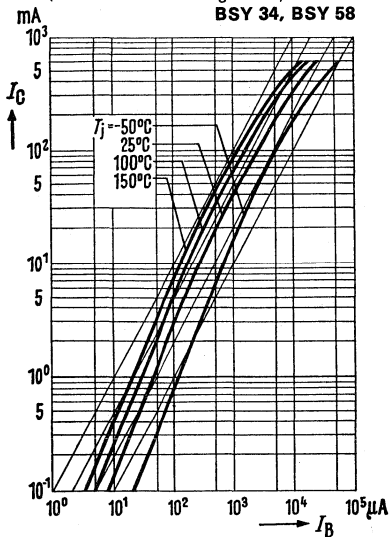

Input characteristics $I_B = f(V_{BE})$
 $V_{CE} = 1\text{ V}$
(common emitter configuration)

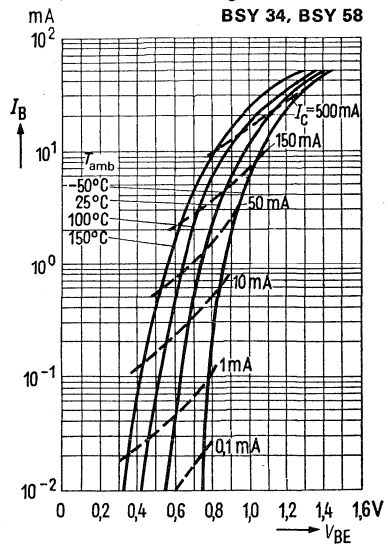

Collector-base capacitance
 $C_{CBO} = f(V_{CBO})$
Emitter-base capacitance
 $C_{EBO} = f(V_{EBO})$ **BSY 34, BSY 58**

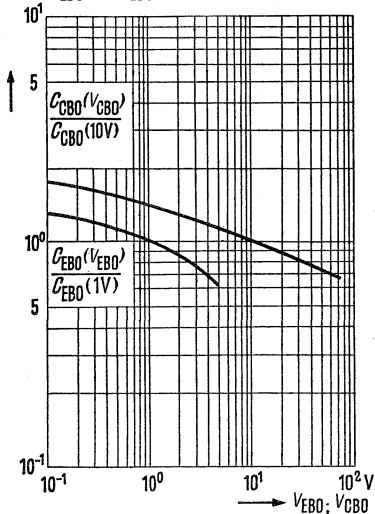

Saturation voltages
 $V_{CEsat} = f(I_C); h_{FE} = 10$
 $V_{BEsat} = f(I_C); h_{FE} = 10$

$T_{amb} = \text{parameter}$ **BSY 34, BSY 58**

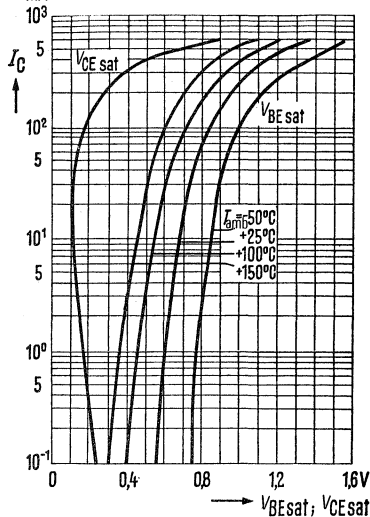

Delay time t_d
 $I_C = 150 \text{ mA}; V_{CC} = 40 \text{ V}$

BSY 34

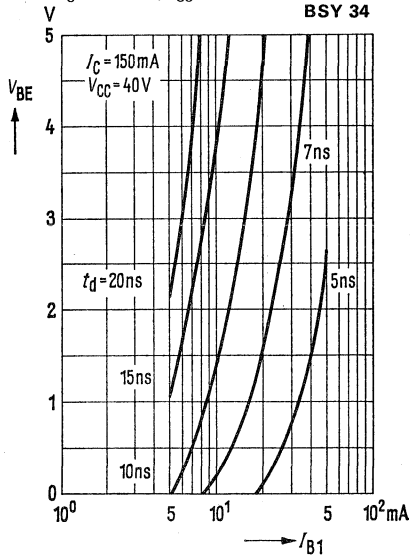

Rise time t_r
 $V_{CC} = 40 \text{ V}$

BSY 34

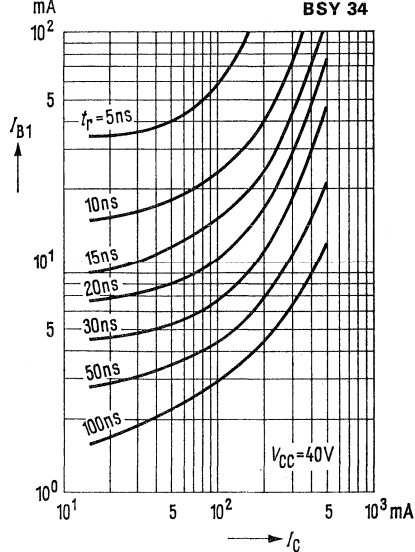

Storage time t_s
 $I_C = 50 \text{ mA}; V_{CC} = 40 \text{ V}$

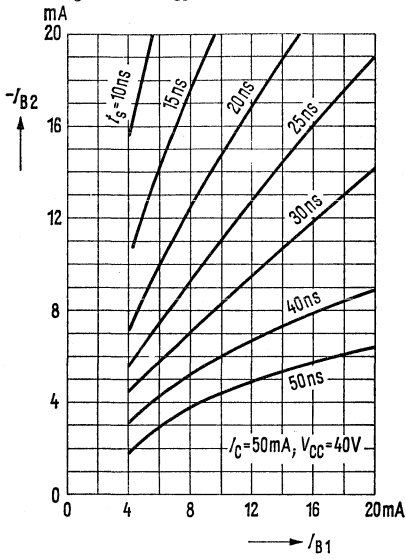

Fall time t_f
 $I_C = 50 \text{ mA}; V_{CC} = 40 \text{ V}$

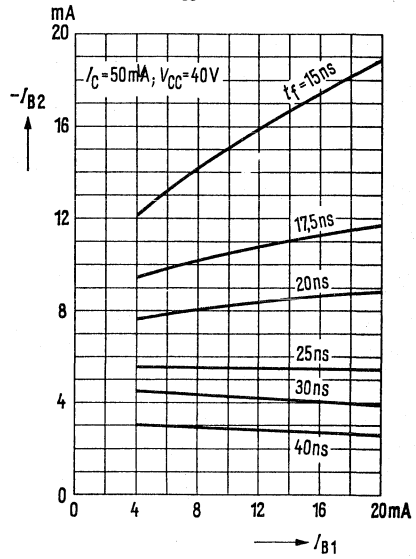

Storage time t_s
 $I_C = 150 \text{ mA}; V_{CC} = 40 \text{ V}$

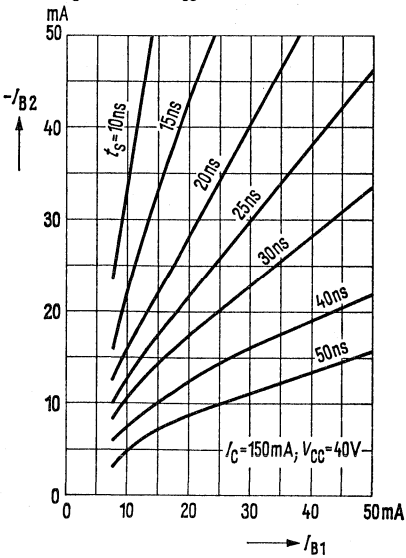

Fall time t_f
 $I_C = 150 \text{ mA}; V_{CC} = 40 \text{ V}$

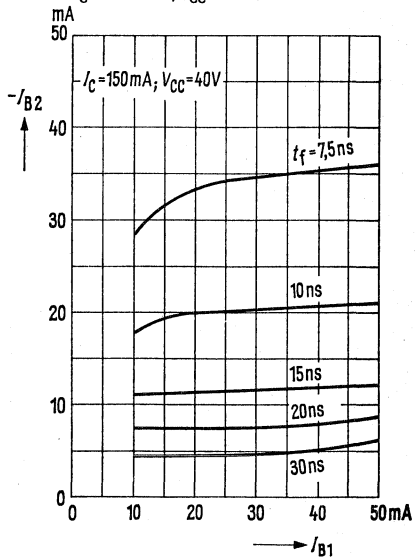

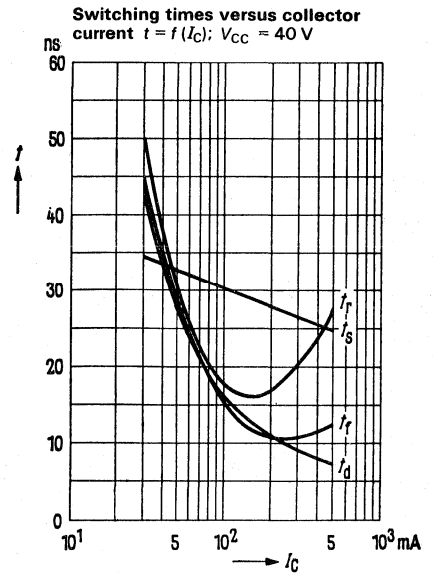
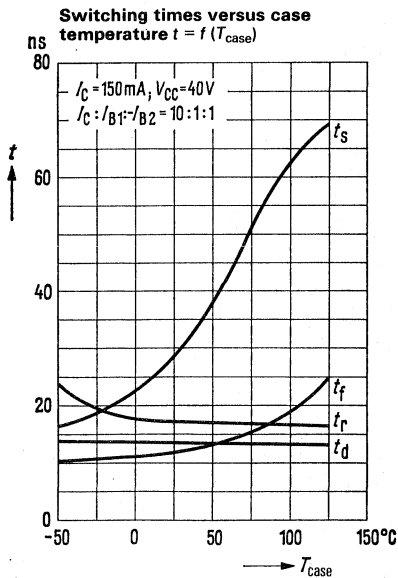
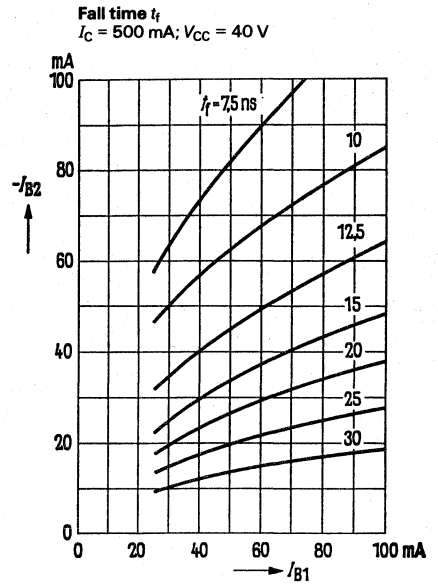
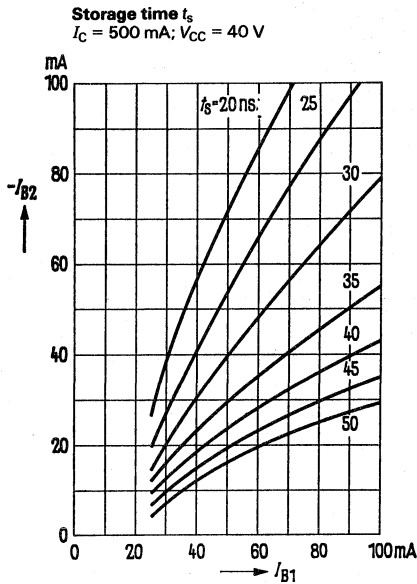

BU 205 is a triple diffused silicon NPN power switching transistor in a TO 3 case (3 B 2 DIN 41872). It is outstanding for short switching times and high dielectric strength. It is intended for use in horizontal deflection output stages for color TV receivers.

The collector is electrically connected to the case.

Type	Ordering code
BU 205	Q68000-A751

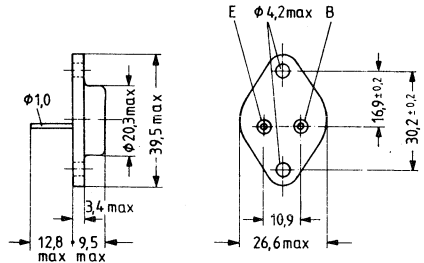

Approx. weight 18 g

Dimensions in mm

Maximum ratings

Collector-emitter voltage	V_{CES}	1500	V ¹⁾
Collector-emitter voltage ($R_{BE} < 100 \Omega$)	V_{CER}	1500	V
Collector-emitter voltage	V_{CEO}	700	V
Collector current	I_C	2.5	A
Collector peak current	I_{CM}	3	A ²⁾
Base peak current	I_{BM}	2.5	A
Negative base current	$-I_B$	0.1	A
Negative base peak current	$-I_{BM}$	1.5	A
Junction temperature	T_j	115	°C
Storage temperature range	T_{stg}	-65 to +115	°C
Total power dissipation ($T_{case} \leq 90^\circ C$)	P_{tot}	10	W

Thermal resistance

Junction to case	R_{thJC}	≤ 2.5	K/W
------------------	------------	------------	-----

1) Max. 1650 V are permitted in case of picture tube spark-overs.
 2) Max. 5 A are permitted in case of picture tube spark-overs.

Static characteristics

Collector cutoff current ($V_{CE} = 1500 \text{ V}$; $V_{BE} = 0$)	I_{CES}	≤ 1	mA
Emitter-base breakdown voltage ($I_E = 10 \text{ mA}$; $I_C = 0$)	$V_{(BR)EBO}$	≥ 5	V
($I_E = 100 \text{ mA}$; $I_C = 0$)	$V_{(BR)EBO}$	≥ 7	V
Collector-emitter breakdown voltage ($I_C = 100 \text{ mA}$; $I_B = 0$; $L = 25 \text{ mH}$)	$V_{(BR)CEO}$	≥ 700	V
Collector-emitter saturation voltage ($I_C = 2 \text{ A}$; $I_B = 1 \text{ A}$)	V_{CEsat}	≤ 5	V
Base-emitter saturation voltage ($I_C = 2 \text{ A}$; $I_B = 1 \text{ A}$)	V_{BEsat}	≤ 1.5	V
DC current gain ($V_{CE} = 5 \text{ V}$; $I_C = 2 \text{ A}$)	h_{FE}	> 2	—

Dynamic characteristics

Transition frequency ($V_{CE} = 5 \text{ V}$; $I_C = 0.1 \text{ A}$; $f = 5 \text{ MHz}$)	f_T	7.5	MHz
Collector-base capacitance ($V_{CB} = 10 \text{ V}$; $I_E = 0 \text{ A}$; $f = 1 \text{ MHz}$)	C_{CBO}	65	pF
Switching time: ($I_C = 2 \text{ A}$; $I_B = 1 \text{ A}$)	t_f	0.75	μs

BU 208 and BU 208 A are triple diffused silicon NPN power switching transistors in TO 3 case (3 B 2 DIN 41872). They are outstanding for short switching times and high dielectric strength and are intended for use in horizontal deflection output stages for color TV receivers. The collector is electrically connected to the case.

Type	Ordering code
BU 208	Q68000-A494
BU 208 A	Q68000-A5163

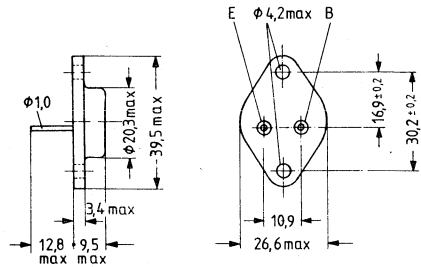

Approx. weight 18 g

Dimensions in mm

Maximum ratings

Collector-emitter voltage
($V_{BE} = 0$)
Collector-emitter voltage
Collector current
Collector peak current
Base peak current
Negative base current
Negative base peak current at turning off
Junction temperature
Storage temperature range
Total power dissipation ($T_{case} \leq 95^\circ\text{C}$)

	BU 208	BU 208 A	
V_{CESM}	1500	1500	V ¹⁾
V_{CEO}	700	700	V
I_C	5	5	A ²⁾
I_{CM}	7.5	7.5	A
I_{BM}	4	4	A
$-I_B$	0.1	0.1	A
$-I_{BM}$	2.5	2.5	A
T_j	115	115	°C
T_{stg}	-65 to +115		°C
P_{tot}	12.5	12.5	W

Thermal resistance

Junction to case	R_{thJC}	≤ 1.6	≤ 1.6	K/W
------------------	------------	------------	------------	-----

1) Max. 1650 V are permitted in case of picture tube spark-overs.
2) Max. 5 A are permitted in case of picture tube spark-overs.

Static characteristics

Collector cutoff current
($V_{CE} = 1500 \text{ V}$; $V_{BE} = 0$)
 Emitter-base breakdown voltage
($I_E = 10 \text{ mA}$; $I_C = 0$)
($I_E = 100 \text{ mA}$, $I_C = 0$)
 Collector-emitter breakdown voltage
($I_C = 100 \text{ mA}$, $I_B = 0$, $L = 25 \text{ mH}$)
 Collector-emitter saturation voltage
($I_C = 4.5 \text{ A}$, $I_B = 2 \text{ A}$)
 Base-emitter saturation voltage
($I_C = 4.5 \text{ A}$; $I_B = 2 \text{ A}$)
 DC current gain
($V_{CE} = 5 \text{ V}$, $I_C = 4.5 \text{ A}$)

	BU 208	BU 208 A	
I_{CES}	≤ 1	≤ 1	mA
$V_{(BR)EBO}$	≥ 5	≥ 5	V
$V_{(BR)EBO}$	≥ 7	≥ 7	V
$V_{(BR)CEO}$	≥ 700	≥ 700	V
V_{CEsat}	≤ 5	≤ 1	V
V_{BEsat}	≤ 1.5	≤ 1.5	V
h_{FE}	≥ 2.25	≥ 2.25	—

Dynamic characteristics

Transition frequency
($V_{CE} = 5 \text{ V}$; $I_C = 0.1 \text{ A}$)
($V_{CE} = 5 \text{ V}$; $I_C = 0.1 \text{ A}$; $f = 5 \text{ MHz}$)
 Collector-base capacitance
($V_{CB} = 10 \text{ V}$, $I_E = 0$, $f = 1 \text{ MHz}$)
 Switching times:
($I_C = 4.5 \text{ A}$, $I_B = 1.8 \text{ A}$, $L_B = 10 \mu\text{H}$)
($I_C = 4.5 \text{ A}$, $I_B = 1.8 \text{ A}$, $L_B = 10 \mu\text{H}$)

f_T	1	—	MHz
f_T	—	7	MHz
C_{CBO}	150	125	pF
t_f	0.7	0.7	μs
t_s	10	10	μs

Total perm. power dissipation versus temperature
 $P_{tot} = f(T_{case})$

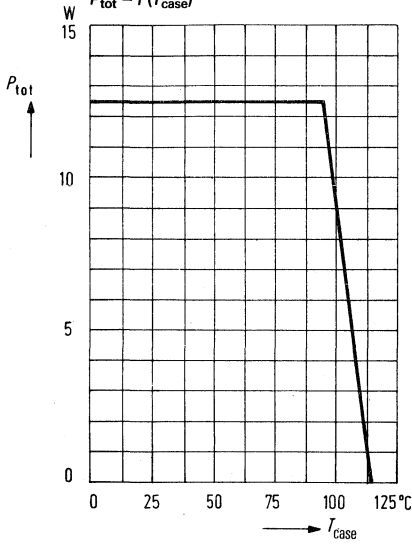

Permissible operating range
 $I_C = f(V_{CE}); T_{case} = 95^{\circ}C$

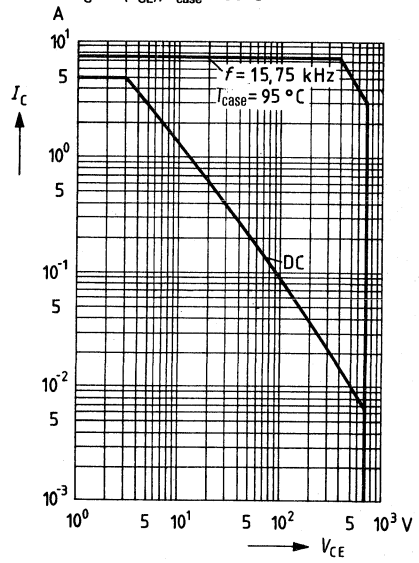

DC current gain $h_{FE} = f(I_C)$
 $T_{case} = \text{parameter}$

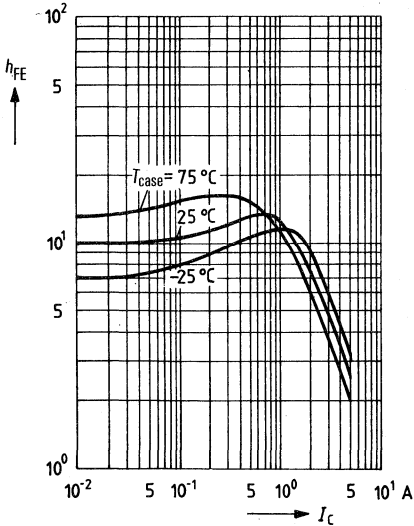

Output characteristics $I_C = f(V_{CE})$
 $I_B = \text{parameter}$

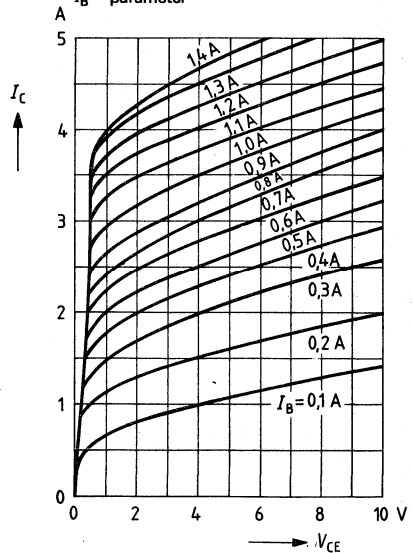

Collector-emitter saturation voltage

$V_{CEsat} = f(I_C)$
 $h_{FE} = 3; T_{case} = \text{parameter}$

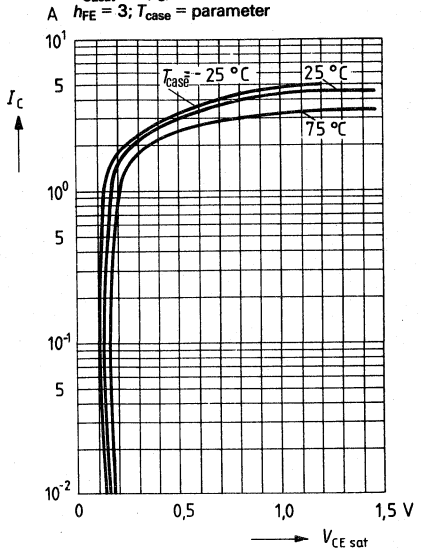

Base-emitter saturation voltage

$V_{BEsat} = f(I_C)$
 $h_{FE} = 3; T_{case} = \text{parameter}$

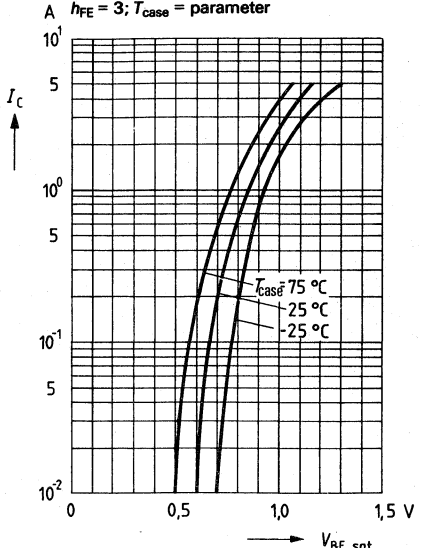

Collector-emitter saturation voltage

$V_{CEsat} = f(I_B)$
 $T_{case} = 25^\circ\text{C}; I_C = \text{parameter}$

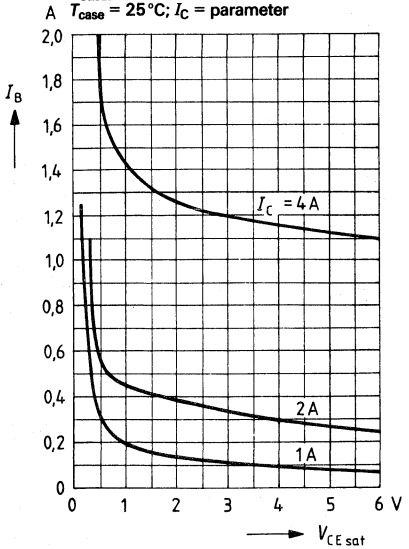

BU 326 A is a triple diffused silicon NPN power switching transistor in TO 3 case (3 B 2 DIN 41 872). It is outstanding for short switching times and high dielectric strength and is particularly suitable for use in power supply units of TV receivers. The collector is electrically connected to the case.

Type	Ordering code
BU 326 A	Q62702-U268

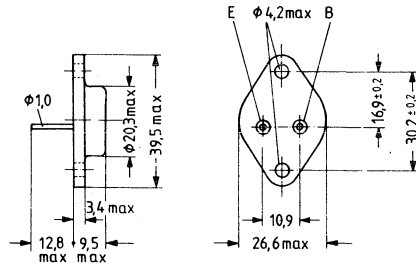

Approx. weight 18 g

Dimensions in mm

Maximum ratings

Collector-emitter voltage	V_{CES}	900	V
Collector-emitter voltage	V_{CEO}	400	V
Emitter-base voltage	V_{EBO}	7	V
Collector current	I_C	6	A
Collector peak current ($t_p \leq 1$ ms)	I_{CM}	8	A
Base current	I_B	2	A
Junction temperature	T_j	150	°C
Storage temperature range	T_{stg}	-65 to +150	°C
Total power dissipation ($T_{case} \leq 50$ °C; $V_{CE} = 18$ V)	P_{tot}	50	W

Thermal resistance

Junction to case	R_{thJC}	≤ 2	K/W
------------------	------------	----------	-----

Static characteristics ($T_{\text{case}} = 25\text{ }^{\circ}\text{C}$)

Collector-emitter breakdown voltage
 ($I_{\text{CEO}} = 100\text{ mA}$; pulse load $t_p = 200\text{ }\mu\text{s}$)

$V_{(\text{BR})\text{CEO}}$	> 400	V
-----------------------------	-------	---

Emitter-base breakdown voltage
 ($I_{\text{EBO}} = 5\text{ mA}$)

$V_{(\text{BR})\text{EBO}}$	> 7	V
-----------------------------	-----	---

Collector cutoff current
 ($V_{\text{CES}} = 900\text{ V}$)

I_{CES}	< 1	mA
------------------	-----	----

Base-emitter saturation voltage
 ($I_{\text{C}} = 4\text{ A}$; $V_{\text{CE}} = 5\text{ V}$)

V_{BEsat}	< 1.5	V
--------------------	-------	---

DC current gain

($I_{\text{C}} = 4\text{ A}$; $V_{\text{CE}} = 5\text{ V}$)

h_{FE}	3.5 to 12	–
-----------------	-----------	---

Dynamic characteristics ($T_{\text{case}} = 25\text{ }^{\circ}\text{C}$)

Transition frequency
 ($I_{\text{C}} = 0.2\text{ A}$; $V_{\text{CE}} = 10\text{ V}$)

f_{T}	6	MHz
----------------	---	-----

Switching time:

Fall time: ($I_{\text{C}} = 3\text{ A}$; $I_{\text{B1}} = I_{\text{B2}} = 1\text{ A}$; $V_{\text{CE}} = 250\text{ V}$)

t_{f}	< 0.5	μs
----------------	-------	---------------

Total perm. power dissipation versus temperature

$$k_T = \frac{P_{tot}(T_{case})}{P_{tot\ max}} = f(T_{case})$$

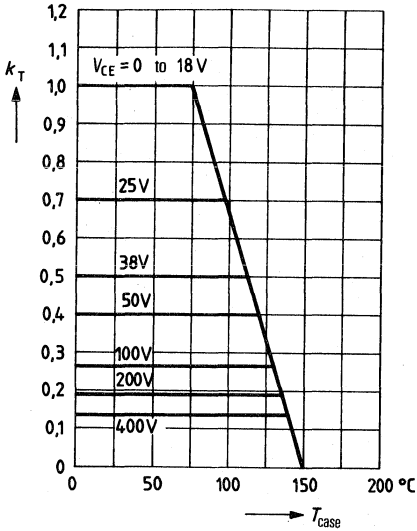

Total perm. power dissipation versus voltage

$$k_V = \frac{P_{tot}(V)}{P_{tot\ max}} = f(V_{CE})$$

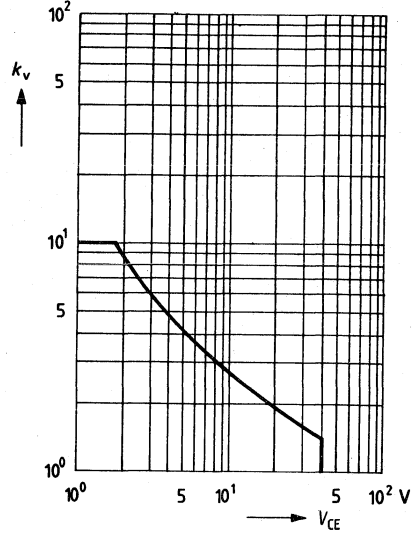

Permissible pulse load
 $m = f(t); v = \text{parameter}$

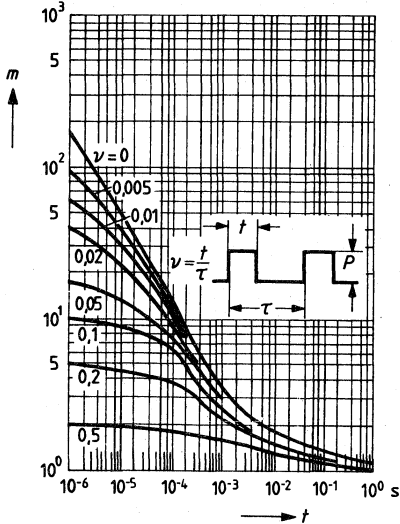

Permissible operating range

$$I_C = f(V_{CE}); v = 0; T_{case} = 75^\circ\text{C}$$

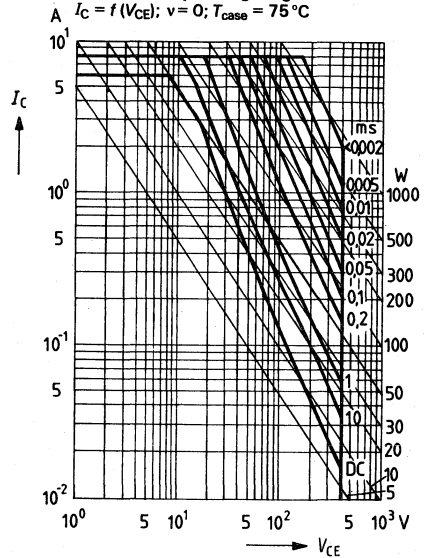

BU 426 and BU 426 A are triple diffused silicon power switching transistors in SOT 93 case (TOP 3). They are outstanding for short switching times and high dielectric strength and are particularly suitable for use in power supply units of TV receivers. The collector is electrically connected to the metallic mounting flange.

Type	Ordering code
BU 426	Q68000-A5164
BU 426 A	Q68000-A5165

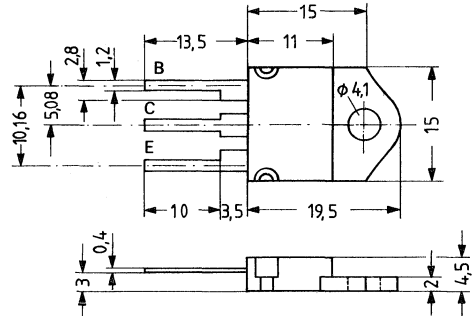

Approx. weight 20 g

Dimensions in mm

Maximum ratings

	BU 426	BU 426 A	
Collector-emitter peak voltage	800	900	V
Collector-emitter voltage	375	400	V
Emitter-base voltage	7	7	V
Collector current	6	6	A
Collector peak current ($t_p \leq 2$ ms)	8	8	A
Base current	2	2	A
Base peak current	3	3	A
Negative base current ($t < 20$ ms)	0.1	0.1	A
Negative base peak current at turning off	3	3	A
Emitter current	6	6	A
Emitter-peak current	8	8	A
Junction temperature	150	150	°C
Storage temperature range	-65 to +150		°C
Total power dissipation ($T_{case} \leq 73$ °C)	70	70	W

Thermal resistance

Junction to case	R_{thJC}	≤ 1.1	≤ 1.1	K/W
------------------	------------	------------	------------	-----

Static characteristics ($T_j = 25\text{ °C}$)

Collector cutoff current

($V_{BE} = 0, V_{CE} = 800\text{ V}$)

($V_{BE} = 0, V_{CE} = 800\text{ V}, T_j = 125\text{ °C}$)

Emitter cutoff current

($I_C = 0, V_{EB} = 7\text{ V}$)

Collector-emitter breakdown voltage

($I_B = 0, I_C = 100\text{ mA}, L = 25\text{ mH}$)

Collector-emitter saturation voltage

($I_C = 2.5\text{ A}, I_B = 0.5\text{ A}$)

($I_C = 4.0\text{ A}, I_B = 1.25\text{ A}$)

Base-emitter saturation voltage

($I_C = 2.5\text{ A}, I_B = 0.5\text{ A}$)

($I_C = 4.0\text{ A}, I_B = 1.25\text{ A}$)

DC current gain

($V_{CE} = 5\text{ V}, I_C = 0.6\text{ A}$)

	BU 426	BU 426 A	
I_{CES}	≤ 1	≤ 1	mA
I_{CES}	≤ 2	≤ 2	mA
I_{EBO}	≤ 10	≤ 10	mA
$V_{(BR)CEO}$	≥ 375	≥ 400	V
V_{CEsat}	≤ 1.5	≤ 1.5	V
V_{CEsat}	≤ 3	≤ 3	V
V_{BEsat}	≤ 1.4	≤ 1.4	V
V_{BEsat}	≤ 1.6	≤ 1.6	V
h_{FE}	30	30	–

Dynamic characteristics

Transition frequency

($V_{CE} = 10\text{ V}, I_C = 0.2\text{ A}, f = 1\text{ MHz}$)

f_T	6	6	MHz
-------	---	---	-----

BU 626 A is a triple diffused silicon NPN power switching transistor in TO 3 case (3 B 2 DIN 41 872). It is outstanding for short switching times and high dielectric strength and is particularly suitable for use in power supply units of TV receivers. The collector is electrically connected to the case.

Type	Ordering code
BU 626 A	Q68000-A4984

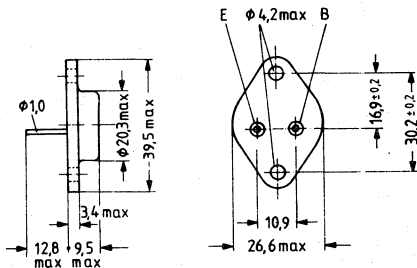

Approx. weight 18 g

Dimensions in mm

Maximum ratings

- Collector-base voltage
- Collector-emitter voltage
- Emitter-base voltage
- Collector current
- Collector-peak current
- Junction temperature
- Storage temperature range
- Total power dissipation
($T_{\text{case}} \leq 25^\circ\text{C}$; $V_{\text{CE}} = 20 \text{ V}$)

V_{CBS}	1000	V
V_{CEO}	400	V
V_{EBO}	7	V
I_{C}	10	A
I_{CM}	15	A
T_{j}	175	$^\circ\text{C}$
T_{stg}	-65 to +175	$^\circ\text{C}$
P_{tot}	100	W

Thermal resistance

- Junction to case

R_{thJC}	$\leq 1,5$	K/W
-------------------	------------	-----

Static characteristics ($T_{\text{case}} = 25^\circ\text{C}$)

Collector-emitter breakdown voltage ($I_{\text{CEO}} = 50 \text{ mA}$; pulse load = $200 \mu\text{s}$)	$V_{(\text{BR})\text{CEO}}$	> 400	V
Emitter-base-breakdown voltage ($I_{\text{EBO}} = 10 \text{ mA}$)	$V_{(\text{BR})\text{EBO}}$	> 7	V
Collector cutoff current ($V_{\text{CE}} = 1000 \text{ V}$)	$-I_{\text{CES}}$	< 1	mA
Base-emitter saturation voltage ($I_{\text{C}} = 8 \text{ A}$; $I_{\text{B}} = 2.5 \text{ A}$)	V_{BEsat}	< 2.2	V
Collector-emitter saturation voltage ($I_{\text{C}} = 8 \text{ A}$; $I_{\text{B}} = 2.5 \text{ A}$)	V_{CESat}	< 3.3	V
DC current gain ($I_{\text{C}} = 10 \text{ A}$; $V_{\text{CE}} = 1.5 \text{ V}$)	h_{FE}	> 10	—
($I_{\text{C}} = 2.5 \text{ A}$; $V_{\text{CE}} = 10 \text{ V}$)	h_{FE}	> 15	—

Dynamic characteristics ($T_{\text{case}} = 25^\circ\text{C}$)

Transition frequency ($I_{\text{C}} = 0.1 \text{ A}$; $V_{\text{CE}} = 10 \text{ V}$)	f_{T}	6	MHz
Switching time: Fall time ($I_{\text{C}} = 8 \text{ A}$; $I_{\text{B1}} = -I_{\text{B2}} = 2.5 \text{ A}$)	t_{f}	< 1	μs

Total perm. power dissipation versus temperature

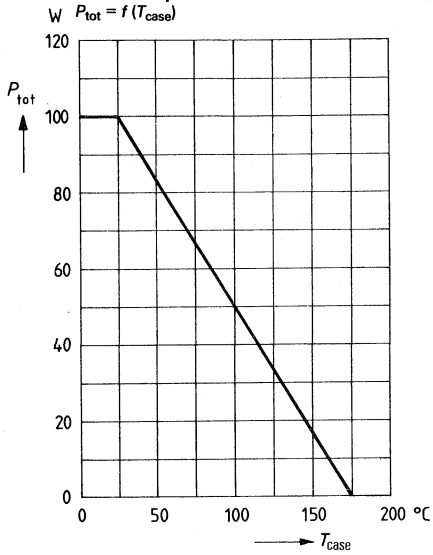

Permissible operating range

$I_C = f(V_{CE}); T_{case} = 25^\circ\text{C};$
for individual pulse ($v = 0$)

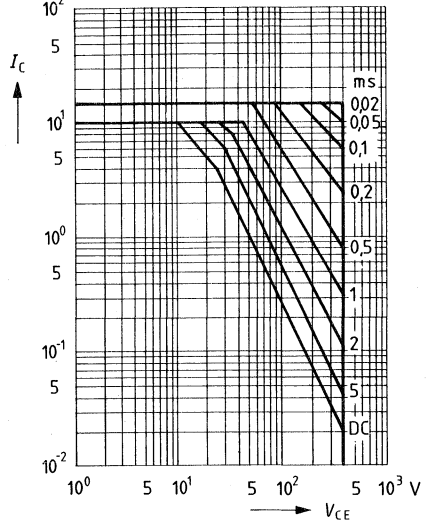

DC current gain $h_{FE} = f(I_C)$

$V_{CE} = 5\text{ V}; T_{case} = 25^\circ\text{C}$

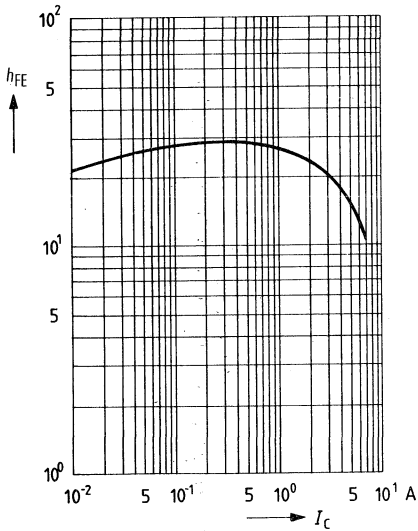

BUW 71, BUW 72, and BUW 73 are triple diffused silicon NPN power switching transistors in TO 3 case (3 A 2 DIN 41872). They are outstanding for short switching times and high dielectric strength and are particularly suitable for use in clocked voltage converters. The collector is electrically connected to the case.

Type	Ordering code
BUW 70	Q62702-U295
BUW 71	Q62702-U296
BUW 72	Q62702-U297
Mica washer	Q62901-B11-A
Insulating nipple	Q62901-B50

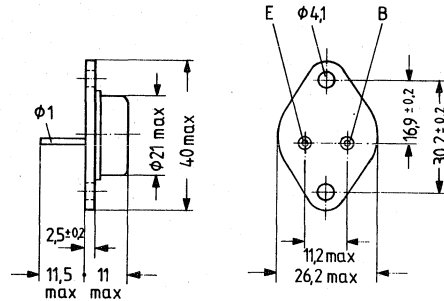
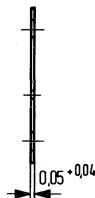
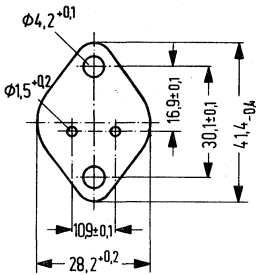

Approx. weight 18 g
Mica washer

Additional thermal resistance
dry: $R_{th} = 1.25 \text{ K/W}$
greased: $R_{th} = 0.35 \text{ K/W}$

Dimensions in mm

Maximum ratings

	BUW 70	BUW 71	BUW 72		
Collector-base voltage	V_{CB0}	150	450	450	V
Collector-emitter voltage	V_{CE0}	100	400	400	V
Emitter base voltage	V_{EB0}	7	7	7	V
Collector current	I_C	10	5	10	A
Base current	I_B	3	1.5	3	A
Junction temperature	T_j	150	150	150	°C
Storage temperature range	T_{stg}		-65 to +150		°C
Total power dissipation ($T_{case} \leq 25 \text{ °C}$)	P_{tot}	80	100	100	W

Thermal resistance

Junction to case	R_{thJC}	≤ 1.5	≤ 1.25	≤ 1.25	K/W
------------------	------------	------------	-------------	-------------	-----

Static characteristics ($T_{\text{case}} = 25\text{ }^{\circ}\text{C}$)		BUW 70	BUW 71	BUW 72	
Collector-emitter breakdown voltage ($I_{\text{CEO}} = 10\text{ mA}$)	$V_{(\text{BR})\text{CEO}}$	100	400	400	V
Collector cutoff current ($V_{\text{CBO}} = 450\text{ V}$)	I_{CBO}	–	0.1	0.1	mA
($V_{\text{CBO}} = 150\text{ V}$)	I_{CBO}	0.1	–	–	mA
Emitter cutoff current ($V_{\text{BEO}} = 7\text{ V}$)	I_{EBO}	0.1	0.1	0.1	mA
Collector-emitter saturation voltage ($I_{\text{C}} = 4\text{ A}, I_{\text{B}} = 0.8\text{ A}$)	V_{CEsat}	0.8	–	0.8	V
($I_{\text{C}} = 2\text{ A}, I_{\text{B}} = 0.4\text{ A}$)	V_{CEsat}	–	0.8	–	V
Base-emitter saturation voltage ($I_{\text{C}} = 4\text{ A}, I_{\text{B}} = 0.8\text{ A}$)	V_{BEsat}	1.5	–	1.5	V
($I_{\text{C}} = 2\text{ A}, I_{\text{B}} = 0.4\text{ A}$)	V_{BEsat}	–	1.5	–	V
DC current gain ($I_{\text{C}} = 4\text{ A}; V_{\text{CE}} = 5\text{ V}$)	h_{FE}	> 40	–	> 15	–
($I_{\text{C}} = 2\text{ A}, V_{\text{CE}} = 5\text{ V}$)	h_{FE}	–	> 15	–	–

Dynamic characteristics ($T_{\text{case}} = 25\text{ }^{\circ}\text{C}$)

Switching times:

$(I_{\text{C}} = 5\text{ A}, I_{\text{B1}} = -I_{\text{B2}} = 0.5\text{ A}, R_{\text{L}} = 10\text{ }\Omega)$	t_{f}	1	–	1.2	μs
	t_{on}	1	–	2	μs
	t_{s}	3	–	4	μs
$(I_{\text{C}} = 3\text{ A}, I_{\text{B1}} = -I_{\text{B2}} = 0.3\text{ A}, R_{\text{L}} = 20\text{ }\Omega)$	t_{f}	–	1.3	–	μs
	t_{on}	–	1.5	–	μs
	t_{s}	–	4	–	μs

Not for new design

BUX 28 is a triple diffused monolithic NPN darlington power transistor in TO 3 case (3 A 2 DIN 41 872). The collector is electrically connected to the case. The resistor between base and emitter as well as the inverting diode are integrated.

BUX 28 is particularly suitable for use in firing circuits of cars and for general purpose switching applications at high voltages.

Type	Ordering code
BUX 28	Q62702-U258
Mica washer	Q62901-B11-A
Insulating nipple	Q62901-B50

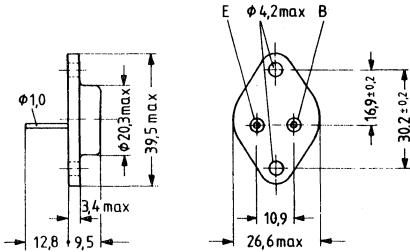
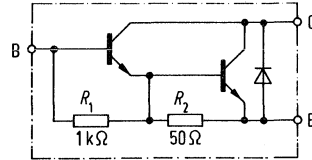

Approx. weight 18 g
Dimensions in mm

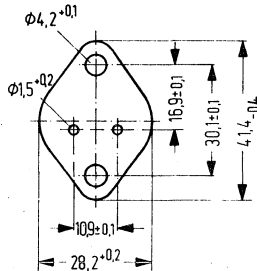

Mica washer dry: $R_{th} = 1.25 \text{ K/W}$
greased: $R_{th} = 0.35 \text{ K/W}$

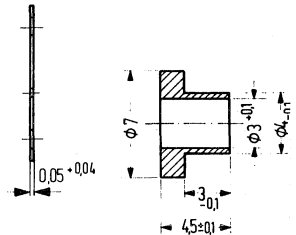

Insulating nipple

Maximum ratings

Collector-emitter voltage	V_{CEO}	350	V
Collector-emitter voltage	V_{CER}	350	V
Collector current	I_C	8	A
Collector peak current ($t_p < 1 \text{ ms}$)	I_{CM}	12	A
Current of the inverse diode	$-I_C$	8	A
Base current	I_B	1.5	A
Junction temperature	T_J	175	°C
Total power dissipation ($T_{case} \leq 55^\circ\text{C}$)	P_{tot}	80	W

Thermal resistance

Junction to case	R_{thJC}	< 1.2	K/W
------------------	------------	-------	-----

Static characteristics ($T_{case} = 25^\circ C$)

- Collector-emitter breakdown voltage
($I_C = 100\text{ mA}; L = 25\text{ mH}$)
- Collector cutoff current
- Collector cutoff current
($V_{CE} = 350\text{ V}$)
- ($V_{CE} = 350\text{ V}, T_{case} = 125^\circ C; t_p < 200\text{ }\mu s$)
- DC current gain
($I_C = 7\text{ A}; V_{CE} = 1.5\text{ V}$)
- Collector-emitter saturation voltage
($I_C = 10\text{ A}; I_B = 0.25\text{ A}$)
- Base-emitter saturation voltage
($I_C = 10\text{ A}; I_B = 0.25\text{ A}$)
- Forward voltage of the inverse diode
($-I_C = 7\text{ A}; I_B = 0$)

$V_{(BR)CEO}$	> 350	V^*
I_{CEO}	< 1	mA
I_{CEO}	< 1	mA
I_{CES}	< 10	mA
h_{FE}	> 10	-
V_{CEsat}	< 2	V^*
V_{BEsat}	< 2.4	V^*
$-V_{CE}$	1.5	V

* AQL = 0.65%

Total perm. power dissipation versus temperature
 $P_{tot} = f(T_{case}); V_{CE} = \text{parameter}$

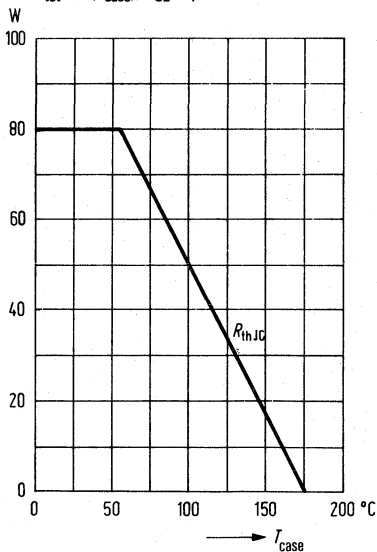

Permissible operating range
 $I_C = f(V_{CE}); T_{case} = 55^\circ C; v = 0$

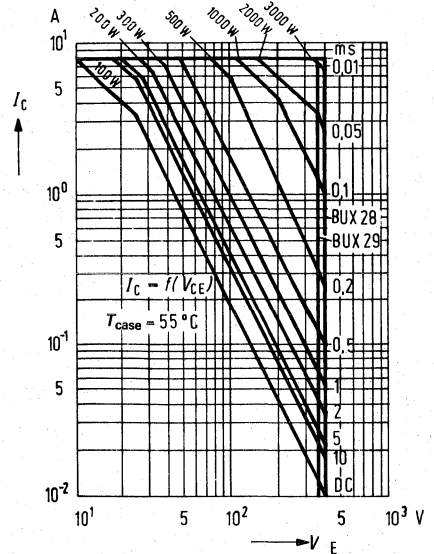

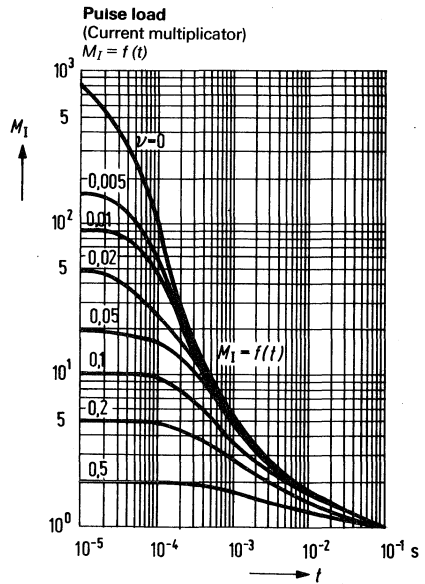
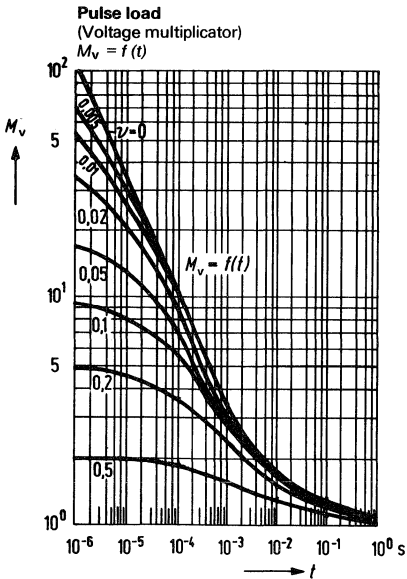
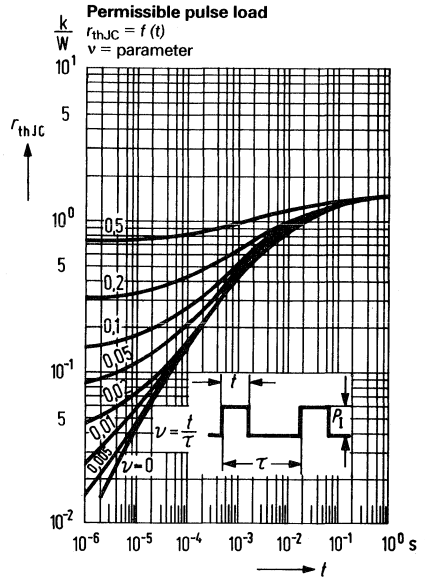

BUX 80 and BUX 81 are triple diffused NPN silicon power transistors in a case similar to TO 3 (3 A 2 DIN 41 872). The collector is electrically connected to the case. The transistors are particularly suitable for use as high-speed power switch at high voltages. BUX 80 is intended as replacement for BUW 77 (also BUW 76).

Type	Ordering code
BUX 80	Q68000-A4634
BUX 81	Q68000-A4675
Mica washer	Q62901-B11-A
Insulating nipple	Q62901-B50

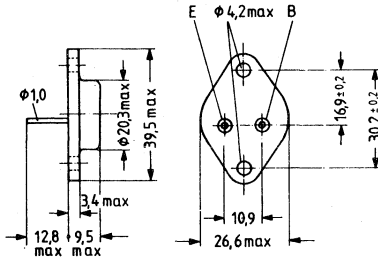
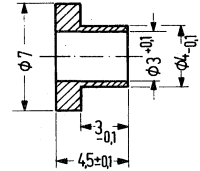

Approx. weight 18 g

Dimensions in mm

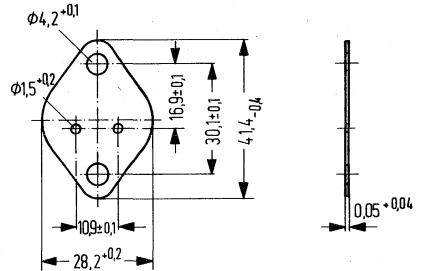

Maximum ratings

Collector-emitter voltage	V_{CES}	800	1000	V
Collector-emitter voltage	V_{CEO}	400	450	V
Collector-emitter voltage ($R_{BE} = 50 \Omega$)	V_{CER}	500	500	V
Collector current	I_C	10	10	A
Collector peak current ($t < 2$ ms)	I_{CM}	15	15	A
Base current	I_B	4	4	A
Base peak current ($t < 2$ ms)	I_{BM}	6	6	A
Negative base peak current at turning off	$-I_{BM}$	6	6	A
Storage temperature range	T_{stg}	-65 to +150		°C
Junction temperature	T_j	150	150	°C
Total power dissipation ($T_{case} \leq 40$ °C)	P_{tot}	100	100	W

	BUX 80	BUX 81	
V_{CES}	800	1000	V
V_{CEO}	400	450	V
V_{CER}	500	500	V
I_C	10	10	A
I_{CM}	15	15	A
I_B	4	4	A
I_{BM}	6	6	A
$-I_{BM}$	6	6	A
T_{stg}	-65 to +150		°C
T_j	150	150	°C
P_{tot}	100	100	W

Thermal resistance

Junction to case	R_{thJC}	≤ 1.1	≤ 1.1	K/W
------------------	------------	------------	------------	-----

Static characteristics ($T_{amb} = 25\text{ °C}$)

Collector-emitter breakdown voltage

($I_C = 100\text{ mA}$; $I_B = 0$; $L = 25\text{ mH}$)

($I_C = 100\text{ mA}$; $R_{BE} = 50\text{ }\Omega$; $L = 15\text{ mH}$)

Collector cutoff current

($V_{CES} = 800\text{ V}$)

($V_{CES} = 800\text{ V}$; $T_j = 125\text{ °C}$)

($V_{CES} = 1000\text{ V}$)

($V_{CES} = 1000\text{ V}$; $T_j = 125\text{ °C}$)

Emitter cutoff current ($V_{EBO} = 10\text{ V}$)

DC current gain ($I_C = 1.2\text{ A}$; $V_{CE} = 5\text{ V}$)

Collector-emitter saturation voltage

($I_C = 8\text{ A}$; $I_B = 2.5\text{ A}$)

($I_C = 5\text{ A}$; $I_B = 1\text{ A}$)

Base-emitter saturation voltage

($I_C = 8\text{ A}$; $I_B = 2.5\text{ A}$)

($I_C = 5\text{ A}$; $I_B = 1\text{ A}$)

	BUX 80	BUX 81	
$V_{(BR)CEO}$	> 400	> 450	V
$V_{(BR)CER}$	> 500	> 500	V
I_{CES}	< 1	–	mA
I_{CES}	< 3	–	mA
I_{CES}	–	< 1	mA
I_{CES}	–	< 3	mA
I_{EBO}	< 10	< 10	mA
h_{FE}	30	30	–
V_{CESat}	< 3	< 3	V
V_{CESat}	< 1.5	< 1.5	V
V_{BEsat}	< 1.8	< 1.8	V
V_{BEsat}	< 1.4	< 1.4	V

Dynamic characteristics ($T_{amb} = 25\text{ °C}$)

Transition frequency

($I_C = 0.2\text{ A}$; $V_{CE} = 10\text{ V}$; $f = 1\text{ MHz}$)

Switching times:

($V_{CC} = 250\text{ V}$; $I_C = 5\text{ A}$; $I_B = 1\text{ A}$; $-I_B = 2\text{ A}$)

Turn-on time

Storage time

Fall time¹⁾

f_T	6	6	MHz
t_{on}	0.35 (<0.5)	0.35 (<0.5)	μs
t_s	2.5 (<3.5)	2.5 (<3.5)	μs
t_f	0.3	0.3	μs

1) at $T_{case} = 95\text{ °C}$ is $t_f < 0.8\text{ }\mu\text{s}$

Total perm. power dissipation versus temperature
 $P_{tot} = f(T_{case})$

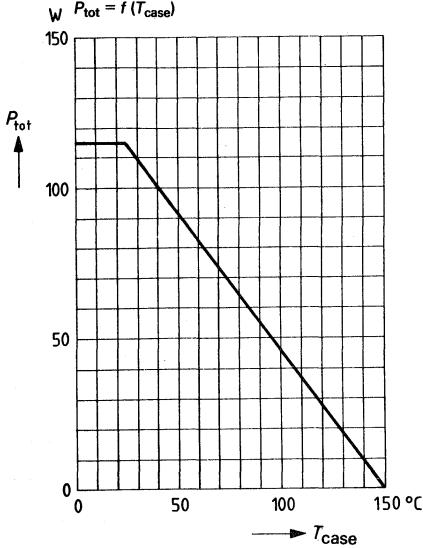

Permissible pulse load
 $Z_{thJC} = f(t); v = \text{parameter}$

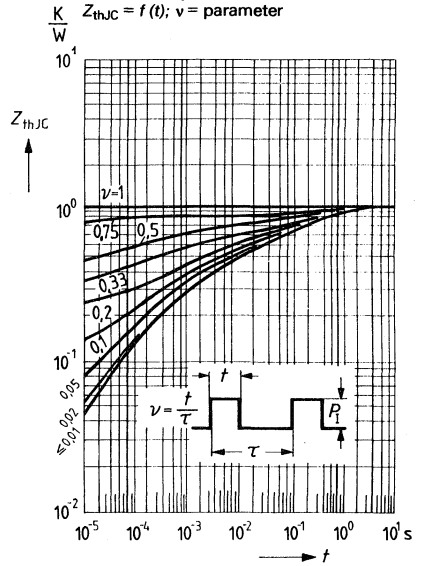

Permissible operating range
 $I_C = f(V_{CE}); T_{case} \leq 25^\circ\text{C}$

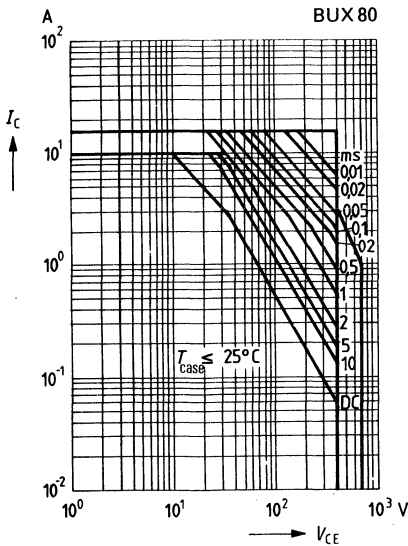

Permissible operating range
 $I_C = f(V_{CE}); T_{amb} \leq 40^\circ\text{C}$

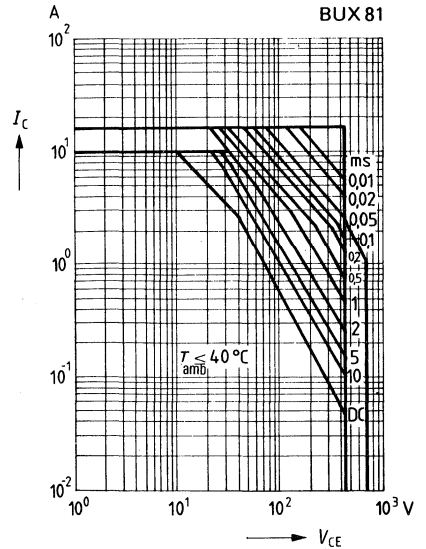

DC current gain $h_{FE} = f(I_C)$
 $V_{CE} = 5 \text{ V}; T_{\text{case}} = 25^\circ\text{C}$

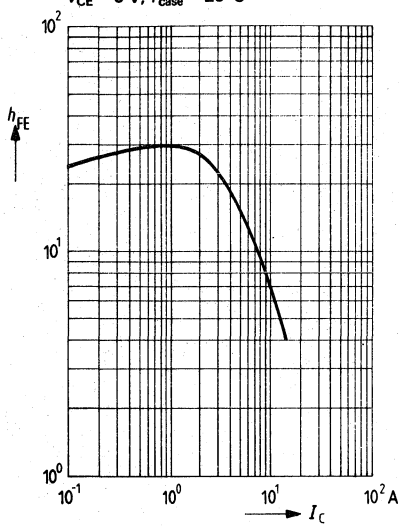

Oscillator – voltage curve

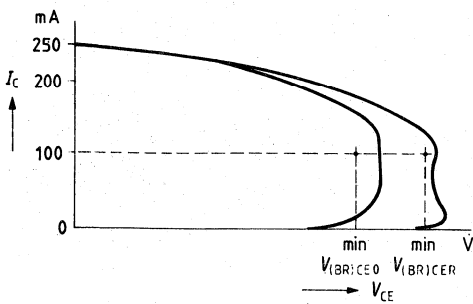

Timing diagram

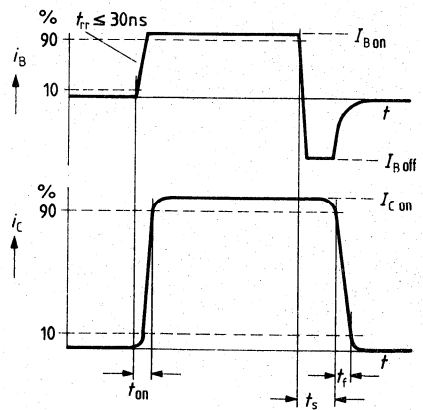

Test circuits for breakdown voltages

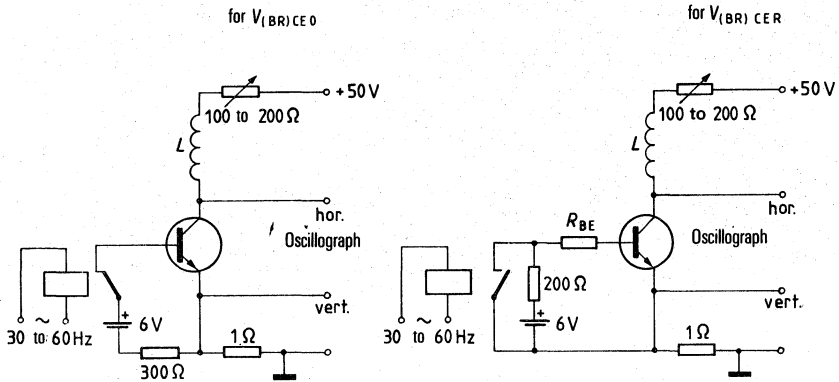

Test circuit for switching times

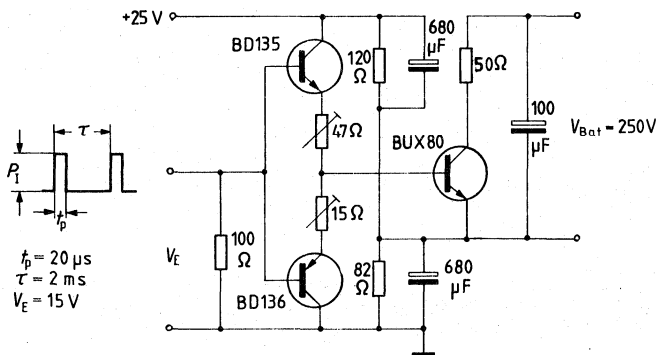

BUX 82 and BUX 83 are triple diffused NPN silicon power transistors in a case similar to TO 3 (3 A 2 DIN 41872). The collector is electrically connected to the case. The transistors are particularly designed for use as high-speed power switch at high voltages. BUX 82 is suitable as replacement for BUX 26, BUX 27 (also BUY 79).

Type	Ordering code
BUX 82	Q68000-A4676
BUX 83	Q68000-A4677
Mica washer	Q62901-B11-A
Insulating nipple	Q62901-B20

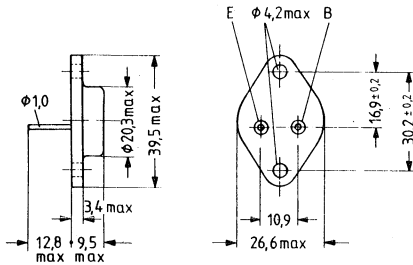
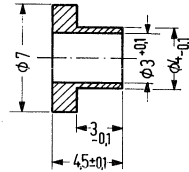

Approx. weight 18 g

Dimensions in mm

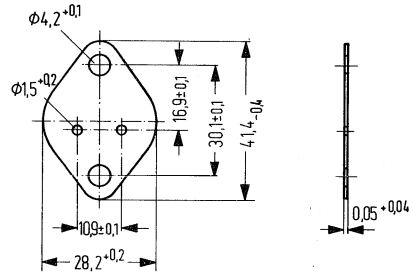

Maximum ratings

- Collector-emitter voltage
- Collector-emitter voltage
- Collector-emitter voltage ($R_{BE} = 50 \Omega$)
- Collector current
- Collector peak current ($t < 2 \text{ ms}$)
- Base current
- Base peak current ($t < 2 \text{ ms}$)
- Negative base peak current
- Storage temperature range
- Junction temperature
- Total power dissipation ($T_{case} \leq 25 \text{ }^\circ\text{C}$)

	BUX 82	BUX 83	
V_{CES}	800	1000	V
V_{CEO}	400	450	V
V_{CER}	500	500	V
I_C	6	6	A
I_{CM}	8	8	A
I_B	2	2	A
I_{BM}	3	3	A
$-I_{BM}$	3	3	A
T_{stg}	-65 to +150		$^\circ\text{C}$
T_j	150	150	$^\circ\text{C}$
P_{tot}	75	75	W

Thermal resistance

Junction to case	R_{thJC}	≤ 1.65	≤ 1.65	K/W
------------------	------------	-------------	-------------	-----

Static characteristics ($T_{amb} = 25\text{ °C}$)

Collector-emitter breakdown voltage

($I_C = 100\text{ mA}$; $I_B = 0$; $L = 25\text{ mH}$)

($I_C = 100\text{ mA}$; $R_{BE} = 100\text{ }\Omega$; $L = 15\text{ mH}$)

Collector cutoff current

($V_{CES} = 800\text{ V}$)

($V_{CES} = 800\text{ V}$; $T_j = 125\text{ °C}$)

($V_{CES} = 1000\text{ V}$)

($V_{CES} = 1000\text{ V}$; $T_j = 125\text{ °C}$)

Emitter cutoff current ($V_{EBO} = 10\text{ V}$)

DC current gain ($I_C = 1.2\text{ A}$; $V_{CE} = 5\text{ V}$)

Collector-emitter saturation voltage

($I_C = 4\text{ A}$; $I_B = 1.25\text{ A}$)

($I_C = 2.5\text{ A}$; $I_B = 0.5\text{ A}$)

Base-emitter saturation voltage

($I_C = 4\text{ A}$; $I_B = 1.25\text{ A}$)

($I_C = 2.5\text{ A}$; $I_B = 0.5\text{ A}$)

	BUX 82	BUX 83	
$V_{(BR)CEO}$	> 400	> 450	V
$V_{(BR)CER}$	> 500	> 500	V
I_{CES}	< 1	–	mA
I_{CES}	< 2	–	mA
I_{CES}	–	< 1	mA
I_{CES}	–	< 2	mA
I_{EBO}	< 10	< 10	mA
h_{FE}	30	30	–
V_{CESat}	< 3	< 1.6	V
V_{CESat}	< 1.5	< 1.4	V
V_{BESat}	< 1.6	< 1.6	V
V_{BESat}	< 1.4	< 1.4	V

Dynamic characteristics ($T_{amb} = 25\text{ °C}$)

Transition frequency

($I_C = 0.2\text{ A}$; $V_{CE} = 10\text{ V}$; $f = 1\text{ MHz}$)

Switching times:

($V_{CC} = 250\text{ V}$; $I_C = 2.5\text{ A}$; $I_{B1} = 0.5\text{ A}$,

$-I_{B2} = 1\text{ A}$)

Turn-on time

Storage time

Fall time¹⁾

f_T	6	6	MHz
t_{on}	0.3 (< 0.5)	0.3 (< 0.5)	μs
t_s	2 (< 3.5)	2 (< 3.5)	μs
t_f	0.3	0.3	μs

1) at $T_{case} = 95\text{ °C}$ is $t_f \leq 1\text{ }\mu\text{s}$

Total perm. power dissipation versus temperature
 $P_{tot} = f(T_{case})$

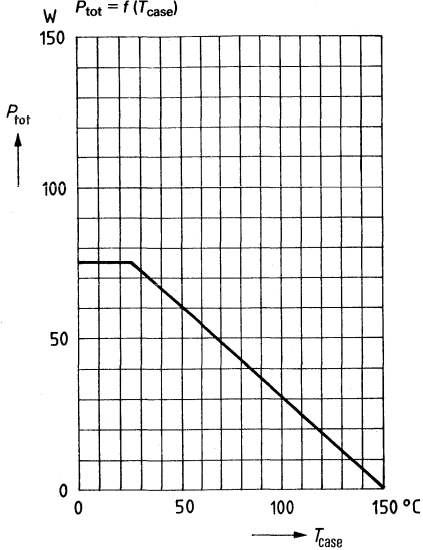

Permissible pulse load
 $Z_{thJC} = f(t); v = \text{parameter}$

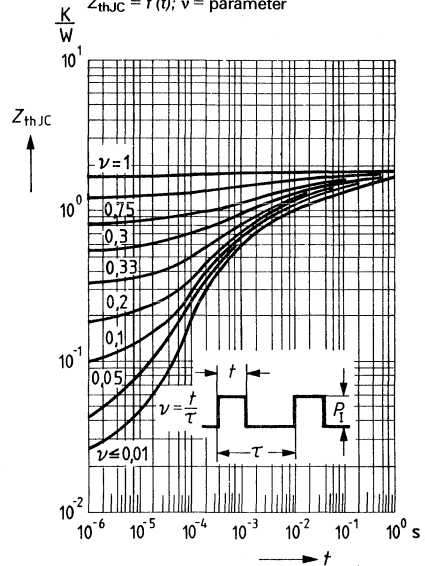

Permissible operating range
 $I_C = f(V_{CE}); T_{case} \leq 25^{\circ}C$

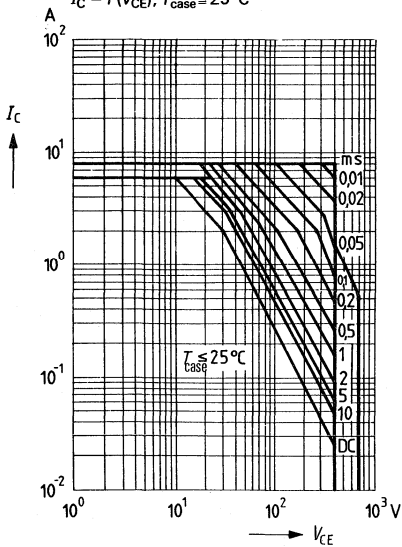

Permissible operating range
 $I_C = f(V_{CE}); T_{amb} \leq 50^{\circ}C$

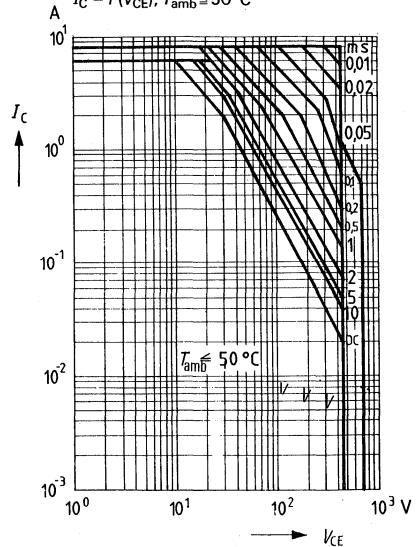

DC current gain $h_{FE} = f(I_C)$
 $V_{CE} = 5 \text{ V}; T_{case} = 25^\circ\text{C}$

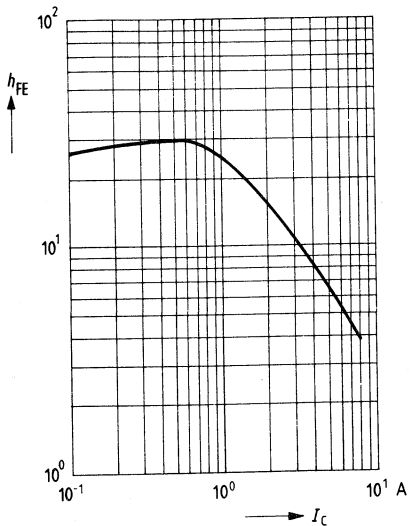

Oscillator – voltage curve

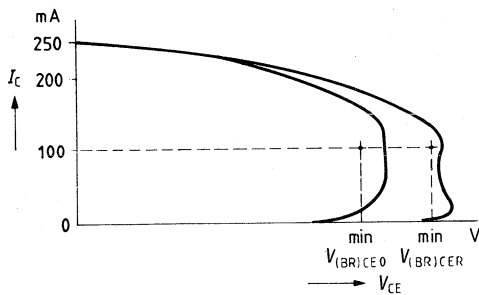

Timing diagram

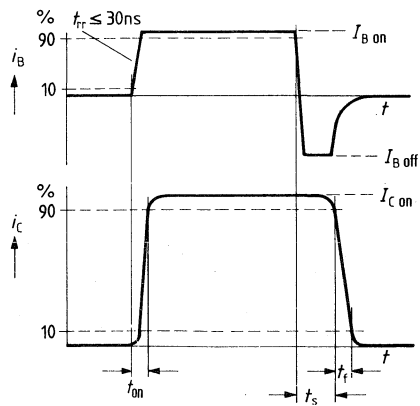

Test circuits for breakdown voltages

for $V_{(BR)CE0}$

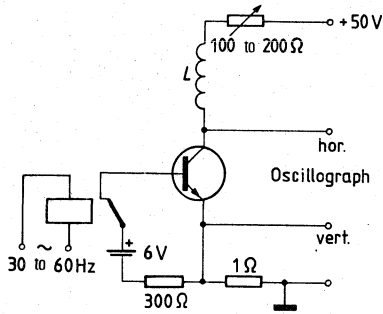

for $V_{(BR)CER}$

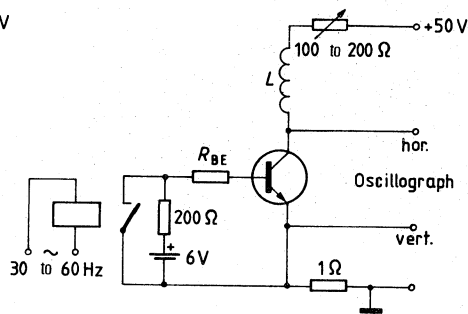

Test circuit for switching times

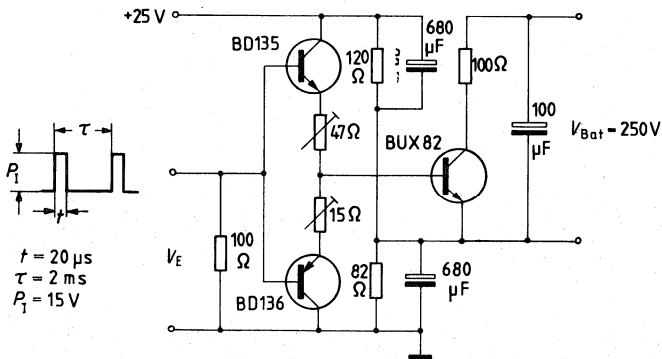

BUX 84 and BUX 85 are triple diffused NPN silicon power transistors in TO 220 cases. They are outstanding for their short switching times and high dielectric strength, and are particularly suitable for switching power supplies in TV sets. The collector is electrically connected to the metallic mounting area.

Type	Ordering code
BUX 84	Q68000-A3869
BUX 85	Q68000-A5166

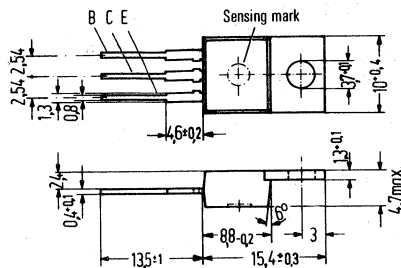

Approx. weight 18 g Dimensions in mm

Maximum ratings

Collector-emitter voltage	V_{CES}	800	1000	V
Collector-emitter voltage	V_{CEO}	400	450	V
Emitter-base voltage	V_{EBO}	10	10	V
Collector current	I_C	2	2	A
Collector-peak current ($t_p \leq 1$ ms)	I_{CM}	3	3	A
Base current	I_B	0.75	0.75	A
Base peak current	I_{BM}	1	1	A
Negative base peak current at turning off	$-I_{BM}$	1	1	A
Storage temperature range	T_{stg}	-65 to +150		°C
Junction temperature	T_j	150	150	°C
Total power dissipation ($T_{case} \leq 50$ °C)	P_{tot}	40	40	W

Thermal resistance

Junction to mounting flange	R_{thJC}	≤ 2.5	≤ 2.5	K/W
-----------------------------	------------	------------	------------	-----

Static characteristics ($T_{amb} = 25\text{ °C}$)

		BUX 84	BUX 85	
Collector-emitter breakdown voltage ($I_C = 100\text{ mA}$; $I_B = 0$; $L = 25\text{ mH}$)	$V_{(BR)CEO}$	≥ 400	≥ 450	V
Collector cutoff current ($V_{CES} = 800\text{ V}$)	I_{CES}	≤ 1	–	mA
($V_{CES} = 800\text{ V}$; $T_j = 125\text{ °C}$)	I_{CES}	≤ 1.5	–	mA
($V_{CES} = 1000\text{ V}$)	I_{CES}	–	≤ 0.2	mA
($V_{CES} = 1000\text{ V}$; $T_j = 125\text{ °C}$)	I_{CES}	–	≤ 1.5	mA
Emitter cutoff current ($V_{EBO} = 5\text{ V}$)	I_{EBO}	≤ 1	≤ 1	mA
Collector-emitter saturation voltage ($I_C = 0.3\text{ A}$; $I_B = 0.03\text{ A}$)	V_{CEsat}	≤ 1.5	≤ 1.5	V
($I_C = 1\text{ A}$; $I_B = 0.2\text{ A}$)	V_{CEsat}	≤ 3	≤ 3	V
Base-emitter saturation voltage ($I_C = 1\text{ A}$; $I_B = 0.2\text{ A}$)	V_{BEsat}	≤ 1.1	≤ 1.1	V

Dynamic characteristics ($T_{amb} = 25\text{ °C}$)

Transition frequency ($V_{CE} = 10\text{ V}$; $I_C = 0.2\text{ A}$; $f = 1\text{ MHz}$)	f_T	20	20	MHz
Switching times: ($V_{CC} = 250\text{ V}$; $I_C = 1\text{ A}$; $I_B = 0.2\text{ A}$; $-I_B = 0.4\text{ A}$)				
Turn-on time	t_{on}	0.2 (<0.5)	0.2 (<0.5)	μs
Storage time	t_s	0.2 (<3.5)	2 (<3.5)	μs
Fall time ¹⁾	t_f	0.4	0.4	μs

1) at $T_{case} = 95\text{ °C}$ is $t_f \leq 1\text{ }\mu\text{s}$

Total perm. power dissipation versus temperature

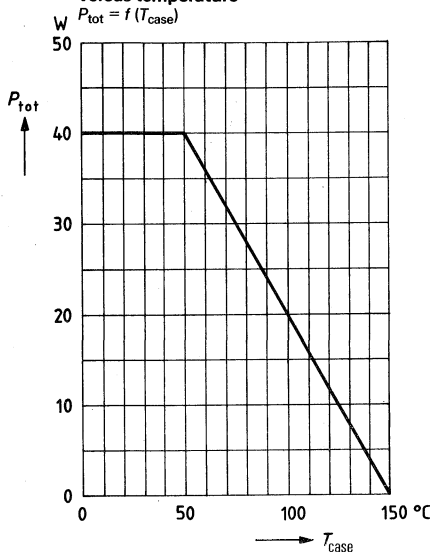

Permissible pulse load

$Z_{thJC} = f(t); v = \text{parameter}$

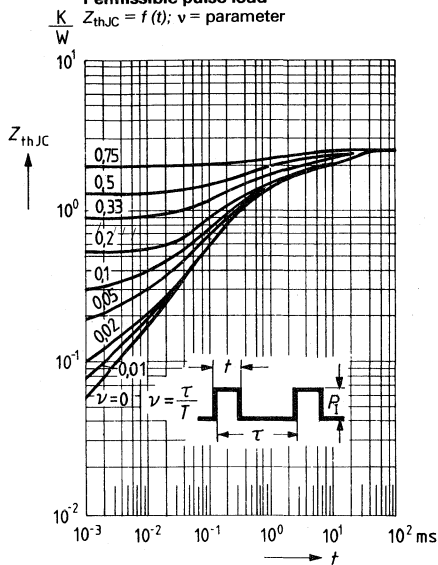

Permissible operating range

$I_C = f(V_{CE}); T_{case} \leq 50^\circ\text{C}$

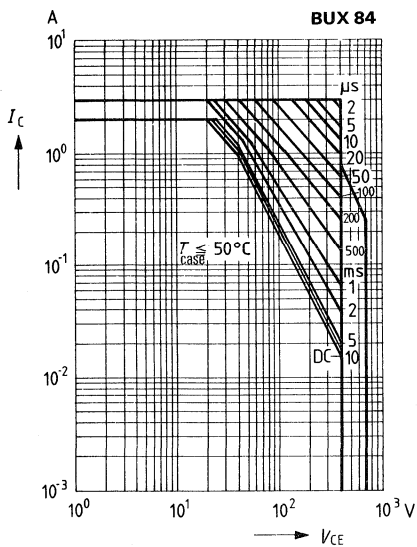

Permissible operating range

$I_C = f(V_{CE}); T_{case} \leq 50^\circ\text{C}$

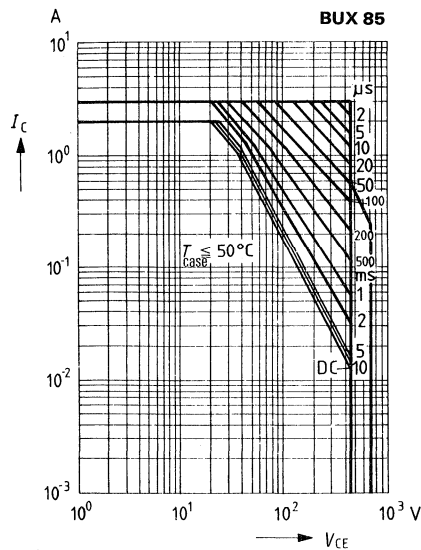

DC current gain $h_{FE} = f(I_C)$
 $V_{CE} = 5 \text{ V}; T_{\text{case}} = 25^\circ\text{C}$

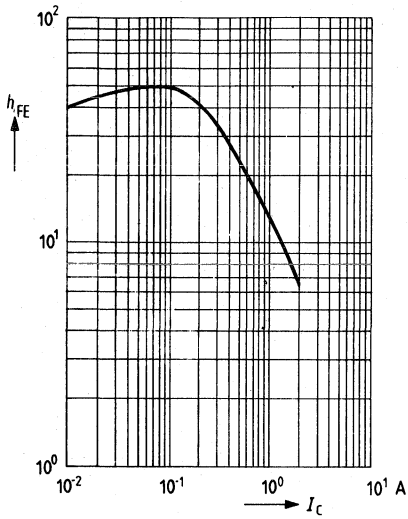

Test circuit for breakdown voltage $V_{(BR)CEO}$

for: $V_{(BR)CEO}$

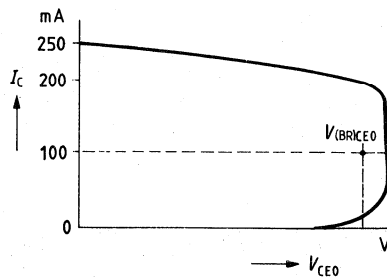
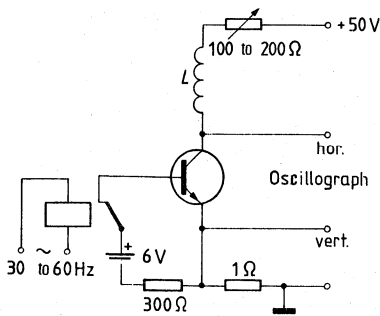

Test circuit for switching times

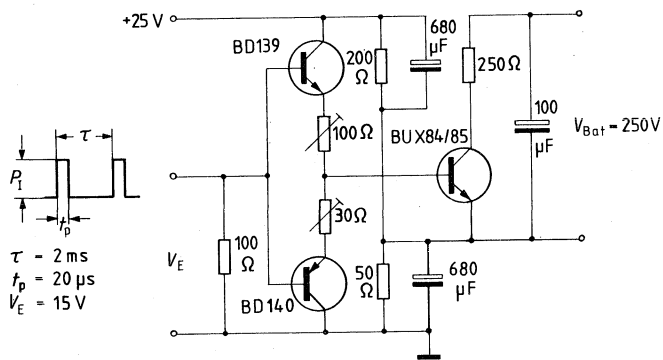
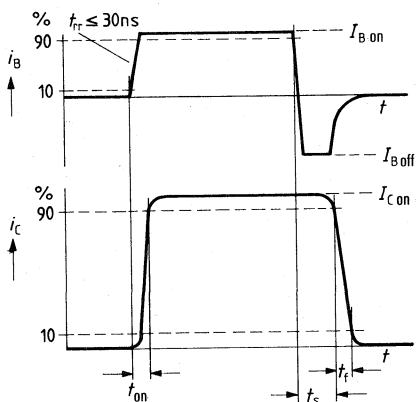

BUX 86 and BUX 87 are NPN silicon epibase power switching transistors in TO 126 plastic package (12 A 3 DIN 41869). They are outstanding for their short switching times and high dielectric strength and are particularly suitable for use in switching power supplies of TV sets. The collector is electrically connected to the metallic mounting area.

Type	Ordering code
BUX 86	Q68000-A3870
BUX 87	Q68000-A5167

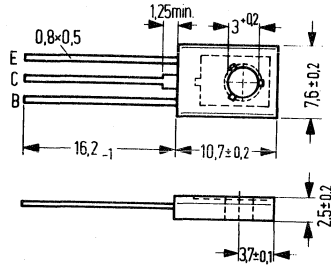

Approx. weight 0.5 g Dimensions in mm

Maximum ratings

	BUX 86	BUX 87	
Collector-emitter voltage	V_{CES} 800	1000	V
Collector-emitter voltage	V_{CEO} 400	450	V
Collector current	I_C 0.5	0.5	A
Collector peak current ($t_p \leq 2$ ms)	I_{CM} 1.0	1.0	A
Base current	I_B 0.2	0.2	A
Base peak current	I_{BM} 0.3	0.3	A
Negative base peak current at turning off	$-I_{BM}$ 0.3	0.3	A
Storage temperature range	T_{stg} -65 to +150		°C
Junction temperature	T_j 150	150	°C
Total power dissipation ($T_{case} \leq 60^\circ\text{C}$)	P_{tot} 20	20	W

Thermal resistance

Junction to mounting area	R_{thJC}	≤ 4.5	≤ 4.5	K/W
---------------------------	------------	------------	------------	-----

Static characteristics ($T_{amb} = 25^{\circ}\text{C}$)

Collector-emitter breakdown voltage

($I_C = 100\text{ mA}$; $I_B = 0$; $L = 25\text{ mH}$)

Collector cutoff current

($V_{CES} = 800\text{ V}$)

($V_{CES} = 800\text{ V}$; $T_j = 150^{\circ}\text{C}$)

($V_{CES} = 1000\text{ V}$)

($V_{CES} = 1000\text{ V}$; $T_j = 150^{\circ}\text{C}$)

Emitter cutoff current ($V_{EBO} = 5\text{ V}$)

DC current gain ($V_{CE} = 5\text{ V}$; $I_C = 50\text{ mA}$)

Collector-emitter saturation voltage

($I_C = 100\text{ mA}$; $I_B = 10\text{ mA}$)

($I_C = 200\text{ mA}$; $I_B = 20\text{ mA}$)

Base-emitter saturation voltage

($I_C = 200\text{ mA}$; $I_B = 20\text{ mA}$)

	BUX 86	BUX 87	
$V_{(BR)CEO}$	≥ 400	≥ 450	V
I_{CES}	< 0.1	–	mA
I_{CES}	< 1	–	mA
I_{CES}	–	< 0.1	mA
I_{CES}	–	< 1	mA
I_{EBO}	< 1	< 1	mA
h_{FE}	50	50	–
V_{CEsat}	< 1.5	< 1.5	V
V_{CEsat}	< 3	< 3	V
V_{BEsat}	< 1	< 1	V

Dynamic characteristics ($T_{amb} = 25^{\circ}\text{C}$)

Transition frequency

($V_{CE} = 10\text{ V}$; $I_C = 50\text{ mA}$; $f = 1\text{ MHz}$)

Switching times

($V_{CC} = 250\text{ V}$; $I_C = 200\text{ mA}$; $I_B = 20\text{ mA}$;

$-I_B = 40\text{ mA}$)

Turn-on time

Storage time

Fall time¹⁾

f_T	20	20	MHz
t_{on}	0.25 (< 0.5)	0.25 (< 0.5)	μs
t_s	2 (< 3.5)	2 (< 3.5)	μs
t_f	0.4	0.4	μs

1) at $T_{case} = 95^{\circ}\text{C}$ is $t_f \leq 1.4\ \mu\text{s}$

Total perm. power dissipation versus temperature
 $P_{tot} = f(T_{case})$

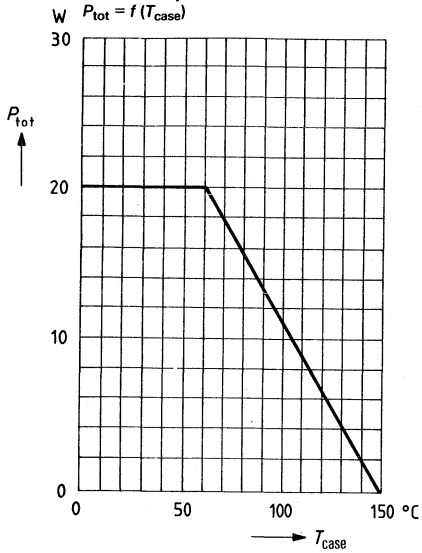

Permissible pulse load
 $Z_{thJC} = f(t); v = \text{parameter}$

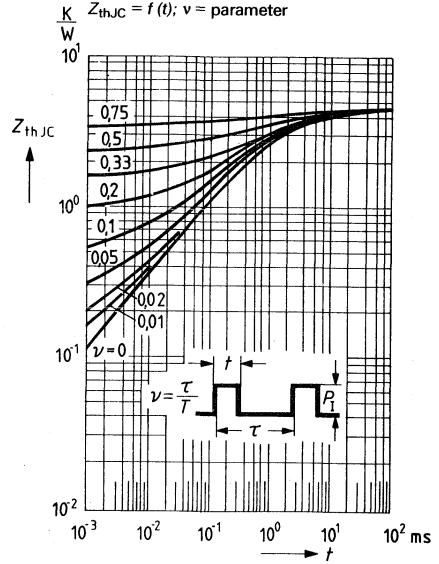

Permissible operating range
 $I_C = f(V_{CE}); T_{case} \leq 60^\circ\text{C}$

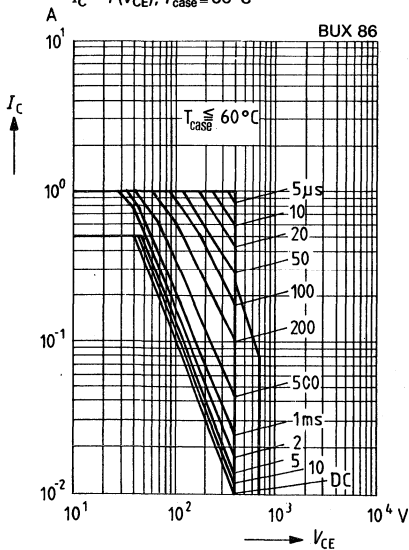

Permissible operating range
 $I_C = f(V_{CE}); T_{case} \leq 60^\circ\text{C}$

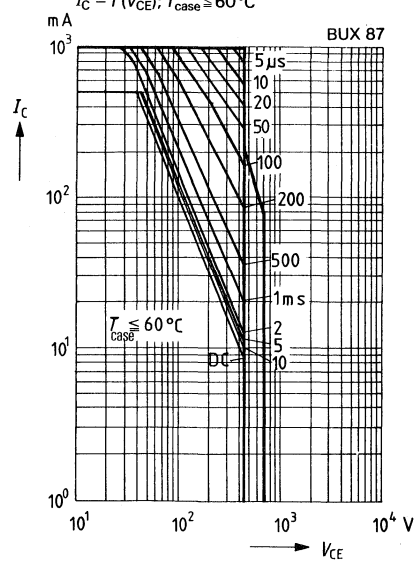

DC current gain $h_{FE} = f(I_C)$
 $V_{CE} = 5 \text{ V}; T_{amb} = 25^\circ\text{C}$

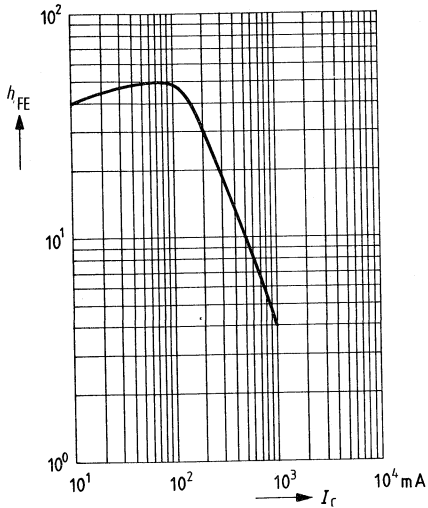

Test circuit for breakdown voltage $V_{(BR)CEO}$

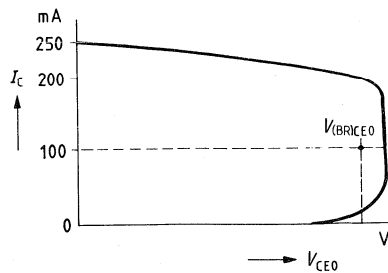
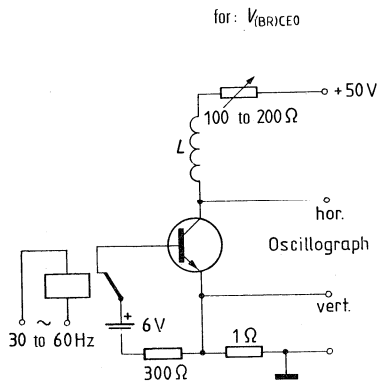

Test circuit for switching times

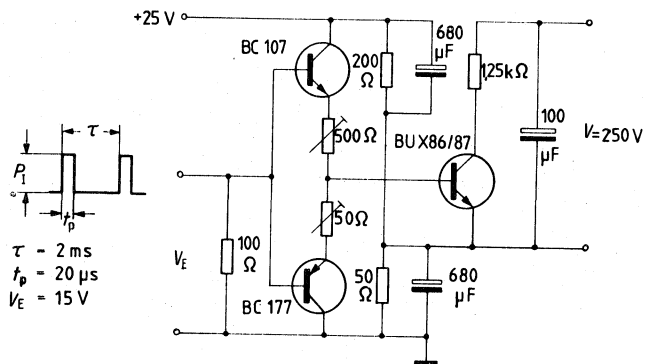
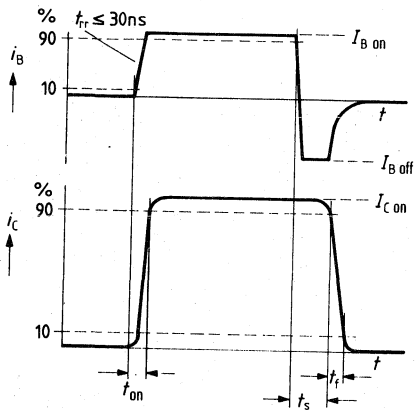

This component, a transistor with integrated base emitter resistance and a Z diode, in TO 236 case (24 A 3 DIN 41869) is designed for use as control unit in various professional and industrial electronic circuits. Due to the compact design of microelectronic circuits, it is particularly suitable for hybrid circuits in thick and thin film technology.

The type is marked with the code letters "TZ".

Type	Mark	Ordering code
BZW 20	TZ	Q62702-Z1387

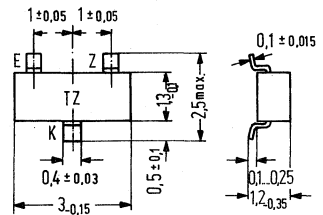
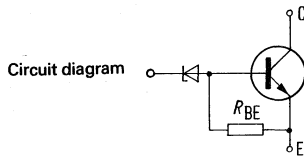

Approx. weight 0.02 g
Dimensions in mm

Maximum ratings

- Collector-emitter voltage
- Base-emitter voltage
- Collector current
- Base current
- Storage temperature range
- Junction temperature
- Total power dissipation ($T_{amb} \leq 45^\circ\text{C}$)

V_{CEO}	20	V
V_{ZE}	8.4 to 9.5	V
I_C	100	mA
I_z	10	mA
T_{stg}	-55 to +125	$^\circ\text{C}$
T_j	115	$^\circ\text{C}$
P_{tot}	150	mW

Thermal resistance

- Junction to ambient air if mounted on:
- Glass substrate (7 x 7 x 1 mm)
- Glass fiber substrate (30 x 12 x 1.5 mm)
- Ceramic substrate (30 x 12 x 1 mm)

R_{thJA}	< 700	K/W
R_{thJA}	< 450	K/W
R_{thJA}	< 450	K/W

Static characteristics ($T_{amb} = 25\text{ }^{\circ}\text{C}$)

Collector cutoff current

($V_{CE} = 20\text{ V}$)

($V_{CE} = 20\text{ V}; T_{amb} = 125\text{ }^{\circ}\text{C}$)

Collector-emitter breakdown voltage

($I_C = 100\text{ }\mu\text{A}$)

DC current gain

($I_C = 50\text{ mA}; V_{CE} = 1.5\text{ V}$)

Collector-emitter saturation voltage

($I_C = 18\text{ mA}; I_Z = 2\text{ mA}$)

Differential current gain

($I_C = 16\text{ mA}; V_{CE} = 1.5\text{ V}$)

Differential transconductance

($I_C = 18\text{ mA}; V_{CE} = 1.5\text{ V}$)

I_{CE0}	< 100	nA
I_{CEO}	< 30	μA
$V_{(BR)CEO}$	> 20	V
h_{FE}	> 15	-
V_{CEsat}	< 0.4	V
$h_{fe} = \frac{\Delta I_C}{\Delta I_Z}$	250	-
$S = \frac{\Delta I_C}{\Delta V_{ZE}}$	700	mS

Total perm. power dissipation versus temperature

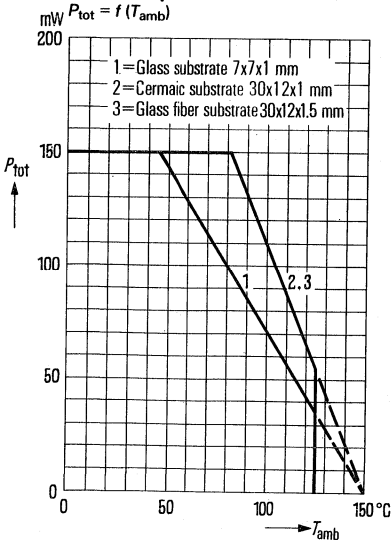

Thermal resistance versus substrate area

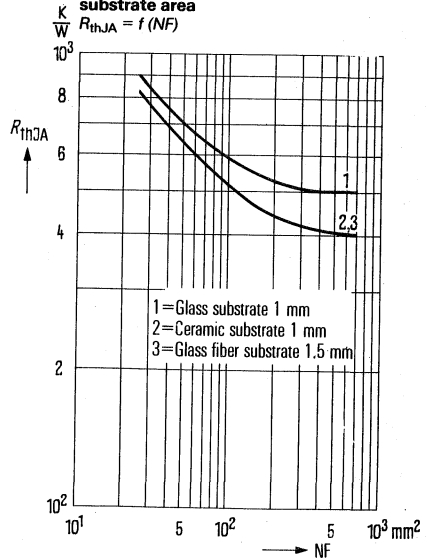

Permissible pulse load for ceramic substrate 30 x 12 x 1,5 mm

K
W
 $r_{thJC} = f(t); v = \text{parameter}$

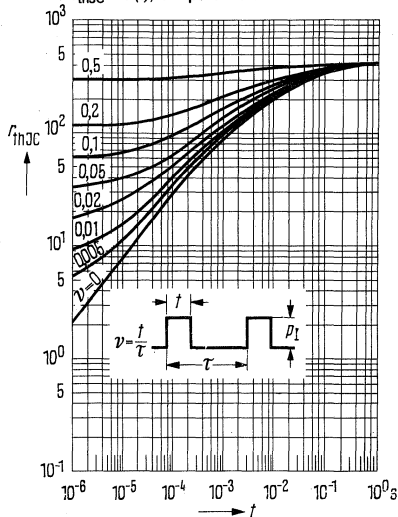

Permissible pulse load for glass substrate 7 x 7 x 1 mm

K
W
 $r_{thJC} = f(t); v = \text{parameter}$

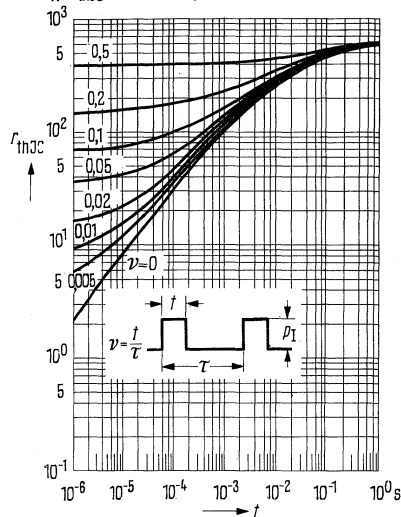

Differential current gain

$$h_{fe} = \frac{\Delta I_c}{\Delta I_z} = f(I_c)$$

$V_{CE} = 1,5 \text{ V}; f = 1 \text{ kHz}$

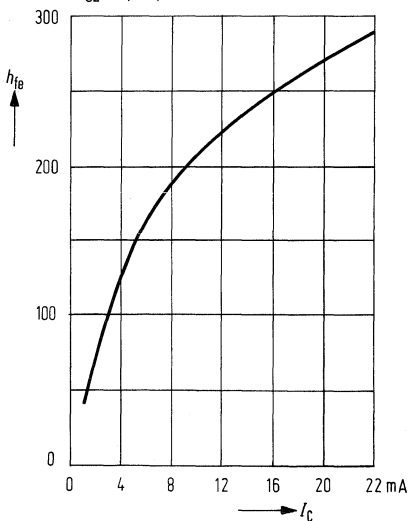

Differential transconductance

$$S = \frac{\Delta I_c}{\Delta V_{ZE}} = f(I_c)$$

$V_{CE} = 1,5 \text{ V}; f = 1 \text{ kHz}$

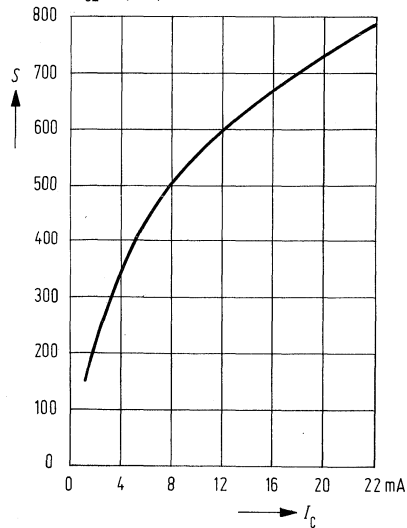

NPN Silicon Planar Transistors

2 N 2218
2 N 2219
2 N 2218 A
2 N 2219 A

2 N 2218, 2 N 2219, 2 N 2218 A, and 2 N 2219 A are epitaxial NPN silicon planar transistors in TO 39 case (5 C 3 DIN 41873). The collector is electrically connected to the case. The transistors are particularly suitable for use as high-speed switches of medium performance.

Type	Ordering code
2 N 2218	Q62702-F109
2 N 2219	Q62702-F133
2 N 2218 A	Q62702-S29
2 N 2219 A	Q62702-F59

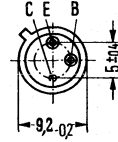
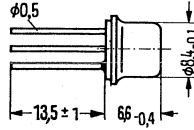

Approx. weight 1.5 g

Dimensions in mm

Maximum ratings

	2 N 2218 2 N 2219	2 N 2218 A 2 N 2219 A	
Collector-base voltage	V_{CBO} 60	75	V
Collector-emitter voltage	V_{CEO} 30	40	V
Emitter-base voltage	V_{EBO} 5	6	V
Collector current	I_C 0.8	0.8	A
Junction temperature	T_j 175	175	°C
Storage temperature range	T_{stg}	-65 to +200	°C
Total power dissipation ($T_{amb} \leq 25^\circ\text{C}$)	P_{tot} 0.8	0.8	W
Total power dissipation ($T_{case} \leq 25^\circ\text{C}$)	P_{tot} 3	3	W

Thermal resistance

Junction to ambient air	R_{thJA}	≤ 188	≤ 188	K/W
Junction to case	R_{thJC}	≤ 50	≤ 50	K/W

Static characteristics ($T_{amb} = 25^{\circ}\text{C}$)

Collector-emitter saturation voltage

($I_C = 150\text{ mA}$; $I_B = 15\text{ mA}$)

($I_C = 500\text{ mA}$; $I_B = 50\text{ mA}$)

Base emitter saturation voltage

($I_C = 150\text{ mA}$; $I_B = 15\text{ mA}$)

($I_C = 500\text{ mA}$; $I_B = 50\text{ mA}$)

Collector cutoff current

($V_{CBO} = 50\text{ V}$)

($V_{CBO} = 50\text{ V}$; $T_{amb} = 150^{\circ}\text{C}$)

Collector-emitter breakdown voltage

($I_C = 10\text{ mA}$; $I_B = 0$)

Collector-base breakdown voltage

($I_C = 10\text{ }\mu\text{A}$; $I_E = 0$)

Emitter-base breakdown voltage

($I_E = 10\text{ }\mu\text{A}$; $I_C = 0$)

DC current gain

($V_{CE} = 10\text{ V}$; $I_C = 0.1\text{ mA}$)

($V_{CE} = 10\text{ V}$; $I_C = 1\text{ mA}$)

($V_{CE} = 10\text{ V}$; $I_C = 10\text{ mA}$)

($V_{CE} = 10\text{ V}$; $I_C = 150\text{ mA}$)

($V_{CE} = 10\text{ V}$; $I_C = 500\text{ mA}$)

	2 N 2218	2 N 2219	
V_{CEsat}	≤ 0.4	≤ 0.4	V
V_{CEsat}	≤ 1.6	≤ 1.6	V
V_{BEsat}	0.6 to 2	0.6 to 2	V
V_{BEsat}	≤ 2.6	≤ 2.6	V
I_{CBO}	≤ 0.01	≤ 0.01	μA
I_{CBO}	≤ 10	≤ 10	μA
$V_{(BR)CEO}$	30	30	V
$V_{(BR)CBO}$	60	60	V
$V_{(BR)EBO}$	5	5	V
h_{FE}	> 20	> 35	-
h_{FE}	> 25	> 50	-
h_{FE}	> 35	> 75	-
h_{FE}	40 to 120	100 to 300	-
h_{FE}	> 20	> 30	-

Static characteristics ($T_{amb} = 25\text{ }^{\circ}\text{C}$)		2 N 2218 A	2 N 2219 A	
Collector-emitter saturation voltage				
($I_C = 150\text{ mA}$; $I_B = 15\text{ mA}$)	V_{CEsat}	≤ 0.3	≤ 0.3	V
($I_C = 500\text{ mA}$; $I_B = 50\text{ mA}$)	V_{CEsat}	≤ 1	≤ 1	V
Base-emitter saturation voltage				
($I_C = 150\text{ mA}$; $I_B = 15\text{ mA}$)	V_{BEsat}	0.6 to 1.2	0.6 to 1.2	V
($I_C = 500\text{ mA}$; $I_B = 50\text{ mA}$)	V_{BEsat}	≤ 2	≤ 2	V
Emitter cutoff current ($V_{EBO} = 3\text{ V}$)	I_{EBO}	≤ 10	≤ 10	nA
Collector cutoff current ($V_{CBO} = 60\text{ V}$)	I_{CBO}	≤ 0.01	≤ 0.01	μA
Collector cutoff current ($V_{CBO} = 60\text{ V}$; $T_{amb} = 150\text{ }^{\circ}\text{C}$)	I_{CBO}	≤ 10	≤ 10	μA
Collector-emitter breakdown voltage ($I_C = 10\text{ mA}$; $I_B = 0$)	$V_{(BR)CEO}$	> 40	> 40	V
Collector-base breakdown voltage ($I_C = 10\text{ }\mu\text{A}$; $I_E = 0$)	$V_{(BR)CBO}$	> 75	> 75	V
Emitter-base breakdown voltage ($I_E = 10\text{ }\mu\text{A}$; $I_C = 0$)	$V_{(BR)EBO}$	> 6	> 6	V
DC current gain				
($V_{CE} = 10\text{ V}$; $I_C = 0.1\text{ mA}$)	h_{FE}	> 20	> 35	—
($V_{CE} = 10\text{ V}$; $I_C = 1\text{ mA}$)	h_{FE}	> 25	> 50	—
($V_{CE} = 10\text{ V}$; $I_C = 10\text{ mA}$)	h_{FE}	> 35	> 75	—
($V_{CE} = 10\text{ V}$; $I_C = 10\text{ mA}$; $T_{amb} = -55\text{ }^{\circ}\text{C}$)	h_{FE}	> 15	> 35	—
($V_{CE} = 10\text{ V}$; $I_C = 150\text{ mA}$)	h_{FE}	40 to 120	100 to 300	—
($V_{CE} = 1\text{ V}$; $I_C = 150\text{ mA}$)	h_{FE}	> 20	> 50	—
($V_{CE} = 10\text{ V}$; $I_C = 500\text{ mA}$)	h_{FE}	> 20	> 40	—

2 N 2218
2 N 2219
2 N 2218 A
2 N 2219 A

Dynamic characteristics ($T_{amb} = 25\text{ }^{\circ}\text{C}$)		2 N 2218	2 N 2219	
Transition frequency ($V_{CE} = 20\text{ V}$; $I_C = 20\text{ mA}$; $f = 100\text{ MHz}$)	f_T	> 250	> 250	MHz
Collector-base capacitance ($V_{CBO} = 10\text{ V}$; $f = 100\text{ kHz}$)	C_{CBO}	≤ 8	≤ 8	pF
Emitter base capacitance ($V_{EBO} = 0.5\text{ V}$; $f = 100\text{ kHz}$)	C_{EBO}	< 30	< 30	pF

Dynamic characteristics ($T_{amb} = 25\text{ }^{\circ}\text{C}$)		2 N 2218 A	2 N 2219 A	
Transition frequency ($V_{CE} = 20\text{ V}$; $I_C = 20\text{ mA}$; $f = 100\text{ MHz}$)	f_T	> 250	> 300	MHz
Collector base capacitance ($V_{CBO} = 10\text{ V}$; $f = 100\text{ kHz}$)	C_{CBO}	< 8	< 8	pF
Emitter base capacitance ($V_{EBO} = 0.5\text{ V}$; $f = 100\text{ kHz}$)	C_{EBO}	< 25	< 25	pF
Feedback time constant ($V_{CB} = 20\text{ V}$; $I_C = 20\text{ mA}$; $f = 31.8\text{ MHz}$)	$r_{bb'}$; $C_{b'c}$	< 150	< 150	ps
Noise figure ($V_{CE} = 10\text{ V}$; $I_C = 100\text{ }\mu\text{A}$; $f = 1\text{ kHz}$; $R_g = 1\text{ k}\Omega$)	NF	–	< 4	dB

Switching times:

($I_C = 150\text{ mA}$; $I_{B1} = -I_{B2} = 15\text{ mA}$, $V_{CC} = 30\text{ V}$)

Delay time	t_d	≤ 10	≤ 10	ns
Rise time	t_r	≤ 25	≤ 25	ns
Storage time	t_s	≤ 225	≤ 225	ns
Fall time	t_f	≤ 60	≤ 60	ns

Four-pole characteristics

$(V_{CE} = 10\text{ V}$; $I_C = 1\text{ mA}$; $f = 1\text{ kHz})$	h_{11e}	1 to 3.5	2 to 8	k Ω
	h_{12e}	$< 5 \cdot 10^{-4}$	$< 8 \cdot 10^{-4}$	–
	h_{21e}	30 to 150	50 to 300	–
	h_{22e}	3 to 15	5 to 35	μS
$(V_{CE} = 10\text{ V}$; $I_C = 10\text{ mA}$; $f = 1\text{ kHz})$	h_{11e}	0.2 to 1	0.25 to 1.25	k Ω
	h_{12e}	$2.5 \cdot 10^{-4}$	$4 \cdot 10^{-4}$	–
	h_{21e}	50 to 300	75 to 375	–
	h_{22e}	10 to 100	25 to 200	μS

2 N 2218
2 N 2219
2 N 2218 A
2 N 2219 A

Total perm. power dissipation versus temperature

$P_{tot} = f(T)$

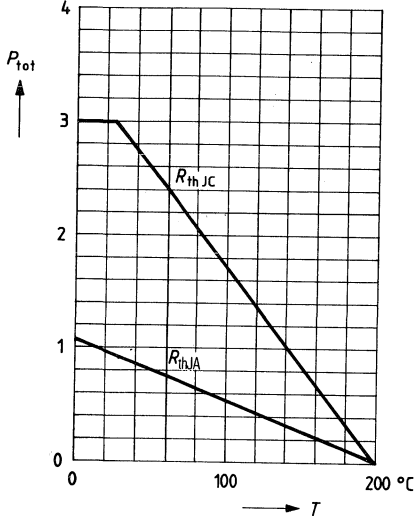

Permissible pulse load $r_{thJC} = f(t)$

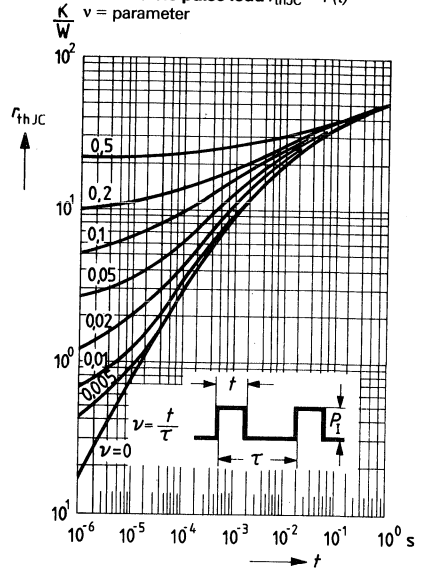

DC current gain $h_{FE} = f(I_C)$

$V_{CE} = 1V, V_{CE} = 10V; T_{amb} = 25^\circ C$

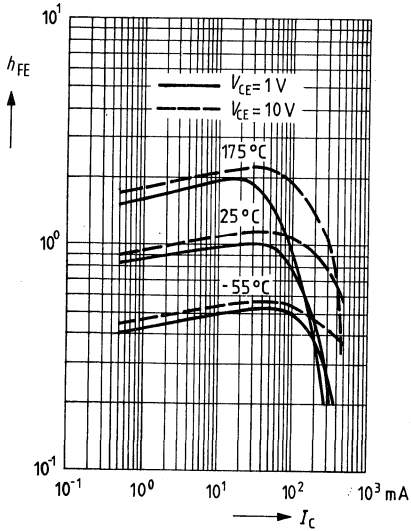

Saturation voltages

$V_{BEsat} = f(I_C), V_{CEsat} = f(I_C)$

$h_{FE} = 10; T_{amb} = 25^\circ C$

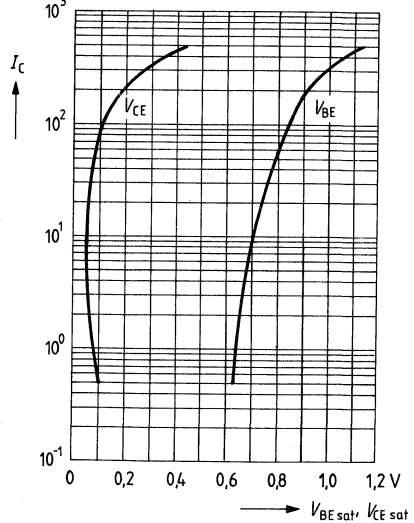

2 N 2218
2 N 2219
2 N 2218 A
2 N 2219 A

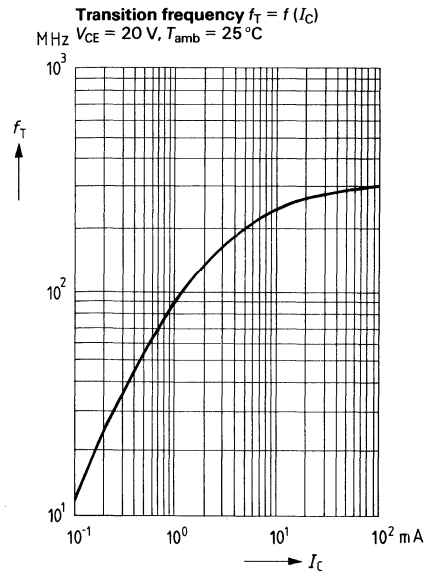
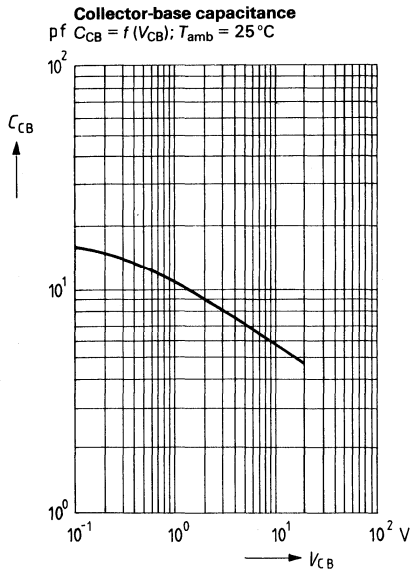
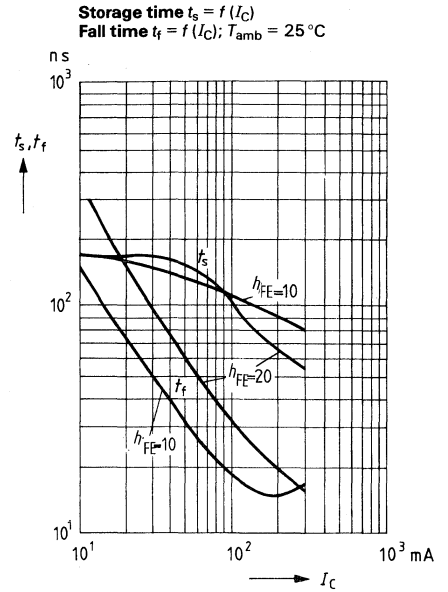
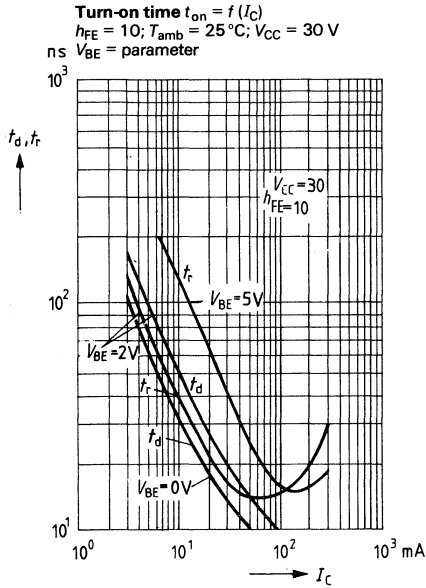

NPN Silicon Planar Transistors

2 N 2220
2 N 2221
2 N 2222

2 N 2220, 2 N 2221, and 2 N 2222 are epitaxial NPN silicon planar transistors in TO 18 case (18 A 3 DIN 41 876). The collector is electrically connected to the case. The transistors are particularly suitable for use as high-speed switches.

Type	Ordering code
2 N 2220	Q68000-A4573
2 N 2221	Q62702-F134
2 N 2222	Q62702-F135

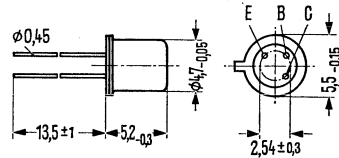

Approx. weight 0.33 g Dimensions in mm

Maximum ratings

	2 N 2220	2 N 2221	2 N 2222
Collector-emitter voltage	30		V
Collector-base voltage	60		V
Emitter-base voltage	5		V
Collector current	0.8		A
Junction temperature	175		°C
Storage temperature range	-65 to +200		°C
Total power dissipation ($T_{amb} = 25\text{ °C}$)	0.5		W
Total power dissipation ($T_{case} = 25\text{ °C}$)	1.8		W

Thermal resistance

Junction to ambient air	R_{thJA}	≤ 300	K/W
Junction to case	R_{thJC}	≤ 83	K/W

Static characteristics ($T_{amb} = 25\text{ }^{\circ}\text{C}$)		2 N 2220	2 N 2221	2 N 2222	
Collector-base breakdown voltage ($I_C = 10\text{ }\mu\text{A}$)	$V_{(BR)CBO}$	> 60	> 60	> 60	V
Collector-emitter breakdown voltage ($I_C = 10\text{ mA}$)	$V_{(BR)CEO}$	> 30	> 30	> 30	V
Emitter-base breakdown voltage ($I_E = 10\text{ }\mu\text{A}$)	$V_{(BR)EBO}$	> 5	> 5	> 5	V
Collector-emitter saturation voltage ($I_B = 15\text{ mA}$; $I_C = 150\text{ mA}$)	V_{CEsat}	< 0.4	< 0.4	< 0.4	V
($I_B = 50\text{ mA}$; $I_C = 500\text{ mA}$)	V_{CEsat}	-	< 1.6	< 1.6	V
Base-emitter saturation voltage ($I_C = 150\text{ mA}$; $I_B = 15\text{ mA}$)	V_{BEsat}	< 1.3	< 1.3	< 1.3	V
($I_C = 500\text{ mA}$; $I_B = 50\text{ mA}$)	V_{BEsat}	-	< 2.6	< 2.6	V
Emitter cutoff current ($V_{EB} = 3\text{ V}$)	I_{EBO}	< 10	< 10	< 10	nA
Collector cutoff current ($V_{CB} = 50\text{ V}$)	I_{CBO}	< 10	< 10	< 10	nA
($V_{CB} = 50\text{ V}$; $T_{amb} = 150\text{ }^{\circ}\text{C}$)	I_{CBO}	< 10	< 10	< 10	μA
DC current gain ($V_{CE} = 10\text{ V}$; $I_C = 0.1\text{ mA}$)	h_{FE}	-	> 20	> 35	-
($V_{CE} = 10\text{ V}$; $I_C = 1\text{ mA}$)	h_{FE}	> 12	> 25	> 50	-
($V_{CE} = 10\text{ V}$; $I_C = 10\text{ mA}$)	h_{FE}	> 17	> 35	> 75	-
($V_{CE} = 10\text{ V}$; $I_C = 150\text{ mA}$)	h_{FE}	20 to 60	40 to 120	100 to 300	-
($V_{CE} = 10\text{ V}$; $I_C = 500\text{ mA}$)	h_{FE}	-	> 20	> 30	-
($V_{CE} = 1\text{ V}$; $I_C = 150\text{ mA}$)	h_{FE}	> 10	> 20	> 50	-
Dynamic characteristics ($T_{amb} = 25\text{ }^{\circ}\text{C}$)					
Collector base capacitance ($V_{CB} = 10\text{ V}$; $f = 1\text{ MHz}$)	C_{CBO}	< 8	< 8	< 8	pF
Transition frequency ($V_{CE} = 20\text{ V}$; $I_C = 20\text{ mA}$; $f = 100\text{ MHz}$)	f_T	> 250	> 250	> 250	MHz
Switching times: ($V_{CC} = 20\text{ V}$; $I_C = 150\text{ mA}$; I_{B1} approx. I_{B2} approx. 150 mA)					
Delay time	t_d	5	5	5	ns
Rise time	t_r	15	15	15	ns
Storage time	t_s	190	190	190	ns
Fall time	t_f	23	23	23	ns

NPN Silicon Planar Transistors

2 N 2221 A
2 N 2222 A

2 N 2221 A, and 2 N 2222 A are epitaxial NPN silicon planar transistors in TO 18 case (18 A 3 DIN 41876). The collector is electrically connected to the case. The transistors are particularly suitable for use as high-speed switches.

Type	Ordering code
2 N 2221 A	Q62702-F414
2 N 2222 A	Q62702-S122

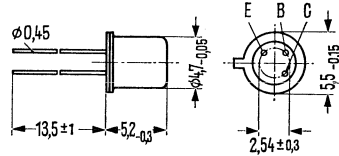

Approx. weight 0.3 g

Dimensions in mm

Maximum ratings

	2 N 2221 A	2 N 2222 A
Collector-emitter voltage	40	V
Collector-base voltage	75	V
Emitter-base voltage	6	V
Collector current	0.8	A
Junction temperature	175	°C
Storage temperature range	-65 to +200	°C
Total power dissipation ($T_{amb} = 25\text{ °C}$)	0.5	W
Total power dissipation ($T_{case} = 25\text{ °C}$)	1.8	W

Thermal resistance

Junction to ambient air	R_{thJA}	≤ 300	K/W
Junction to case	R_{thJC}	≤ 83	K/W

Static characteristics ($T_{amb} = 25\text{ }^{\circ}\text{C}$)

	2 N 2221 A	2 N 2222 A	
Collector-base breakdown voltage ($I_C = 10\text{ }\mu\text{A}$)	$V_{(BR)CBO} > 75$	> 75	V
Collector-emitter breakdown voltage ($I_C = 10\text{ mA}$)	$V_{(BR)CEO} > 40$	> 40	V
Emitter-base breakdown voltage ($I_E = 10\text{ }\mu\text{A}$)	$V_{(BR)EBO} > 6$	> 6	V
Collector-emitter saturation voltage ($I_B = 15\text{ mA}$; $I_C = 150\text{ mA}$)	$V_{CEsat} < 0.3$	< 0.3	V
($I_B = 50\text{ mA}$; $I_C = 500\text{ mA}$)	$V_{CEsat} < 1$	< 1	V
Base-emitter saturation voltage ($I_C = 150\text{ mA}$; $I_B = 15\text{ mA}$)	$V_{BEsat} < 1.2$	< 1.2	V
($I_C = 500\text{ mA}$; $I_B = 50\text{ mA}$)	$V_{BEsat} < 2$	< 2	V
Emitter cutoff current ($V_{EB} = 3\text{ V}$)	$I_{EBO} < 10$	< 10	nA
Collector-cutoff current ($V_{CB} = 60\text{ V}$)	$I_{CBO} < 10$	< 10	nA
($V_{CB} = 60\text{ V}$; $T_{amb} = 150\text{ }^{\circ}\text{C}$)	$I_{CBO} < 10$	< 10	μA
DC current gain ($V_{CE} = 10\text{ V}$; $I_C = 0.1\text{ mA}$)	$h_{FE} > 20$	> 35	-
($V_{CE} = 10\text{ V}$; $I_C = 1\text{ mA}$)	$h_{FE} > 25$	> 50	-
($V_{CE} = 10\text{ V}$; $I_C = 10\text{ mA}$)	$h_{FE} > 35$	> 75	-
($V_{CE} = 10\text{ V}$; $I_C = 150\text{ mA}$)	$h_{FE} 40\text{ to }120$	$100\text{ to }300$	-
($V_{CE} = 10\text{ V}$; $I_C = 500\text{ mA}$)	$h_{FE} > 25$	> 40	-
($V_{CE} = 1\text{ V}$; $I_C = 150\text{ mA}$)	$h_{FE} > 20$	> 50	-

Dynamic characteristics ($T_{amb} = 25\text{ }^{\circ}\text{C}$)

Collector base capacitance ($V_{CB} = 10\text{ V}$; $f = 100\text{ kHz}$)	$C_{CBO} < 8$	< 8	pF
Transition frequency ($V_{CE} = 20\text{ V}$; $I_C = 20\text{ mA}$; $f = 100\text{ MHz}$)	$f_T > 250$	> 300	MHz

Switching times:

($V_{CC} = 20\text{ V}$; $I_C = 150\text{ mA}$; I_{B1} approx. I_{B2} approx. 15 mA)			
Delay time	$t_d < 10$	< 10	ns
Rise time	$t_r < 25$	< 25	ns
Storage time	$t_s < 225$	< 225	ns
Fall time	$t_f < 60$	< 60	ns

2 N 2220
2 N 2221
2 N 2222
2 N 2221 A
2 N 2222 A

Total perm. power dissipation versus temperature

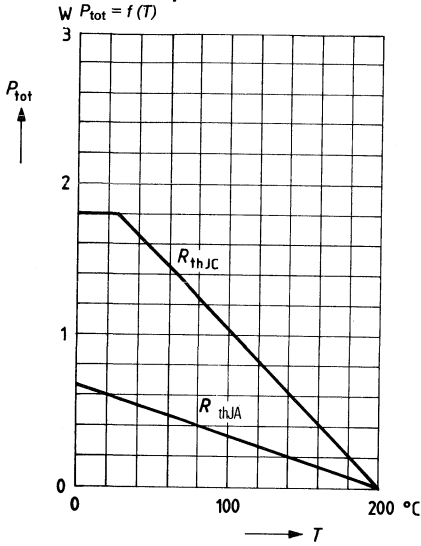

Permissible pulse load $r_{thJC} = f(t)$
 $v = \text{parameter}$

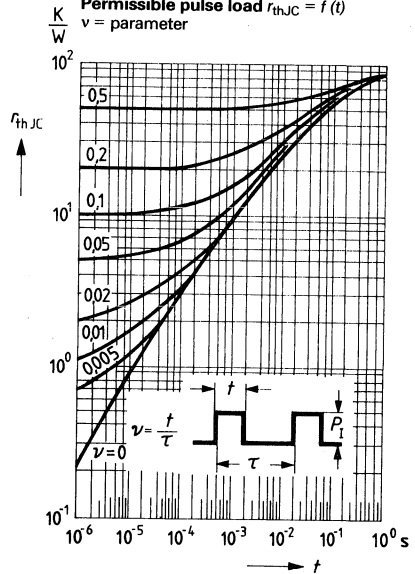

DC current gain $h_{FE} = f(I_C)$

$V_{CE} = 1 \text{ V}, V_{CE} = 10 \text{ V}; T_{amb} = 25^\circ \text{C}$

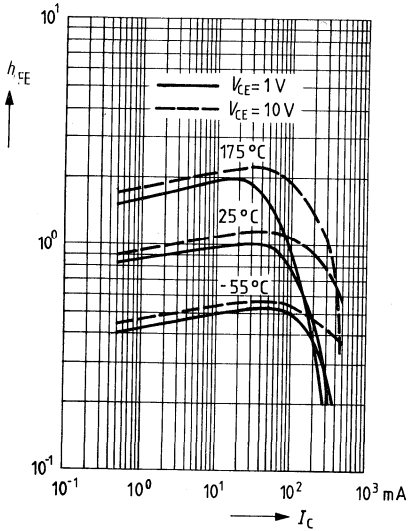

Saturation voltages

$V_{BEsat} = f(I_C), V_{CEsat} = f(I_C)$

$h_{FE} = 10; T_{amb} = 25^\circ \text{C}$

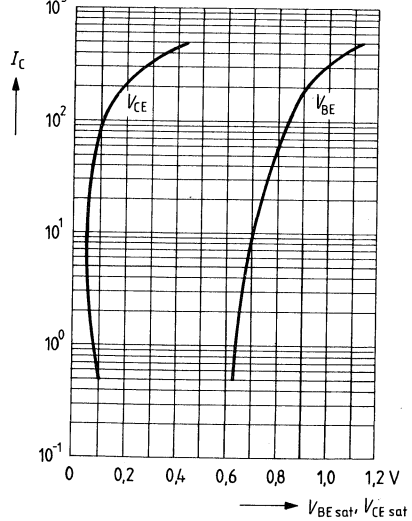

2 N 2220
2 N 2221
2 N 2222
2 N 2221 A
2 N 2222 A

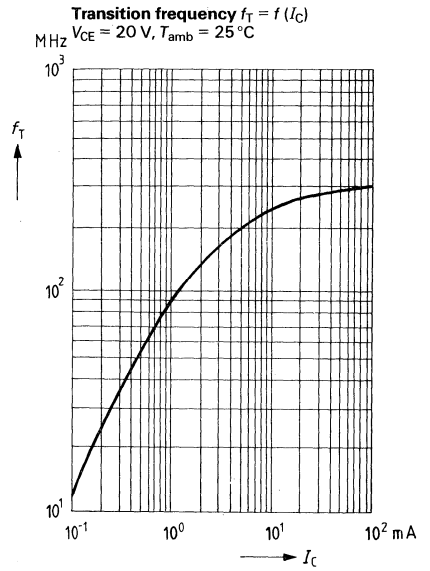
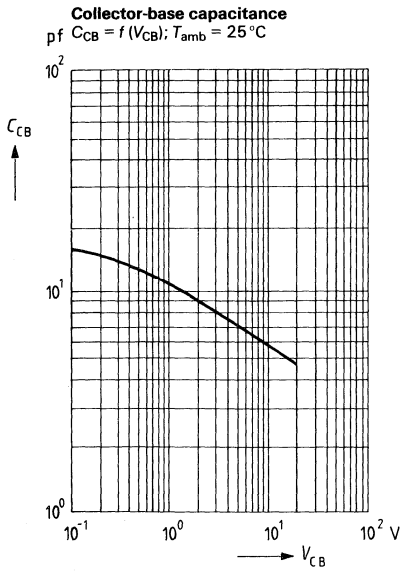
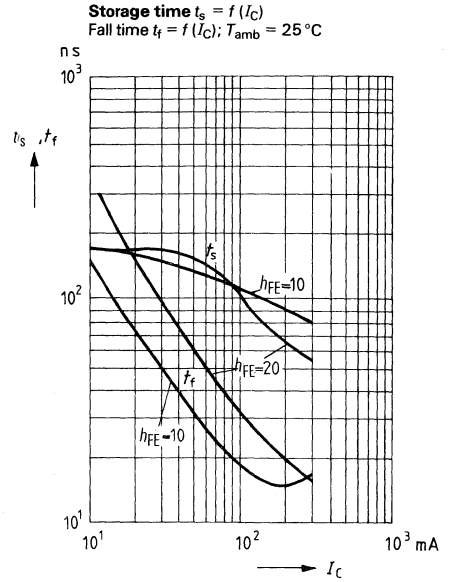
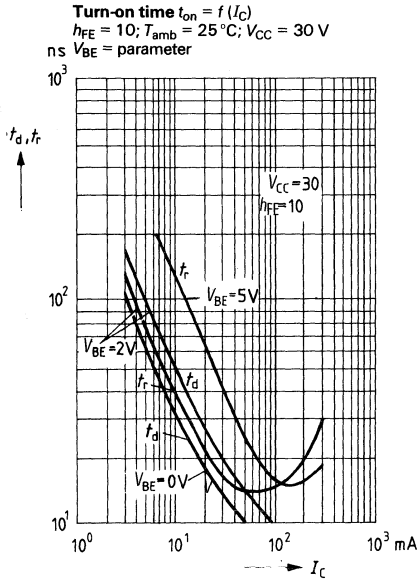

2 N 2904 and 2 N 2905 are epitaxial PNP silicon planar transistors in TO 39 case (5 C 3 DIN 41873). The collector is electrically connected to the case. The transistors are particularly suitable for use as high-speed switches.

Type	Ordering code
2 N 2904	Q62702-F65
2 N 2905	Q62702-F66

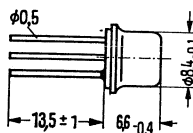

Approx. weight 1.5 g

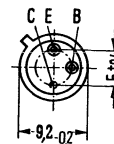

Dimensions in mm

Maximum ratings

Collector-base voltage	
Collector-emitter voltage	
Emitter-base voltage	
Collector current	
Junction temperature	
Storage temperature range	
Total power dissipation ($T_{amb} \leq 25^\circ\text{C}$)	
Total power dissipation ($T_{case} \leq 25^\circ\text{C}$)	

	2 N 2904 2 N 2905	
$-V_{CBO}$	60	V
$-V_{CEO}$	40	V
$-V_{EBO}$	5	V
$-I_C$	0.6	A
T_j	200	$^\circ\text{C}$
T_{stg}	-65 to +200	$^\circ\text{C}$
P_{tot}	0.6	W
P_{tot}	3	W

Thermal resistance

Junction to ambient air	
Junction to case	

R_{thJA}	< 188	K/W
R_{thJC}	< 50	K/W

Static characteristics ($T_{amb} = 25\text{ }^{\circ}\text{C}$)

	2 N 2904	2 N 2905	
Collector-base breakdown voltage ($-I_C = 10\text{ }\mu\text{A}$)	$-V_{(BR)CBO} > 60$	> 60	V
Collector-emitter breakdown voltage ($-I_C = 10\text{ mA}$)	$-V_{(BR)CEO} > 40$	> 40	V
Emitter-base breakdown voltage ($-I_E = 10\text{ }\mu\text{A}$)	$-V_{(BR)EBO} > 5$	> 5	V
Collector-emitter saturation voltage ($-I_C = 150\text{ mA}$, $I_B = 15\text{ mA}$)	$-V_{CEsat} < 0.4$	< 0.4	V
($-I_C = 500\text{ mA}$, $I_B = 50\text{ mA}$)	$-V_{CEsat} < 1.6$	< 1.6	V
Base-emitter saturation voltage ($-I_C = 150\text{ mA}$, $I_B = 15\text{ mA}$)	$-V_{BEsat} < 1.3$	< 1.3	V
($-I_C = 500\text{ mA}$, $I_B = 50\text{ mA}$)	$-V_{BEsat} < 2.6$	< 2.6	V
Collector cutoff current ($-V_{CB} = 50\text{ V}$)	$-I_{CBO} < 20$	< 20	nA
($-V_{CB} = 50\text{ V}$, $T_{amb} = 150\text{ }^{\circ}\text{C}$)	$-I_{CBO} < 20$	< 20	μA
DC current gain ($-V_{CE} = 10\text{ V}$, $-I_C = 0.1\text{ mA}$)	$h_{FE} > 20$	> 35	-
($-V_{CE} = 10\text{ V}$, $-I_C = 1\text{ mA}$)	$h_{FE} > 25$	> 50	-
($-V_{CE} = 10\text{ V}$, $-I_C = 10\text{ mA}$)	$h_{FE} > 35$	> 75	-
($-V_{CE} = 10\text{ V}$, $-I_C = 150\text{ mA}$)	$h_{FE} 40\text{ to }120$	$100\text{ to }300$	-
($-V_{CE} = 10\text{ V}$, $-I_C = 500\text{ mA}$)	$h_{FE} > 20$	> 30	-

Dynamic characteristics ($T_{amb} = 25\text{ }^{\circ}\text{C}$)

Transition frequency ($-V_{CE} = 20\text{ V}$, $-I_C = 50\text{ mA}$, $f = 100\text{ MHz}$)	$f_T > 200$	> 200	MHz
Collector-base capacitance ($-V_{CB} = 10\text{ V}$, $f = 100\text{ kHz}$)	$C_{CBO} < 8$	< 8	pF
Emitter-base capacitance ($-V_{EB} = 2\text{ V}$, $f = 100\text{ kHz}$)	$C_{CEO} < 30$	< 30	pF
Switching times:			
Delay time	$t_d < 10$	< 10	ns
Rise time	$t_r < 40$	< 40	ns
Turn-on time	$t_{on} < 45$	< 45	ns
Storage time	$t_s < 80$	< 80	ns
Fall time	$t_f < 30$	< 30	ns
Turn-off time	$t_{off} < 100$	< 100	ns

2 N 2904 A and 2 N 2905 A are epitaxial PNP silicon planar transistors in TO 39 case (5 C 3 DIN 41873). The collector is electrically connected to the case. The transistors are particularly suitable for use as high-speed switches.

Type	Ordering code
2 N 2904 A	Q62702-F91
2 N 2905 A	Q62702-F92

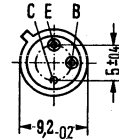
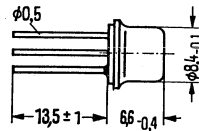

Approx. weight 1.5 g

Dimensions in mm

Maximum ratings

Collector-base voltage
Collector-emitter voltage
Emitter-base voltage
Collector current
Junction temperature
Storage temperature range
Total power dissipation ($T_{amb} \leq 25\text{ }^{\circ}\text{C}$)
Total power dissipation ($T_{case} \leq 25\text{ }^{\circ}\text{C}$)

	2 N 2904 A	2 N 2905 A
$-V_{CBO}$	60	V
$-V_{CEO}$	60	V
$-V_{EBO}$	5	V
$-I_C$	0.6	A
T_j	200	$^{\circ}\text{C}$
T_{stg}	-65 to +200	$^{\circ}\text{C}$
P_{tot}	0.6	W
P_{tot}	3	W

Thermal resistance

Junction to ambient air
Junction to case

R_{thJA}	< 188	K/W
R_{thJC}	< 50	K/W

Static characteristics ($T_{amb} = 25^\circ\text{C}$)

	2 N 2904 A	2 N 2905 A	
Collector-base breakdown voltage ($-I_C = 10 \mu\text{A}$)	$-V_{(BR)CBO} > 60$	> 60	V
Collector-emitter breakdown voltage ($-I_C = 10 \text{ mA}$)	$-V_{(BR)CEO} > 60$	> 60	V
Emitter-base breakdown voltage ($-I_E = 10 \mu\text{A}$)	$-V_{(BR)EBO} > 5$	> 5	V
Collector-emitter saturation voltage ($-I_C = 150 \text{ mA}, I_B = 15 \text{ mA}$)	$-V_{CEsat} < 0.4$	< 0.4	V
($-I_C = 500 \text{ mA}, I_B = 50 \text{ mA}$)	$-V_{CEsat} < 1.6$	< 1.6	V
Base-emitter saturation voltage ($-I_C = 150 \text{ mA}, I_B = 15 \text{ mA}$)	$-V_{BEsat} < 1.3$	< 1.3	V
($-I_C = 500 \text{ mA}, I_B = 50 \text{ mA}$)	$-V_{BEsat} < 2.6$	< 2.6	V
Collector cutoff current ($-V_{CB} = 50 \text{ V}$)	$-I_{CBO} < 10$	< 10	nA
($-V_{CB} = 50 \text{ V}, T_{amb} = 150^\circ\text{C}$)	$-I_{CBO} < 10$	< 10	μA
DC current gain ($-V_{CE} = 10 \text{ V}, -I_C = 0.1 \text{ mA}$)	$h_{FE} > 40$	> 75	-
($-V_{CE} = 10 \text{ V}, -I_C = 1 \text{ mA}$)	$h_{FE} > 40$	> 100	-
($-V_{CE} = 10 \text{ V}, -I_C = 10 \text{ mA}$)	$h_{FE} > 40$	> 100	-
($-V_{CE} = 10 \text{ V}, -I_C = 150 \text{ mA}$)	$h_{FE} 40 \text{ to } 120$	$100 \text{ to } 300$	-
($-V_{CE} = 10 \text{ V}, -I_C = 500 \text{ mA}$)	$h_{FE} > 40$	> 50	-

Dynamic characteristics ($T_{amb} = 25^\circ\text{C}$)

Transition frequency ($-V_{CE} = 20 \text{ V}, -I_C = 50 \text{ mA}, f = 100 \text{ MHz}$)	$f_T > 200$	> 200	MHz
Collector-base capacitance ($-V_{CB} = 10 \text{ V}, f = 100 \text{ kHz}$)	$C_{CBO} < 8$	< 8	pF
Emitter-base capacitance ($-V_{EB} = 2 \text{ V}, f = 100 \text{ kHz}$)	$C_{CEO} < 30$	< 30	pF
Switching times:			
Delay time	$t_d < 10$	< 10	ns
Rise time	$t_r < 40$	< 40	ns
Turn-on time	$t_{on} < 45$	< 45	ns
Storage time	$t_s < 80$	< 80	ns
Fall time	$t_f < 30$	< 30	ns
Turn-off time	$t_{off} < 100$	< 100	ns

2 N 2904
2 N 2905
2 N 2904 A
2 N 2905 A

Total perm. power dissipation versus temperature
 $P_{tot} = f(T)$

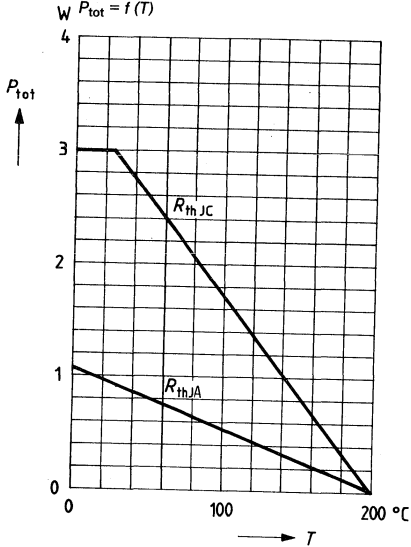

Permissible pulse load $r_{thJC} = f(t)$
 $v = \text{parameter}$

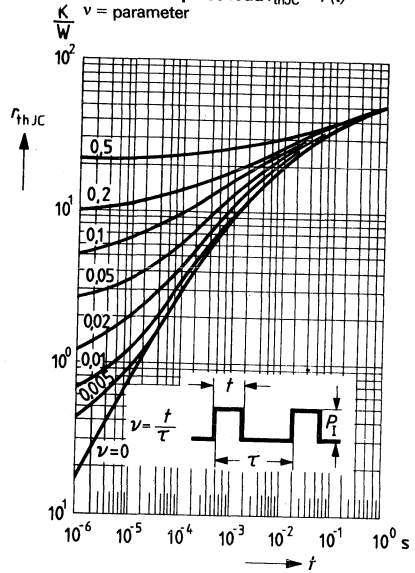

DC current gain $h_{FE} = f(I_C)$
 $V_{CE} = 1V, V_{CE} = 10V; T_{amb} = 25^\circ C$

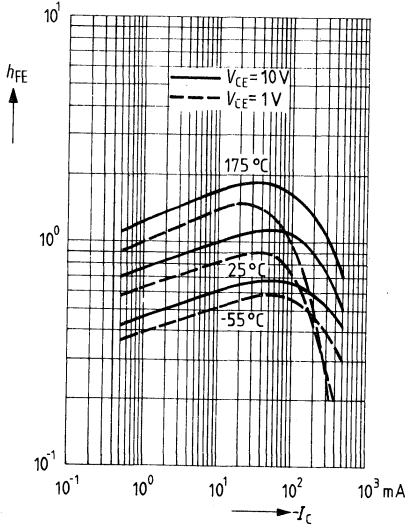

Saturation voltages
 $V_{BEsat} = f(I_C), V_{CEsat} = f(I_C)$
 $h_{FE} = 10; T_{amb} = 25^\circ C$

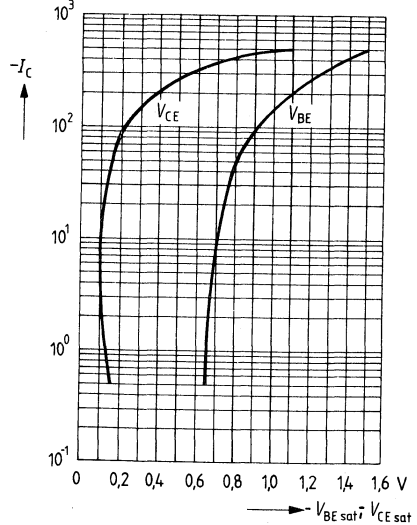

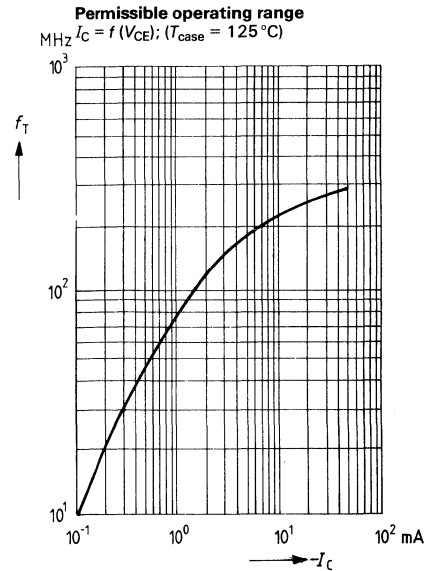
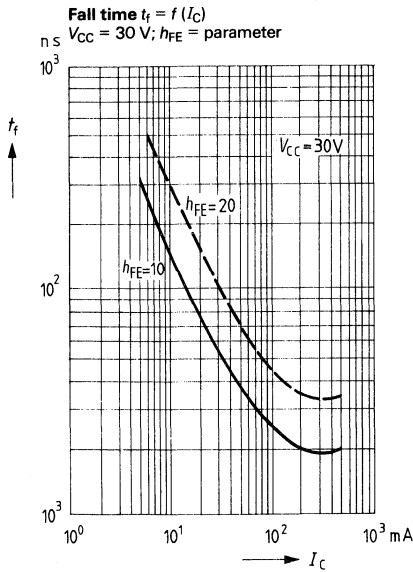
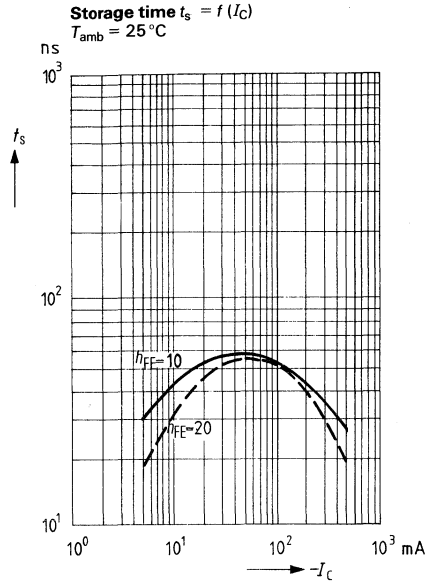
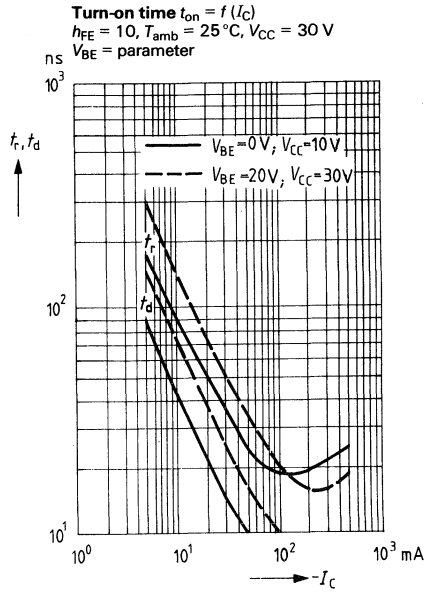

2 N 2904
2 N 2905
2 N 2904 A
2 N 2905 A

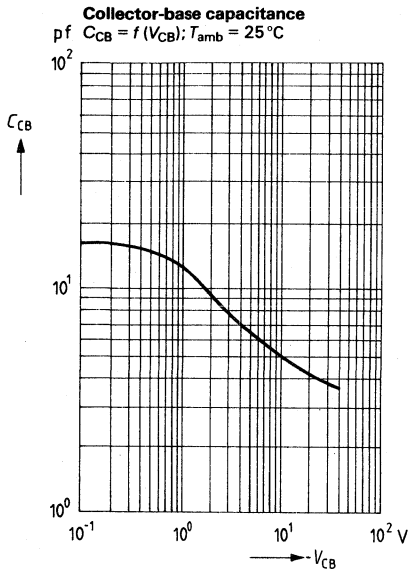

PNP Silicon Planar Transistors

2 N 2906
2 N 2907

2 N 2906 and 2 N 2907 are epitaxial PNP silicon planar transistors in TO 18 case (18 A 3 DIN 41876). The collector is electrically connected to the case. The transistors are particularly suitable for use as high-speed switches.

Type	Ordering code
2 N 2906	Q62702-F137
2 N 2907	Q62702-S111

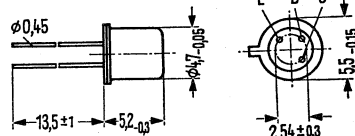

Approx. weight 0.3 g

Dimensions in mm

Maximum ratings

Collector-emitter voltage
Collector-base voltage
Emitter-base voltage
Collector current
Junction temperature
Storage temperature range
Total power dissipation ($T_{amb} = 25\text{ }^{\circ}\text{C}$)
Total power dissipation ($T_{case} = 25\text{ }^{\circ}\text{C}$)

	2 N 2906	2 N 2907	
$-V_{CEO}$	40		V
$-V_{CBO}$	60		V
$-V_{EBO}$	5		V
$-I_C$	0.6		A
T_j	200		$^{\circ}\text{C}$
T_{stg}	-65 to +200		$^{\circ}\text{C}$
P_{tot}	0.4		W
P_{tot}	1.8		W

Thermal resistance

Junction to ambient air
Junction to case

R_{thJA}	< 438	K/W
R_{thJC}	< 97	K/W

Static characteristics ($T_{amb} = 25\text{ }^{\circ}\text{C}$)

		2 N 2906	2 N 2907	
Collector-base breakdown voltage ($-I_C = 10\text{ }\mu\text{A}$)	$-V_{(BR)CBO}$	> 60	> 60	V
Collector-emitter breakdown voltage ($-I_C = 10\text{ mA}$)	$-V_{(BR)CEO}$	> 40	> 40	V
Emitter-base breakdown voltage ($-I_E = 5\text{ V}$)	$-V_{(BR)EBO}$	> 5	> 5	V
Collector-emitter saturation voltage ($-I_B = 15\text{ mA}$; $-I_C = 150\text{ mA}$)	$-V_{CEsat}$	< 0.4	< 0.4	V
($-I_B = 50\text{ mA}$; $-I_C = 500\text{ mA}$)	$-V_{CEsat}$	< 1.6	< 1.6	V
Base-emitter saturation voltage ($-I_C = 150\text{ mA}$; $-I_B = 15\text{ mA}$)	$-V_{BEsat}$	< 1.3	< 1.3	V
($-I_C = 500\text{ mA}$; $-I_B = 50\text{ mA}$)	$-V_{BEsat}$	< 2.6	< 2.6	V
Collector cutoff current ($-V_{CB} = 50\text{ V}$)	$-I_{CBO}$	< 20	< 20	nA
($-V_{CB} = 50\text{ V}$; $T_{amb} = 150\text{ }^{\circ}\text{C}$)	$-I_{CBO}$	< 20	< 20	μA
DC current gain ($-V_{CE} = 10\text{ V}$; $-I_C = 100\text{ }\mu\text{A}$)	h_{FE}	> 20	> 35	-
($-V_{CE} = 10\text{ V}$; $-I_C = 1\text{ mA}$)	h_{FE}	> 25	> 50	-
($-V_{CE} = 10\text{ V}$; $-I_C = 10\text{ mA}$)	h_{FE}	> 35	> 75	-
($-V_{CE} = 10\text{ V}$; $-I_C = 150\text{ mA}$)	h_{FE}	40 to 120	100 to 300	-
($-V_{CE} = 10\text{ V}$; $-I_C = 500\text{ mA}$)	h_{FE}	> 20	> 30	-

Dynamic characteristics ($T_{amb} = 25\text{ }^{\circ}\text{C}$)

Collector base capacitance ($-V_{CB} = 10\text{ V}$; $f = 100\text{ kHz}$)	C_{CBO}	< 8	< 8	pF
Transition frequency ($-V_{CE} = 20\text{ V}$; $-I_C = 50\text{ mA}$; $f = 100\text{ MHz}$)	f_T	> 200	> 200	MHz

Switching times:

($-V_{CC} = 30\text{ V}$; $-I_C = 150\text{ mA}$; I_{B1} approx. I_{B2} approx. 15 mA)				
Delay time	t_d	< 10	< 10	ns
Rise time	t_r	< 40	< 40	ns
Storage time	t_s	< 80	< 80	ns
Fall time	t_f	< 30	< 30	ns

PNP Silicon Planar Transistors

2 N 2906 A
2 N 2907 A

2 N 2906 A and 2 N 2907 A are epitaxial PNP silicon planar transistors in TO 18 case (18 A 3 DIN 41876). The collector is electrically connected to the case. The transistors are particularly suitable for use as high-speed switches.

Type	Ordering code
2 N 2906 A	Q62702-F408
2 N 2907 A	Q62702-S170

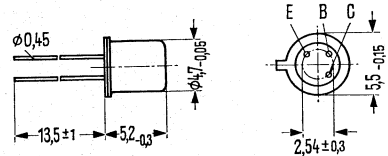

Approx. weight 0.3 g

Dimensions in mm

Maximum ratings

Collector-emitter voltage
Collector-base voltage
Emitter-base voltage
Collector current
Junction temperature
Storage temperature range
Total power dissipation ($T_{amb} = 25\text{ °C}$)
Total power dissipation ($T_{case} = 25\text{ °C}$)

	2 N 2906 A	2 N 2907 A
$-V_{CEO}$	60	V
$-V_{CBO}$	60	V
$-V_{EBO}$	5	V
$-I_C$	0.6	A
T_j	200	°C
T_{stg}	-65 to +200	°C
P_{tot}	0.4	W
P_{tot}	1.8	W

Thermal resistance

Junction to ambient air
Junction to case

R_{thJA}	< 438	K/W
R_{thJC}	< 97	K/W

Static characteristics ($T_{amb} = 25\text{ }^{\circ}\text{C}$)

		2 N 2906 A	2 N 2907 A	
Collector-base breakdown voltage ($-I_C = 10\text{ }\mu\text{A}$)	$-V_{(BR)CBO}$	> 60	> 60	V
Collector-emitter breakdown voltage ($-I_C = 10\text{ mA}$)	$-V_{(BR)CEO}$	> 60	> 60	V
Emitter-base breakdown voltage ($-I_E = 10\text{ }\mu\text{A}$)	$-V_{(BR)EBO}$	> 5	> 5	V
Collector-emitter saturation voltage ($-I_B = 15\text{ mA}$; $-I_C = 150\text{ mA}$)	$-V_{CEsat}$	< 0.4	< 0.4	V
($-I_B = 50\text{ mA}$; $-I_C = 500\text{ mA}$)	$-V_{CEsat}$	< 1.6	< 1.6	V
Base-emitter saturation voltage ($-I_C = 150\text{ mA}$; $-I_B = 15\text{ mA}$)	$-V_{BEsat}$	< 1.3	< 1.3	V
($-I_C = 500\text{ mA}$; $-I_B = 50\text{ mA}$)	$-V_{BEsat}$	< 2.6	< 2.6	V
Collector cutoff current ($-V_{CB} = 50\text{ V}$)	$-I_{CBO}$	< 10	< 10	nA
($-V_{CB} = 50\text{ V}$; $T_{amb} = 150\text{ }^{\circ}\text{C}$)	$-I_{CBO}$	< 10	< 10	μA
DC current gain ($-V_{CE} = 10\text{ V}$; $-I_C = 100\text{ }\mu\text{A}$)	h_{FE}	> 40	> 75	—
($-V_{CE} = 10\text{ V}$; $-I_C = 1\text{ mA}$)	h_{FE}	> 40	> 100	—
($-V_{CE} = 10\text{ V}$; $-I_C = 10\text{ mA}$)	h_{FE}	> 40	> 100	—
($-V_{CE} = 10\text{ V}$; $-I_C = 150\text{ mA}$)	h_{FE}	40 to 120	100 to 300	—
($-V_{CE} = 10\text{ V}$; $-I_C = 500\text{ mA}$)	h_{FE}	> 40	> 50	—

Dynamic characteristics ($T_{amb} = 25\text{ }^{\circ}\text{C}$)

Collector-base capacitance ($-V_{CB} = 10\text{ V}$; $f = 100\text{ kHz}$)	C_{CBO}	< 8	< 8	pF
Transition frequency ($-V_{CE} = 20\text{ V}$; $-I_C = 50\text{ mA}$; $f = 100\text{ MHz}$)	f_T	> 200	> 200	MHz
Switching times:				
($-V_{CC} = 30\text{ V}$; $-I_C = 150\text{ mA}$; I_{B1} approx. $-I_{B2}$ approx. 15 mA)				
Delay time	t_d	< 10	< 10	ns
Rise time	t_r	< 40	< 40	ns
Storage time	t_s	< 80	< 80	ns
Fall time	t_f	< 30	< 30	ns

2 N 2906
2 N 2907
2 N 2906 A
2 N 2907 A

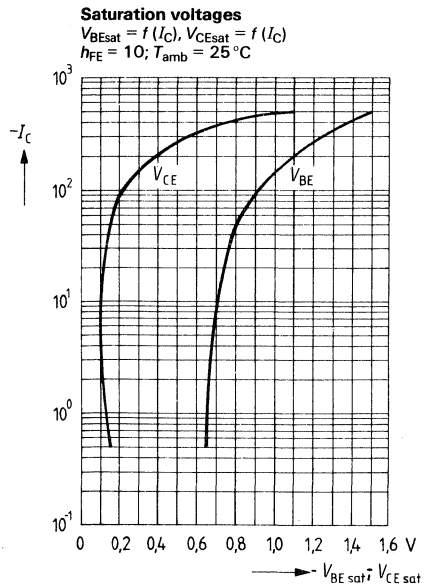
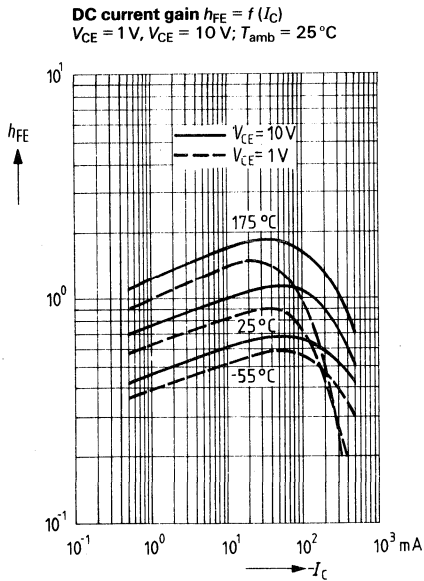
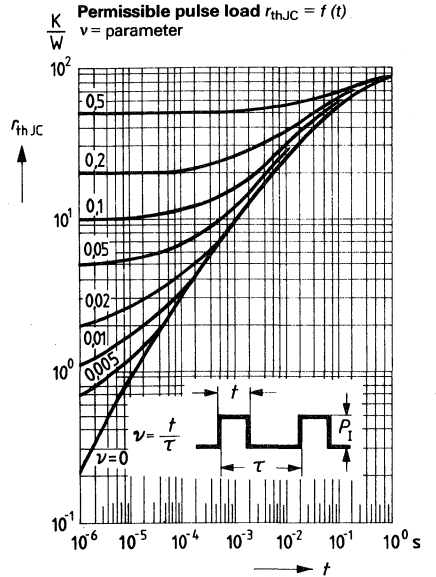
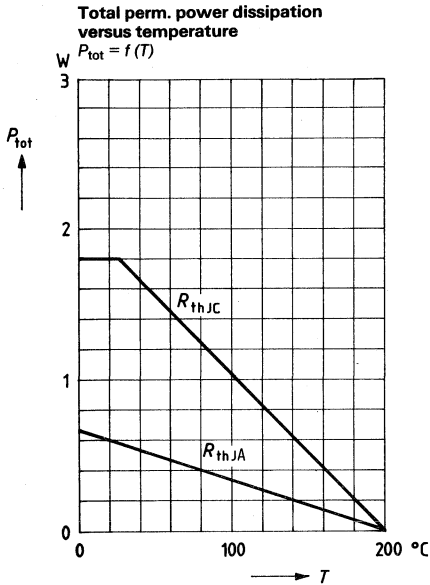

2 N 2906
2 N 2907
2 N 2906 A
2 N 2907 A

Turn-on time $t_{on} = f(I_C)$
 $h_{FE} = 10; T_{amb} = 25^\circ C; V_{CC} = 30 V$
 $V_{BE} = \text{parameter}$

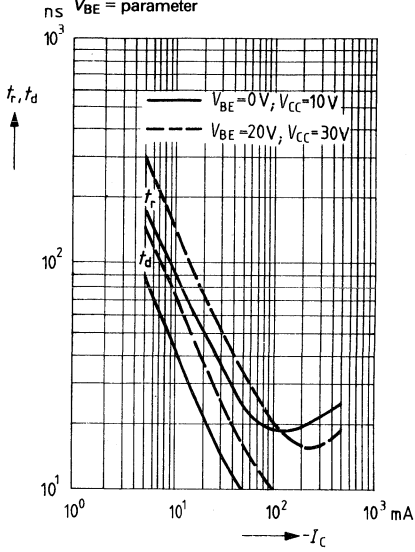

Storage time $t_s = f(I_C)$
Fall time $t_f = f(I_C); T_{amb} = 25^\circ C$

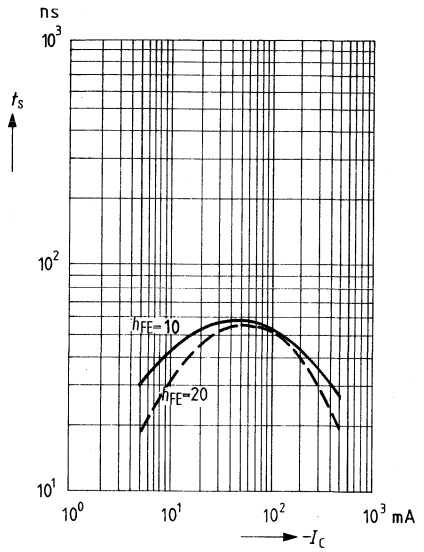

Fall time $t_f = f(I_C)$
 $V_{CC} = 30 V; h_{FE} = \text{parameter}$

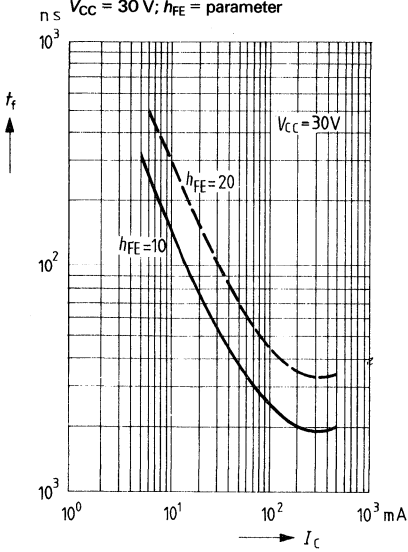

Transition frequency $f_T = f(I_C)$
 $V_{CE} = 20 V, T_{amb} = 25^\circ C$

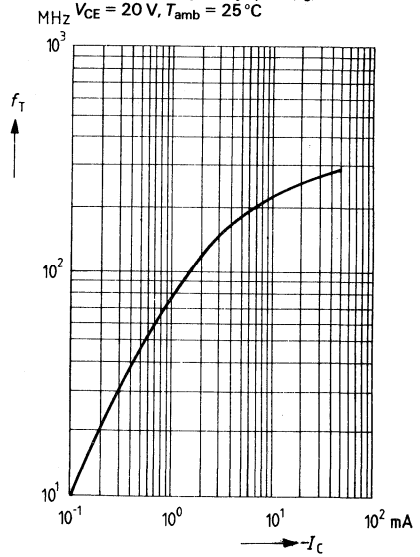

2 N 2906
2 N 2907
2 N 2906 A
2 N 2907 A

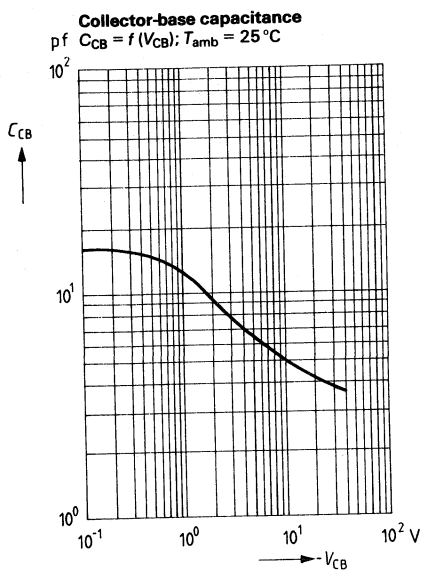

2 N 3019 is an epitaxial NPN silicon planar transistor in TO 39 case (5 C 3 DIN 41873). The collector is electrically connected to the case. The transistor is particularly suitable for use in Af amplifiers and for AF switching applications.

Type	Ordering code
2 N 3019	Q68000-A627

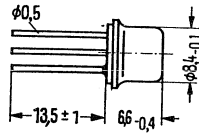

Approx. weight 1.5 g

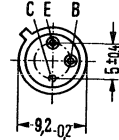

Dimensions in mm

Maximum ratings

Collector-base voltage	V_{CBO}	140	V
Collector-emitter voltage	V_{CEO}	80	V
Emitter-base voltage	V_{EBO}	7	V
Collector current	I_C	1	A
Junction temperature	T_j	200	°C
Storage temperature range	T_{stg}	-65 to +200	°C
Total power dissipation ($T_{amb} \leq 25\text{ °C}$)	P_{tot}	0.8	W
Total power dissipation ($T_{case} \leq 25\text{ °C}$)	P_{tot}	5	W

Thermal resistance

Junction to ambient air	R_{thJA}	≤ 218	K/W
Junction to case	R_{thJC}	≤ 35	K/W

Static characteristics ($T_{amb} = 25\text{ }^{\circ}\text{C}$)

Collector-base breakdown voltage ($I_C = 100\text{ }\mu\text{A}$)	$V_{(BR)CBO}$	> 140	V
Collector-emitter breakdown voltage ($I_C = 30\text{ mA}$)	$V_{(BR)CEO}$	> 80	V
Emitter-base breakdown voltage ($I_E = 100\text{ }\mu\text{A}$)	$V_{(BR)EBO}$	> 7	V
Collector-emitter saturation voltage ($I_C = 150\text{ mA}$, $I_B = 15\text{ mA}$)	V_{CEsat}	< 0.2	V
($I_C = 500\text{ mA}$, $I_B = 50\text{ mA}$)	V_{CEsat}	< 0.5	V
Base-emitter saturation voltage ($I_C = 150\text{ mA}$, $I_B = 15\text{ mA}$)	V_{BEsat}	< 1.1	V
Collector cutoff current ($V_{CBO} = 90\text{ V}$)	I_{CBO}	< 10	nA
($V_{CBO} = 90\text{ V}$, $T_{amb} = 150\text{ }^{\circ}\text{C}$)	I_{CBO}	< 10	μA
Emitter cutoff current ($V_{EBO} = 5\text{ V}$)	I_{EBO}	< 10	nA
DC current gain ($V_{CE} = 10\text{ V}$, $I_C = 0.1\text{ mA}$)	h_{FE}	> 50	–
($V_{CE} = 10\text{ V}$, $I_C = 10\text{ mA}$)	h_{FE}	> 90	–
($V_{CE} = 10\text{ V}$, $I_C = 150\text{ mA}$)	h_{FE}	100 to 300	–
($V_{CE} = 10\text{ V}$, $I_C = 500\text{ mA}$)	h_{FE}	> 50	–
($V_{CE} = 10\text{ V}$, $I_C = 1\text{ A}$)	h_{FE}	> 15	–
($V_{CE} = 10\text{ V}$; $I_C = 150\text{ mA}$; $T_{amb} = -55\text{ }^{\circ}\text{C}$)	h_{FE}	> 40	–

Dynamic characteristics ($T_{amb} = 25\text{ }^{\circ}\text{C}$)

Transition frequency ($V_{CE} = 10\text{ V}$, $I_C = 50\text{ mA}$, $f = 20\text{ MHz}$)	f_T	> 100	MHz
Collector base capacitance ($V_{CBO} = 10\text{ V}$, $f = 1\text{ MHz}$)	C_{CBO}	< 12	pF
Emitter base capacitance ($V_{EBO} = 0.5\text{ V}$, $f = 1\text{ MHz}$)	C_{EBO}	< 60	pF
Small signal current gain ($I_C = 1\text{ mA}$, $V_{CE} = 5\text{ V}$, $f = 1\text{ kHz}$)	h_{fe}	80 to 400	–
Feedback time constant ($V_{CE} = 10\text{ V}$, $I_C = 10\text{ mA}$, $f = 4\text{ MHz}$)	$r_{bb'} \cdot C_{bc}$	< 400	ps
Noise figure ($I_C = 100\text{ }\mu\text{A}$, $V_{CE} = 10\text{ V}$, $f = 1\text{ kHz}$, $R_g = 1\text{ k}\Omega$)	NF	< 4	dB
Switching times ($I_C = 500\text{ mA}$; $I_{B1} = I_{B2} = 50\text{ mA}$)			
Turn-on time	t_{on}	< 100	ns
Turn-off time	t_{off}	< 500	ns

Total perm. power dissipation versus temperature

$P_{tot} = f(T); V_{CE} = \text{parameter}$

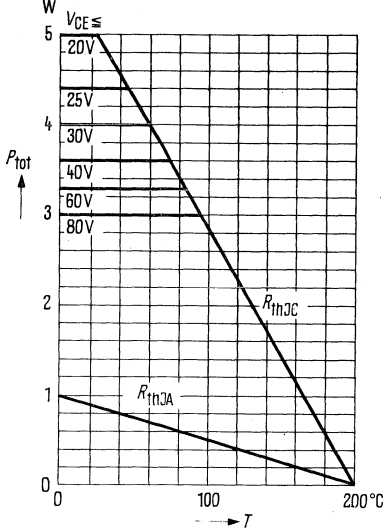

Permissible pulse load

$r_{thJC} = f(f); v = \text{parameter}$

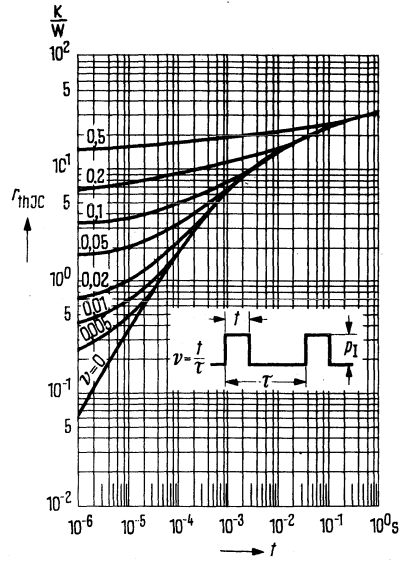

Permissible operating range

$I_C = f(V_{CE}); (T_{case} = 60^{\circ}\text{C})$

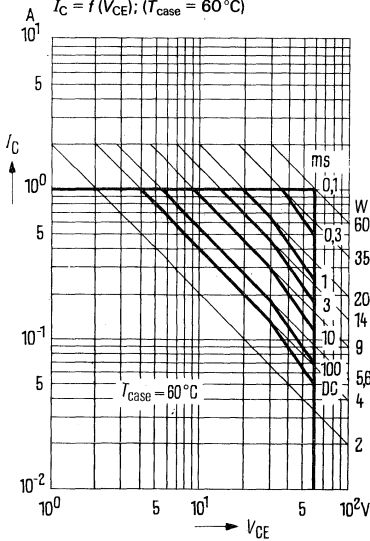

Permissible operating range

$I_C = f(V_{CE}); (T_{case} = 125^{\circ}\text{C})$

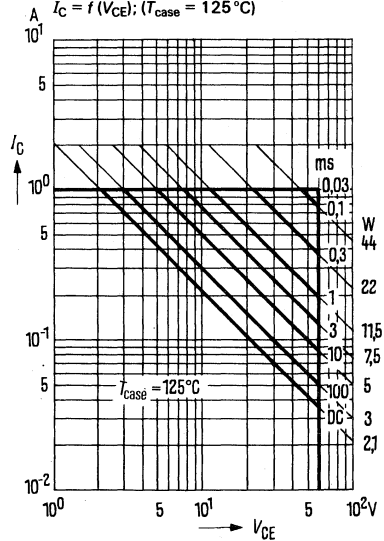

DC current gain $h_{FE} = f(I_C)$
 $V_{CE} = 10\text{ V}; T_{amb} = \text{parameter}$

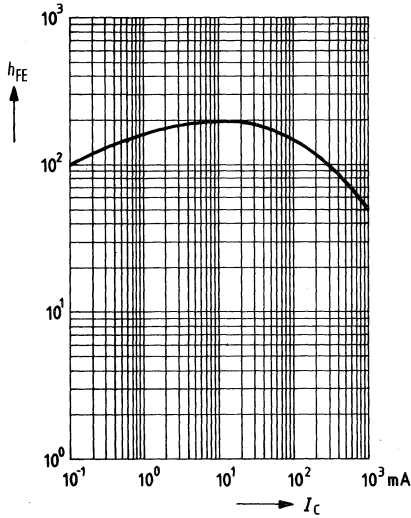

Collector cutoff current versus temperature $I_{CBO} = f(T_{amb})$
 $V_{CBO} = 90\text{ V}$

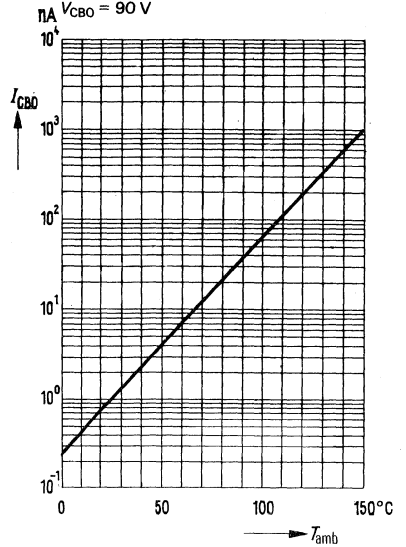

Collector-emitter saturation voltage $V_{CEsat} = f(I_C)$
 $h_{FE} = 10$

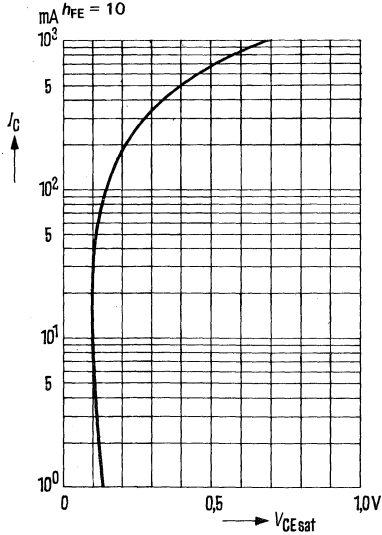

Base-emitter saturation voltage $V_{BEsat} = f(I_C)$
 $h_{FE} = 10; V_{CE} = 1\text{ V}$

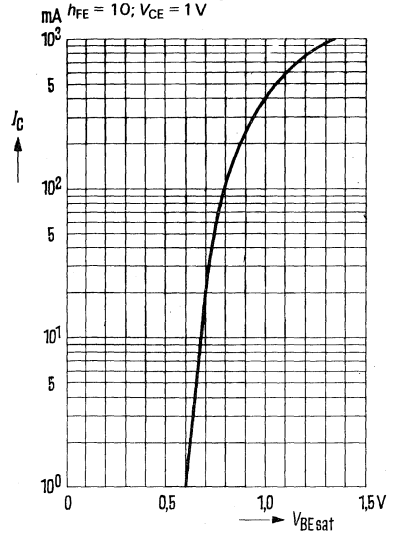

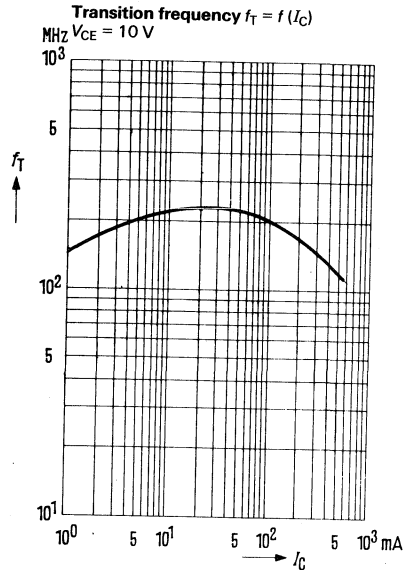
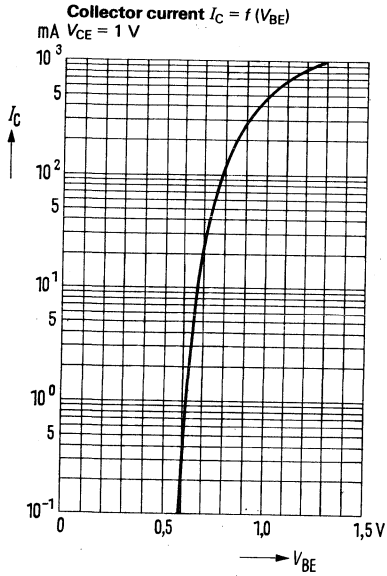

Test circuit for switching times

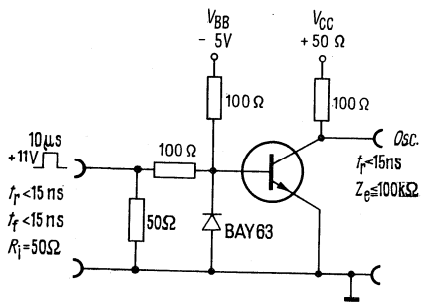

NPN Transistor for Powerful AF Output Stages

2 N 3055

2 N 3055 is a single diffused NPN silicon transistor in TO 3 case (3 A 2 DIN 41872). The collector is electrically connected to the case. The transistor is particularly suitable for use in powerful AF output stages and in stabilized power supply units. One mica washer and two insulating nipples are provided for the insulated mounting of this transistor on a chassis; they are to be ordered separately.

Type	Ordering code
2 N 3055	Q62702-U58

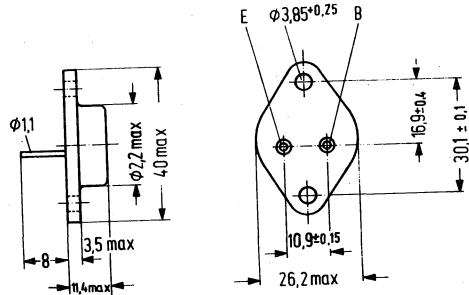

Approx. weight 18 g

Dimensions in mm

Maximum ratings

Collector-base voltage	V_{CBO}	100	V
Collector-emitter voltage ($V_{BE} = -1.5$ V; $I_C = 10$ mA)	V_{CEV}	90	V
Collector-emitter voltage ($R_{BE} = 100$ Ω ; $I_C = 200$ mA)	V_{CER}	70	V
Collector-emitter voltage	V_{CEO}	60	V
Emitter-base voltage	V_{EBO}	7	V
Collector current	I_C	15	A
Base current	I_B	7	A
Junction temperature	T_j	200	$^{\circ}$ C
Storage temperature range	T_{stg}	-65 to +200	$^{\circ}$ C
Total power dissipation ($T_{case} = 25$ $^{\circ}$ C)	P_{tot}	115	W

Thermal resistance

Junction to case	R_{thJC}	≤ 1.5	K/W
------------------	------------	------------	-----

Static characteristics ($T_{\text{case}} = 25\text{ }^{\circ}\text{C}$)

Collector cutoff current ($V_{\text{CE}} = 30\text{ V}$)	I_{CEO}	< 0.7	mA
Collector cutoff current ($V_{\text{CEV}} = 100\text{ V}$; $V_{\text{BE}} = -1.5\text{ V}$)	I_{CEV}	< 5	mA
Collector cutoff current ($V_{\text{CEV}} = 100\text{ V}$; $V_{\text{BE}} = -1.5\text{ V}$; $T_{\text{case}} = 150\text{ }^{\circ}\text{C}$)	I_{CEV}	< 30	mA
Emitter cutoff current ($V_{\text{EBO}} = 7\text{ V}$)	I_{EBO}	< 5	mA
Collector-emitter breakdown voltage ($I_{\text{C}} = 200\text{ mA}$)	$V_{(\text{BR})\text{CEO}}$	> 60	V
Collector-emitter breakdown voltage ($I_{\text{C}} = 100\text{ mA}$; $V_{\text{BE}} = -1.5\text{ V}$)	V_{CEV}	> 90	V
Collector-emitter breakdown voltage ($I_{\text{C}} = 200\text{ mA}$; $R_{\text{BE}} = 100\text{ }\Omega$)	V_{CER}	> 70	V
Base-emitter voltage ($I_{\text{C}} = 4\text{ A}$; $V_{\text{CE}} = 4\text{ V}$)	V_{BE}	< 1.8	V
Collector-emitter saturation voltage ($I_{\text{C}} = 4\text{ A}$; $I_{\text{B}} = 0.4\text{ A}$)	V_{CEsat}	< 1.1	V
($I_{\text{C}} = 10\text{ A}$; $I_{\text{B}} = 3.3\text{ A}$)	V_{CEsat}	< 8	V
DC current gain ($I_{\text{C}} = 4\text{ A}$; $V_{\text{CE}} = 4\text{ V}$)	h_{FE}	20 to 70	–

Dynamic characteristics ($T_{\text{case}} = 25\text{ }^{\circ}\text{C}$)

Transition frequency ($I_{\text{C}} = 1\text{ A}$)	f_{T}	> 0.8	MHz
h_{fe} cutoff frequency ($I_{\text{C}} = 1\text{ A}$; $V_{\text{CE}} = 4\text{ V}$)	f_{hfe}	> 10	kHz

Permissible operating range
 $I_C = f(V_{CE}); T_{case} = 25^\circ\text{C}; v = 0$

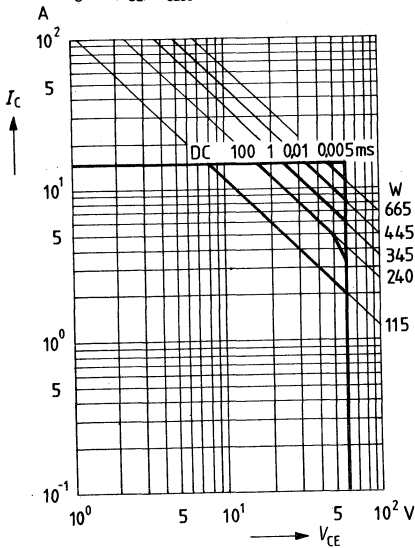

Total perm. power dissipation versus temperature
 $P_{tot} = f(T_{case})$

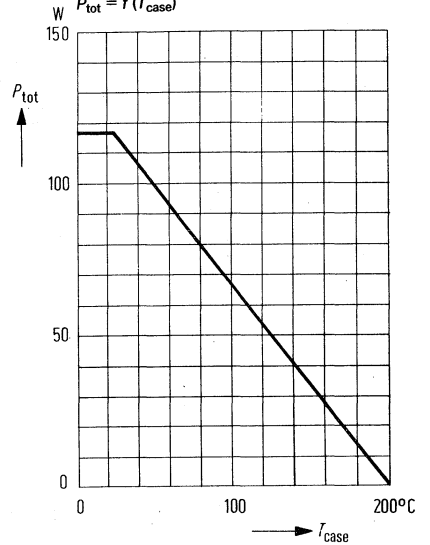

Collector current $I_C = f(V_{BE})$
 $V_{CE} = 4\text{ V}; T_{case} = \text{parameter}$
 (common-emitter configuration)

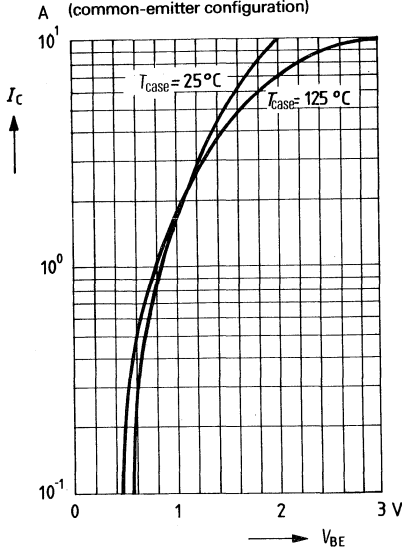

DC current gain $h_{FE} = f(I_C)$
 $V_{CE} = 4\text{ V}; T_{case} = \text{parameter}$

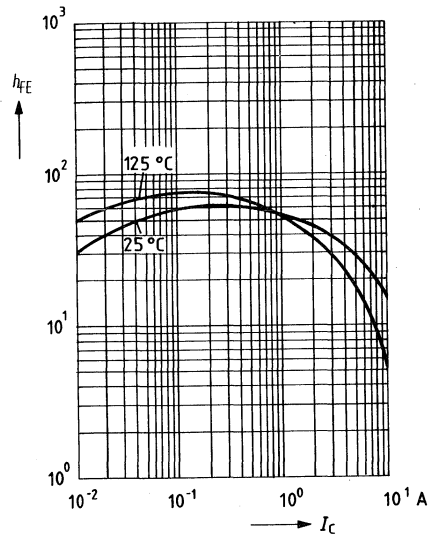

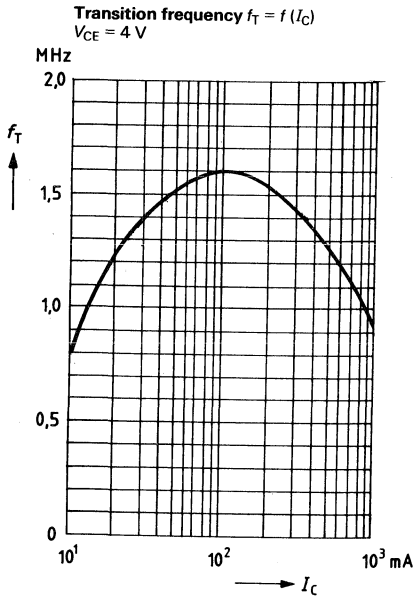

2 N 4033 is an epitaxial PNP silicon planar transistor in TO 39 case (5 C 3 DIN 41873). The collector is electrically connected to the case. The transistor is particularly intended for use in AF amplifiers and for AF switching applications up to 1 A.

Type	Ordering code
2 N 4033	Q62702-S154

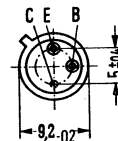
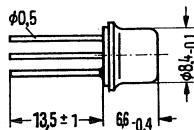

Approx. weight 1.5 g

Dimensions in mm

Maximum ratings

Collector-base voltage	$-V_{CB0}$	80	V
Collector-emitter voltage	$-V_{CE0}$	80	V
Emitter-base voltage	$-V_{EB0}$	5	V
Collector current	$-I_C$	1	A
Junction temperature	T_j	200	°C
Storage temperature range	T_{stg}	-65 to +200	°C
Total power dissipation ($T_{amb} \leq 25\text{ °C}$)	P_{tot}	0.8	W
Total power dissipation ($T_{case} \leq 25\text{ °C}$)	P_{tot}	4	W

Thermal resistance

Junction to ambient air	R_{thJA}	≤ 220	K/W
Junction to case	R_{thJC}	≤ 44	K/W

Static characteristics ($T_{amb} = 25\text{ }^{\circ}\text{C}$)

Collector-base breakdown voltage ($-I_C = 10\text{ }\mu\text{A}$)	$-V_{(BR)CBO}$	> 80	V
Collector-emitter breakdown voltage ($-I_C = 10\text{ mA}$)	$-V_{(BR)CEO}$	> 80	V
Emitter-base breakdown voltage ($-I_E = 10\text{ }\mu\text{A}$)	$-V_{(BR)EBO}$	> 5	V
Collector-emitter saturation voltage ($-I_C = 150\text{ mA}$, $-I_B = 15\text{ mA}$)	$-V_{CEsat}$	< 0.15	V
($-I_C = 500\text{ mA}$, $-I_B = 50\text{ mA}$)	$-V_{CEsat}$	< 0.5	V
Base-emitter saturation voltage ($-I_C = 150\text{ mA}$, $-I_B = 15\text{ mA}$)	$-V_{BEsat}$	< 0.9	V
($-I_C = 500\text{ mA}$, $-I_B = 50\text{ mA}$)	$-V_{BEsat}$	< 1.1	V
Collector cutoff current ($-V_{CBO} = 60\text{ V}$)	$-I_{CBO}$	< 50	nA
($-V_{CBO} = 60\text{ V}$, $T_{amb} = 150\text{ }^{\circ}\text{C}$)	$-I_{CBO}$	< 50	μA
Emitter cutoff current ($-V_{EBO} = 5\text{ V}$)	$-I_{EBO}$	< 10	mA
DC current gain ($-V_{CE} = 5\text{ V}$, $-I_C = 100\text{ }\mu\text{A}$)	h_{FE}	> 75	-
($-V_{CE} = 5\text{ V}$, $-I_C = 1\text{ mA}$)	h_{FE}	> 25	-
($-V_{CE} = 5\text{ V}$, $-I_C = 100\text{ mA}$)	h_{FE}	100 to 300	-
($-V_{CE} = 5\text{ V}$, $-I_C = 100\text{ mA}$, $T_{amb} = 55\text{ }^{\circ}\text{C}$)	h_{FE}	> 40	-
($-V_{CE} = 5\text{ V}$, $-I_C = 500\text{ mA}$)	h_{FE}	> 70	-

Dynamic characteristics ($T_{amb} = 25\text{ }^{\circ}\text{C}$)

Transition frequency ($-V_{CE} = 10\text{ V}$, $-I_C = 50\text{ mA}$, $f = 100\text{ MHz}$)	f_T	> 150	MHz
Collector-base capacitance ($-V_{CBO} = 10\text{ V}$, $f = 1\text{ MHz}$)	C_{CBO}	< 20	pF
Emitter-base capacitance ($-V_{EBO} = 0.5\text{ V}$, $f = 1\text{ MHz}$)	C_{EBO}	< 110	pF
Switching times: ($-V_{CC} = 30\text{ V}$, $-I_C = 500\text{ mA}$, $-I_{B1} = I_{B2} = 50\text{ mA}$)			
Turn-on time	t_{on}	< 100	ns
Storage time	t_s	< 350	ns
Fall time	t_f	< 50	ns

Total perm. power dissipation versus temperature

$P_{tot} = f(T); V_{CE} = \text{parameter}$

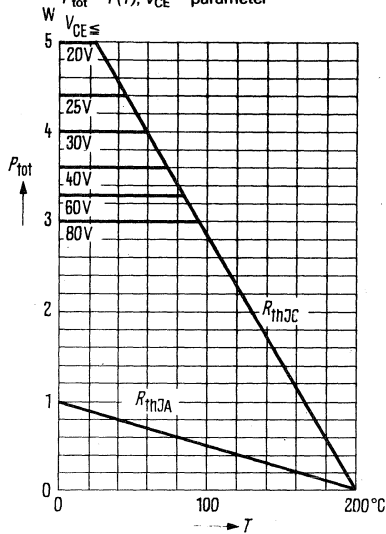

Permissible pulse load
 $r_{thJC} = f(t); v = \text{parameter}$

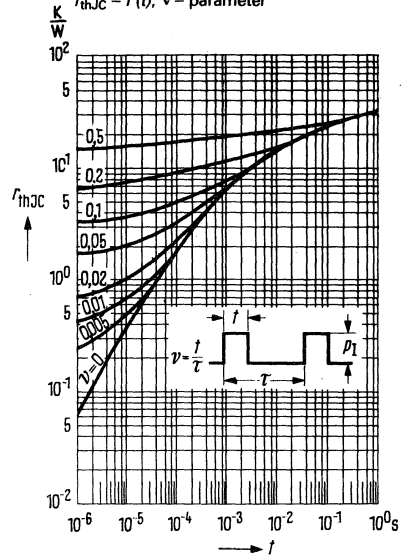

Permissible operating range

$I_C = f(V_{CE}); (T_{case} = 60^{\circ}C)$

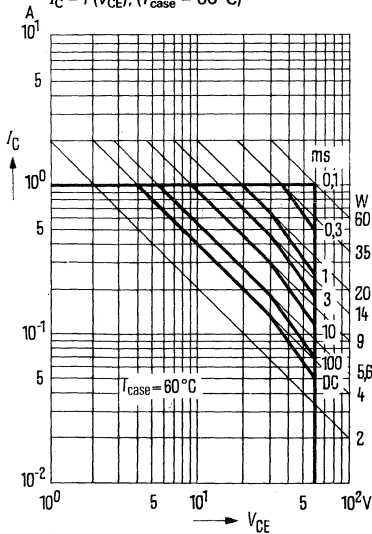

Permissible operating range

$I_C = f(V_{CE}); (T_{case} = 125^{\circ}C)$

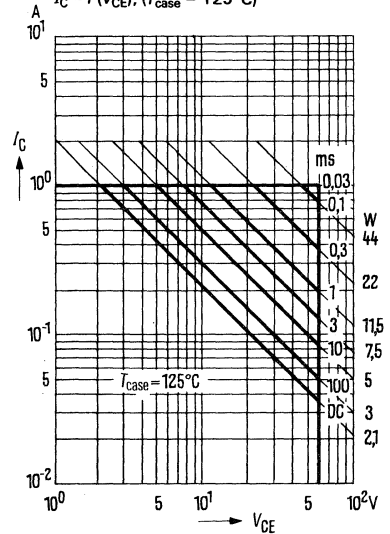

DC current gain $h_{FE} = f(I_C)$
 $V_{CE} = 5 \text{ V}; T_{amb} = \text{parameter}$

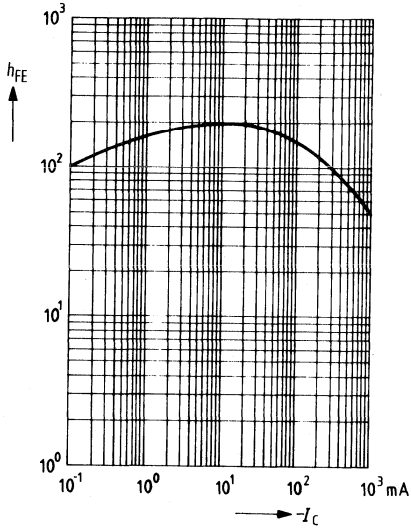

Collector cutoff current versus temperature $I_{CBO} = f(T_{amb})$
 $I_A - V_{CB} = 60 \text{ V}$

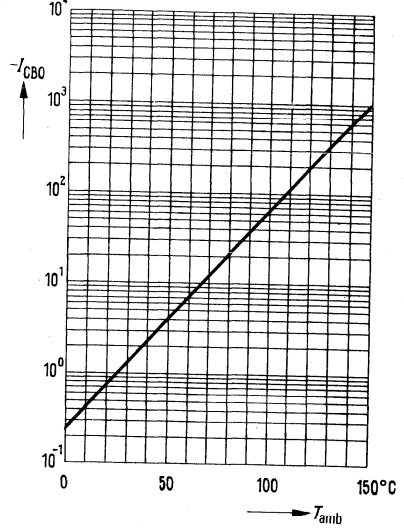

Collector-emitter saturation voltage $V_{CEsat} = f(I_C); h_{FE} = 10$

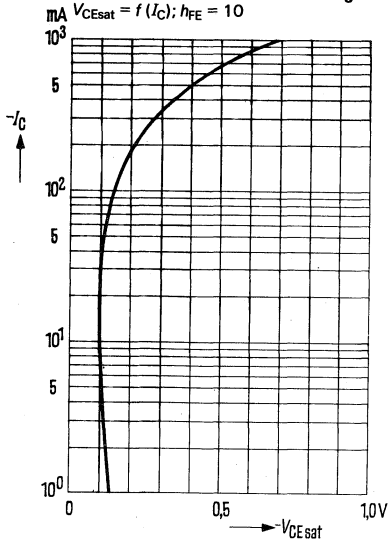

Base-emitter saturation voltage $V_{BEsat} = f(I_C); h_{FE} = 10; V_{CE} = 1 \text{ V}$

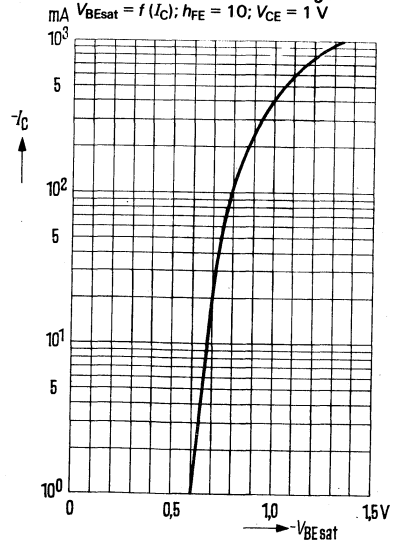

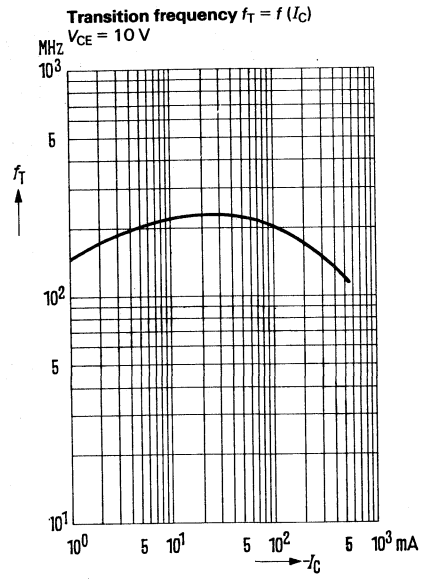
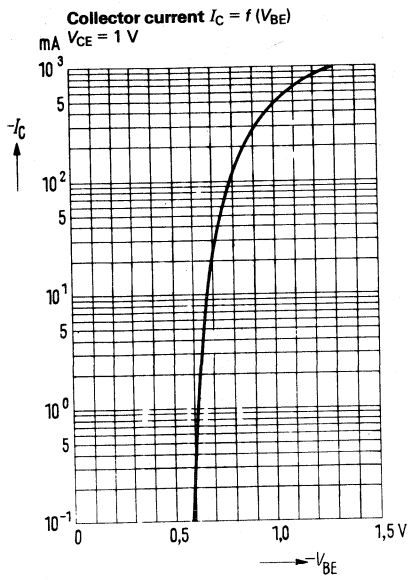

Test circuit for switching times

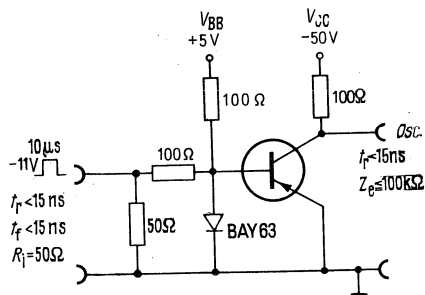

4. List of Sales Offices

Offices

Federal Republic of Germany and Berlin (West)

Siemens AG
Salzufer 6-8
Postfach 110560
1000 Berlin 11
☎ (030) 3939-1, ☎ 1810-278
FAX (030) 3939-2630

Siemens AG
Contrescarpe 72
Postfach 107827
2800 Bremen 1
☎ (0421) 364-1, ☎ 245451
FAX (0421) 364-687

Siemens AG
Lahnweg 10
Postfach 1115
4000 Düsseldorf 1
☎ (0211) 3030-1, ☎ 8581301
FAX (0211) 3030-506

Siemens AG
Gutleutstraße 31
Postfach 4183
6000 Frankfurt 1
☎ (0611) 262-1, ☎ 414131
FAX (0611) 262-2253

Siemens AG
Lindenplatz 2
Postfach 105609
2000 Hamburg 1
☎ (040) 282-1, ☎ 2162721
FAX (040) 282-2210

Siemens AG
Am Maschpark 1
Postfach 5329
3000 Hannover 1
☎ (0511) 199-1, ☎ 922333
FAX (0511) 199-2799

Siemens AG
N 7, 18 (Siemenshaus)
Postfach 2024
6800 Mannheim 1
☎ (0621) 296-1, ☎ 462261
FAX (0621) 296-222

Siemens AG
Richard-Strauss-Straße 76
Postfach 202109
8000 München 2
☎ (089) 9221-1, ☎ 529421-25
FAX (089) 9221-4499

Siemens AG
Von-der-Tann-Straße 30
Postfach 4844
8500 Nürnberg 1
☎ (0911) 654-1, ☎ 622251
FAX (0911) 654-3436,
34614, 3716

Siemens AG
Geschwister-Scholl-Straße 24
Postfach 120
7000 Stuttgart 1
☎ (0711) 2076-1, ☎ 723941
FAX (0711) 2076-706

Siemens Bauteile Service
Lieferzentrum Fürth
Postfach 146
8510 Fürth-Bislohe
☎ (0911) 3001-1, ☎ 623818

Europe

Austria

Siemens Aktiengesellschaft
Österreich
Apostelgasse 12
Postfach 326
A-1031 Wien
☎ (0222) 7293-0, ☎ 131866

Belgium

Siemens S.A.
chaussée de Charleroi 116
B-1060 Bruxelles
☎ (02) 5373100, ☎ 21347

Bulgaria

RUEN,
Büro für Firmenvertretungen und
Handelsvermittlungen bei der
Vereinigung „Interpred“
San Stefano 14/16
BG-1504 Sofia 4
☎ 457082, ☎ 22763

Czechoslovakia

EFEKTIM,
Technisches Beratungsbüro
Siemens AG
Anglická ulice 22, 3. Stock
P.O.B. 1087
CS-12000 Praha 2
☎ 258417, ☎ 122389

Denmark

Siemens A/S
Borupvang 3
DK-2750 Ballerup
☎ (02) 656565, ☎ 35313

Finland

Siemens Osakeyhtiö
Mikonkatu 8
Fach 8
SF-00101 Helsinki 10
☎ (90), 1626-1, ☎ 124465

France

Siemens S.A.
39-47, boulevard Ornano
F-93200 Saint-Denis
(B.P. 109, F-93203 Saint Denis
CEDEX 1)
(für Personalpost: B.P. 122,
F-93204 Saint-Denis CEDEX 1)
☎ (16-1) 8206120, ☎ 620853

Great Britain

Siemens Limited
Siemens House
Windmill Road
Sunbury-on-Thames
Middlesex TW 16 7HS
☎ (09327) 85691, ☎ 8951091

Greece

Siemens Hellas E.A.E.
Voulas 7
P.O.B. 601
Athen 125
☎ (01) 3293-1, ☎ 216291

Hungary

Intercooperation AG,
Siemens Kooperationsbüro
Böszörményi út 9-11
P.O.B. 1525
H-1126 Budapest
☎ (01) 154970, ☎ 224133

Iceland

Smith & Norland H/F
Nóatún 4
P.O.B. 519
Reykjavik
☎ 28322, ☎ 2055

Ireland

Siemens Limited
8, Raglan Road
Dublin 4
☎ (01) 684727, ☎ 5341

Italy

Siemens Elettra S.p.A.
Via Fabio Filzi, K 25/A
Casella Postale 4183
I-20124 Milano
☎ (02) 6248, ☎ 330261

Luxemburg

Siemens Société Anonyme
17, rue Glesener
B.P. 1701
Luxembourg
☎ 49711-1, ☎ 3430

Netherlands

Siemens Nederland N.V.
Wilhelmina van Pruisenweg 26
NL-2595 AN Den Haag
(Postb. 16068,
NL-2500 BB Den Haag)
☎ (070) 782782, ☎ 31373

Norway

Siemens A/S
Østre Aker vei 90
Postboks 10, Veitvet
N-Oslo 5
☎ (02) 153090, ☎ 18477

Poland

PHZ Transactor S.A.
ul. Stawki 2
P.O.B. 276
PL-00-950 Warszawa
☎ 398910, ☎ 815554

Portugal

Siemens S.A.R.L.
Avenida Almirante Reis, 65
Apartado 1380
P-1100 Lisboa-1
☎ (019) 538805, ☎ 12563

Rumania

Siemens birou
de consultajii tehnice
Strada Edgar Quinet Nr. 1
R-70106 Bucuresti 1
☎ 151825, ☎ 11473

Spain

Siemens S.A.
Orense, 2
Apartado 155
Madrid 20
☎ (91) 4552500, ☎ 27769

Sweden

Siemens Aktiebolag
Norra Stationsgatan 69
Box 23141
S-10435 Stockholm 23
☎ (08) 241700, ☎ 11672

Switzerland

Siemens-Albis AG
Freilagerstraße 28
Postfach
CH-8047 Zürich
☎ (01) 2473111, ☎ 52131

Turkey

Etmas Elektrik Tesisatve
Mühendislik A.S.
Meclisi Mebusan Caddesi,
35 Findikli
P.K. 213 Findikli
Istanbul
☎ 452090, ☎ 24233

U.S.S.R.

Ständige Vertretung der
Siemens AG in Moskau
Internationales Postamt
Postfach 77
SU-Moskau G 34
☎ 2027711, ☎ 7413

Yugoslavia

Generalexport
Masarikova 5/XIV
Poštanski fah 223
YU-11001 Beograd
☎ (011) 684866, ☎ 11287

Africa

Algeria

Siemens Algérie S.A.R.L.
3, Viaduc Youghourta
B.P. 224, Alger-Gare
Alger
☎ 615966/67, ☎ 52817

Egypt

Siemens Resident Engineers
33, Dokki Street
P.O.B. 775
Dokki/Cairo
Arab Republik Egypt
☎ 982671, ☎ 321

Ethiopia

Siemens Ethiopia Ltd.
P.O.B. 5505
Addis Ababa
☎ 151599, ☎ 21052

Libya

Siemens Resident Engineers
Socialist People's Libyan Arab
Jamahiriya
P.O.B. 46
Tripoli
☎ 41534, ☎ 20029

Morocco

SETEL
Société Electrotechnique
et de Télécommunications S.A.
Immeuble Siemens
km 1, Route de Rabat
Casablanca-Ain Sebâa
☎ 351025, ☎ 25914

Nigeria

Siemens Nigeria Ltd.
Siemens House
Industrial estate 3 f,
Block A
P.O.B. 304, Apapa
Oshodi (Lagos)
☎ 842502, ☎ 21357

South African Republic

Siemens Limited
Siemens House,
Corner Wolmarans and
Biccard Streets, Braamfontein 2001
P.O.B. 4583
Johannesburg 2000
☎ (011) 7159111, ☎ 58-7721

Sudan

National Electrical
& Commercial Company (NECC)
P.O.B. 1202
Khartoum

Republic of Sudan

☎ 80818, ☎ 642

Tunisia

Sitelec S.A.,
Immeuble Saâdi - Tour C
Route de l'Ariana
Tunis-El Menzah TN
☎ 231526, ☎ 12326

Zaire

Siemens Zaire S.A.R.L.
B.P. 9897
6, rue Limité
Kinshasa 1
☎ 22608, ☎ 21377

America

Argentina

Siemens Sociedad Anónima
Avenida Pte. Julio A. Roca 516
Casilla Correo Central 1232
RA-1067 Buenos Aires
☎ 300411, ☎ 121812

Bolivia

Sociedad Comercial é Industrial
Hansa Limitada
Calle Mercado esquina Yanacocha
Cajón Postal 1402
La Paz
☎ 355317, ☎ 5261

Brazil

Siemens S.A.
Sede Central
Avenida Mutinga, 3650
Pirituba
BR-05110 São Paulo-SP
(Caixa Postal 1375,
BR-01000 São Paulo)
☎ (011) 2610211
☎ 11-23633, 11-23641

Canada

Siemens Electric Limited
7300 Trans-Canada Highway
Pointe Claire, Québec H9R 1C7
(P.O.B. 7300, Pointe Claire,
Québec H9R 4R6)
☎ (514) 6957300,
☎ 5-822778

Chile

Gildemeister S.A.C.,
Area Siemens
Casilla 99-D
Santiago de Chile
☎ 82523,
☎ TRA SGO 392, TDE 40588

Colombia

Siemens S.A.
Carrera 65, No. 11-83
Apartado Aéreo 80150
Bogotá 6
☎ 2628811, ☎ 44750

Ecuador

Siemens S.A.
Avenida América y
Hernández Girón s/n.,
Casilla de Correos 3580
Quito
☎ 454000, ☎ 22190

Mexico

Siemens S.A.
Poniente 116, No. 590
Col. Ind. Vallejo
Apartado Postal 15064
México 15, D.F.
☎ 5670722, ☎ 1772700

Uruguay

Conatel S.A.
Ejido 1690
Casilla de Correo 1371
Montevideo
☎ 917331, ☎ 934

U.S.A.

Siemens Corporation
186 Wood Avenue South
Iselin, New Jersey 08830
☎ (201) 494-1000
☎ WU 844491
TWX WU 7109980588

Venezuela

Siemens S.A.
Apartado 3616
Caracas 101
☎ (02) 2392133, ☎ 25131

Asia

Afghanistan

Afghan Electrical Engineering
and Equipment Limited
Alaudin, Karte 3
P.O.B. 7
Kabul 1
☎ 40446, ☎ 35

Bangla Desh

Siemens Bangladesh Ltd.
74, Diskusha Commercial Area
P.O.B. 33
Dacca 2
☎ 244381, ☎ 5524

Hong Kong

Jebsen & Co., Ltd.
Siemens Division
Prince's Building, 24th floor
P.O.B. 97

Hong Kong

☎ 5225111, ☎ 73221

India

Siemens India Ltd.
Head Office
134-A, Dr. Annie Besant Road, Worli
P.O.B. 6597
Bombay 400018
☎ 379906, ☎ 112373

Indonesia

Representative Siemens AG
Jl. Kebon Sirih 4
P.O.B. 2469
Jakarta Pusat
☎ 35 1051, ☎ 46222

Iran

Siemens Sherkate Sahami Khass
Ave. Ayatolla Talegnani 32,
Siemenshaus
Teheran 15
☎ (021) 614-1, ☎ 212351

Iraq

Siemens Iraq Consulting Office
P.O.B. 3120
Baghdad
☎ 98198, ☎ 2393

Japan

Siemens K.K.
Sales and Administration
Gotanda Fujikura Building,
7th + 9th floor
11-20, Nishigotanda 2-chome,
Shinagawa-ku
P.O.B. 68, Osaki
Tokyo 141
☎ (03) 4902171, ☎ 22808

Korea (Republic)

Siemens Electrical
Engineering Co., Ltd.
C.P.O.B. 3001
Seoul
☎ 7783431, ☎ 23229

Kuwait

Abdul Aziz M. T. Alghanim Co.
& Partners
Abdulla Fahad Al-Mishan Building
Al-Sour Street
P.O.B. 3204
Kuwait, Arabia
☎ 423336, ☎ 2131

Lebanon

Ets. F. A. Kettaneh S.A.
(Kettaneh Frères)
Medawar
P.B. 110242
Beirut
☎ 251040, ☎ 20614

Malaysia

Guthrie Engineering (Malaysia)
Sdn. Bhd.,
Electrical &
Communications Division
17, Jalan Semangat
P.O.B. 30
Petaling Jaya/Selangor
☎ 773344, ☎ 37573

Pakistan

Siemens Pakistan Engineering
Co. Ltd.
Ilaco House, Abdullah Haroon Road
P.O.B. 7158
Karachi 3
☎ 516061, ☎ 2820

Philippines

Engineering Equipment, Inc.
Machinery Division,
Siemens Department
E. Rodriguez Avenue
Murphy, Quezon City
P.O.Box 7160, ADC-MIA 3120
☎ 773011,
☎ RCA 7222382, EEC 3695

Saudi Arabia

Arabia Electric Ltd.
Head Office
P.O.B. 4621
Jeddah
☎ 59521, ☎ 401864

Singapore

Siemens Components PTe. Ltd.
19B - 45B, Jalan Tenteram
Singapore 12
☎ 550811, ☎ RS 21000

Syria

Syrian Import
Export & Distribution
Co., S.A.S. SIEDCO
Port Said Street
P.O.B. 363
Damas
☎ 1343133, ☎ 11267

Taiwan

Delta Engineering Ltd.
42, Hsu Chang Street, 8th floor
P.O.B. 58497
Taipei
☎ 3114731, ☎ 21826

Thailand

B. Grimm & Co., R.O.P.
1643/4, Phetburi Road
(Extension)
G.P.O.B. 66
Bangkok 10
☎ 2524081, ☎ 2614

Yemen (Arab. Republic)

Tihama Tractors
& Engineering Co. Ltd.
P.O.B. 49
Sanaa
Yemen Arab Republic
☎ 2462, ☎ 2217

Australasia

Australia

Siemens Industries Limited
544 Church Street, Richmond
Melbourne, Vic. 3121
☎ (03) 4297111, ☎ 30425

SIEMENS

Transistors · Transistors · Transis
nsistors · Transistors · Transistor
Transistors · Transistors · Transis
nsistors · Transistors · Transistor
Transistors · Transistors · Transis
nsistors · Transistors · Transistor
Transistors · Transistors · Transis
nsistors · Transistors · Transistor
Transistors · Transistors · Transis
nsistors · Transistors · Transistor
Transistors · Transistors · Transis
nsistors · Transistors · Transistor
Transistors · Transistors · Transis
nsistors · Transistors · Transistor
Transistors · Transistors · Transis
nsistors · Transistors · Transistor
Transistors · Transistors · Transis
nsistors · Transistors · Transistor

Ordering-Nr. B/2003-101
Printed in Germany
KG 048015.